

## User's Guide

**CPSMP-130**  
48-VDC Power Supply Module

**CPSMP-140**  
24-VDC Power Supply Module

*13-Slot PointSystem™ Accessory*

The Transition Networks **CPSMP-130** power supply is a 48-VDC slide-in-module that provides optional, redundant power to the CPSMC1310-100 13-slot *PointSystem™* chassis and any installed media converter slide-in-modules and management modules.

The Transition Networks **CPSMP-140** power supply is a 24-VDC slide-in-module that provides optional, redundant power to the CPSMC1320-100 13-slot *PointSystem™* chassis and any installed media converter slide-in-modules and management modules.

The figure below illustrates the components of both types of power supplies:

- An **On/Off switch** that, when set to “I”, allows the power supply module to supply power to the chassis, and any installed modules.
- A **panel fastener screw** that secures the power supply module to the chassis.
- A **power LED** indicator.
- A **handle** for installing and removing the power supply module to/from the chassis.
- A **fuse** installed on the circuit board inside the power supply module's housing.
- A set of three (3) **external power connectors** that distribute power from an external DC outlet to a chassis ground connector, a positive (+) connector, and a negative (-) connector on the power supply module.

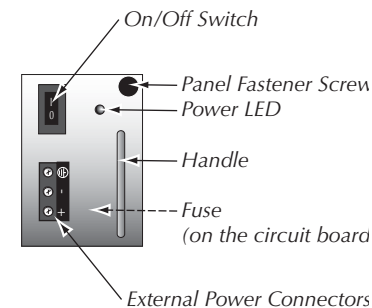

Install the Power Supply Module . . . . .	3
Connect to External Power . . . . .	4
Replace the Power Supply Module . . . . .	6
Replace the Fuse . . . . .	8
Technical Specifications . . . . .	10
Troubleshooting . . . . .	11
Contact Us . . . . .	11
Compliance Information . . . . .	12

## CPSMP-130 & CPSMP-140

READ AND FOLLOW ALL WARNING NOTICES & INSTRUCTIONS MARKED ON THE PRODUCT OR INCLUDED IN THE MANUAL.

**CAUTION:** All installation and service must be performed by qualified service personnel.

**CAUTION:** Wear a grounding device and observe electrostatic discharge precautions when installing or servicing the power supply module. Failure to observe this caution could result in damage to, and subsequent failure of, the power supply module.

### The Power Supply Module in the 13-Slot Chassis

#### CPSMP-130 Power Supply (48-VDC)

The CPSMP-130 power supply module may replace an existing 48-VDC power supply or be installed in the second installation slot (see drawing below) of the *PointSystem*™ 13-slot chassis to become the optional, redundant power supply.

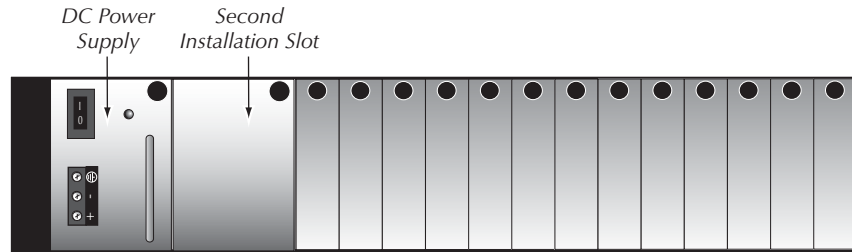

#### CPSMP-140 Power Supply (24-Volt)

The CPSMP-140 power supply module may replace an existing 24-VDC power supply or be installed in the second installation slot (see drawing above) of the *PointSystem*™ 13-slot chassis to become the optional, redundant power supply.

**NOTE:** Both the CPSMP-130 and the CPSMP-140 DC power supply modules may be installed as the redundant power supply in **any** of the three *PointSystem*™ 13-slot chassis:

- CPSMC1300-100 (AC chassis)
- CPSMC1310-100 (48-VDC chassis)
- CPSMC1320-100 (24-VDC chassis)

For more information, see the user's guide for the CPSMC13xx-100 13-slot chassis on-line at: [www.transition.com](http://www.transition.com).

**WARNING:** Do NOT connect the power supply module to the external power source before installing it into the chassis. Failure to observe this caution could result in equipment damage and/or personal injury or death.

## Install the Power Supply Module

**CAUTION:** Ensure that the power supply module has been disconnected from the external power source and the module's On/Off switch has been set to "0". Failure to observe this caution could result in damage to, and subsequent failure of, the power supply module.

**NOTE:** The power supply module may be "hot swapped" (i.e., installed in the chassis while the chassis is in operation) **provided the module to be installed has been disconnected from its external power source and the module's On/Off switch has been set to "0"**.

To install the power supply module into the *PointSystem*™ chassis:

1. Loosen the screw that secures the protective plate to the chassis and pull the plate away from the chassis.

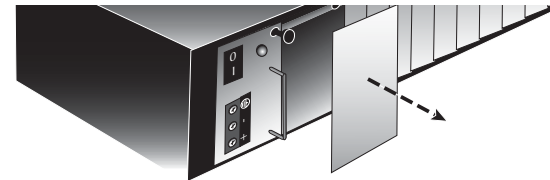

2. Set the On/Off switch on the power supply module to "0".
3. Carefully slide the power supply module into the installation slot, aligning the module with the installation guides.

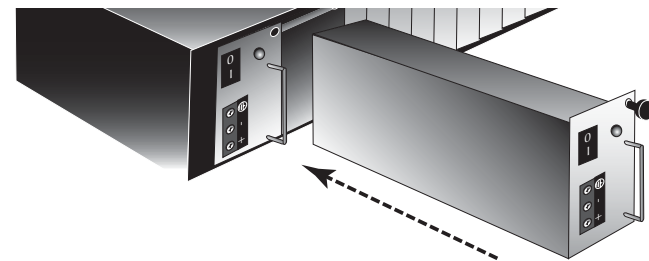

4. Ensure that the power supply module is firmly seated inside the chassis.
5. Rotate the attached panel fastener screw clockwise to secure the power supply module to the chassis.

## Connect to External Power

**CAUTION:** Ensure that external power source is **NOT** powered and that the **On/Off switch on the power supply module is set to “0”** when connecting to the external power source. Failure to observe this caution could result in damage to, and subsequent failure of, the power supply module.

### 48-VDC power supply

- This product is intended to be used in a restricted access location. Proper earthing (grounding) is required to ensure safe operation and to comply with customer installation requirements and local electrical codes. Prior to installation, use a voltmeter/ohmmeter to check the wiring for the presence of earth ground.
- A readily accessible disconnect device as part of the building installation shall be incorporated into the fixed wiring. The disconnect device (a 48 VDC, 15 or 20A circuit breaker or switch) must be included in the ungrounded supply conductor. Overcurrent protection must be a 48 VDC, 15 or 20A fuse or circuit breaker.

### 24-VDC Power Supply

- This product is intended to be used in a restricted access location. Proper earthing (grounding) is required to ensure safe operation and to comply with customer installation requirements and local electrical codes. Prior to installation, use a voltmeter/ohmmeter to check the wiring for the presence of earth ground.
- A readily accessible disconnect device as part of the building installation shall be incorporated into the fixed wiring. The disconnect device (a 24 VDC, 15 or 20A circuit breaker or switch) must be included in the ungrounded supply conductor. Overcurrent protection must be a 24 VDC, 15 or 20A fuse or circuit breaker.

## Connect to External Power -- Continued

To power the CPSMP-130 or the CPSMP-140 power supply module:

1. Set the On/Off switch on the power supply module to “0”.
2. Verify that the external power source is **NOT** powered.
3. Connect the positive (+) terminal to the external power connector marked “+”. Turn the terminal screw clockwise to secure.
4. Connect the negative (-) terminal to the external power connector marked “-”. Turn the terminal screw clockwise to secure.
5. Connect the ground terminal to the external power connector marked “chassis ground”. Turn the terminal screw clockwise to secure.
6. Set the power supply module power switch to “1”.
7. Verify that the power supply module is powered by observing the illuminated power LED.

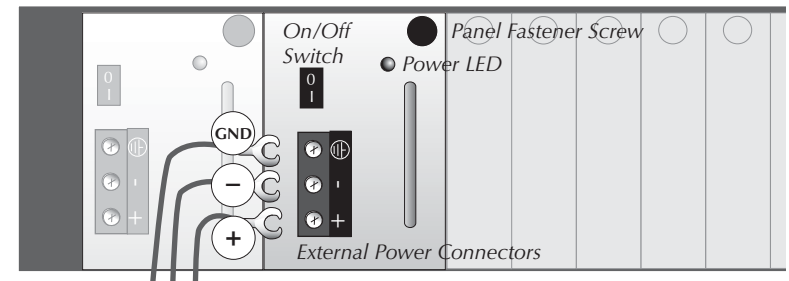

**WARNING:** Do NOT connect the power supply module to the external power source before installing it into the chassis. Failure to observe this caution could result in equipment damage and/or personal injury or death.

## Replace the Power Supply Module

**CAUTION:** Ensure that the power supply module has been disconnected from the external power source and the module's On/Off switch has been set to "0". Failure to observe this caution could result in damage to, and subsequent failure of, the power supply module.

**NOTE:** The power supply module may be "hot swapped" (i.e., replaced while the chassis is in operation) **provided the module to be replaced has been disconnected from its external power source and the module's On/Off switch has been set to "0"**.

To replace the CPSMP-130 or the CPSMP-140 power supply module:

1. Set the On/Off switch on the power supply module to "0".
2. Verify that the external power source is **NOT** powered.
3. Disconnect the positive(+) terminal from the external power connector marked "+".
4. Disconnect the negative (-) terminal from the external power connector marked "-".
5. Disconnect the ground terminal from the external power connector marked "chassis ground".
6. Rotate the attached panel fastener screw counter-clockwise.

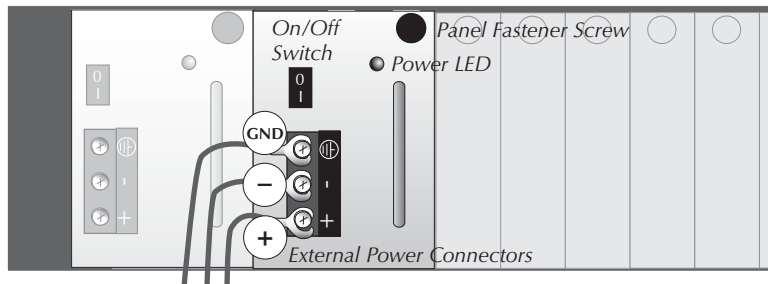

7. Carefully slide the power supply to be replaced out of the chassis.

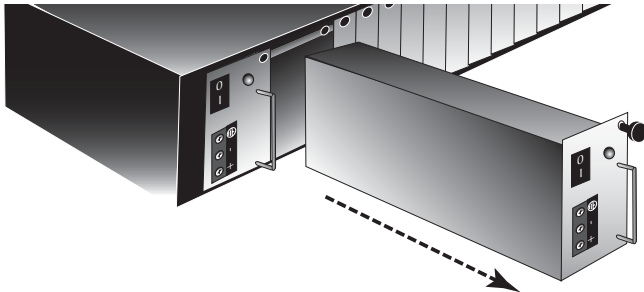

## Replace the Power Supply Module -- Continued

8. Carefully slide the replacement power supply module into the installation slot, aligning the module with the installation guides.

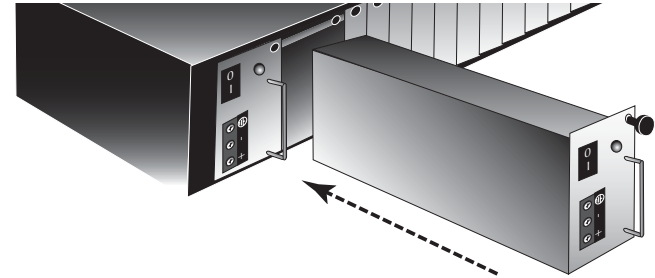

9. Ensure that the power supply module is firmly seated inside the chassis.
10. Rotate the attached panel fastener screw clockwise to secure the power supply module to the chassis.
11. See the "Connect to External Power" section (page 5) for instructions on re-connecting the power supply module to the external power source.

## Replace the Fuse

**CAUTION:** Ensure that the power supply module has been disconnected from the external power source and the module's On/Off switch has been set to "0". Failure to observe this caution could result in damage to, and subsequent failure of, the power supply module.

**NOTE:** The power supply module may be "hot swapped" (i.e., serviced while the chassis is in operation) **provided the module to be serviced has been disconnected from its external power supply and the module's On/Off switch has been set to "0"**.

To replace the fuse in the CPSMP-130 or CPSMP-140 power supply module:

1. Set the On/Off switch on the power supply module to "0".
2. Verify that the external power source is **NOT** powered.
3. Disconnect the positive (+) DC terminal from the external power connector marked "+".
4. Disconnect the negative (-) DC terminal from the external power connector marked "-".
5. Disconnect the ground terminal from the external power connector marked "chassis ground".

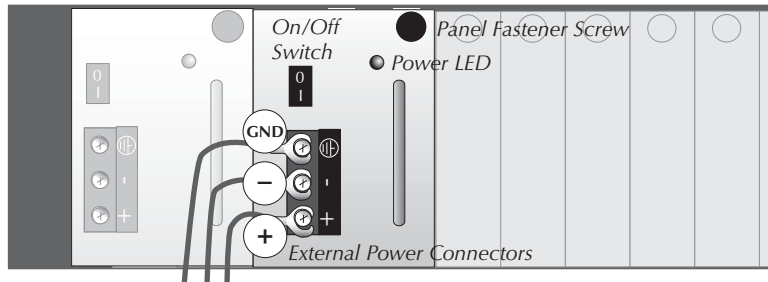

6. Rotate the attached panel fastener screw counter-clockwise.
7. Carefully slide the power supply module out of the chassis.

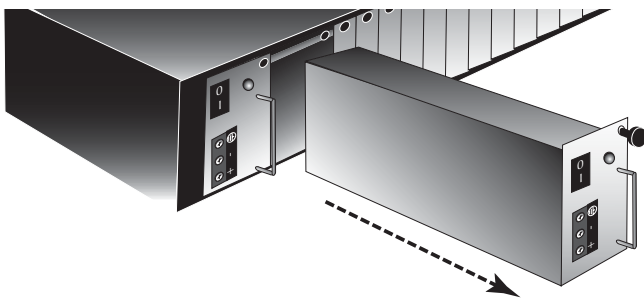

**WARNING:** Do **NOT** connect the power supply module to the external power source before installing it into the chassis. Failure to observe this caution could result in equipment damage and/or personal injury or death.

8. Remove the four (4) screws that secure the panel to the module (see the drawing below) and remove the panel from module.

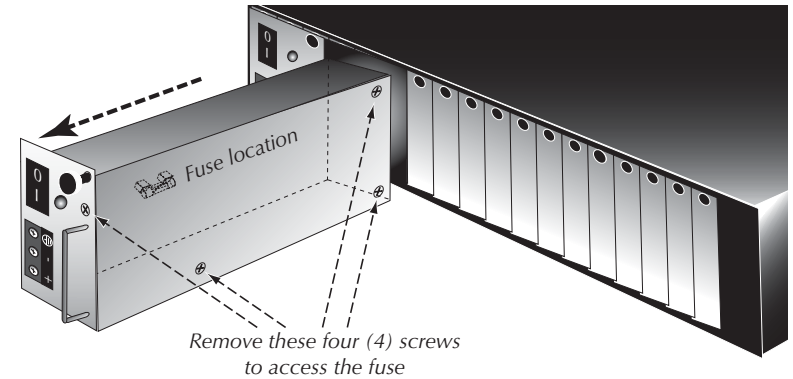

9. The fuse is located inside the power supply module on the circuit board. Remove the fuse from the fuse holder.
10. Install a same **size and rating** replacement fuse in the fuse holder.
11. Replace the panel to the power supply module and secure it in place with the four (4) screws.
12. Carefully slide the power supply module into the installation slot, aligning the module with the installation guides.

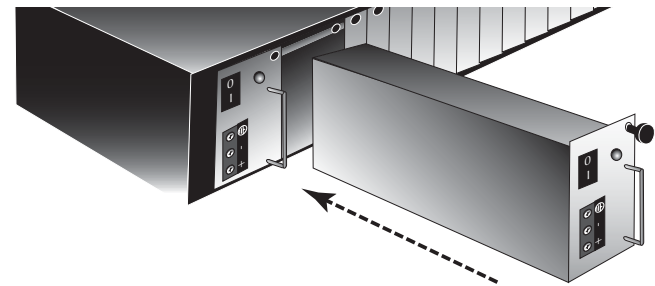

13. Ensure that the power supply module is firmly seated inside the chassis.
14. Rotate the attached panel fastener screw clockwise to secure the power supply module to the chassis.
15. See the "Connect to External Power" section (page 5) for instructions on re-connecting the power supply module to the external power source.

## Technical Specification

For use with Transition Networks model CPSMP-130 or CPSMP-140 or equivalent.

<b>Standards</b>	UL Listed; FCC & CISPR Class A; CE Mark
<b>Dimensions</b>	3.4" x 2.5" x 11.0" (86 mm x 64 mm x 279 mm)
<b>Weight</b>	1.8 lb (0.8 kg) (approximate)
<b>CPSMP-130</b>	Power Input: 48VDC (38 to 58VDC) @ 2.63Amp (typical for a fully-loaded chassis)  Power Output: +12 VDC @ 12.5 Amp (maximum)
<b>CPSMP-140</b>	Power Input: 24VDC (20 to 31VDC) @ 4.83 Amp (typical for a fully-loaded chassis)  Power Output: +12 VDC @ 8.3 Amp (maximum)
<b>Fuse</b>	6.3Amp / 250V
<b>MTBF</b>	520,441 hours (MIL217F2 V5.0) (MIL-HDBK-217F) 1,087,866 hours (Bellcore7 V5.0)
<b>Environment</b>	Tmra**: 0 to 50°C (32 to 122°F) Storage Temp: -20 to 85°C (-4 to 185°F) Humidity: 10 to 90%, non condensing Altitude: 0 to 10,000 feet
<b>Warranty</b>	Lifetime

\*\*Manufacturer's rated ambient temperature: Tmra range for these power supply modules depend on the physical characteristics and the installation configuration of the Transition Networks *PointSystem*™ chassis in which this slide-in-module will be installed.

For the most up-to-date information on the CPSMP-130 and CPSMP-140 power supply modules, view the user's guide on-line at: [www.transition.com](http://www.transition.com).

## Troubleshooting

If the power supply module fails, isolate and correct the failure by determining the answers to the following questions and then taking the indicated action:

### 1. Is the power LED on the power supply module illuminated?

#### NO

- Is the power supply module inserted properly into the chassis?
- Is the power supply module properly connected to the external power source?
- Does the external power source provide power?
- Contact Technical Support: US/Canada: 1-800-260-1312, International: 00-1-952-941-7600.

#### YES

- Proceed to step 2.

### 2. Is the fuse on the power supply intact?

#### NO

- **CAUTION: See the "Replacing the Fuse" section (page 8) in this user's guide for the proper method for replacing the fuse to the power supply module.**
- Contact Technical Support: US/Canada: 1-800-260-1312, International: 00-1-952-941-7600.

#### YES

- Contact Technical Support: US/Canada: 1-800-260-1312, International: 00-1-952-941-7600.

## Contact Us

### Technical Support

Technical support is available 24 hours a day.

US and Canada: **1-800-260-1312**

International: **00-1-952-941-7600**

### Transition Now

Chat live via the Web with Transition Networks Technical Support.

Log onto [www.transition.com](http://www.transition.com) and click the **Transition Now** link.

### Web-Based Seminars

Transition Networks provides seminars via live web-based training.

Log onto [www.transition.com](http://www.transition.com) and click the **Learning Center** link.

### E-Mail

Ask a question anytime by sending an e-mail to our technical support staff.

[techsupport@transition.com](mailto:techsupport@transition.com)

### Address

Transition Networks, 6475 City West Parkway, Minneapolis, MN 55344, USA  
telephone: 952-941-7600, toll free: 800-526-9267, fax: 952-941-2322



# Compliance Information

UL Listed; C-UL Listed (Canada); CE Mark  
CISPR22/EN55022 Class A

## FCC Regulations

This equipment has been tested and found to comply with the limits for a Class A digital device, pursuant to part 15 of the FCC rules. These limits are designed to provide reasonable protection against harmful interference when the equipment is operated in a commercial environment. This equipment generates, uses, and can radiate radio frequency energy and, if not installed and used in accordance with the instruction manual, may cause harmful interference to radio communications. Operation of this equipment in a residential area is likely to cause harmful interference, in which case the user will be required to correct the interference at the user's own expense.

## Canadian Regulations

This digital apparatus does not exceed the Class A limits for radio noise for digital apparatus set out on the radio interference regulations of the Canadian Department of Communications. Le présent appareil numérique n'émet pas de bruits radioélectriques dépassant les limites applicables aux appareils numériques de la Class A prescrites dans le Règlement sur le brouillage radioélectrique édicté par le ministère des Communications du Canada.

## European Regulations

**Warning** This is a Class A product. In a domestic environment this product may cause radio interference in which case the user may be required to take adequate measures.

**Achtung!** Dieses ist ein Gerät der Funkstörgrenzwertklasse A. In Wohnbereichen können bei Betrieb dieses Gerätes Rundfunkstörungen auftreten, in welchen Fällen der Benutzer für entsprechende Gegenmaßnahmen verantwortlich ist.

**Attention!** Ceci est un produit de Classe A. Dans un environnement domestique, ce produit risque de créer des interférences radioélectriques, il appartiendra alors à l'utilisateur de prendre les mesures spécifiques appropriées.

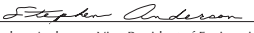
		<b>Declaration of Conformity</b>	
Name of Mfg:	<b>Transition Networks</b>	6475 City West Parkway, Minneapolis MN 55344 USA	
Model:	<b>Redundant Power Supply</b>		
Part Number(s):	<b>CPSMP-130, CPSMP-140</b>		
Regulation:	<b>EMC Directive 89/336/EEC</b>		
Purpose: To declare that the <b>CPSMP-130</b> and <b>CPSMP-140</b> to which this declaration refers are in conformity with the following standards. EN 55022:1988 + A1:2000 Class A; FCC Part 15 subpart B; UL 1950			
<i>I, the undersigned, hereby declare that the equipment specified above conforms to the above Directive(s) and Standard(s).</i>			
		June 8, 2001	
Stephen Anderson, Vice-President of Engineering		Date	

## Trademark Notice

All trademarks and registered trademarks are the property of their respective owners.

## Copyright Restrictions

© 2001, 2004 Transition Networks. All rights reserved. No part of this work may be reproduced or used in any form or by any means - graphic, electronic, or mechanical - without written permission from Transition Networks.

Printed in the U.S.A.

**33213.B**

## Free Manuals Download Website

<http://myh66.com>

<http://usermanuals.us>

<http://www.somanuals.com>

<http://www.4manuals.cc>

<http://www.manual-lib.com>

<http://www.404manual.com>

<http://www.luxmanual.com>

<http://aubethermostatmanual.com>

Golf course search by state

<http://golfingnear.com>

Email search by domain

<http://emailbydomain.com>

Auto manuals search

<http://auto.somanuals.com>

TV manuals search

<http://tv.somanuals.com>