

---

# TRIAX STR 333

---

## Digital Combo Receiver PREMIUM DUAL PVR



## Use Manual



# General Safety

## Cautions

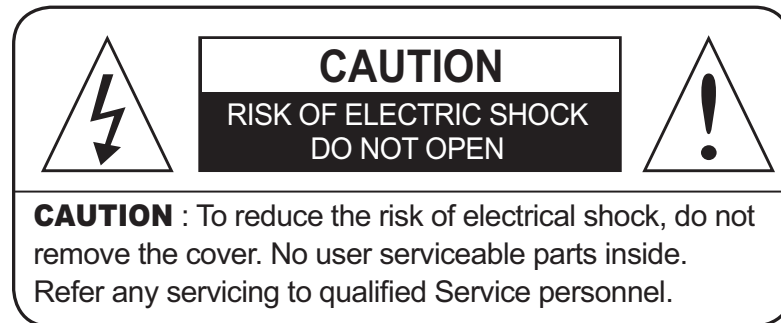

Read this manual carefully before using the product. The cautions described below contain important information about safety, and are categorized into: **Danger**, **Warning** and **Notice**. The company will not take any responsibility for accidents or damage resulting from careless handling by the user.



### Danger

If the user mishandles the product, there is a risk of loss of life or critical injury.

- Connect the power cord only to A/C outlets as specified by the user manual or product specification. If the power cord is connected to a non-specified A/C outlet, it could result in fire or electric shock.
- The product must not be exposed to water or liquid of any sort, or be exposed to drips or splashes. It could result in fire or electric shock.
- Do not place heavy objects, including the product itself, on top of the power cord. If it is damaged, it could result in fire or electric shock.
- Do not place metal objects on top of the apparatus. If metal objects fall into the apparatus, it could result in fire or electric shock.
- Do not repair, disassemble or modify this apparatus yourself. It might cause fire or electric shock. If internal checking or maintenance is needed, please contact your service center or agency.
- Do not block or cover any ventilation opening. A fire might result from overheating.
- Turn off and unplug the power as quickly as possible during electric storms. Failure to do so could result in fire or electric shock.
- Remove the antenna's power plug from the outlet as quickly as possible during electric storms. Failure to do so could result in fire or electric shock.
- Do not drop the apparatus (for example by putting it in a place where it may fall) or subject it to impact. The product might be damaged. If it is damaged, please turn off the power and remove the plug from the power outlet, or fire or electric shock may result.
- Never touch the power cord with wet hands. It could result in an electric shock.

## Cautions



### Warning

If the product is mishandled, the user might receive a serious or minor injury. Damage or loss to the user's property might also result.

- The product must not be exposed to water or liquid. If the apparatus is exposed to drips or splashes, it might cause a problem that cannot be repaired.
- Do not repair, disassemble or modify this apparatus yourself. It might be seriously damaged, possibly beyond repair.
- Turn off the power and unplug the power cord as quickly as possible during electric storms. They might damage the apparatus.
- Remove the antenna's power plug from the outlet as quickly as possible during electric storms, or the apparatus might be damaged.
- Data recorded in the HDD might be lost due to a shock, lightning or electricity failure. The user must back up his or her own data, and the company does not take any responsibility for failure to do so.



### Notice

If the product is mishandled, it might cause minor damage.

- If the apparatus becomes marked, clean it gently with a soft cloth or towel. Never use chemical solvents such as benzene, thinner, acetone or other solvents. The surface of the apparatus might become discolored and the paint might peel.
- Do not place or keep the apparatus in the following situations. Doing so might cause problems.
  - where it is too hot or cold.
  - where there is high humidity.
  - where there are excessive temperatures, for example in front of airconditioners or heating vents.
  - where there is dust or soot.
  - in confined areas where the heat cannot be released.
  - where it is exposed to direct sunlight.
- Turn the apparatus off or unplug the power cord if it is to remain unused for a long period of time.
- Do not place heavy objects on top of this apparatus. It might cause malfunction or damage.
- If the apparatus is so seriously damaged that it cannot be repaired, or has stopped working altogether, dispose of it properly in accordance with the local laws or regulations in your area.

# Contents

General Safety.....	2
1. Functions and Installation .....	5
1.1 Remote Control Unit.....	5
1.2 Front Panel.....	6
1.3 Rear Panel .....	6
1.4 CAM(Conditional Access Module) and Smart Card .....	7
1.5 Connecting and Installation .....	8
2. Easy Installation.....	10
3. Basic Operation.....	12
4. Main Menu Guide.....	18
4.1 PVR - Record & Play.....	18
4.2 Edit Channel List .....	24
4.3 Program Guide.....	26
4.4 System Setting .....	27
4.5 Utility (option) .....	33
4.6 Common Interface.....	34
5. Troubleshooting.....	34
6. Technical Specifications .....	35

# 1. Functions and Installation

## 1.1 Remote Control Unit

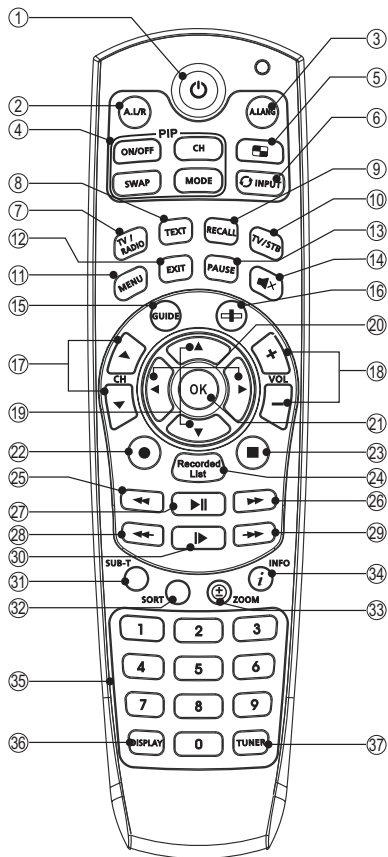

1. **STAND BY** To switch between operation and stand by mode.
2. **A.L/R** To select the sound mode. (Mono, Left, Right, Stereo) To display the reserved list. (Option)
3. **A/LANG** To select the audio language.
4. **PIP**
  - ON/OFF To turn the PIP screen on/off.
  - CH To change the PIP screen channel. If you press the button, the PIP Channel List will be shown.
  - SWAP To swap the main screen for the PIP screen.
  - MODE To change or modify the size or location of the PIP.
5. **Multichannel button** Multi video pop-up window will appear.
6. **INPUT** Selection of external input. (Option)
7. **TV/RADIO** To switch between TV and Radio.
8. **TEXT** To see the teletext by OSD. (Option)
9. **RECALL** To return to the previous channel.
10. **TV/STB** To switch between TV and STB receive mode.
11. **MENU** To display the Main Menu on the screen or return to the previous menu.
12. **EXIT** To return the normal viewing mode from a menu.
13. **PAUSE** To pause or play video.
14. **MUTE** To enable or disable audio.

15. **GUIDE** To display the TV/RADIO program guide.
16. **Progress bar** To display the book mark banner.
17. **CHANNEL UP/DOWN** To change channel up and down.
18. **VOLUME UP/DOWN** To increase or decrease the volume.
19. **Up/Down** To move up or down on the menu.
20. **Left/Right** To move left or right on the menu. To increase or decrease the volume.
21. **OK** To confirm your choice.
22. **Record** Saves the current channel to the HDD.
23. **Stop** Used for stopping play.
24. **Recorded List** To open the File List screen.
25. **Rew** Used for rewinding.
26. **FF** Used for fast-forwarding.
27. **Play/Pause** Used for playing or pausing files.
28. **Quick Replay** To go to the previous screen.
29. **Quick Forward** To go to the next screen.
30. **Slow** Used for viewing the screen in slow motion.
31. **SUB-T(Red)** To enable or disable subtitle or change the channel list mode.
32. **SORT(Green)** To sort channel list.
33. **ZOOM(Yellow)** Enlarge the current picture.
34. **INFO(Blue)** To display the information box on the screen.
35. **NUMERIC BUTTONS** To select the channel and enter the channel edit and PIN code.
36. **DISPLAY** To open the Display screen of the System Setting menu.
37. **TUNER** To switch between Terrestrial and Satellite mode. (Only COMBO)

### Note

- When inserting batteries, make sure that the polarity (+/-) is correct.
- The design of the Remote Control Unit may be changed without any notice in advance.

## 1.2 Front Panel

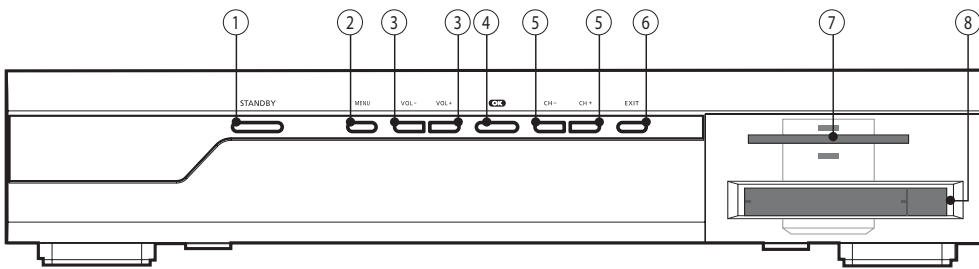

1. **STAND BY(POWER)**  
Switch the receiver power "ON" or "OFF".
2. **MENU**  
To see main menu.
3. **VOL -/+**  
To turn the volume -/+ or select a sub-menu item.
4. **OK**  
To select a program, a highlighted line or parameter value.
5. **CH -/+( Program ▲/▼)**  
Channel -/+ or select item of sub-menu.
6. **EXIT**  
Exit from parameter and cancel selected function.
7. **Smartcard Slot**  
1 Slot for smart card.
8. **Cam Slot (Option)**  
2 Slot for Common Interface CAM with smart card.

## 1.3 Rear Panel

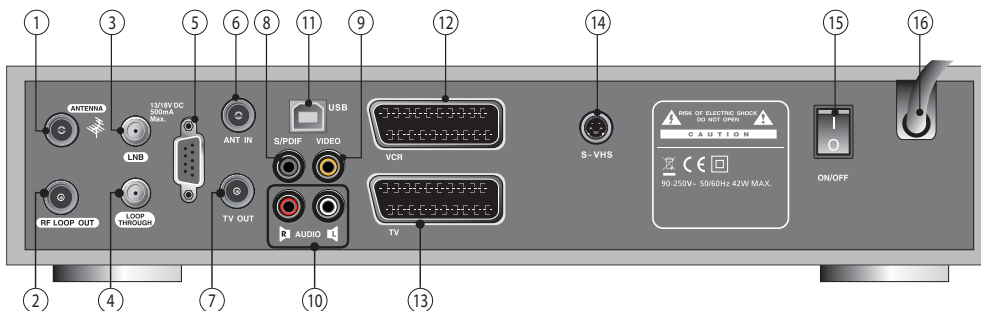

1. **ANTENNA**  
Input connector from terrestrial antenna.
2. **RF LOOP OUT**  
Looped through antenna RF signal output. Used to connect to ANT IN.
3. **LNB**  
Input connector from LNB.
4. **LOOP THROUGH**  
Output for SAT IF looped through signal.
5. **RS-232**  
To connect to a personal computer for software upgrade.
6. **ANT IN**  
RF antenna input.
7. **TV OUT**  
To connect a TV via a coaxial cable.
8. **S/PDIF(Coaxial/Optical)**  
To connect a digital amplifier output.
9. **VIDEO**  
Video connection port to the TV or other equipment.
10. **AUDIO**  
Audio connection port to the TV or other equipment.
11. **USB port**  
To connect the USB cable to the PC.
12. **SCART for VCR**  
Connect this port to the VCR via SCART cable.
13. **SCART for TV**  
Connect this port to the TV via SCART cable.
14. **S-VHS**  
Video connection port to a TV or other equipment via super video.
15. **POWER Switch**  
Provide power to the main unit.
16. **POWER Supply**  
90 ~ 250V AC, 50/60Hz.

### Note

The design of the Front/Rear Panel may be changed without any notice in advance.

## 1.4 CAM(Conditional Access Module) and Smart Card (Option)

### Caution

**Please do not plug in the main power supply cord until you have finished all of the connections!**

Although some TV and radio channels are free to view, you must subscribe to most TV and radio/music channels and a Conditional Access component is required.

If you want to enjoy watching scrambled broadcasting channels, you need to purchase the CAMs and smart cards from a service provider's sales department.

However, broadcasting channels from multiple service providers call for multiple CAMs and Smart cards.

Receivers which have only the CAMs and smartcards provided by the one service provider can show several broadcasting channels of the provider.

Please refer to manuals provided by service providers for details because the CAM and smartcards are featured with unique menus, apart from menus given by the receiver.

Watching "Free-To-Air" channel is available regardless of the CAM and smart cards.

As service providers download new information to smart cards if necessary, those who have CAMs and smart cards should always put the smart cards in proper slots.

### Inserting a Smart card

A Smart card looks similar to a credit card and entitles you to view and listen to all the channels you choose to subscribe to.

The Smart card slot on the receiver can be used for Smart cards only.

1. Open the right-hand cover on the front panel of the receiver.
2. Hold the Smart card horizontally with the electronic chip (small square-shaped, gold in colour) facing upwards.
3. Insert the Smart card into the top slot.

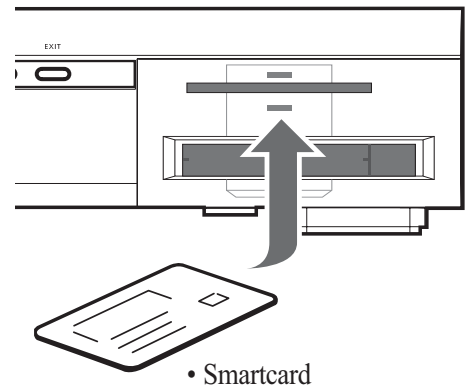

### Inserting the CI (Common Interface) Module

Your digital satellite receiver is equipped with a slot for the Common Interface (CI).

1. Open the right-hand cover on the front panel of the digital satellite receiver.
2. Insert the smart card into the CI-Module, and the CI-Module into the slot.

### Note

- CI and CAS embeded model only.

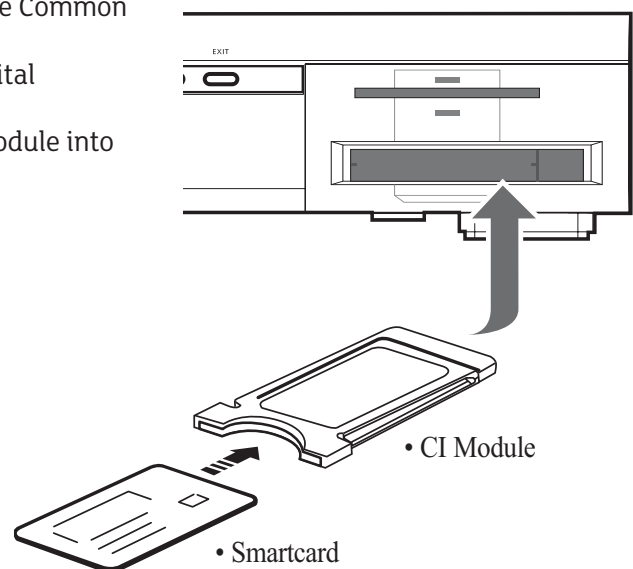

## 1.5 Connecting and Installation

### 1.5.1 How to connect the receiver to various other systems

There are several ways of connecting the receiver to your TV, VCR and/or Hi-Fi SYSTEM. Consult your local supplier for assistance in setting-up your system that is best suited to your requirements.

### 1.5.2 To Connect Satellite and Terrestrial Antenna (Only Combo)

- Connect one end of RF cable to the ANT IN on the back of the receiver and the other end to a terrestrial antenna connection or the jack for the public antenna on the wall.

#### ◆ DiSEqC 1.0

- Connect the coaxial cable from the LNB to the LNB IN jack on back of the receiver.

#### ◆ DiSEqC 1.2 Motor

- Connect one end of your coaxial cable to the LNB IN connector on the receiver and the other end to the REC or Receiver connector on the DiSEqC 1.2 motor.
- Connect the coaxial cable from the LNB to the LNB connector on the DiSEqC 1.2 motor.

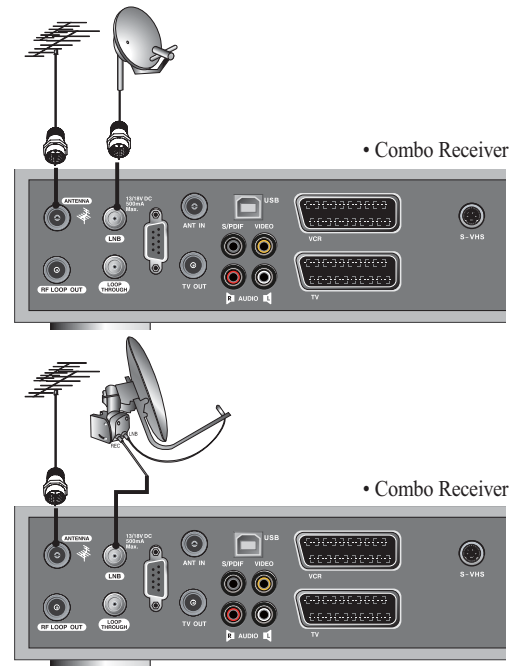

### 1.5.3 Connect the receiver to a TV set

- Connect the receiver to a TV set with SCART, if your TV set is equipped for it. Alternatively you can use A/V, TV out (UHF) or S/Video jacks.

### 1.5.4 Connect the receiver to a VCR

- Connect the SCART jack from the VCR to the back of the receiver.

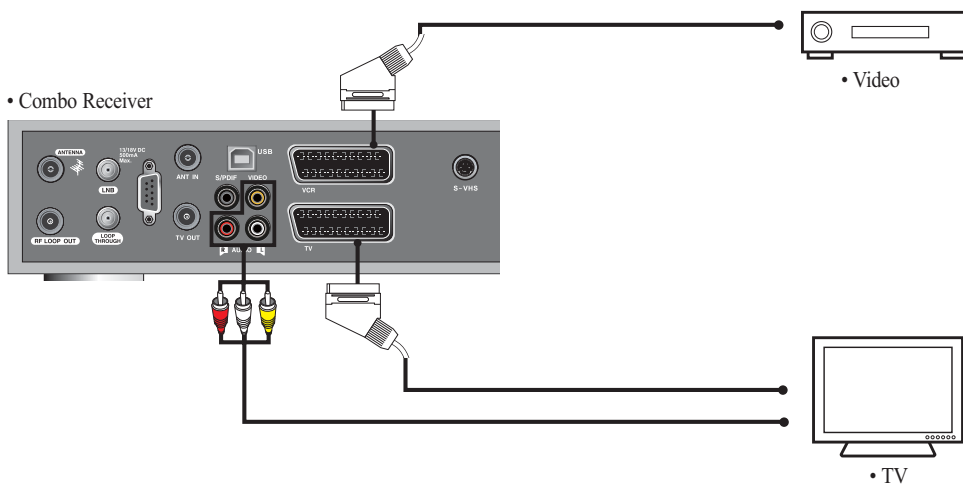



## 1.5 Connecting and Installation

### 1.5.5 Connect the receiver to a Hi-Fi System

- Connect a RCA stereo cable from the AUDIO L/R jacks, S/PDIF on the receiver to the LINE, AUX, SPARE or EXTRA input jacks on your Hi-Fi System.

### 1.5.6 Connect the receiver to a Digital Audio System

- If you have a DAC with S/PDIF coaxial cable input, you can connect the receiver with it to enjoy higher quality sound. Connect S/PDIF coaxial cable to a digital amplifier.

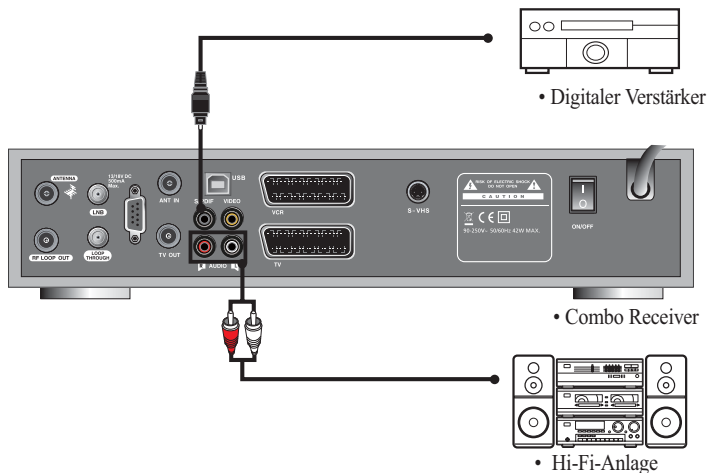

### 1.5.7 Connecting to the PC

- Turn the receiver and your PC on.
- Connect the receiver to your PC with the enclosed USB cable.
- Open the PVR menu and select CONNECT USB.
- To confirm, click the start button and then click Program → Accessories → Windows Explorer.
- You can check that the new drive is installed in your computer.  
The factory drive name is PVR HDD.

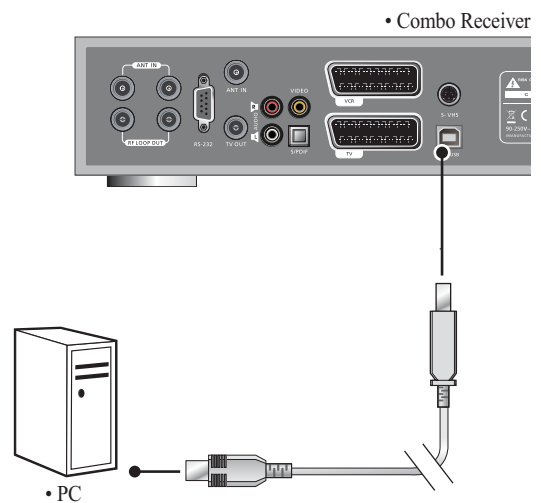

### Note

- Connect the cable with input jack on STB properly shown in the picture.
- Please be careful when you upload or download files while the receiver is connected to a PC with the USB cable. The data recorded in the HDD may be lost if the PC's power is turned off, or if the USB cable is unplugged while uploading or downloading files.

### 1.5.8 Loop Through

- If you have another analogue or digital receiver and you wish to use the same LNB then you can connect it via the loop through. Connect one end of the coaxial cable to the Loop Through on the receiver and connect the other end to the LNB IN on your second receiver.

## 2. Easy Installation

### 2.1 Menu Application

Press the **MENU** button on the remote control unit.  
You will see the “Main Menu” on the screen.

- Default PIN code is "0000"
- You can move into the desired submenu using the **UP/DOWN/LEFT/RIGHT** buttons.
- You should enter the PIN code in order to move into the corresponding submenu in case of the Installation, the Edit Channel List or the System Setting.
- Press the **OK** button to confirm your selection.
- Press the **MENU** button to return to previous menu. Or press the **EXIT** button to quit the Menu system completely.

### 2.2 Easy Installation

Before you watch the television or radio program, you must perform the installation procedure first. Therefore you will see only “Easy Installation Menu” at first when you plug into your system. The Easy Installation gives you the convenience of selecting various languages, adjusting the time and channel search.

- **Automatic Installation by “Easy Installation”**  
The Installation Wizard is a user-friendly method assuring the easy set-up of the receiver by the new user.
- **System Connection**  
Connect the receiver to all peripheral devices such as the TV, Audio and Video etc.
- **Power On**  
Power switch is located on the back of the receiver.  
The power cord of the receiver should be connected to a wall outlet.  
Turn on the power of the receiver and other devices.  
Press the **STANDBY** button on the front of the receiver or on the remote control.
- **Power Off**  
When you press the **STAND BY** button again. The receiver will display “OFF”.

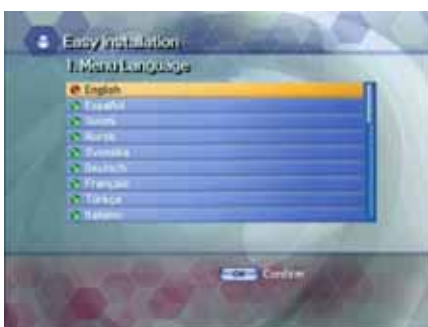

#### 2.2.1 Language

The first option in “**Easy Installation**” is to select the desired language of the Menu, Audio, or Subtitle.

Place the cursor on the sub menu by pressing the keys and press the **OK** button to change the language.

The Language of the Menu, Audio, or Subtitle will be changed to the selected language.



#### 2.2.2 Local Time/GMT

Select the time setting type.

Press the **LEFT/RIGHT** button to select either **Local Time** or **GMT** and then press the **DOWN** button to move to the time setting item.

##### When Local Time is selected.

You can set your local time according to your location.  
To set the local time, press the **NUMERIC** button.

##### When GMT is selected.

Press the **LEFT/RIGHT** button to select the current time zone from standard time and then press the **OK** button.

When you press the **LEFT/RIGHT** button, the time zone will move by 30 minutes.

## 2.2 Easy Installation



### 2.2.3 Channel Search

You can search the channels.

If you press the **OK** button, the Installation screen will appear

If you want to search the channel, you select between Satellite and Terrestrial. And then press the **OK** button to move to the channel search setting screen.



### 2.2.4 Satellite - Channel Search

Select the satellite you want using the **UP/DOWN** buttons on the satellite list.

#### ◆ To Edit or Add satellite list

- To edit or add satellite list on the list, press the **YELLOW** button to select edit or add mode. And press the **OK** button.
- Place the cursor on satellite field and press the **OK** button.
- The keypad will be displayed so that you can **Edit** or **Add** satellite name you want.
- Input degree you want using the **NUMERIC** buttons or the **LEFT/RIGHT** buttons. And press the **OK** button to save.



#### ◆ To Delete satellite list

- To delete satellite list on the list, press the **YELLOW** button to select delete mode. And press the **OK** button.

#### ◆ To Edit, Add, or Delete TP list

- When the **GREEN** button is pressed, it can be toggled Satellite list and TP list.
- Press the **YELLOW** button to edit, add or delete the TP list.
- Input Mode, Frequency, Symbol Rate, Polarity, and FEC, and press the **OK** button to save.

#### ◆ TP Search

Press the **RED** button on the TP list.

Pop up window will be displayed on the screen.



- **Frequency:** Input a proper Frequency using the **NUMERIC** buttons.
- **Symbol Rate:** Input a proper Symbol Rate using the **NUMERIC** buttons.
- **Polarity:** Use the **LEFT/RIGHT** buttons to select the Polarisation of the transponder. (Horizontal, Vertical)
- **FEC:** Use the **LEFT/RIGHT** buttons to select the FEC of the transponder.



- You can select the value of Auto, 1/2, 2/3, 3/4, 5/6, and 7/8.
- **Network:** You can select Yes or No. When you select "Yes", you can find more transponders using the home network.
- **Video PID/Audio PID/PCR PID:** You can set PID to search for services. Use the **LEFT/RIGHT** buttons or the **NUMERIC** buttons to input the value. Press the **OK** button to start Scanning.

## 2.2 Easy Installation



### ◆ C/KU Switch:

You can select C/KU band by selection of switch type. (None, DiSeqC Switch)

### ◆ Position (DiSeqC 1.2)

After selecting a satellite, please select position number. To change value, press the **OK** button. The position list will be displayed.

### ◆ LNB Freq.

Select the proper LNB frequency referring to your LNB using the **OK** and the **UP/DOWN** buttons.

### ◆ C-LNB Freq.

When selecting the C/KU Switch is selected as "None", the C-LNB Freq will be dimmed automatically.

Press the **OK** button, and then the C-LNB Freq. list will be displayed.

You can also input the freq. you want. After inputting freq.

Using the **NUMERIC** buttons, press the **OK** button.

(None, DiSeqC Switch)

### ◆ LNB Power

Select the LNB Power On or OFF.

### ◆ 22KHz

Depending on the user's antenna switch box or LNB. You can supply either 22KHz by setting "ON" or not by setting "OFF".

### ◆ Tone Burst

Depending on the user's antenna switch box. ("off", "SAT A" or "SAT B")

### ◆ DiSeqC - DiSeqC

You can select and use appropriate port for your DiSeqC switch box. Press the **OK** button to select DiSeqC List. (None, DiSeqC A, DiSeqC B, DiSeqC C, DiSeqC D, Motor, USALS)

### ◆ DiSeqC - DiSeqC 1.2 and USALS

Press the **BLUE** button to set Drive(Fine Drive or Normal Drive) to run the motor.

#### • Fine Drive/Normal Drive

To move the motor, press the **LEFT/RIGHT** button.

#### • Go to zero

To move the zero position, press the **OK** button.

#### • Store to location

To store the current position, press the **OK** button.

#### • East Limit

To set the east limit by current position, press the **OK** button.

#### • West Limit

To set the west limit by current position, press the **OK** button.

#### • Clear Limit

To clear the stored limit value, press the **OK** button.





## 2.2 Easy Installation



### ◆ Scan

- After selecting all that is necessary, press the **RED** button to scan the satellite list.  
Pop up window will be displayed.
- Select ON or OFF according to your **Network**.
- Select All or FTA **Search Type**.
- Select All, TV, or Radio **TV/Radio type**.
- Press the **OK** button and searching will start.

### Note

- After the Degree, Longitude and Latitude is entered accurately, the DiSEqC Motor will automatically move to the satellite's position.



### 2.2.5 Terrestrial - Channel Search

#### ◆ Manual Search

Manual search is more convenient to search a specific MUX. This menu searches also channels broadcasted over a specific MUX using its detected information.

- Press the **UP/DOWN** buttons to select the MUX No. you want to find, and then press **OK** button to add or remove from the search list.
- To start search, press the **GREEN** button.
- At the pop up window, select all channel or FTA channel search.
- Press the **BLUE** button to change the MUX priority. (Auto/High/Low).
- When searching is started, the name of channels searched will be displayed on the screen.
- When searching is finished, the "**Search finished**" message will be displayed on the center of the screen.
- Press the **OK** button to save the channel list and watch the channel searched.



### 2.2.6 USALS

Set Longitude and Latitude when you use USALS.

- Press the **UP/DOWN** buttons to select Longitude and Latitude.
- Press the **NUMERIC** buttons to set the angle of Longitude and Latitude.
- Press the **OK** button to set the direction of Longitude and Latitude.

# 3. Basic Operation

## 3.1 Basic Function Usage

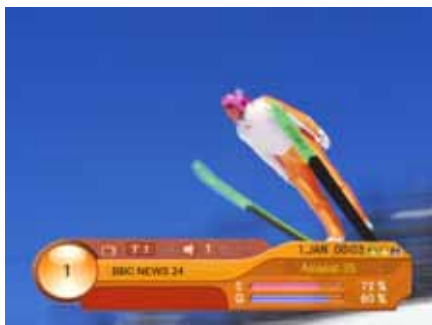

### 3.1.1 Program Information

After the television channels have been programmed, you will see the information box each time you change the channels.

- Every time you change channels you will receive program information for a few seconds. (In the “**Banner Time**” menu you can select how long this information will be shown.)
- You may change channel with the **UP/DOWN** button. You can get “**Channel Banner**” at the bottom of the screen.
- When you press the **COLOR** button, you can use the banner as a simple channel operation.



### 3.1.2 Now-Information Banner

- During “**Channel Banner**” is appearing, when you press the **INFO(BLUE)** button, you can get “**Now-Information Banner**”.
- Using “**Now-Information Banner**”, you can get a simple EPG of “**Now-Information**”.



### 3.1.3 Next-Information Banner

- During “**Channel Banner**” is appearing, when you press the **YELLOW** button, you can get “**Next-Information Banner**”.
- Using “**Next-Information Banner**”, you can get a simple EPG of “**Next-Information**”.

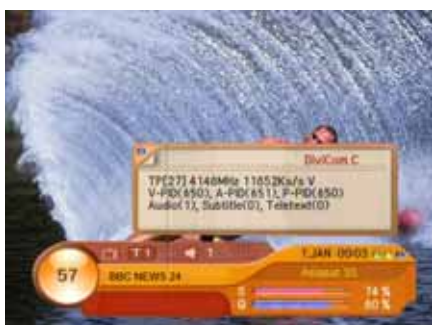

### 3.1.4 Channel-Information Banner

- During “**Channel Banner**” is appearing, when you press **GREEN** button, you can get “**Channel-Information Banner**”.
- Using “**Channel-Information Banner**”, you can get a detailed channel listing information.



### 3.1.5 Volume Control/Mute

- To control audio volume, press the Volume **UP/DOWN** buttons.
- Volume control bar will be appeared in bottom of the TV screen.
- To temporarily stop the volume, press the **MUTE** button. To cancel mute, press the **MUTE** button again or press the **Volume UP/DOWN** buttons.

## 3.1 Basic Function Usage



### 3.1.6 Subtitle

- Press the **SUB-T(Red)** button and the popup window will be displayed on the screen.
- Select the Off then subtitle function is off.
- Select the Subtitle language, and then you can see Subtitles.



### 3.1.7 Teletext

- If a broadcast supports teletext, you can watch teletext.
- If you press the **TEXT** button, teletext will appear on the screen.

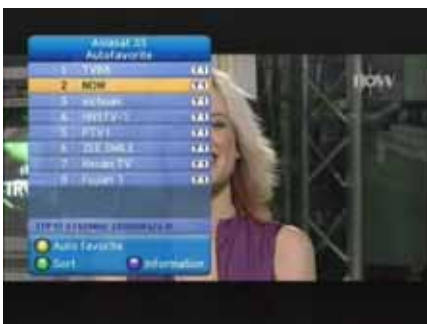

### 3.1.8 Simple Channel List

- When you press the **OK** button during receiving service stream, you can get “**Channel List**” view.
- Using the **UP/DOWN** button in “**Channel List**” view, you can choose another channel.
- After moving highlight on a channel, then press the **OK** button.
- To get the channel sort list, press the **SORT(Green)** button. Pop up window will be displayed on the screen.
- Select the sort list you want with the **UP/DOWN** buttons and then press the **OK** button to get it. There are seven ways of sorting : **Normal, Tuner, Satellite, CAS, Network, Genre, and Favorite.**
- Press the **INFO(Blue)** button. You can see the Signal of current channel on the Simple Channel List.

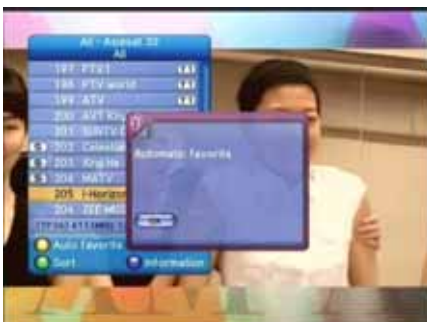

### 3.1.9 Auto Favorite

- You can edit auto favorite.
- Press the **YELLOW** button in Simple Channel List.



### 3.1.10 Soundtrack

- When you want to change the Audio Language of current channel, press the **A.LANG** button on the remote control. The on-screen menu is displayed on the left side of the screen.
- Use the **UP/DOWN** buttons to choose the audio you want.
- To cancel or exit, press the **A.LANG** button again.
- You can change a default audio language in the system setting menu mode.



## 3.1 Basic Function Usage



### 3.1.11 To change the audio output

- Press the **A.L/R** button on the remote control unit to change the output.
- Then on-screen menu is displayed on the top right side of the screen.
- Press the **A.L/R** button repeatedly to change the sound mode. (Mono, Left, Right, Stereo)



### 3.1.12 PIP

The PIP (Picture-in-Picture) function allows you to watch two screens at the same time. With the PIP function, you can move the PIP screen or freely adjust the screen size.

- If you press the **PIP** button while the channel is showing on the screen, the PIP will be shown at the top left of the screen.
- If you press the **PIP CH** button, the PIP Simple Channel List will appear on the screen.
- Press the **UP/DOWN** button on the PIP Simple Channel List screen to select a channel, and press the **OK** button.
- Press the **MODE** button and press the **UP/DOWN/LEFT/RIGHT** button to change the location of the PIP screen.
- Press the **MODE** button once again and press the the **UP/DOWN /LEFT/RIGHT** button to change the size of the PIP screen.
- If you press the **MODE** button once again, you can see the screen as a multi-media window type. The main screen will be displayed on the left, and the PIP screen on the right side of the screen, as a multi-media window type.
- Press the **SWAP** button to swap the main screen for the PIP screen, while the PIP screen is showing.



### 3.1.13 Recall List

Recall List is to show the previous channels (up to 10 channels).

- If you press the **RECALL** on the screen, the Recall List Pop-up window will appear.
- Press the **UP/DOWN** button to select the channel and then press the **OK** button. The changed channel will be shown with the channel banner.



### 3.1.14 DISPLAY Setting

This mode changes settings such as the TV Type, RF Channel, and RF Mode.

If you press the **DISPLAY** button, the **A/V Settings** screen of the System Setting menu will appear. Change the settings on the screen.



## 3.1 Basic Function Usage



### 3.1.15 TV/Radio Change

With this function, you can change the Radio listening mode while you are watching TV.

If you press the **TV/RADIO** button while you are watching TV, the radio listening screen will appear. If you press the **TV/RADIO** button again, the TV screen will reappear.



### 3.1.16 Multi Video

Multi Video allows you to watch several channels in one screen simultaneously. It can be used to watch one channel from among several channels.

- Press the **Multi Video** (  ) button while you are watching TV, the Multi Video pop-up window will appear.



### 3.1.17 Satellite and Terrestrial Change

With this function, you can change the Tuner while you are watching TV. Tuner change cannot be done while PIP is in use.

If you press the **TUNER** button while you are watching TV, the tuner change pop-up window will appear. Each time you press the **TUNER** button, the tuner will be changed.

## 4. Main Menu Guide

### 4.1 PVR - Record & Play



#### 4.1.1 Record

With this function, you can check file information while recording with the PVR. In addition, you can set the record-end time, and the power to go off after recording.

- Press the **UP/DOWN** button on the PVR menu to select Record and then press the **OK** button.
- When you press the **OK** button on the Record screen, the Edit screen will appear.
- Press the **UP/DOWN** button on the Edit screen to select the items for setting. These are record-end time, and power ON/OFF after recording.
- When you finish setting, press the **RED** button to save. The details of the setting will be displayed on the Record screen.



#### 4.1.2 General Recording

Press the **RECORD** button to record the current broadcast program. When the recording starts the Record Icon is displayed.

#### 4.1.3 Multi-Channel Recording

If you change channels while recording and press the **RECORD** button, recording starts.

You can record two channels simultaneously in the manner described above.



#### 4.1.4 Time Shift Recording

This function is for setting the **Time Shift**. If you set to ON, you can use the **Time Shift** function.

If the Time Shift is set while watching satellite broadcasting, press the **REW** button once to rewind the currently playing screen and the **PLAY/PAUSE** button to pause.

If you press the **PLAY/PAUSE** button, the screen will play back from the point where it is stopped.



#### 4.1.5 To stop Recording

- If you press the **STOP** button the currently recording channels are displayed on the pop-up window.
- Press the **UP/DOWN** buttons on the pop-up window to select the channel to be stopped and then press the **UP/DOWN** buttons again to select further channels.
- When you finish selecting channels to be stopped, press the **STOP** button. Recording of the selected channels stops.

## 4.1 PVR - Record & Play



### 4.1.6 Fast-Forward & Rewind

The Fast-Forward and Rewind functions enable the user to view the front, back or any desired part of the file.

- To view forward parts press the **FF** button and to view previous parts press the **REW** button on the remote control.
- The screen will move when the relevant symbols appear on the top right-hand side of the screen.
- To Rewind or Fast-Forward at a faster speed, press the relevant button again.
- Press the **PLAY** button at the desired place to PLAY at the recorded speed.



### 4.1.7 Slow-Motion

The Slow-Motion function can be used to PLAY at a slower speed.

- Pressing the **SLOW MOTION** button will play the screen at a slower speed.
- If the button is pressed again, the screen will play at an even slower speed.
- Press the **STOP** button to **PLAY** at the recorded speed.



### 4.1.8 Quick Replay/Forward

If you press and hold the **QUICK REPLAY/FORWARD** button, you can rewind or fast forward the screen with 4X-speed. If you release the button, the screen will play back.

### 4.1.9 Quick-Search

You can move to the desired location using the banner.

- If you press the **BLUE** button on the currently playing screen the channel banner will appear.
- If you press and hold the **LEFT/RIGHT** buttons while the channel banner is visible, the location icon moves along the progress bar.
- If you release the **LEFT/RIGHT** buttons at the desired point, playing starts at that point.



### 4.1.10 Book Mark

If you press the **Progress bar** button while playing AV file, Progress for **BOOKMARK** will appear.

- Press the **OK** button to specify or remove **BOOKMARK**.
- Use the **UP/DOWN** button to move between bookmarks.
- Use the **RED** button to select A-B repeat.  
If you press the **RED** button once, the start point will be set.  
If you press it again, the end point will be set.  
If you press it once more, set A-B repeat will be initialized.
- Press the **GREEN** button to decide whether to use A-B repeat.
- Use the **YELLOW** button to erase all bookmarks.

## 4.1 PVR - Record & Play



### 4.1.11 To File Playback

With this function, you can play recorded files.

- If you press the **MODE/FILE** button while watching TV, the File List screen will appear. The currently saved directory in the HDD will be displayed on the File List screen.
- Press the **UP/DOWN** button to select **AVDATA** and then press the **OK** button.
- Press the **UP/DOWN** button to select the desired file and then press the **OK** button. It starts playing.

### 4.1.12 File List

File List manages the files and directories in the HDD.

Press the **UP/DOWN** buttons on the PVR menu to select the File List and press the **OK** button. The recorded files and directories currently saved in the HDD will appear. Various basic directories such as AVDATA, MP3 and SOFTWARE will appear in the directory. The names of the basic directories cannot be changed.

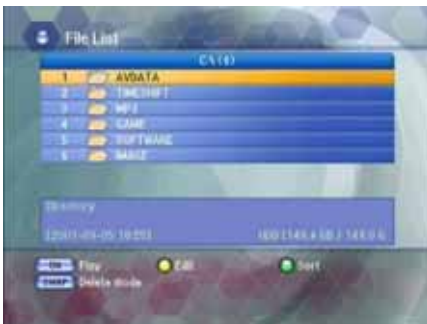

#### The basic directories are as follows :

- **AVDATA:** Directory that saves recorded files
- **MP3:** Directory that saves MP3 files
- **SOFTWARE:** Directory that saves software-related files
- **GAME:** This is the directory that the ROM file downloaded from the Internet site can be saved on. Select the saved ROM file and press the **OK** button to play the game.
- **IMAGE :** Directory that saves image files.



### 4.1.13 Play Mode

Press the **SWAP** button to change the **Play** mode.

#### ◆ Play

Press the **UP/DOWN** buttons on the directory menu to select the desired file or directory and then press the **OK** button. If the file is selected, the file will play. If the directory is selected, the selected directory file list will be displayed.

#### ◆ Group Play

- Move to the directory where the file for Group Play is located.
- Press the **UP/DOWN** buttons on the Directory screen to select the file to be added to the Group Play List and then press the **RED** button.
- The number will be displayed for the selected file. Select the file to be added to the Group Play List in the same manner as described above. If you press the **RED** button again, the added file will be canceled.
- When you finish the file selection for Group Play press the **BLUE** button. The Group Play List pop-up window will appear.
- If you press the **BLUE** button on the Group Play List pop-up window, it starts playing.





## 4.1 PVR - Record & Play

### Note

- If you press the **GREEN** button on the Group Play List pop-up window after selecting the file, the selected file will be deleted.
- If you press the **RED** button on the Group Play List pop-up window, all files will be deleted.

### ◆ Play List Edit

- If you press the **YELLOW** button on the File List screen, the File Edit pop-up window will appear.
- Press the **UP/DOWN** button to select the items to be edited and then press the **OK** button.



### The items you can edit are as follows :

- **New Directory:** To create a new directory in the current directory.
- **Rename:** To change file or directory names. Characters such as 0~9, a~z and A~Z can be used.
- **Delete:** To delete a file or directory.
- **Lock:** To set for entering a password when you access files and directories. They are then displayed as “hidden files” in Microsoft Windows, after the USB cable is connected.
- **Move:** You can change the position of the files. Using the **UP/DOWN** buttons, select the files you want to move and press the **OK** button.



### ◆ Play List Sort

- If you press the **GREEN** button on the File List screen, the File Sort pop-up window will appear.
- Press the **UP/DOWN** button to select the arrangement method and then press the **OK** button. The different methods are as follows:

### The basic directories are as follows :

- **File Name:** To arrange files in file name order.
- **Date:** To arrange files in date order.
- **File Type:** To arrange files in file type order.
- **Lock:** To arrange files according to whether locked or not.

### 4.1.14 Delete Mode

Press the **SWAP** button to change the **Delete** mode.

#### ◆ Select

Press the **OK** button on the File List screen. The Checking Mark will appear On all file of the file list

#### ◆ Select All

Press the **RED** button on the File List screen. The Checking Mark will appear On all file of the file list.

#### ◆ Delete

Press The **YELLOW** button on the File List Screen. You can delete All checked File.

#### ◆ Lock

Press The **GREEN** button on the File List Screen. You can lock All checked File.



## 4.1 PVR - Record & Play



### 4.1.15 Timer

With this function, you can set reserved recording functions including adding, changing and deleting reserved recordings. You can add a reserved recording.

- Press the **UP/DOWN** buttons on the PVR menu to select the Timer and then press the **OK** button.
- If you press the **BLUE** button on the Timer screen, the Add screen will appear.
- Press the **UP/DOWN** buttons on the Add screen to select the items for setting.

#### These are as follows :

- **Type:** To set the type of reserved recording. There are three kinds of reserved recording: PVR, DVR and Analog PVR.
- **Mode:** To set the interval for the reserved recording. You can choose to record once, every day or every week.
- **Date:** To set the date for the reserved recording.
- **Time:** To set the time the reserved recording starts.
- **End Time:** To set the time the reserved recording Ends. If End time is passed, the reserved recording will stop.
- **Channel:** Appears when you set the Type to PVR. Press the **OK** button to set the channel you want to record.
- **Power off:** If you select "Yes", the receiver turns to the Stand by mode automatically after the recording. If you select "No", the receiver doesn't turn to the Stand by mode.
- Press the **RED** button to save. The details of the setting will be displayed on the Timer screen.

#### Note

- To change the reserved recording, select reserved recording on the Timer screen and then press the **OK** button. When the Edit screen appears, change the reserved recording in the same way as you did with adding.
- To delete a reserved recording, select it on the Timer screen and then press the **RED** button.
- Please be aware that when you change the System's Local Time or edit a reserved channel, the Timer might also change
- If you skip a reserved channel, or Delete it, the reserved settings are canceled.

### 4.1.16 USB Connection

- Press the **UP/DOWN** buttons on the Utility screen to select USB Connection and then press the **OK** button.
- The 'USB connected' message pop-up window will appear. Press the **EXIT** button to disconnect USB.

## 4.1 PVR - Record & Play



### 4.1.17 Format HDD

- To format the HDD, press the **UP/DOWN** button on the PVR menu to select Format HDD and then press the **OK** button.
- When the format confirmation pop-up window appears, press the **OK** button.



### 4.1.18 HDD Information

You can see the HDD Information.  
(Size, Serial Number, Firmware Version, Model Name)

## 4.2 Edit Channel List



From these menus, you can create favorite lists, lock, skip, delete, or move channel.

- Select “**Edit Channel List**” in the main menu with the **LEFT/RIGHT** buttons and press the **OK** button.
- At the request window, Input PIN code. If you have not entered your own PIN code, then the PIN code 0000 applies, which was set at the factory.
- Press the **UP/DOWN** button in MODE to select the desired mode and then press the **OK** button.
- Among the all channel list, the selected channel can be moved to the right folder of **Favorite(Auto Favorite, 1~31)**, **Lock**, **Delete**, **Skip**, **Move**, **Genre**. Press the **OK** button to add from edit list at right folder.
- To remove the channel list from edit list at right folder, press the **OK** button. The edited list will be removed.
- To rename the channel, press the **YELLOW** button.
- Press the **BLUE** button to change the favorite name.
- To confirm the channel list, press the **MENU** button or the **EXIT** button. The request window will be displayed on the screen, Press the **OK** button to save or the **EXIT** button to exit this menu.

### Note

- Press the **GREEN** button to arrange the channels.  
When the Sort pop-up window appears, select the desired arrangement and then press the **OK** button.
- Press the **RED** button if you want to include all the channels in the channel list.



## 4.2 Edit Channel List



### 4.2.1 Favorite(Auto Favorite, 1~31)

- You can edit favorite TV and Radio list. This enables you to create the 31 favorite TV and Radio lists.
- Select the channel you want to edit on the favorite list and press the **OK** button.



### 4.2.2 Lock

- From here you can lock channels in any of the list in order to prevent e.g. your children from watching.
- Select the channel you want to lock and press the **OK** button.
- Repeat the procedure for each channel you want to lock. When you lock a channel in any list, the channel will be locked automatically in all other lists.



### 4.2.3 Delete

- You can delete the TV or Radio channel from the current list.
- Select the channel you want to delete and press the **OK** button.



### 4.2.4 Skip

- You can skip the TV or Radio channel from the current list.
- Select the channel you want to skip and press the **OK** button.
- To recover the skipped channel, press the **OK** button from edit list.

### 4.2.5 Move

- You can change the position of the channel you want on the TV/Radio/All channel lists.
- Select the channel you want to move to desired channel and press the **OK** button.
- And press the **BLUE** button to change the position of the channel you want.
- Using the **UP/DOWN** buttons, select the channel you want to move and press the **OK** button.
- The position of the channel will be moved.



### 4.2.6 Genre

- You can edit the TV and Radio list of the various genres. (Movie, News and Factual, Entertainment, Sport, Children, Factual, Education, Lifestyle, Drama, Music, Arts, Current Affairs, Special, Comedy, Documentary.)
- Select the channel you want to edit genre list and press the **OK** button.

## 4.3 Program Guide



The program guide provides information such as the program listings and ending times for all available programs. You can reserve a recording by pressing **RECORD** button.

Select "**Program Guide**" in the main menu with the **LEFT/RIGHT** buttons and press the **OK** button. In the viewing program, when you press the **EPG** button, you can get this view.

### Note

- The Program Guide information might not be supported by the service providers.



### 4.3.1 Grid EPG Program Guide

- Press **UP/DOWN** buttons to change channels. You can find out channel information at top screen.
- Press **OK** button, you can change channel as well.
- Press **LEFT/RIGHT** buttons to check the existing EPG info as per its time.
- In case detailed info content is too long to check, you can check its information as a long lists form, and resize its lists by pressing **BLUE** button.
- Press **GREEN** button in order to sort channel lists.



### 4.3.2 EPG(Electronic Program Guide) Information

- To view the Program Guide, press the **GUIDE** button on the remote control unit. The EPG information will be displayed on the bottom of the screen.
- Each press of the **UP/DOWN** buttons will change the displayed EPG information by one hour.
- Each press of the **LEFT/RIGHT** buttons will change the displayed EPG information by one day.
- If there is available EPG information, it will be displayed on the EPG information bar.
- Press the **GUIDE** button again, and the Program Guide menu will be displayed.

You can reserve a recording by pressing **RECORD** button.



## 4.4 System Setting



You will be asked to enter your PIN code before you can enter this menu. The PIN code preset to 0000 from the factory.

If you want to customize the system to suit you better, you can specify some settings from the submenus in the “**System Setting**” menu.

- Select “**System Setting**” in the main menu with the **LEFT/RIGHT** buttons and press the **OK** button.
- If you move the focus on the main menu, the contents of the selected menu will be shown.

### 4.4.1 Language

- Press the **UP/DOWN** buttons on the Setup list to select Language and press the **OK** button.
- Press the **UP/DOWN** buttons to select Menu Language, Audio Language or Subtitle Language and then press the **RIGHT** button to move to the right pop-up menu.

#### ◆ Menu Language

Here you may select in which language the menus will be shown. Use the **UP/DOWN** buttons to move to the language you want and then press the **OK** button.

#### ◆ First Audio Language / Second Audio Language

In this menu, you can change default language for audio when changing services.

Use the **UP/DOWN** buttons to move to language you want and then press the **OK** button.

#### Note

- Select the audio language between the first and second audio language.
- If the first audio language is not selected, then the second audio language is selected by default.  
(If both the first and second audio language are not available, the audio language is set to the first audio language the selected channel supports for.)

#### ◆ First Subtitle Language / Second Subtitle Language

In this menu, you can change default language for subtitle when changing services.

Use the **UP/DOWN** buttons to move to language you want and then press the **OK** button.

#### Note

- If you cancel the subtitle function, select the off. (Option)
- Select the subtitle language between the first and second subtitle language.
- If the first subtitle language is not selected, then the second subtitle language is selected by default.  
(If both the first and second subtitle language are not available, the subtitle language is set to the first subtitle language the selected channel supports for.)





## 4.4 System Setting



### 4.4.2 Time

- Press the **UP/DOWN** button on the Setup list to select Time and then press the **OK** button.
- Press the **UP/DOWN** button to select either **Banner Time**, **Time**, or **Day Light Saving** and then press the **RIGHT** button to move to the right pop-up menu.

#### ◆ Banner Time

When you switch channels, an information banner will be shown for a few seconds.

You can select for how long the banner will be shown.

- Select the banner time you want and then press the **OK** button.
- Each selectable time items has meaning of the interval time during a channel banner stays on changed channel screens.  
The time ranges 1, 3, 6, 9, 12, and 15 seconds.



#### ◆ Time

Select the time setting type.

Press the **LEFT/RIGHT** buttons to select either Local Time or GMT and then press the **DOWN** button to move to the time setting item.



#### Local Time

You can set your local time according to your location.

- To set year, month and date, press the **UP/DOWN** buttons. The Calendar pop up window will be displayed. Select year using the **RED** and **GREEN** buttons. Select month using the **YELLOW** and **BLUE** buttons. Select date using the **UP/DOWN** or the **LEFT/RIGHT** buttons.
- Adjust hour and minute with the **UP/DOWN** buttons and move the field with the **LEFT/RIGHT** buttons.
- When the **OK** button is pressed, the selected time applies.



#### GMT

Press the **UP/DOWN** buttons to select the current time zone from standard time and then press the **OK** button. When you press the **UP/DOWN** buttons, the time zone will move by 30 minutes.

#### ◆ Day Light Saving

If you want to turn the Day Light Saving on, press the **UP/DOWN** button to select ON and then press the **OK** button.



## 4.4 System Setting



### 4.4.3 Lock Control

- Press the **UP/DOWN** button on the Set list to select Lock Control and then press the **OK** button.
- Press the **UP/DOWN** buttons to select either Menu Lock, Parental Lock, Receiver Lock or Change PIN Code and then press the **RIGHT** button to move to the right pop-up menu.

#### ◆ Menu Lock

If the Menu Lock is already set, the PIN code is needed to set the Edit Channel List and System Setting.

If you want to set the Menu Lock, press the **UP/DOWN** buttons to select Locked and then press the **OK** button.



#### ◆ Parental Lock

When you change “Parental Lock” to “On” or “Off”, service channel can get or not from that set values. If you select “On”, you may need PIN code every time you select the lock channel program as you set in the channel control.

If you select “Off”, you can see all channels without PIN code.

#### ◆ Receiver Lock

If you select “On”, you will have to enter the PIN code every time you start the receiver from standby.

#### ◆ Change PIN Code

From here you can change the PIN code from the standard 0000. **DO NOT FORGET IT!** Without it, you are not able to access to any of the functions where the code is required.

You can change password for Parental Lock and Receiver Lock simultaneously.



- Input the current PIN code using the **NUMERIC** buttons on the remote control.
- In the highlighted new PIN code, input a new PIN code.
- To verify the new PIN code, re-enter a new PIN code in the highlighted confirm PIN code. If the PIN code is correct, the message “**Success**” will be displayed on the display window.

#### Note

- If you forget the PIN code, press the RGYB(Color) button in sequence. (i.e. Red → Green → Yellow → Blue button) The PIN code will be changed to 0000.

#### ◆ Auto Power

- If the Auto Power is set to On and power is off, the Set turns on automatically and turns into the channel mode which you were watching before power breakdown.
- If the Auto Power is set to Off and power is off, the Set turns into the standby mode.



## 4.4 System Setting



### 4.4.4 A/V Setting

- Press the **UP/DOWN** buttons on the Setup list to select Display and press the **OK** button.
- Press the **UP/DOWN** button to select either Screen Type, Menu Transparency, SCART Output, SPDIF Output, RF Channel, RF Mode or TV Type and then press the **RIGHT** button to move to the right pop-up menu.

#### ◆ TV

If you have a TV set with 4:3 picture format, select 4:3 TV and if you have a TV set With 16:9 picture format, select 16:9 TV.

#### ◆ Screen Type

If you have a TV set with the 4:3 picture format and the transmission is in 16:9, you can select **Full**, **4:3 Letterbox** and **Cinema**.

Seleccione el ratio de aspecto de TV, que está conectado al receptor y luego presione el boton **OK**.



#### ◆ A/V Output

If your TV input supports SCART-RGB control, select SCART-RGB. Otherwise select SCART-CVBS. If your TV input supports S-VHS, select S-VHS.

#### ◆ Scart Screen Type

Select Your Scart Screen Type.

You can select from 4:3 and 16:9 and then press the **OK** button.



#### ◆ S/PDIF Output

You can hear digital audio of the Dolby 5.1 channel using S/PDIF Output.

- If selecting Off, the digital audio will not be output.
- When selecting PCM, the unzipped digital audio is output through S/PDIF.
- When selecting Dolby Digital, if the current channel is a Dolby audio channel, the zipped Dolby stream is output through S/PDIF.



#### ◆ TV Type

Select your TV Type. You can choose from Multi, NTSC, SECAM or PAL.

Press the **UP/DOWN** button to select from Multi, NTSC, SECAM or PAL and then press the **OK** button.



#### ◆ RF Channel

Select this alternative if you have to change the RF channel.

Select an UHF Channel you want with the **UP/DOWN** buttons.

The RF Channel ranges from 21 to 69.

## 4.4 System Setting



### ◆ RF Mode

You can select the RF Mode. If you get picture but no sound, the RF Mode selecting might be wrong.

Select an RF Mode and then press the **OK** button.

### Note

- PAL BG, PAL I, PAL DK, SECAM L, NTSC M

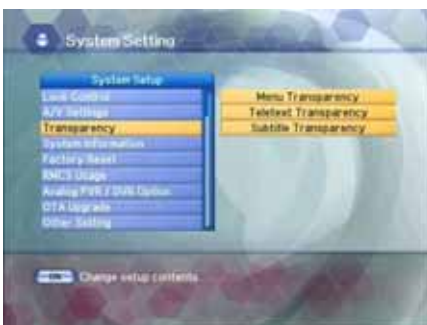

### 4.4.5 Menu Transparency

From 20% to 100% will give the variable transparency on Video and OSD screen.

To set menu transparency, press the **UP/DOWN** buttons.

Press the **OK** button and then press the **UP/DOWN** buttons to

select the Menu Transparency, Teletext Transparency, or Subtitle Transparency. The transparency will be applied on the screen.

### 4.4.6 System Information

Displays the system information: MODEL name, Last Update, S/W, H/W, Loader version, C.A

Press the **UP/DOWN** button on the Setup list to select System Information and then press the **OK** button.



### 4.4.7 Factory Reset

Press the **UP/DOWN** button on the Setup list to select Factory Reset. Use this option only if you have to start the complete installation procedure from scratch. If you continue from here, all your previous settings and all channels will be cleared! The default data will be loaded.

If you press the **OK** button, it asks for your confirmation.

If you want to reset, press the **OK** button, or press the **EXIT** button to exit this menu.



## 4.4 System Setting



### 4.4.8 OTA Upgrade

#### ◆ To set up OTA Upgrade

It is possible to set up OTA upgrade manually. Please check if there is new software as pressing **OK** button after entering **Frequency**, **Symbol Rate**, **Const..** Updated software will be downloaded.



### 4.4.9 Other Setting

#### ◆ Simple Channel List Hide

If you select "ON" in Simple Channel List Hide function, Simple channel list will be disappeared when you change the channel.

#### ◆ 5V Output

5 volt control for Active Antenna.





## 4.5 Utility (option)



Select “**Utility**” in the main menu with the **LEFT/RIGHT** buttons and press the **OK** button.



### 4.5.1 Calendar

Select “**Calendar**” in the Utility menu with the **UP/DOWN** buttons and press the **OK** button, you can see the Calendar.

### 4.5.2 Game

Press the **OK** button to move to the GAME folder of the File List. Select the GAME file on the HDD to play the game.



### 4.5.3 Demonstration

Select “**Demonstration**” in the Utility menu with the **UP/DOWN** buttons and press the **OK** button, you can see the Automatic Operation Function.

Press the **EXIT** button to quit the Automatic Operation Function completely.

### 4.5.4 Zoom

Select “**Zoom**” in the Utility menu with the **UP/DOWN** buttons and press the **OK** button, the white frame will appear.

- Select the size and position of video you want to expand with the **RED/GREEN**, **LEFT/ RIGHT** buttons and press the **OK** button. You can see the expanded video.
- Press the **YELLOW** button in the video only, you can then see the white frame.
- Press **EXIT** button in the video only, you can see the white frame.
- Press **EXIT** button to quit the expanded video completely.
- **RED** : Expand the size
- **GREEN** : Reduce the size



### 4.5.5 Set to Set

Select “**Set to Set**” in the Utility menu with the **UP/DOWN** buttons and press the **OK** button, upgrade Modules will appear.

- Connect the serial port Set To Set.
- You can receive the Application and Channels through the Set To Set function.



## 4.6 Common Interface



The menus are provided by the CA module and its smart card. Your receiver is equipped with two slots of Common Interface (CI), accepting both Type 1 and Type 2 PCMCIA. Plug in the appropriate CI module together with a valid smart card. You will then have access to the respective scrambled and Pay-Per-View services.

Insert the smart card into the CI module, and the CI module into the slot behind the flap on the front panel.

The CI and smart card modules determine the programs that can be de-scrambled.

The receiver supports two CI slots so you can plug in two different modules, automatically provide access to both services. Each smart card contains your subscription details. You can view your entitlement via the COMMON INTERFACE menu by using the MENU button as below.

- Press the **MENU** button and select Common Interface then Slot1 and Slot2 will be shown up on the screen and the menu will be appeared. Select the item and then you will see information for card. Press **EXIT** button if you wish to exit from this menu.
- If you inserted the smart card with CAM into the receiver, and switch on the receiver. Then you will see "CAM Initializing icon" on the top screen.
- If you do not insert the smart card, you will see the message "Insert the valid smart card". If you insert the smart card into the CI module then you can watch your selected channel.

## 5. Troubleshooting

<i>Problem</i>	<i>Solution</i>
No display LED on the front panel. No power supply	Power cord plug in correctly.
No Picture	Ensure that the STB is switched on. Check connection and correct. Check channel and video output and correct
Poor picture quality	Check the signal level, if this is low then try adjusting the alignment of your dish.
No Sound	Check the volume level of the TV and STB. Check the mute status of the TV and STB. Check the connection of audio cord.
Remote Control does not operate	Point remote control directly towards the receiver. Check and replace batteries. Check that nothing blocks the front panel.
Service is not running or scrambled	Check the whether the Common Interface module and smart card is correctly inserted. Check that the smart card is appropriate for the selected service.
You have forgotten your secret PIN code	Refer to Change PIN code of this owner's manual.

## 6. Technical Specifications

Tuner		
Satellite	Demodulation FEC Modes Rate Input Connector Frequency Range Symbol Rate	QPSK 1/2, 2/3, 3/4, 5/6, 7/8 F type female (75 Ohm) 950MHz ~ 2150MHz 2 ~ 45 Mbaud
Terrestrial	Demodulation Guard Interval Modes FEC Modes Rate Input Connector Frequency Channel Bandwidth	COFDM 2K/8K-Carrier 1/32, 1/16, 1/8, 1/4 1/2, 2/3, 3/4, 5/6, 7/8 IEC 169-2, Female UHF : 470 ~ 860 MHz, S-Band, VHF : 174 ~ 230MHz 7MHz, 8MHz
RF Modulator		
PLL type TV Standard RF Connector Frequency Range	CH 21-69 for the modulation PAL B/G, I, SECAM L, NTSC M selectable 75 Ohms, 169-2, Male/Female UHF: 470 ~ 860MHz	
MPEG TS A/V Decoder		
Video Resolution Input Bit Rate Transport Stream Audio Decoding Audio Mode	720 x 576 Max. 90 Mbit/s MPEG-2 ISO/IEC 13818-1 MPEG/Musicam Layer 1 & 2 Single / Dual Channel	
A/V & Data Input/Output		
Video Audio RS-232C USB	RCA/Cinch, Video Output(CVBS)/SCART(CVBS, RGB) S-VIDEO OUT RCA/Cinch Volume & Mute Control (Resolution: 20 bits DAC, Max 2Vrms) S/PDIF of Dolby Digital Bitstream Out Transfer rate 115Kbps, 9 PIN D-Sub Type 2.0 Device	
System Resources		
Flash Memory SDRAM Main CPU MPEG Chip	4 Mbytes 64 Mbytes μPD61130	
Power Supply		
Input Voltage Power Consumption Protection Type	AC 90-250V, 50/60Hz 45W Separate Internal Fuse SMPS	
Physical Specification		
Size(W x H x D) Net Weight Operating Temperature Storage Temperature	340 x 60 x 250 3kg 0°C ~ 50°C -20°C ~ -60°C	
Option Function		
Common Interface PVR SW Upload	2 DVB -CI Slots HDD 160 GB RS232C (Optional Via OTA)	



## Free Manuals Download Website

<http://myh66.com>

<http://usermanuals.us>

<http://www.somanuals.com>

<http://www.4manuals.cc>

<http://www.manual-lib.com>

<http://www.404manual.com>

<http://www.luxmanual.com>

<http://aubethermostatmanual.com>

Golf course search by state

<http://golfingnear.com>

Email search by domain

<http://emailbydomain.com>

Auto manuals search

<http://auto.somanuals.com>

TV manuals search

<http://tv.somanuals.com>