

# TRICITY BENDIX

*OPERATING & INSTALLATION  
INSTRUCTIONS*

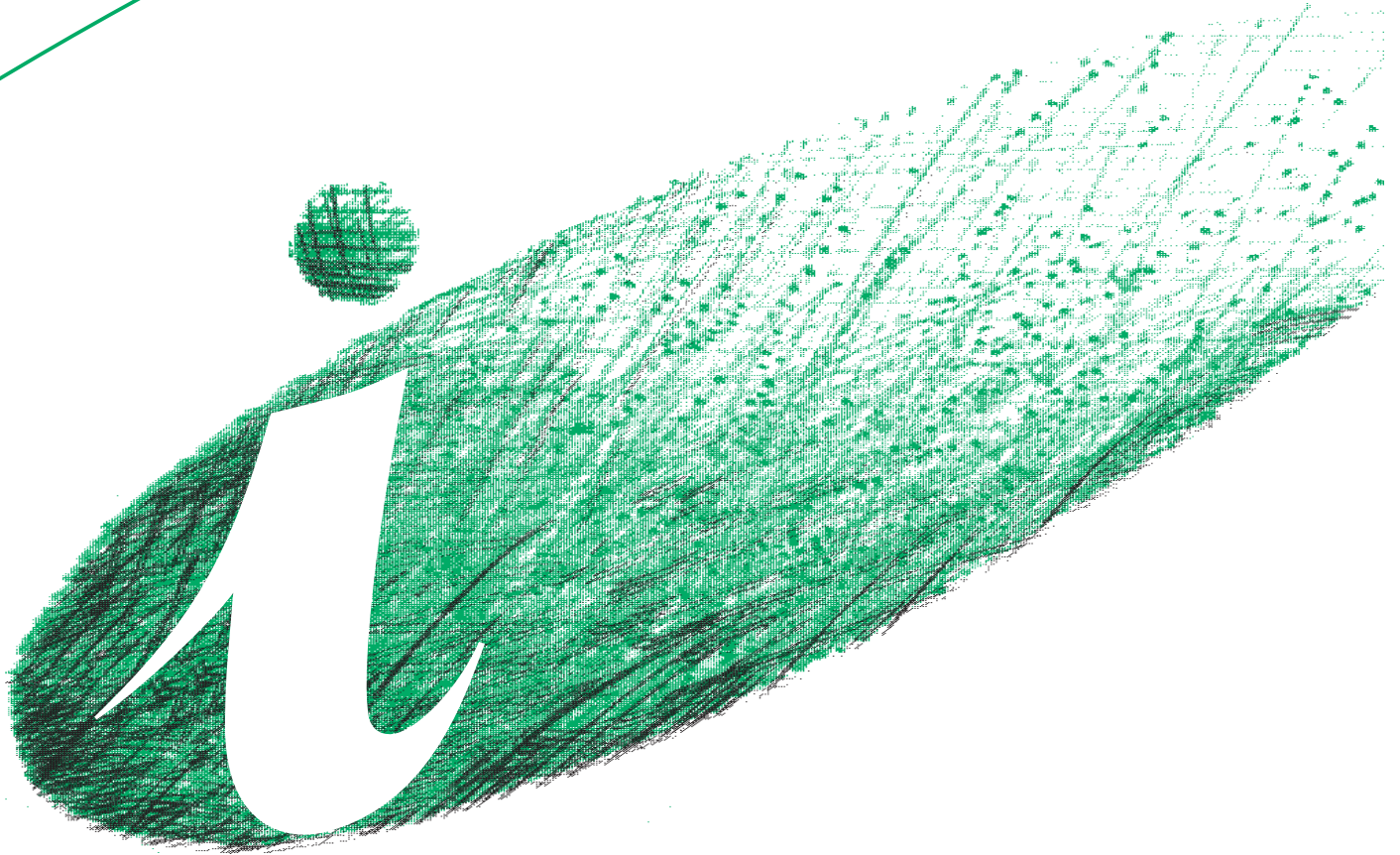

TUMBLE DRYER

**TM 220 W**

125993160

# Contents

<b>Important Safety Information</b>	<b>3</b>	<b>Service &amp; Spare Parts</b>	<b>7</b>
<b>Use</b>	<b>4</b>	<b>Guarantee Conditions</b>	<b>8</b>
Control panel	4	<b>Installation</b>	<b>9</b>
Use of controls	4	Positioning	9
Drying Times	5	Levelling	10
Drying	6	Door reversal	10
Useful hints	6	Electrical connections	11
<b>Maintenance and Cleaning</b>	<b>7</b>		
External cleaning	7		
Cleaning the door	7		
Cleaning the filter	7		
<b>Something not working?</b>	<b>7</b>		

## Technical Specifications

DIMENSIONS	Height	85 cm (33.5")	
	Width	60 cm (23.6")	
	Depth	57 cm (22.4")	
ELECTRICAL CONNECTION	Voltage	230 - 240 V/50 Hz	
	Max. power absorbed	2650 W (13A)	
DRYING CAPACITY	Cotton, linen	5 kg (11 lb)	
	Synthetics	2.5 kg (5 lb)	
CONSUMPTIONS	Cotton, linen	3.3 kWh	(5 kg store dry)
	Cotton, linen	2.7 kWh	(5 kg iron dry)
	Synthetics	1.1 kWh	(2,5 kg store dry)



This appliance complies with the following E.E.C. Directives:  
- 73/23 EEC of 19.2.73 (Low Voltage Directive) and subsequent modifications;  
- 89/336 EEC of 3.5.89 (Electromagnetic Compatibility Directive) and subsequent modifications.

### Stacking kit (optional accessory)

It should be possible to stack your new dryer on top of a front loading washing machine with a worktop depth of between 48 and 60 cm.

The instructions are supplied with the kit.

Please contact your Local Service Force Centre for further advice.



# Important Safety Information

**It is most important that this instruction book should be retained with the appliance for future reference. Should the appliance be sold or transferred to another owner, or should you move house and leave the appliance, always ensure that the book is supplied with the appliance in order that the new owner can get to know the functioning of the appliance and the relevant warnings.**

**These warnings have been provided in the interest of safety. You MUST read them carefully before installing or using the appliance.**

## Installation

- Any electrical work required to install this appliance should be carried out by a qualified electrician or competent person.
- Make sure that the appliance does not stand on its electrical supply cable.
- If the machine is situated on a carpeted floor, please adjust the feet in order to allow air to circulate freely.
- This tumble dryer is designed to be vented through to the open air. It should have its own ventilation system which should not be joined with any other ventilation system connected to any other appliance.

## Use

- Always unplug the appliance after use.
- Clothes which are dripping wet should not be placed in the dryer.
- Always load well spun laundry. The higher the spin speed, the lower the electricity consumption and the shorter the drying times.
- Never tumble dry items that have been in contact with chemicals such as dry cleaning fluid. These are of a volatile nature and could cause an explosion.
- As some bulky items such as duvets and eiderdowns should be dried in large commercial machines because of their bulk, check with the manufacturer of the item if it is suitable for drying in a domestic machine, even if the dry weight of the item is within the limit advised.
- Always check that no cigarette lighters have been left in pockets.

- Leave the porthole door slightly ajar when not in use to preserve the door seal.
- The fluff filter must be cleaned after every use.
- Do not operate the appliance with a damaged filter as this may cause a fire.
- Do not overload the appliance.
- Do not allow fluff to accumulate around the dryer.

## Service / Repair

- Under no circumstances should you attempt to repair the machine yourself. Repairs carried out by inexperienced persons may cause injury or serious malfunctioning. Refer to your local Tricity Bendix Service Centre. Always insist on genuine Tricity Bendix spare parts.

## General safety

- It is dangerous to modify or try to modify the specifications of this appliance in any way.
- This appliance is designed to be used by adults. Children should not be allowed to touch the controls or play with the product.
- Pets and small children may climb into tumble dryers. Check your appliance each time before use.

## Environment Protection

- The materials used on this appliance marked with the symbol  are recyclable. This means that they can be recycled by disposing of them properly in appropriate collection containers.
- If you take your appliance to a refuse disposal site, cut off the power cable flush with the appliance to avoid the danger of the appliance being re-used, and disable the door catch to prevent children from becoming trapped inside.

# Use

## Control panel

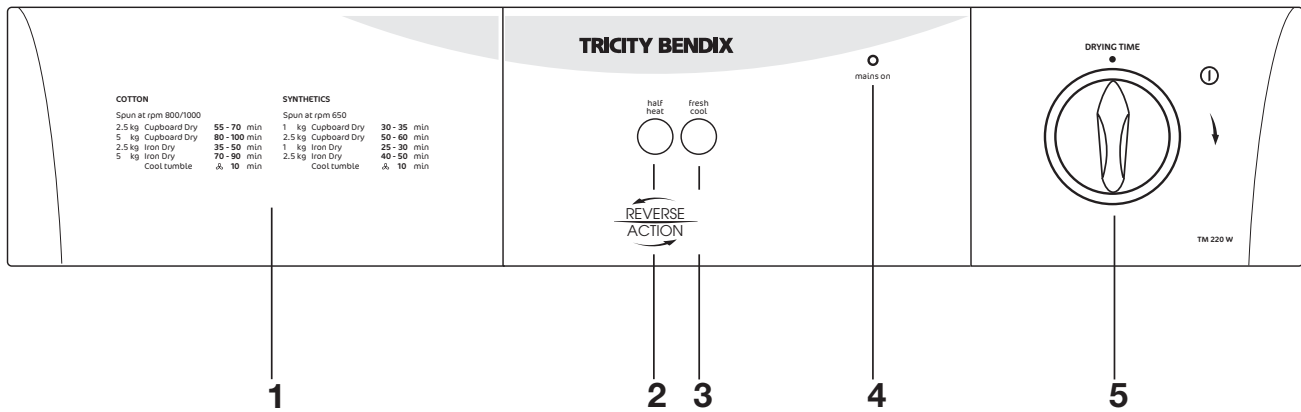

### 1 Programme Chart

This will help you to select the correct time for drying.

### 2 Half Heat Button

Press this button to reduce the temperature when drying particularly delicate cotton or linen items.

In this case you should select a longer drying time.

On the programmes for synthetics the temperature is automatically reduced.

Therefore it is not necessary to depress this button.

### 3 Fresh & Cool Button

By depressing this button the heat is cut off. This is particularly useful to freshen the laundry (e.g. to remove a persistent odour of moth-balls).

### 4 Mains-On Light

This lights up when the machine starts operating and goes out at the end of the programme.

### 5 Drying Time Selector Dial

The selector dial incorporates two drying cycles, one of up to 150 minutes at a high temperature (red section) for cotton and linen, and one of up to 100 minutes at a low temperature (grey section) for synthetic fabrics.

To set the machine to the selected time, turn the dial **clockwise** until the time you want coincides exactly with the pointer.

**NEVER** attempt to turn the dial in an anticlockwise direction.

When selecting the drying time, you should remember that it includes a 10 minute cooling phase (position  on the dial).

This phase should not be shortened, stopped or avoided, as this could cause skin burns or damages to the laundry.



### Additional drying

If at the end of the programme the laundry is still too damp, set the dial for a further period of drying (remembering to take into account the cooling period).

# Drying times

## Cotton and Linen

Selector dial: up to 150 minutes (red section)



Degree of drying required and labels on articles	Degree of spin given rpm	Quantity (1) kg	Drying times mins
Cupboard dry  (*)	800 - 1000	5	80 - 100
		2.5	55 - 70
	1200	5	75 - 90
		2.5	50 - 60
Iron dry 	800 - 1000	5	70 - 90
		2.5	35 - 50
	1200	5	65 - 80
		2.5	30 - 40

 high temperature

(\*) This programme is the reference programme for the Energy label according to the article 2, paragraph 1 of the EEC Directive 92/75.

## Synthetics

Selector dial: up to 100 minutes (grey section)

Degree of drying required and labels on articles	Degree of spin given rpm	Quantity (1) kg	Drying times mins
Cupboard dry 	650	2.5	50 - 60
		1	30 - 35
		0.5	25 - 30
Iron dry 	650	2.5	40 - 50
		1	25 - 30
		0.5	20 - 25

 reduced temperature

(1) Never overfill the drum (do not load large quilts, for example).

The laundry must be suitably spun in your washing machine before being placed in the tumble dryer (500rpm minimum). Drying times vary according to:

- The type of laundry
- The size of the load
- The degree of spinning prior to drying

Drying times are given as a guide only. Experience will soon enable you to estimate the drying time needed for your usual laundry loads.

Do not start by selecting a long drying time. It is better to determine the required degree of dryness by gradually increasing the drying time.

For a mixed load (cotton and synthetics, for example) select the time for the most delicate fibres and increase it by 10 mins.

# Drying

## 1. Load the laundry

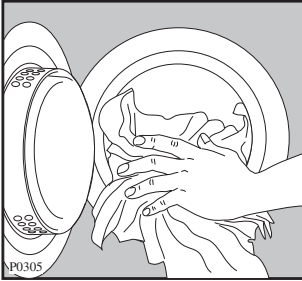

Open the door by pulling it outward.

Load the items one at a time, shaking them out loosely and close the door.

Please check the laundry does not get caught between the door and filter.

## 2. Select the required option

Depress Half Heat or Fresh & Cool, if desired.

## 3. Select time

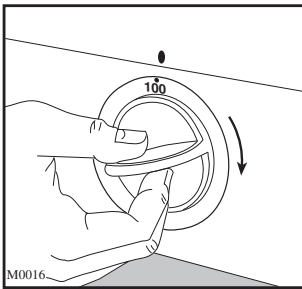

Turn the selector dial clockwise to the required minute setting (in the high or low temperature range, according to the fabric): the mains-on light illuminates and the machine starts operating.

## 4. When drying is completed

The machine stops automatically, the mains-on light goes out.

If the laundry is still too damp, select a further brief drying time, bearing in mind that during the last 10 minutes the dryer carries out the cooling and anti-crease treatment phase.

When the programme has finished you are advised to unplug the appliance.

**Clean the filter after every drying programme. A clean filter ensures correct functioning of the appliance.**

## Useful hints

- Try to load to the maximum capacity of the machine as small loads are uneconomical. For information, here is a list of the average weights of some common laundry items.

Sheet	700 - 1000 g
Tablecloth	400 - 500 g
Kitchen towel	70 - 120 g
Table napkin	50 - 100 g
Towelling hand towel	150 - 250 g
Bathrobe	1000 - 1500 g
Man's shirt	200 - 300 g
Pillowcase	100 - 200 g
Man's pyjamas	400 - 500 g
Ladies' nightdress	200 - 250 g

- Never tumble dry the following:  
Particularly delicate items such as net curtains, woollen, silk, fabrics with metal trim, nylon tights, bulky materials such as anoraks, blankets, eiderdowns, sleeping bags, feather quilts and any items containing rubber foam or materials similar to rubber foam.

- Always follow the instructions on garment labels.

- may be tumble dried
- tumble dry normal (high temperature)
- tumble dry delicate (low temperature)
- do not tumble dry

- Close pillowcases and covers with fasteners to prevent small laundry items getting tangled inside them. Close press studs, zips and hooks and tie belts and apron strings.
- Sort laundry according to type and degree of drying required.
- Do not over-dry laundry, this avoids creasing and saves energy.
- Avoid drying dark clothes with light coloured fluffy items such as towels as they could attract the fluff.
- Remove the laundry when the dryer has finished drying.
- To avoid a static charge when drying is completed, use either a fabric softener when you are washing the laundry or a fabric conditioner specifically for tumble dryers.

## Laundry Shrinkage

Certain fabrics such as woollens and silks are generally not suitable for tumble drying. Due to the structure of some woollen garments which are recommended for tumble drying, shrinking could still occur, but once the garment is worn again, it should regain its shape.

## Starched Laundry

Starched laundry can also be dried in the tumble dryer. Make sure that the time selected is for iron dry. After completion of the programme wipe out the drum with a damp cloth and dry to remove any traces of starch.



# Maintenance and Cleaning

## Important

You must **disconnect** the appliance from the electricity supply, before you can carry out any cleaning or maintenance work.

## External cleaning

Use only soap and water and then dry thoroughly.

From time to time, apply a little wax furniture cream with a soft cloth.

**Important:** do not use methylated spirit, diluents or similar products.

## Cleaning the door

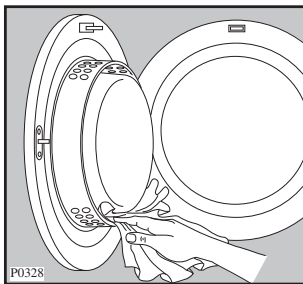

Clean periodically the interior part of the door to remove any fluff. Accurate cleaning ensures correct drying.

## Cleaning the filter

Your dryer will only function well if the filter is clean.

The filter collects all the «fluff» which accumulates during drying and it must therefore be cleaned at the end of each programme with a damp cloth.

The filter cannot be removed.

It is perfectly normal for fluff to accumulate in the filter during drying. In fact, even fabrics dried in the open air lose their fibres, but we do not notice it.

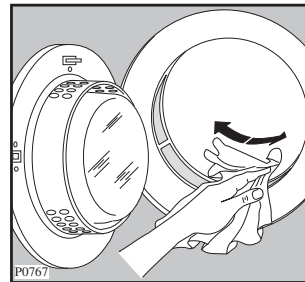

# Something Not Working

**Before contacting your local Tricity Bendix Service Centre, please make the following checks:**

## The dryer does not start up

- The door is open
- The plug is not fitted into the wall socket
- There is no electricity supply from the wall socket
- The time selector dial is not set correctly

## The dryer does not dry properly

- The filter is clogged
- Insufficient drying time
- Excessive laundry load
- The dryer is not correctly installed

## Service & Spare Parts

In the event of your appliance requiring service, or if you wish to purchase spare parts, please contact your local Tricity Bendix Service Force Centre by telephoning:

**0870 5 929929**

Your telephone call will be automatically routed to the Service Force Centre covering your post code area.

For the address of your local Service Force Centre and further information about Service Force, please visit the website at [www.serviceforce.co.uk](http://www.serviceforce.co.uk).

Before calling out an engineer, please ensure you have read the details under the heading “Something Not Working”.

When you contact the Service Force Centre you will need to give the following details:

1. Your name, address and post code
2. Your telephone number
3. Clear and concise details of fault
4. The model and serial number of the appliance (found on the rating plate - see picture).
5. The purchase date

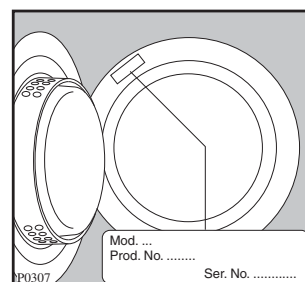

## Customer Care

For general enquiries concerning your Tricity Bendix appliance or for further information on Tricity Bendix products, please contact our Customer Care Department by letter or telephone as follows:

Customer Care Department  
Tricity Bendix  
55-77 High Street  
Slough  
Berkshire  
SL1 1DZ  
Tel 08705 950 950\*

\* calls to this number may be recorded for training purposes.

# Guarantee Conditions

### Standard guarantee conditions

We, Tricity Bendix, undertake that if, within 12 months of the date of the purchase, this TRICITY BENDIX appliance or any part thereof is proved to be defective by reason only of faulty workmanship or materials, we will, at our option, repair or replace the same FREE OF ANY CHARGE for labour, materials or carriage on condition that:

- The appliance has been correctly installed and used only on the electricity supply stated on the rating plate.
- The appliance has been used for normal domestic purposes only, and in accordance with the manufacturer's instructions.
- The appliance has not been serviced, maintained, repaired, taken apart or tampered with, by any person not authorised by us.

All service work under this guarantee must be undertaken by a Tricity Bendix Service Force Centre.

Any appliance or defective part replaced shall become the Company's property.

This guarantee is in addition to your statutory and other legal rights.

Home visits are made between **8.30am** and **5.30pm** Monday to Friday. Visits may be available outside these hours in which case a **premium** will be charged.

## Exclusions

### This guarantee does not cover:

- Damage or calls resulting from transportation, improper use or neglect, the replacement of any light bulbs or removable parts of glass or plastic.
- Costs incurred for calls to put right an appliance which is improperly installed or calls to appliances outside the United Kingdom.
- Appliances found to be in use within a commercial environment, plus those which are subject to rental agreements.
- Products of Tricity Bendix manufacture which are NOT marketed by Tricity Bendix.

## European guarantee

If you should move to another country within Europe then your guarantee moves with you to your new home subject to the following qualifications:

- The guarantee starts from the date you first purchased your product.
- The guarantee is for the same period and to the same extent for labour and parts as exists in the new country of use for this brand or range of products.
- The guarantee relates to you and cannot be transferred to another user.
- Your new home is within the European Community (EC) or European Free Trade Area.
- The product is installed and used in accordance with our instructions and is only used domestically, i.e. a normal household.
- The product is installed taking into account regulations in your new country.

Before you move please contact your nearest Customer Care Centre, listed below, to give them details of your new home. They will then ensure that the local Service Organisation is aware of your move and able to look after you and your appliances.

France	Senlis	+33 (0)344 62 20 13
Germany	Nurnberg	+49 (0)800 234 7378
Italy	Pordenone	+39 (0)800 11 75 11
Sweden	Stockholm	+46 (0)20 78 77 50
UK	Slough	+44 (0)1753 219898



# Installation

## Positioning

The appliance may be placed in any room, provided the following precautions are taken.

The appliance expels hot, very moist air. The rest of the house must be able to easily absorb this moisture.

Normally, absorption is only possible in houses where there is very little humidity. Otherwise, the room must have ventilation towards the outside; generally, an open door or window is enough.

The capacity of the venting circuit must be at least 150 m<sup>3</sup>/hour. Check that the air inlet and outlet vents are unobstructed.

The best way of evacuating the moisture is through a vent hose to the outside of the building. Use the special 100 mm diameter flexible hose supplied with the appliance connected to one of the air outlet vents with the collar supplied.

The unused outlets must be covered.

Never connect the air vent hose into an existing discharge pipe or duct, as this could be dangerous, might disturb neighbours and could cause the dryer to malfunction.

**This product is supplied with a 2.50 metre vent hose, although the maximum length of the vent hose may be: 4 metres with no bends, or 2 metres with 2 bends.**

**Advice:** If the hose is long and the room temperature low, the moisture might condense to water inside the hose.

**This is an unavoidable natural phenomenon.** To prevent this water from lying in the hose or flowing back into the tumble dryer, it is advisable to drill a small hole (dia. 3 mm) in the lowest point of the hose and to place a small container below it. (See picture, point A).

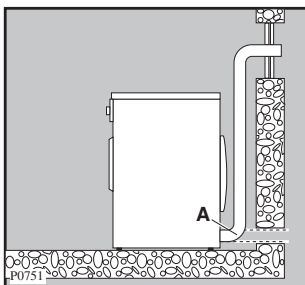

Connect the other end of the hose to an opening in a door or window. Fit a suitable shield or point the hose downwards to prevent any rain water and wind from getting in.

Rain and wind shields for placing over openings usually consist of valves or movable flaps. Periodically check the shield since strong winds and other factors (rust, dirt) can sometimes prevent it from opening, so causing problems with air venting.

If you use a rain shield, check that the openings in it are large enough to allow air to escape. Openings which are too small restrict the flow of air.

Problems can be encountered in rooms fitted with a very powerful central extractor fan. If you find that drying times are too long, switch off the extractor or close its grille whilst the tumble dryer is in use.

A highly effective solution is to simply poke the vent hose through a window or skylight. This might however cause problems in winter because the dryer will draw in very cold (and often also very damp) air through the open window, so increasing drying times and leading to very high energy consumption.

**If the dryer is fitted next to kitchen units, make sure that the vent hose is not squashed. If the hose is partially squashed, drying efficiency will be reduced, resulting in longer drying times and higher energy consumption.**

**If the hose is completely squashed, the safety cut-outs with which the machine is fitted may operate.**

## Condensation discharge through the vent hose

Condensation may be discharged either through a vent outlet provided at the back or through the left or right side outlet.

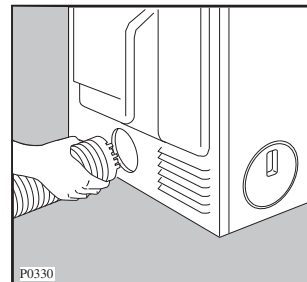

The vent hose collar is placed in the rear vent outlet. Remove the collar by pulling it out of the vent outlet. Screw the collar to the vent hose. Fit the hose into the required vent outlet, and place vent covers provided over the unused outlets.

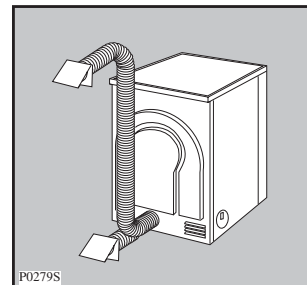

The vent hose must not contain more than two bends when it is placed in position for operation.

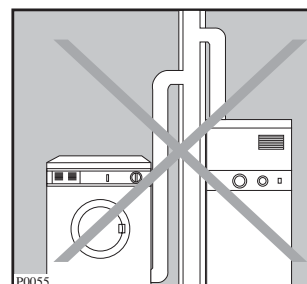

You should **NOT** connect the flexible vent hose to, for example, a chimney or flue pipe designed to carry the exhaust from a fuel burning heating appliance.

The tumble dryer must be installed in a clean place, where dirt does not build up.

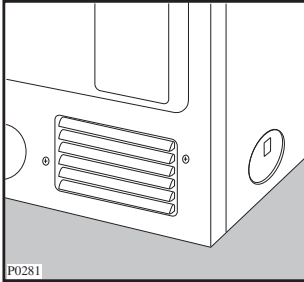

Make sure there are no obstructing items or material near the air-intake louvres provided at the back (e.g. paper, rags etc.).

### Important

When operating the tumble dryer, the room temperature must not exceed 35°C, as it may affect the performance of the appliance.

To save energy, the room temperature should not be lower than +15°C.

### Levelling

Level the tumble dryer into place by screwing or unscrewing the front feet as required.

**Accurate levelling will keep vibration and noise to a minimum when the dryer is in use.**

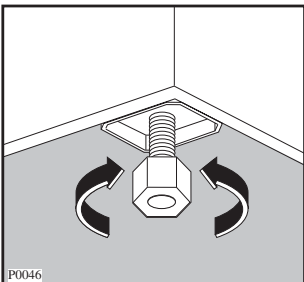

### Door reversal

To make it easier to load or unload the laundry the door can be reversed.

**This operation must be carried out by qualified personnel.**

Operate as follows:

- Remove the door by unscrewing the two screws (1) fastening the hinge to the cabinet (Fig. A).
- Remove the safety catch (2) and the plug (3) by bending the two fastening tags (Fig. A).
- Refit the safety catch (2) and plug (3) on the door by reversing their positions (Fig. B).
- Remove the plastic plate (4) by unscrewing the two fastening screws (Fig. A).
- Refit the the plastic plate (4) on the opposite side (Fig. B).
- Refit the door by screwing in the two screws (1) which fasten the door to the cabinet (Fig. B).

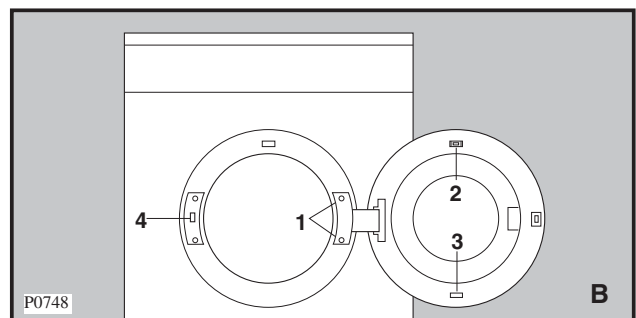
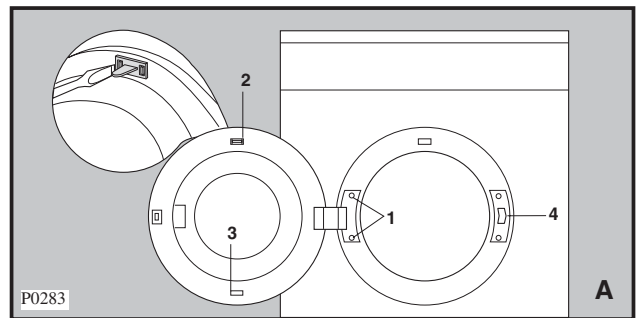

## Electrical connection

Any electrical work required to install this appliance should be carried out by a qualified electrician or competent person.



**WARNING: THIS APPLIANCE MUST BE EARTHED.**

**The manufacturer declines any liability should this safety measure not be observed.**

If the plug that is fitted to your appliance is not suitable for your socket outlet, it must be cut off, and the appropriate plug fitted.

Remove the fuse from the cut off plug. The cut off plug should then be disposed of to prevent the hazard of electric shocks, in case it should be plugged into a 13 Amp socket in another part of your home.

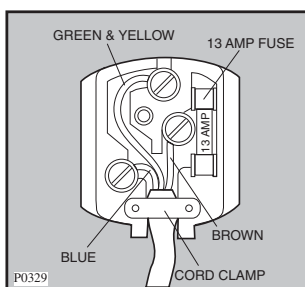

### IMPORTANT

The wires in the mains lead are coloured in accordance with the following code:

Green and Yellow - Earth

Blue - Neutral

Brown - Live

If you fit your own plug, the colours of the wires in the mains lead of your appliance may not correspond with the markings identifying the terminals in your plug.

To fit the plug, proceed as follows:

Connect the green and yellow (earth) wire to the terminal in the plug which is marked with the letter «E» or the earth symbol  $\perp$ , or coloured green and yellow.

Connect the blue (neutral) wire to the terminal in the plug which is marked with the letter «N» or coloured black.

Connect the brown (live) wire to the terminal in the plug which is marked with the letter «L» or coloured red.

The plug moulded on to the lead incorporates a fuse. For replacement, use a 13 Amp BS1363 fuse. Only ASTA or BSI approved fuses should be used.

The plug must not be used if the fuse cover/carrier is lost. The cover/carrier is indicated by the coloured insert at the base of the plug.

A replacement cover/carrier must be obtained from your local Tricity Bendix Service Centre (see page 10).

Avoid connecting the tumble dryer to the same socket as your washing machine (or any other appliance) by means of an adaptor. Have an extra socket installed if necessary, by a qualified electrician.

### Note

Installation, and, in particular, connection to the electric mains and to the discharge vent must be carried out by a competent person or qualified electricians.

Please ensure that when the appliance is installed it is easily accessible for the engineer, in the event of a breakdown.

# TRICITY BENDIX

Tricity Bendix, 55-77 High Street - Slough - Berkshire - SL1 1DZ

---

**Consumer care telephone number 08705 950950**

 **From the Electrolux Group. The world's No. 1 choice.**

*The Electrolux Group is the world's largest producer of powered appliances for kitchen, cleaning and outdoor use. More than 55 million Electrolux Group products (such as refrigerators, cookers, washing machines, vacuum cleaners, chain saws and lawn mowers) are sold each year to a value of approx. USD 14 billion in more than 150 countries around the world.*

## Free Manuals Download Website

<http://myh66.com>

<http://usermanuals.us>

<http://www.somanuals.com>

<http://www.4manuals.cc>

<http://www.manual-lib.com>

<http://www.404manual.com>

<http://www.luxmanual.com>

<http://aubethermostatmanual.com>

Golf course search by state

<http://golfingnear.com>

Email search by domain

<http://emailbydomain.com>

Auto manuals search

<http://auto.somanuals.com>

TV manuals search

<http://tv.somanuals.com>