

TRICITY BENDIX

OPERATING & INSTALLATION
INSTRUCTIONS

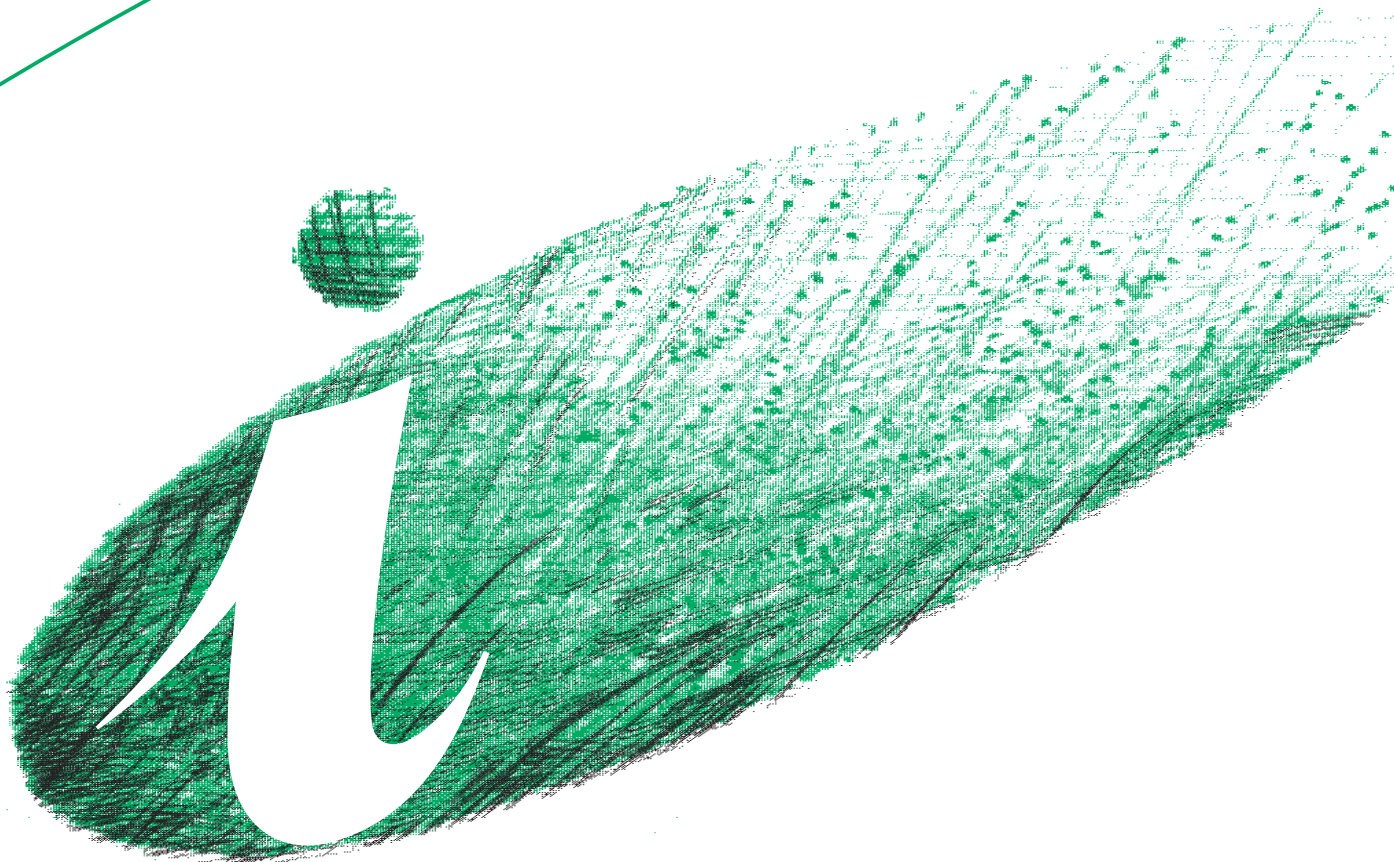

TUMBLE DRYER

TM 320 W

125980573



Important Safety Information

It is most important that this instruction book should be retained with the appliance for future reference. Should the appliance be sold or transferred to another owner, or should you move house and leave the appliance, always ensure that the book is supplied with the appliance in order that the new owner can get to know the functioning of the appliance and the relevant warnings.

These warnings have been provided in the interest of safety. You **MUST** read them carefully before installing or using the appliance.

Installation

- This appliance is heavy. Care should be taken when moving it.
- It is dangerous to alter the specifications or attempt to modify this product in any way.
- Any electrical work required to install this appliance should be carried out by a qualified electrician or competent person.
- Care must be taken to ensure that the appliance does not stand on the electrical supply cable.
- If the machine is situated on a carpeted floor, please adjust the feet in order to allow air to circulate freely.
- If the tumble dryer is placed on top of a washing machine, it is compulsory to use the stacking kit (available as an accessory).

Child Safety

- This appliance is designed to be operated by adults. Children should not be allowed to tamper with the controls or play with the product.
- Pets and children have been known to climb into tumble dryers. Please check your drum before use.
- Keep all packaging well away for children.

Use

- Do not overload the appliance (see programme chart).
- Clothes which are dripping wet should not be placed in the dryer.
- As some bulky items such as duvets and eiderdowns should be dried in large commercial machines because of their bulk, check with the manufacturer of the item if it is suitable for drying in a domestic machine, even if the dry weight of the item is within the limit advised.
- Please make sure that no gas lighters or matches have accidentally been left in pockets of garments to be loaded into appliance.

- **Danger of explosion:** Never tumble dry items that have been in contact with inflammable solvents (petrol, methylated spirits, dry cleaning fluid and the like). As these substance are volatile, they could cause an explosion. Tumble dry only items washed with water.
- Risk of fire: items that have been spotted or soaked with vegetable or cooking oil constitute a fire hazard and should not be placed in the tumble dryer.
- If you have washed your laundry with stain remover you must execute an extra rinse cycle before loading your tumble dryer.
- In order to avoid danger of fires caused by excessive drying, do not use appliance to dry the following items:
Cushions, quilts and the like (these items accumulate heat).
Items containing rubber foam or materials similar to rubber foam.
- Leave the door slightly ajar when the appliance is not being used. This will allow the seal to be preserved.
- Clean fluff filters after using tumble dryer. To prevent fire risks, do not use the appliance if the fluff filters are damaged.
- Do not allow fluff to accumulate around the dryer.
- Under no circumstances should you attempt to repair the machine yourself. Repairs carried out by inexperienced persons may cause injury or serious malfunctioning. Contact your local Tricity Bendix Service Centre. Always insist on genuine Tricity Bendix spare parts.

Contents

For the User

Important Safety Information	2
• Installation	2
• Child Safety	2
• Use	2
Your New Tumble Dryer	4
Description of the Appliance	4
The Control Panel	5
• Programme Chart	5
• Mains-on Light	5
• Low Temperature Button	5
• Start Button	5
• Water Full Indicator Light	5
• Time Selector Dial/On-Off Switch	5
Programme Chart	6
Operating Sequence	7
Hints & Tips on Drying	8
Maintenance and Cleaning	9
• External cleaning	9
• Cleaning the door	9
• Cleaning fluff filters	9
• Cleaning the condenser unit	9
• Emptying the water reservoir	10
• Cleaning the air intake grille	10
Something Not Working	11
Customer Care	11
Guarantee Conditions	12

For the Installer

Installation Instructions	13
Technical Specifications	13
• Unpacking	14
• Positioning	14
• Stacking kit (optional accessory)	14
• Door reversal	14
• Electrical connection	14-15

Guide to use the Instruction Book

The following symbols will be found in the text to guide you throughout the instructions:



Safety instructions



Hints and tips



Environmental information

Your New Tumble Dryer

This tumble dryer will give your wash that soft, relaxed feel whatever the weather. Extremely high quality standards both during development and manufacturing guarantee a long service life for your appliance. Maximum economy in the operation of your dryer is achieved through very frugal electricity consumption and short drying times.

Energy saving tips

To save energy we recommend that you follow these hints:

- Try to load the maximum capacity of the machine as small loads are **uneconomical**.
- Always load well spun laundry. The higher the spin speed, the lower the electricity consumption and the shorter the drying times.
- Do not over-dry laundry, this avoids creasing and saves energy.
- Clean the filters regularly to avoid excessive drying times and high electricity consumption.
- Ventilate the room well. The room temperature should not exceed +35°C during drying.



In the interest of the environment

- Materials marked with the symbol  are recyclable.
- Check with your local Council or Environmental Health Office to see if there are facilities in your area for re-cycling this appliance.

- When the appliance is to be scrapped, cut off the power supply cable and make the door closing device unusable to prevent young children from being trapped inside.
- Help to keep your country tidy - use authorised disposal sites for your old appliance.

How do we help to protect the environment? We use recycled paper!

• Old appliance

The symbol  on the product or on its packaging indicates that this product may not be treated as household waste. Instead it shall be handed over to the applicable collection point for the recycling of electrical and electronic equipment. By ensuring this product is disposed of correctly, you will help prevent potential negative consequences for the environment and human health, which could otherwise be caused by in appropriate waste handling of this product. For more detailed information about recycling of this product, please contact your local city office, your household waste disposal service or the shop where you purchased the product.

Description of the Appliance

- 1 Worktop
- 2 Programme chart
- 3 Control panel
- 4 Fluff filters
- 5 Rating Plate
- 6 Condenser unit
- 7 Water reservoir
- 8 Adjustable feet

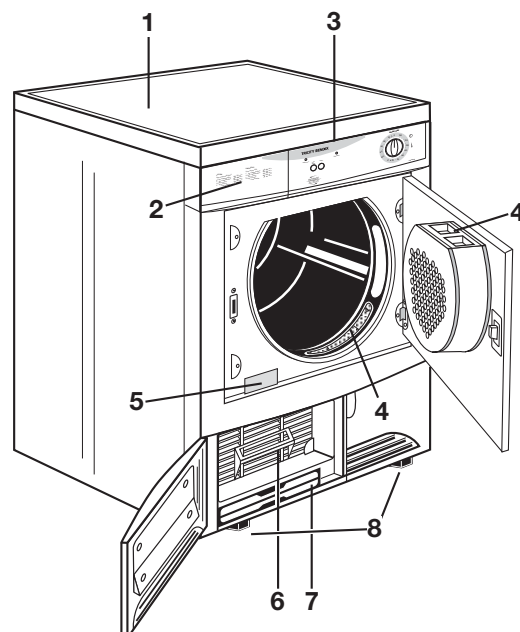

The Control Panel

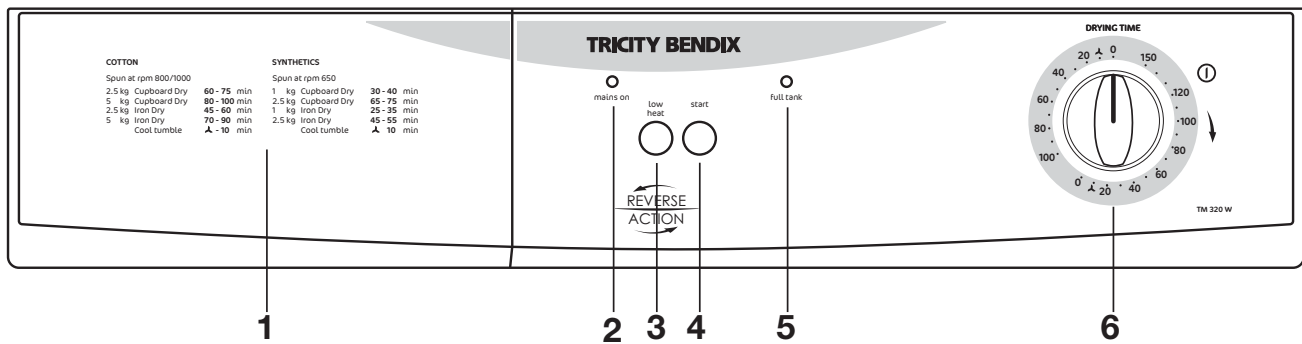

1 Programme Chart

This will help you to select the correct time for drying.

2 Mains on Light

This lights up when the machine starts operating and goes out when the selector dial is on position "0" and when you open the door of the appliance or the small door covering the condenser at the bottom.

3 Low Heat Button

Press this button to reduce the temperature when drying particularly delicate cotton or linen items. In this case you should select a longer drying time.

4 Start Button

Press this button to start the dryer after having selected the programme.

If the door of the appliance or the small door at the bottom is opened while the programme is running, this button must be pressed again after closing the door(s) in order to restart the programme from the point at which it was interrupted.

5 Full tank Light

This light illuminates when the reservoir is full or incorrectly fitted.

6 Time Selector Dial / On Off Switch

Around the knob there are two drying cycles, one of up to 150 minutes at a high temperature for cotton and linen, and one of up to 100 minutes at a low temperature for synthetic fabrics. To set the machine to the selected time, turn the dial **clockwise** until the the knob pointer coincides exactly with the time you want.

NEVER attempt to turn the dial in an anticlockwise direction.

When selecting the drying time you should remember that it includes a 10 minute cooling phase (position ▲ on the dial).

This phase should not be shortened, stopped or avoided, as this could cause skin burns or damages to the laundry.

On "0" position the dryer is switched off.

Programme Chart

Cottons

Selector dial up to 150 minutes (high temperature section)

Type of laundry	Degree of drying	Amount of laundry	Drying time in minutes for laundry spun at
			800/1000 rpm
Cotton Towelling Shirts Sheets Hand towels Tablecloths Table napkins	Cupboard dry	5 kg	80 - 100
		2.5 kg	60 - 75
	Iron dry (not completely dry; suitable for ironing)	5 kg	70 - 90
		2.5 kg	45 - 60

Synthetics

Selector dial up to 100 minutes (low temperature section)

Type of laundry	Degree of drying	Amount of laundry	Drying time in minutes for laundry spun at a minimum speed of 650 rpm
Synthetics or mixed fabrics which do not require ironing.	Cupboard dry	2.5 kg	65 - 75
		1 kg	30 - 40
Synthetics or mixed fabrics which require ironing.	Iron dry (not completely dry; suitable for ironing)	2.5 kg	45 - 55
		1 kg	25 - 35

Attention! Please follow the instructions on labels when drying mixed fabrics.

Drying times are given as a guide only and vary according to the size of the load, the type of laundry, the degree of spinning prior to drying.

Start by selecting a short drying time. If necessary, perform an additional drying cycle afterwards.

Experience will soon enable you to estimate the drying time needed for your usual laundry loads. It is advisable to take note of them.

Size of load

It is not necessary to weigh the laundry, if these instructions are followed:

- Cottons, linen: full drum, but not overloaded.
- Synthetics: half drum.

For a mixed load (cotton and synthetics, for example) select the drying time suitable for the most delicate fabrics and then increase it by approx 10 mins.

Operating Sequence

Before using your tumble dryer for the first time, we recommend you place a few damp cloths inside the appliance and dry for 20 minutes. There may be dust inside a brand new tumble dryer.

Drying

1. Connect the appliance.
2. Open the door as per picture.

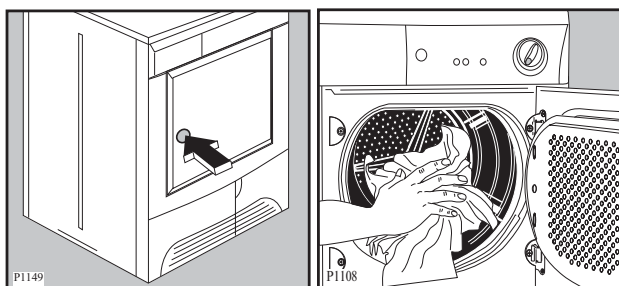

3. Load the items one at a time, shaking them out loosely.
4. Close the door. Please check the laundry does not get caught between the door and filter.
5. Select the drying time by turning the Time Selector Dial clockwise.
6. If required, press the “low heat” Button.
7. Press the Start Button: the machine starts operating. The “mains on” light comes on. The drum turns alternately in both directions during drying.

All drying programmes end with a 10 minute cooling phase (position  on selector dial). The machine stops automatically at the end of this phase (knob pointer on position “O”). The mains-on light goes out.

8. Immediately remove the laundry.

After each use

- Clean the filters (see page 9).
- Empty the water reservoir (see page 10).

Important!

If the drying programme has to be stopped before it reaches the end, we recommend that you turn the Time Selector Dial to position  (cooling) and wait until the end of this phase before removing the laundry. This will avoid a build-up of heat inside the appliance.





Modifying the programme

To change a programme which is running, turn the Time Selector Dial clockwise to the required position.

Hints & Tips on Drying

Before placing articles of laundry in your tumble dryer, check the care labels to ensure they are recommended for tumble drying.

Care Labels you may find on your laundry

-  may be tumble dried
-  normal drying (high temperature)
-  delicate drying (low temperature)
-  do not tumble dry

 **Do not overload the appliance.**

Here is a list of the approximate weight of some common laundry items.

Sheet	700 to 1000 g
Pillowcase	100 to 200 g
Tablecloth	400 to 500 g
Table Napkin	50 to 100 g
Kitchen Towel	70 to 120 g
Linen Hand Towel	100 to 150 g
Hand Towel	150 to 250 g
Bath Towel	700 to 1000 g
Bathrobe	1000 to 1500 g
Shirt	200 to 300 g
Apron	150 to 200 g

- Always load well spun laundry. The higher the spin speed the lower the electricity consumption and the shorter the drying time.
- DO NOT load dripping wet laundry into the dryer. Roll the article in a towel or spin to remove excess water.
- Close poppers and zips and fasten any buttons.
- Sort the laundry. Separate synthetics from cotton/linens, and dry separately.
- Remove the laundry immediately after the programme has finished.
- Use a fabric conditioning sheet to reduce static. We recommend the sheet is pinned to an article of laundry (using a safety pin).
- Mix the load i.e. large and small articles.
- When drying large items such as sheets, we recommend you periodically stop the dryer to redistribute the load.

DO NOT use the tumble dryer to dry the following:

- Articles contaminated with inflammable substances e.g. petrol, cleaning solvents, cooking oil, fats or hair lacquer.
- Woollen and synthetic/wool mixtures unless the item is labelled as suitable for tumble drying.
- Very delicate articles such as silk.
- Very large and bulky items such as duvets or sleeping bags.

Maintenance and Cleaning

You must **disconnect** the appliance from the electricity supply, before you can carry out any cleaning or maintenance work.

External cleaning

Use only soap and water and then dry thoroughly.

Important: do not use methylated spirit, diluents or similar products.

Cleaning the door

Clean periodically the interior part of the door to remove any fluff from the seals around the filter. Regular cleaning ensures correct drying.

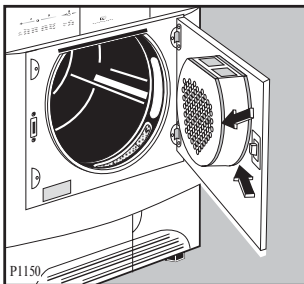

Cleaning the filters

Your dryer will only function well if the filters are clean.

The filters collect all the fluff which accumulates during drying and they must therefore be cleaned at the end of each programme, before removing the laundry, with a damp cloth.

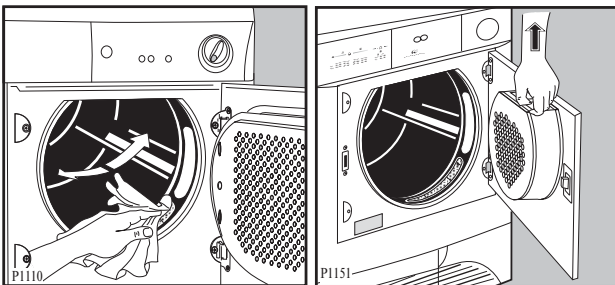

The filter in the inner door must be removed for cleaning.

Do not be alarmed by the amount of fluff. It is not due to excessive wear caused by the dryer. All fabric loses fluff when drying but it goes un-noticed in the air. In a tumble dryer it simply collects in the filter.

After a while, a whitish patina due to detergent residue on laundry forms on the filters. When this occurs, clean the filters (specially the filter in the door opening) with warm water using a brush. Remove it as per picture (it can be positioned with the tooth facing to the left or to the right).

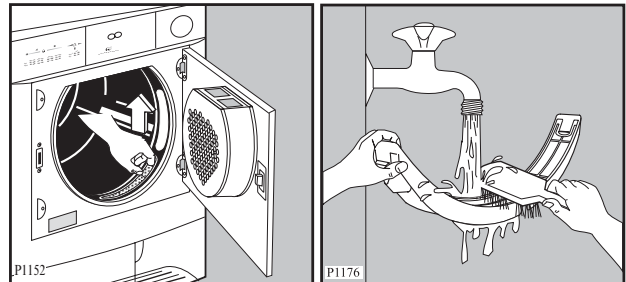

 **Do not use the appliance without filters.**

Cleaning the condenser unit

Clean the air condenser periodically, 3 or 4 times a year depending on how frequently the dryer is used.

The condenser is situated at the lower part of the cabinet behind a small door. To open the door, push the catch as shown in the picture.

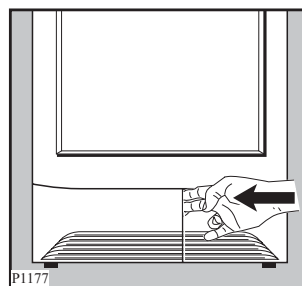

To pull out the condenser, first turn the two red stops inwards as shown and then remove the condenser unit holding it at the handle.

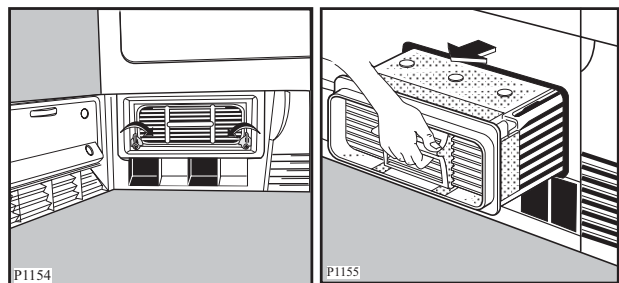

Clean it with a brush and rinse it under the shower if necessary.

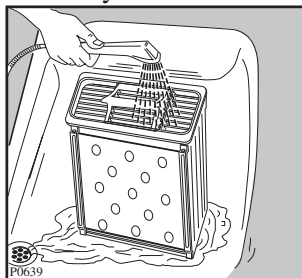

Also clean the outside, removing all fluff.

Clean the rubber seal round the condenser cabinet and in the inner part of the small door with a damp cloth.

Important! Do not use pointed objects or utensils to clean the spaces between the plates, as this could damage the condenser and make it permeable.

Re-fit the condenser, turn the red stops upwards and close the door.



Do not use this appliance if the condenser has not been fitted.

Emptying the water reservoir

Water extracted from the laundry condenses inside the machine and is collected in a reservoir. The reservoir must be emptied after each drying cycle to ensure efficient operation when the machine is next used.

If this is not done a safety device trips: pilot light  on the control panel comes on and the programme stops, leaving the laundry damp.

The reservoir can be emptied even in the middle of a programme.

Proceed as follows:

- Open the small door at the lower part of the cabinet
- Turn the yellow stop upwards
- Pull out the reservoir
- Open the small cover and let water flow down
- Close the small cover and re-insert correctly the reservoir
- Push it until it clicks and turn the yellow stop downwards to lock firmly it
- Close the small door and press the START/PAUSE button again to allow the programme to continue.

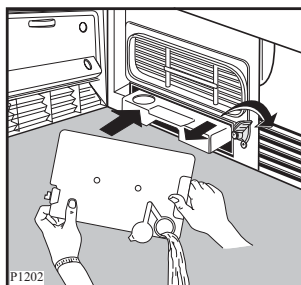

The reservoir must be re-inserted correctly.

The reservoir must be re-inserted correctly. Push it until it clicks.

After inserting the reservoir the programme will continue after about 20 seconds.

Handy tip: The condensed water may be used in a steam iron or to top up a battery, etc. In this case it must be filtered (e.g. through a coffee filter)

Cleaning the air intake grille

Using a vacuum cleaner remove the fluff from the air intake grille at the back of the appliance.

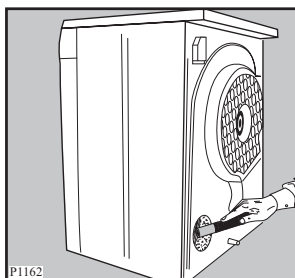

Something Not Working

Certain problems are due to lack of simple maintenance or oversights, which can be solved easily without calling out an engineer. Before contacting your local Service Centre, please carry out the checks listed below.

IMPORTANT: if you call out an engineer to a fault listed below, or to repair a fault caused by incorrect use or installation, a charge will be made even if the appliance is under guarantee.

Symptom	Possible causes
The tumble dryer does not start	<ul style="list-style-type: none"> • The door(s) has(have) not been closed. • The plug is not properly inserted in the power socket. • There is no current at the socket. • The main fuse or the fuse in the plug has blown. • The selector dial is not set correctly. • The Start Button has not been depressed. • The water reservoir is full or not properly inserted (the pilot light “full tank” is on).
Drying takes too long or laundry is not dry enough.	<ul style="list-style-type: none"> • The laundry has not been spun properly. • The filters and/or the condenser are clogged up. • The water reservoir is full or not correctly inserted. • The room temperature is too high. • The selected time or drying sector was not suitable for the laundry. • The “low heat” function has been selected. • There is too much laundry inside the appliance. • The dryer is not correctly installed.

If after the above checks, there is still a fault, call your local Tricity Bendix Service Force Centre.

Service & Spare Parts

In the event of your appliance requiring service, or if you wish to purchase spare parts, please contact your local Tricity Bendix Service Force Centre by telephoning:

0870 5 929929

Your telephone call will be automatically routed to the Service Force Centre covering your post code area.

For the address of your local Service Force Centre and further information about Service Force, please visit the website at www.serviceforce.co.uk.

Before calling out an engineer, please ensure you have read the details under the heading “Something Not Working”.

When you contact the Service Force Centre you will need to give the following details:

1. Your name, address and post code
2. Your telephone number
3. Clear and concise details of fault
4. The model and serial number of the appliance (found on the rating plate - see picture on page 4).
5. The purchase date

Customer Care

For general enquiries concerning your Tricity Bendix appliance or for further information on Tricity Bendix products, please contact our Customer Care Department by letter or telephone as follows:

Customer Care Department

Major Appliances

Addington Way

Luton

Bedfordshire

LU4 9QQ

Tel 08705 950950*

* calls to this number may be recorded for training purposes.

Guarantee Conditions

Standard guarantee conditions

We, Tricity Bendix undertake that if, within 12 months of the date of the purchase, this Tricity Bendix appliance or any part thereof is proved to be defective by reason only of faulty workmanship or materials, we will, at our option, repair or replace the same **FREE OF ANY CHARGE** for labour, materials or carriage on condition that:

- The appliance has been correctly installed and used only on the electricity supply stated on the rating plate.
- The appliance has been used for normal domestic purposes only, and in accordance with the manufacturer's instructions.
- The appliance has not been serviced, maintained, repaired, taken apart or tampered with, by any person not authorised by us.

All service work under this guarantee must be undertaken by a Tricity Bendix Service Force Centre.

Any appliance or defective part replaced shall become the Company's property.

This guarantee is in addition to your statutory and other legal rights.

Home visits are made between **8.30am** and **5.30pm** Monday to Friday. Visits may be available outside these hours in which case a **premium** will be charged.

Exclusions

This guarantee does not cover:

- Damage or calls resulting from transportation, improper use or neglect, the replacement of any light bulbs or removable parts of glass or plastic.
- Costs incurred for calls to put right an appliance which is improperly installed or calls to appliances outside the United Kingdom.
- Appliances found to be in use within a commercial environment, plus those which are subject to rental agreements.
- Products of Tricity Bendix manufacture which are **NOT** marketed by Tricity Bendix.

European guarantee

If you should move to another country within Europe then your guarantee moves with you to your new home subject to the following qualifications:

- The guarantee starts from the date you first purchased your product.
- The guarantee is for the same period and to the same extent for labour and parts as exists in the new country of use for this brand or range of products.
- The guarantee relates to you and cannot be transferred to another user.
- Your new home is within the European Community (EC) or European Free Trade Area.
- The product is installed and used in accordance with our instructions and is only used domestically, i.e. a normal household.
- The product is installed taking into account regulations in your new country.

Before you move please contact your nearest Customer Care Centre, listed below, to give them details of your new home. They will then ensure that the local Service Organisation is aware of your move and able to look after you and your appliances.

France	Senlis	+33 (0)344 62 20 13
Germany	Nurnberg	+49 (0)800 234 7378
Italy	Pordenone	+39 (0)800 11 75 11
Sweden	Stockholm	+46 (0)20 78 77 50
UK	Luton	+44 (0)8705 950950

Installation Instructions

 It is dangerous to alter the specifications or attempt to modify this product in any way.

 Care must be taken to ensure that the appliance does not stand on the electrical supply cable.

 Any electrical work required to install this appliance should be carried out by a qualified electrician or competent person.

Technical Specifications

DIMENSIONS	Height Width Depth	85 cm (33.5") 60 cm (23.6") 58 cm (22.8")
POWER SUPPLY VOLTAGE TOTAL POWER ABSORBED		230-240 V/50 Hz 2450 W (13A)
MAXIMUM RECOMMENDED LOAD	Cotton, linen Synthetics	5 kg 2.5 kg
DRUM VOLUME		108 l
CONSUMPTIONS	Cotton, linen Cotton, linen Synthetics	3.64 kWh (5 kg store dry) 3.0 kWh (5 kg iron dry) 1.4 kWh (2,5 kg store dry)

 This appliance complies with the following E.E.C. Directives:
- 73/23 EEC of 19.2.73 (Low Voltage Directive) and subsequent modifications;
- 89/336 EEC of 3.5.89 (Electromagnetic Compatibility Directive) and subsequent modifications.

Unpacking

Warning !

-  Slide out the polythene bag containing the polystyrene block before using the appliance.
- Pull off adhesive strips from inside machine on top of drum.

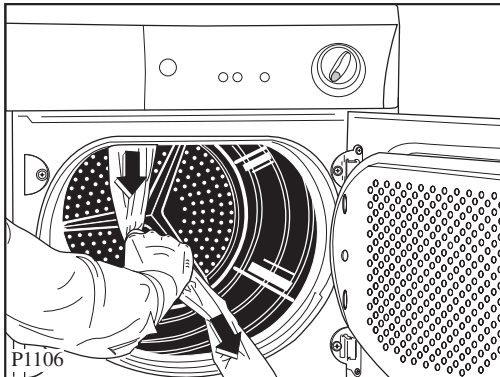

-  **Should the appliance be moved, it must be transported vertically.**

Positioning

It is recommended that, for your convenience, the machine is positioned close to your washing machine.

The tumble dryer must be installed in a clean place, where dirt does not build up.

Air must be able to circulate freely all round the appliance. Do not obstruct the front ventilation grille or the air intake grille at the back of the machine.

To keep vibration and noise to a minimum when the dryer is in use, it should be placed on a firm, level surface.

Once in its permanent operating position, check that the dryer is absolutely level with the aid of a spirit level. If it is not, raise or lower the feet until it is.

The feet must never be removed.

Do not restrict the floor clearance through deep-pile carpets, strips of wood or similar. This might cause heat build-up which would interfere with the operation of the appliance.

Important

The hot air emitted by the tumble dryer can reach temperatures of up to 60°C. The appliance must therefore not be installed on floors which are not resistant to high temperatures.

When operating the tumble dryer, the room temperature must not be lower than +5°C and higher than +35°C, as it may affect the performance of the appliance.

Stacking kit (optional accessory)

It should be possible to stack your new dryer on top of a front loading washing machine with a worktop depth of between 48 and 60 cm.

The instructions are supplied with the kit.

Please contact your Local Service Force Centre for further advice.

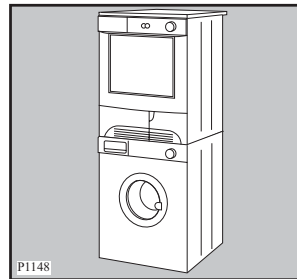

Door reversal

To make it easier to load or unload the laundry the door can be reversed.

This operation must be carried out by qualified personnel.

Please contact the nearest Service Force Centre.

This will be a chargeable option.

Electrical connection

Any electrical work required to install this appliance should be carried out by a qualified electrician or competent person.

-  **WARNING: THIS APPLIANCE MUST BE EARTHED.**

The manufacturer declines any liability should this safety measure not be observed. Should the appliance power supply cable need to be replaced, this should be carried out by our Service Centre.

Before switching on, make sure the electricity supply voltage is the same as that indicated on the appliance's rating plate. (See picture on page 4).

The appliance is supplied with a 13amp plug fitted. In the event of having to change the fuse in the plug supplied, a 13amp ASTA approved (BS 1363/A) fuse must be used.

Should the plug need to be replaced for any reason, proceed as described below.
The wires in the mains lead are coloured in accordance with the following code:

Green and Yellow - Earth
Blue - Neutral
Brown - Live

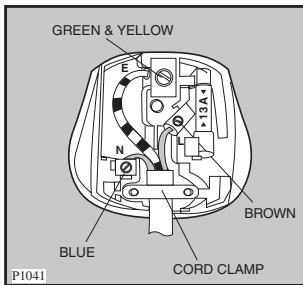

The wire coloured green and yellow must be connected to the terminal marked with the letter «E» or by the earth symbol \perp or coloured green and yellow.

The wire coloured blue must be connected to the terminal «N» or coloured black.

The wire coloured brown must be connected to the terminal marked «L» or coloured red.

Upon completion there must be no cut, or stray strands of wire present and the cord clamp must be secure over the outer sheath.

WARNING:

⚠ A cut off plug inserted into a 13 amp socket is a serious safety (shock) hazard. Ensure that the cut off plug is disposed of safely.

Permanent connection

In the case of permanent connection it is necessary that you install a double pole switch between the appliance and the electricity supply (mains), with a minimum gap of 3mm between the switch contacts and of a type suitable for the required load in compliance with the current electrical regulations.

The switch must not break the yellow and green earth cable at any point.

TRICITY BENDIX

Customer Care Department

Major Appliances

Addington Way

Luton

Bedfordshire

LU4 9QQ

Consumer care telephone number 08705 950950

 **From the Electrolux Group. The world's No. 1 choice.**

The Electrolux Group is the world's largest producer of powered appliances for kitchen, cleaning and outdoor use. More than 55 million Electrolux Group products (such as refrigerators, cookers, washing machines, vacuum cleaners, chain saws and lawn mowers) are sold each year to a value of approx. USD 14 billion in more than 150 countries around the world.

© Electrolux plc 2005

Free Manuals Download Website

<http://myh66.com>

<http://usermanuals.us>

<http://www.somanuals.com>

<http://www.4manuals.cc>

<http://www.manual-lib.com>

<http://www.404manual.com>

<http://www.luxmanual.com>

<http://aubethermostatmanual.com>

Golf course search by state

<http://golfingnear.com>

Email search by domain

<http://emailbydomain.com>

Auto manuals search

<http://auto.somanuals.com>

TV manuals search

<http://tv.somanuals.com>