



# OPERATING AND INSTALLATION INSTRUCTIONS

MODEL NO.  
**CSB4411 / CSB4431**

## TECHNICAL DETAILS

### MODEL NO. CSB4411

Voltage:	230/240 Volts AC 50Hz
Wattage:	10.9/11.9kW
Height:	1290mm
Width:	550mm
Depth:	595mm
Weight:	54kg

### MODEL NO. CSB4431

Voltage:	230/240 Volts AC 50Hz
Wattage:	10.3/12.3kW
Height:	1290mm
Width:	550mm
Depth:	595mm
Weight:	58kg

This appliance complies with: European Council Directive 73/23/EEC.  
EMC Directive 89/336/EEC.  
CE Marking Directive 93/68/EEC.

# CONTENTS

Please refer to the sections in this book which are appropriate to your model.

<b>Technical Details</b> .....	2
<b>Contents</b> .....	3
<b>Preface</b> .....	5
<b>Safety</b> .....	6
Before Installation .....	6
During Operation .....	6
After Use .....	7
General .....	7
<b>Introduction</b> .....	8
Rating Plate .....	8
Installation .....	8
Reversible Main Oven Door .....	9
General Notes On Using Your Cooker .....	9
Condensation and Steam .....	9
Oven and Grill Furniture .....	9
<b>Getting to know your Cooker</b> .....	10
The Control Panel .....	10
The Timer .....	11
<b>The Sealed Hotplates</b> .....	14
Recommended Saucepans .....	14
Hints and Tips .....	14
<b>Deep Fat Frying</b> .....	15
<b>Preserving</b> .....	15
<b>The Grill</b> .....	16
Selecting the Grill (CSB4411) .....	16
Selecting the Grill (CSB4431) .....	16
Things to Note .....	16
The Grill Pan and Handle .....	16
Hints and Tips .....	17
Grilling Chart .....	17
<b>The Top Oven (CSB4431 only)</b> .....	18
Uses of the Top Oven .....	18
Selecting the Top Oven .....	18
To Fit the Top Oven Shelf .....	18
Hints and Tips .....	18
<b>The Oven (CSB4411 only)</b> .....	20
Selecting the Oven .....	20
Things to Note .....	20
To Fit the Oven Shelves .....	20
Hints and Tips .....	20
Oven Cooking Chart .....	21
Oven Roasting Chart .....	22
<b>The Main Fan Oven (CSB4431 only)</b> .....	23
Uses of the Fan Oven .....	23
Selecting The Fan Oven .....	23
Things to Note .....	23
To Fit the Main Oven Shelves .....	23
Hints and Tips .....	24
Roasting Chart .....	24
Oven Cooking Chart (CSB4431 only) .....	25

# CONTENTS

<b>Defrost Feature (CSB4431 only)</b> .....	26
Uses of Defrost Feature .....	26
Selecting Defrost .....	26
Things to Note .....	26
Hints and Tips .....	26
<b>Care and Cleaning</b> .....	27
Cleaning Materials .....	27
Cleaning the Sealed Hotplates and Hotplate Trims .....	27
Things to Note .....	27
Cleaning the Outside of the Cooker .....	27
Cleaning the Grill Deflector, Grill Pan, Grill Pan Grid and Oven Shelves .....	28
Cleaning Inside the Oven/Grill Compartments .....	28
Care of Stayclean Surfaces .....	28
Hints and Tips .....	28
<b>Something not Working?</b> .....	29
<b>Service and Spare Parts</b> .....	30
<b>Customer Service Centres</b> .....	31
<b>Guarantee Conditions</b> .....	33

## PREFACE

Dear Customer,

Thank you for buying a Tricity Bendix cooker. With our 80 years experience in developing and manufacturing the very best in U.K. cookers, you can be assured that you have purchased a hard working, reliable, quality product.

Tricity Bendix cookers comply with British Standard safety and performance requirements. They are covered by a 12 month parts and labour guarantee.

To get the best from your new Tricity Bendix cooker, we ask that you PLEASE READ THESE INSTRUCTIONS CAREFULLY. Particular attention should be made to cooking times and temperatures which may differ from your previous cooker.

It is most important that this instruction book is retained with the appliance for future reference. Should the appliance be sold, or if you move house and leave the appliance, always ensure that the book remains with the appliance. This will enable the new owner to be acquainted with the functioning of the appliance and the relevant warnings.

Please read the whole instruction book before attempting to use the appliance ensuring you follow the recommendations given.

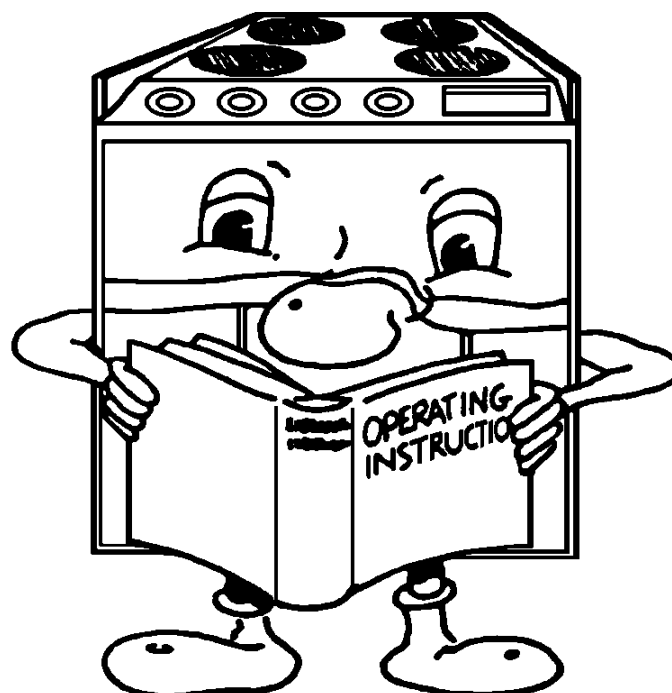

## SAFETY

THESE WARNINGS ARE PROVIDED IN THE INTERESTS OF YOUR SAFETY. ENSURE THAT YOU UNDERSTAND THEM ALL BEFORE INSTALLING OR USING THE COOKER.

PLEASE  
READ  
CAREFULLY



### BEFORE INSTALLATION



This cooker is heavy and care **must** be taken when moving it.



**Ensure** that all packaging, both inside and outside the appliance, has been removed before the appliance is used.

If the cooker is to be placed on a base, measures must be taken to prevent the cooker slipping from the base.



**Do not** try to move the appliance by pulling the door handles.



The electrical installation work **must** be undertaken by a qualified electrician/ competent person.

It is **dangerous** to alter or modify the specifications of the product in any way.

### DURING OPERATION



**Do not** use this cooker if it is in contact with water. **Never** operate it with wet hands.



This appliance is designed to be operated by adults. Young children **must not** be allowed to tamper with the cooker or play with the controls.

During use the cooker becomes **Hot**. Care should be taken to avoid touching heating elements inside the oven.

Accessible parts especially around the grill area may become hot when the cooker is in use. Children should be **kept away** until it has cooled.

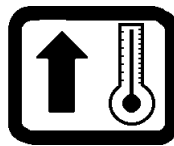

Take **great care** when heating fats and oils as they will ignite if they become too hot.

This product has been designed for cooking edible foodstuffs only, and **must not** be used for any other purposes.



**Never** place plastic or any other material which may melt in the oven or on the hob.



**Ensure** cooking utensils are large enough to contain foods to prevent spillages and boil overs.

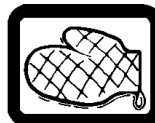

The handles of saucepans which are smaller than the heated area on the hob will become hot. **Ensure** your hand is protected before handling the pan.



**Take care** to follow the recommendations given for tending the food when grilling.

**Ensure** that all vents are left unobstructed to ensure ventilation of the oven.

**Ensure** that the anti-tilt shelves are put in place correctly. Refer to instructions on pages 18 and 20.

**Never** line any part of the appliance with aluminium foil.



**Always** stand back from the appliance when opening the oven door to allow any build up of steam or heat to release.



**Do not** place sealed cans or aerosols inside the oven. They may explode if they are heated.



After installation, please dispose of the packaging with due regard to safety and the environment.

## AFTER USE



**Ensure** that all control knobs are in the OFF position when not in use.



For hygiene and safety reasons this appliance should be kept clean at all times. A build-up of fats or other foodstuffs could result in a fire, especially in the grill pan.



**Do not** leave utensils containing foodstuffs, e.g. fat or oil in or on the appliance in case it is inadvertently switched ON.

Cookers and hobs become **very hot**, and retain their heat for a long period of time after use. Children should be kept well away from the appliance until it has cooled.

## GENERAL



**Under no circumstances** should repairs be carried out by inexperienced persons as this may cause injury or serious malfunction.

This product should be serviced by an authorised Service Engineer and only genuine approved spare parts should be used. Details of servicing and repair arrangements are given on page 31 of this book.



**Do not** stand on the appliance or on the open oven door.



**Do not** hang towels, dishcloths or clothes from the appliance or its handle. They are a safety hazard.



After allowing the cooker to cool always switch OFF the cooker at its power point before any maintenance or cleaning work is carried out.



Only clean this cooker in accordance with the instructions given in this book.

Your safety is of paramount importance.

Therefore, if you are unsure about any of the meanings of these WARNINGS contact the:

Customer Care Department  
Telephone 0870 5 950950

## INTRODUCTION

**WARNING: THIS APPLIANCE MUST BE EARTHED**

### RATING PLATE

Record the model, product and serial numbers on the back cover from the rating plate. This is situated on the front frame of the appliance and can be seen upon opening the oven door.

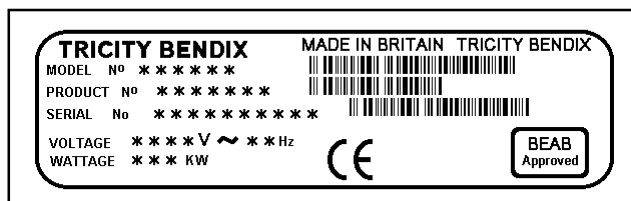

The appliance must be protected by a suitably rated fuse or circuit breaker. The rating of the appliance is given on the rating plate.

**Do not remove the rating plate from the cooker as this may invalidate the guarantee.**

### INSTALLATION

If your cooker has been damaged in transit, contact your supplier immediately. **DO NOT** attempt to install it.

Your cooker left the factory fully packaged to protect it from damage. If it is delivered without packaging and damage has occurred, the manufacturer cannot accept responsibility. Contact your supplier for advice.

Once the packaging has been removed the cooker should only be moved by hand. **DO NOT** use a sack barrow or any other aid to lift the cooker as damage may occur.

Connection to the electricity supply must be carried out by a qualified electrician/competent person.

The electrical connection should be made using a double pole isolating switch (cooker socket) with at least 3mm contact separation. The cable must have conductors of sufficiently high cross-sectional area to prevent overheating and deterioration. Six square millimetres (6.00mm<sup>2</sup>) is the recommended cross-section area.

The cable should be routed away from potentially hot areas marked by X in the diagram below.

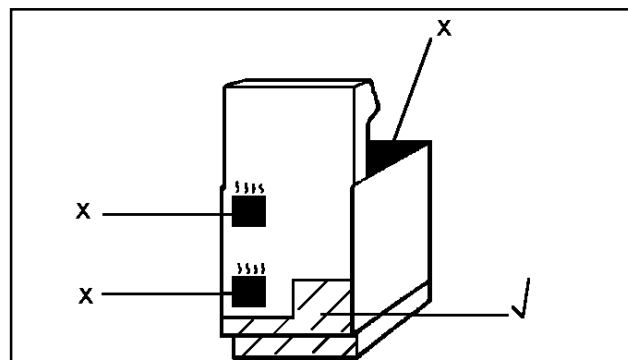

To move the cooker, open the main oven door and lift the cooker by holding inside the top of the compartment.

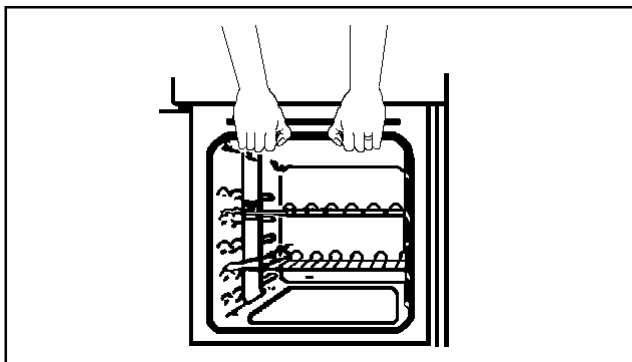

This is a type X appliance which means it is free-standing and can be fitted with cabinets on one or both sides. It may also be fitted in a corner setting.

A nominal air gap of 2mm all around the cooker is required to enable the cooker to be moved into position.

Side walls which are above hob level should be protected by heat resistant non-combustible material and **MUST NOT** be nearer than 40mm to the hob side.

Overhanging surfaces or a cooker hood should be a minimum of 685mm above the hob.

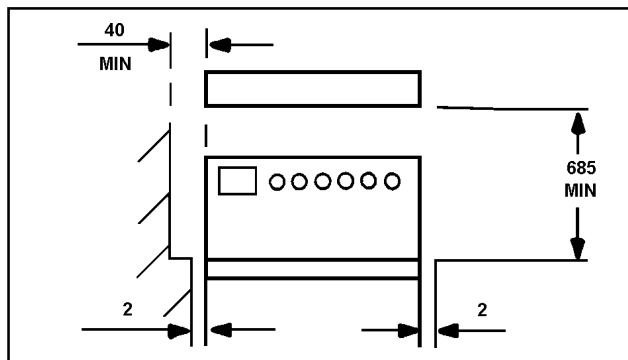

It is important to ensure that the appliance is level after installation. Levelling feet are fitted to the appliance to accommodate uneven floors.



## REVERSIBLE MAIN OVEN DOOR

If you require the oven door to be hinged on the opposite side, you will need to contact a qualified Service Engineer. See page 31 for your nearest Service Centre. PLEASE NOTE that a charge will be made.

## GENERAL NOTES ON USING YOUR COOKER

We suggest that you run the oven elements for 10 - 15 minutes at 220°C to burn off any residue from their surfaces.

The procedure should be repeated with the grill for approximately 5 - 10 minutes.

During this period an odour may be emitted, it is therefore advisable to open a window for ventilation.

## CONDENSATION AND STEAM

When food is heated it produces steam similar to a boiling kettle. The ovens are vented to allow some of this steam to escape. However, always stand back from the appliance when opening the oven door to allow any build up of steam or heat to release.

If the steam comes into contact with a cool surface on the outside of the appliance, e.g. a trim, it will condense and produce water droplets. This is quite normal and is not caused by a fault on the appliance.

To prevent discolouration, regularly wipe away condensation and also soilage from surfaces.

## GRILL AND OVEN FURNITURE

The following items of oven furniture have been supplied with the cooker: If you require replacements of any of the items listed below, please contact your local Service Force Centre quoting the relevant part number.

1 grill pan  
(311409401)

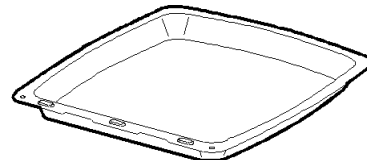

1 detachable grill pan handle  
(311468100)

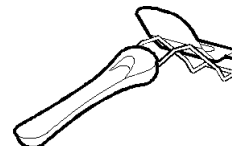

### Note

If you require an additional handle for your grill pan, this can be ordered from your local Tricity Bendix Service Centre by quoting part number 311479800\6.

1 grill pan grid  
(311419801)

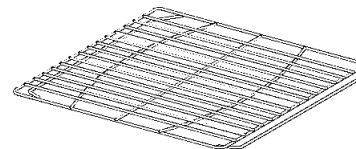

1 grill deflector

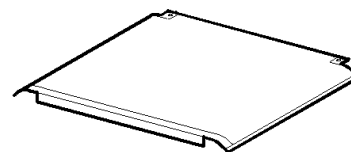

CSB4431 Gourmet only  
2 straight shelves  
for main oven cooking

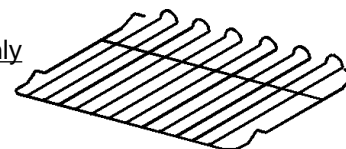

1 cranked shelf for use  
in the top oven

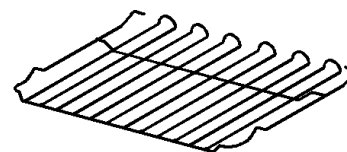

CSB4411 White Rose only  
2 straight shelves  
for main oven cooking

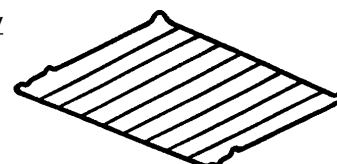

The grill deflector sits above the grill element and prevents fat splashing onto the grill roof. The deflector may be easily removed for cleaning.

## GETTING TO KNOW YOUR COOKER

### THE CONTROL PANEL (CSB4411 WHITE ROSE)

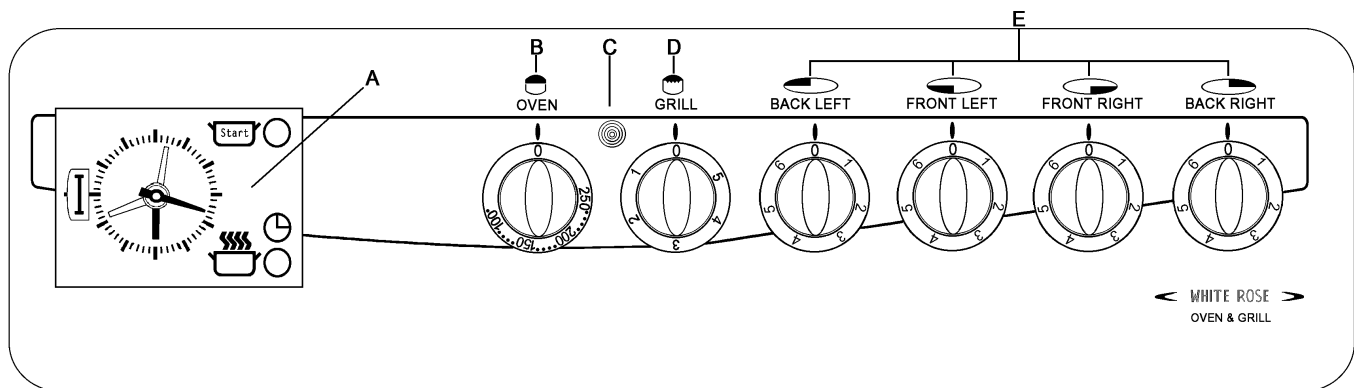

#### FEATURES

- |                              |                       |
|------------------------------|-----------------------|
| A - Timer                    | D - Grill Control     |
| B - Oven Temperature Control | E - Hotplate Controls |
| C - Oven Indicator Neon      |                       |

### THE CONTROL PANEL (CSB4431 GOURMET)

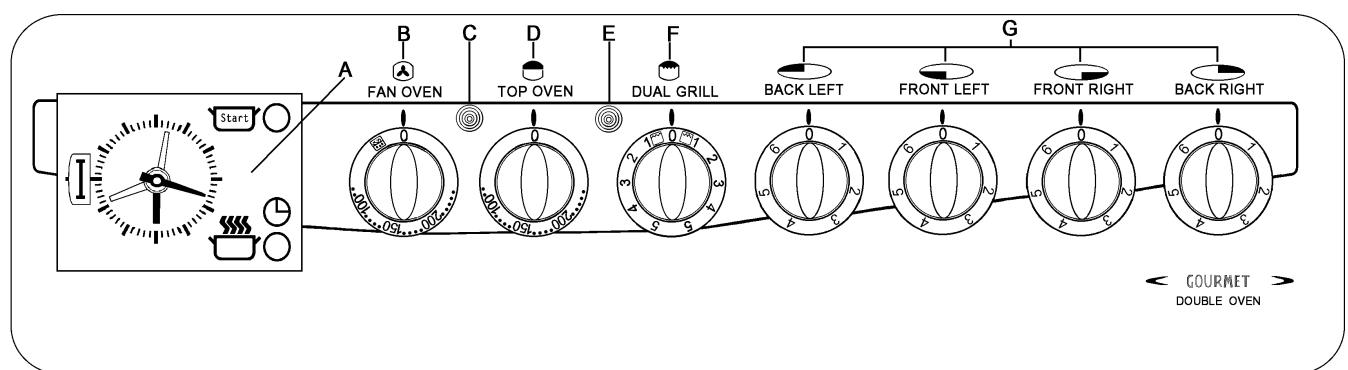

#### FEATURES

- |                                   |                        |
|-----------------------------------|------------------------|
| A - Timer                         | F - Dual Grill Control |
| B - Main Oven Temperature Control | G - Hotplate Controls  |
| C - Main Oven Indicator Neon      |                        |
| D - Top Oven Temperature Control  |                        |
| E - Top Oven Indicator Neon       |                        |

## THE TIMER

- A START TIME SETTING KNOB
- B SECOND HAND
- C CLOCK SYMBOL
- D CLOCK/MINUTE MINDER/LENGTH OF COOKING TIME SETTING KNOB
- E START TIME INDICATOR
- F HOUR HAND
- G DISPLAY WINDOW
- H MANUAL SYMBOL
- J MINUTE HAND

### 1. TO SET THE TIME OF DAY

The clock will operate when the cooker is switched ON at the wall.

To set, **pull out** and turn setting knob (D) clockwise until the right time of day is displayed, e.g. 9 a.m. as Fig.1.

### 2. TO SET FOR MANUAL COOKING

Ensure the time of day has been set as above.

**Push in** and turn setting knob (A) in either direction until the start time indicator (E) lines up with the hour hand of the clock.

**Push in** and turn setting knob (D) clockwise until the manual symbol can be seen in the display window as Fig. 2.

The oven temperature controls can now be operated as required. The oven indicator neon will glow.

### 3. TO SET THE MINUTE MINDER

Turn setting knob (D) clockwise, **without pulling it out**. The selected minutes can be seen in the display window, e.g. 80 minutes as Fig. 3.

A period of up to 3 hours can be timed using the minute minder. The minute minder cannot be used when an automatic programme has been set on the oven timer.

At the end of the set time a continuous buzzer will sound for up to 6 minutes. The oven will switch off.

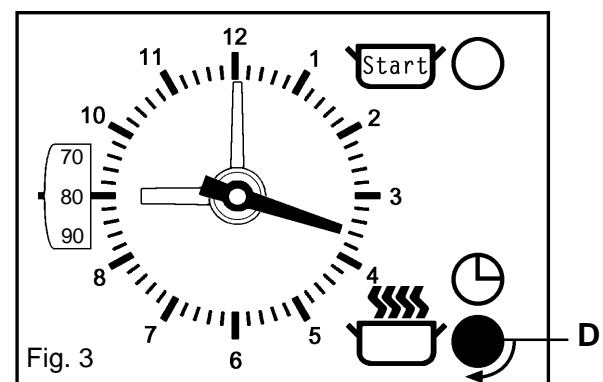
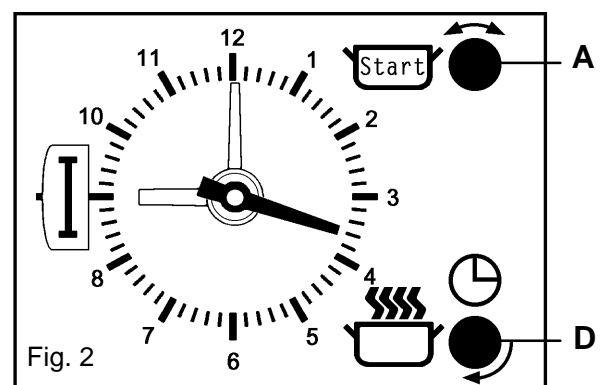
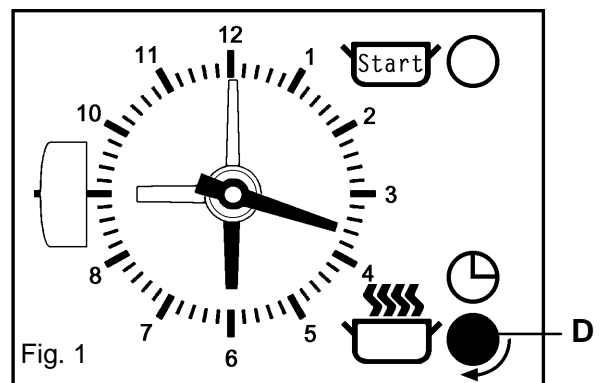
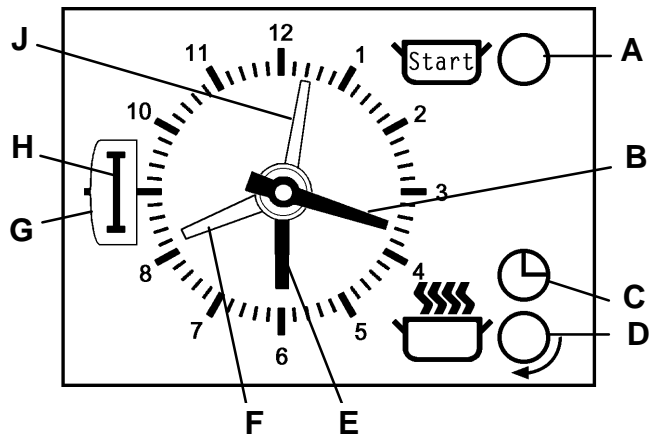

#### 4. TO CANCEL MINUTE MINDER

Turn setting knob (D) clockwise, **without pulling it out** until the manual symbol appears in the display window as Fig.4.

#### 5. HOW TO SET THE OVEN TIMER

When using the oven timer for the very first time, it is advisable to let it operate while you are at home. The timer can be checked to show that it is operating correctly and then you will then feel confident to leave a meal to cook automatically in the future.

##### A) TO SWITCH THE OVEN ON AND OFF AUTOMATICALLY

- i) Make sure the electricity supply is switched ON.
- ii) Check the clock shows the right time of day and the cooker is set in manual (see point 2). Adjust as necessary as Fig. 5.
- iii) Place food in oven.
- iv) To set the length of time you want the food to cook; turn setting knob (D) clockwise, **without pulling it out**, until the required cooking period can be seen in the display window e.g. 160 minutes (2 hours 40 mins) as Fig. 6.
- v) Set the start time, by **pushing in** and turning setting knob (A) in either direction until indicator (E) lines up with the time you want the food to start cooking, e.g. 1.30 p.m. as Fig. 7.
- vi) Turn the oven temperature control to the required setting. The oven indicator neon should be OFF.
- vii) When automatic cooking starts the oven indicator neon will cycle ON and OFF showing that the oven temperature is being maintained.
- viii) The start time indicator will move with the hour hand of the clock until the length of cooking time is complete. A buzzer will sound which can be cancelled by following point 4 as Fig. 8.
- ix) The maximum cooking time on automatic is 3 hours.

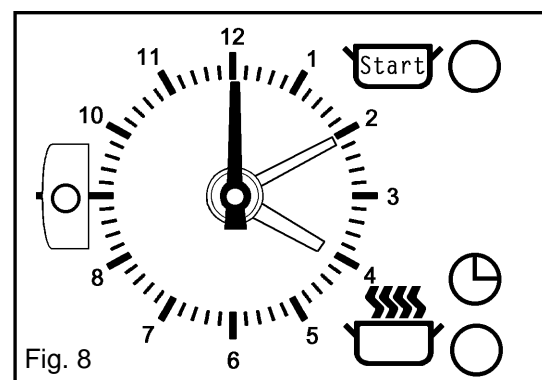
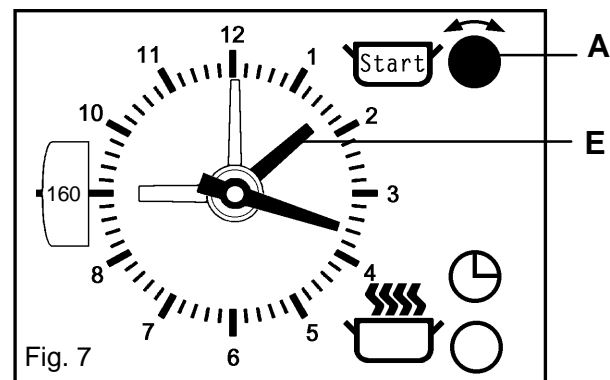
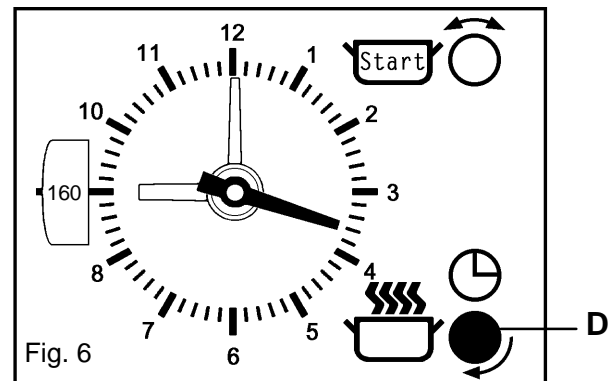
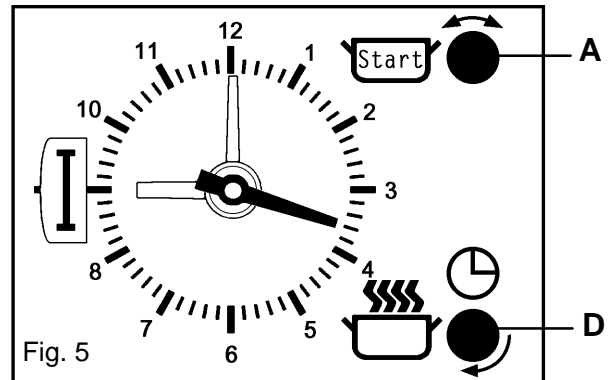
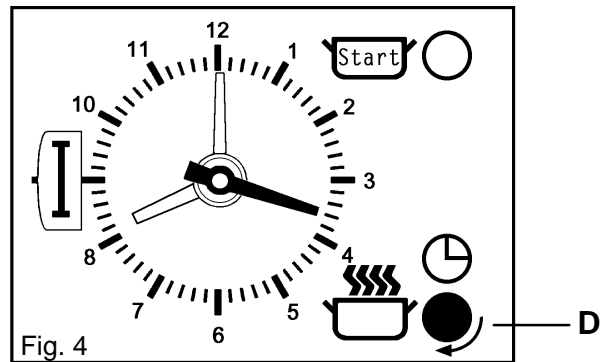

## **B) TO START COOKING NOW, THEN SWITCH OFF AUTOMATICALLY**

Follow the first 3 points under section 5. (A) above, and then;

- iv) To set the length of time you want the food to cook; turn setting knob (D) clockwise, **without pulling it out**, until the required cooking period can be seen in the display window, e.g. 120 minutes (2 hours) as Fig. 9.
- v) Turn the oven temperature control to the required setting. The oven indicator neon should glow.
- vi) The oven indicator neon will cycle ON and OFF showing that the oven temperature is being maintained.
- vii) The start time indicator will move with the hour hand of the clock until the length of cooking time is complete. A buzzer will sound which can be cancelled by following point 4 as Fig. 10.

## **6. RETURNING THE COOKER TO MANUAL OR TO CANCEL AN AUTOMATIC PROGRAMME**

Turn the oven temperature control OFF. Ensure the start time indicator lines up with the hour hand of the clock by **pushing in** and turning in either direction, setting knob (A) Fig. 11.

The manual symbol should be displayed in the display window by turning setting knob (D) clockwise.

Turn the oven temperature control ON to check that the oven operates manually. The oven indicator neon should light.

## **7. THINGS TO NOTE CSB4431 GOURMET ONLY**

The delay time plus the cooking time **MUST NOT** exceed 11 hours and 59 minutes.

- 1 The automatic control can be used to control either oven but you can only use the control for both ovens at the same time if the cooking time is the same.
- 2 When an automatic programme has been set on one oven, **IT IS NOT** possible to use the oven manually.
- 3 If an automatic programme has been set on the main oven, the grill **WILL** operate manually. But the grill **WILL NOT** operate when the top oven is set for automatic cooking.

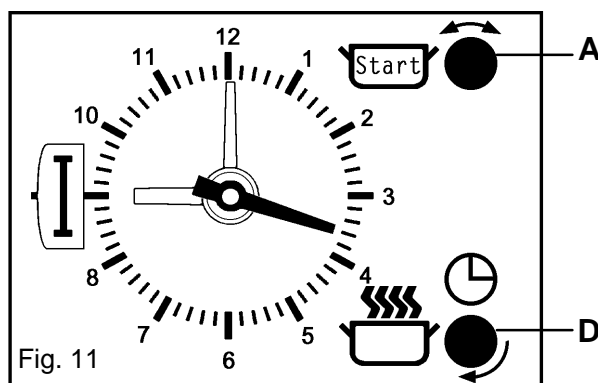
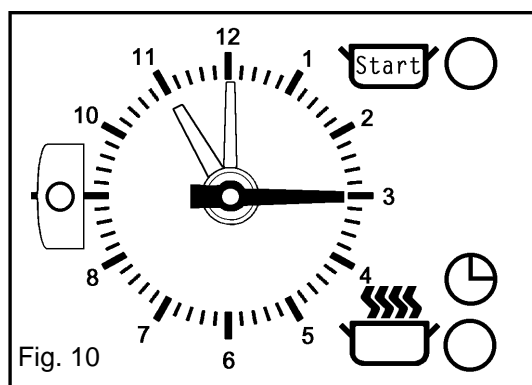
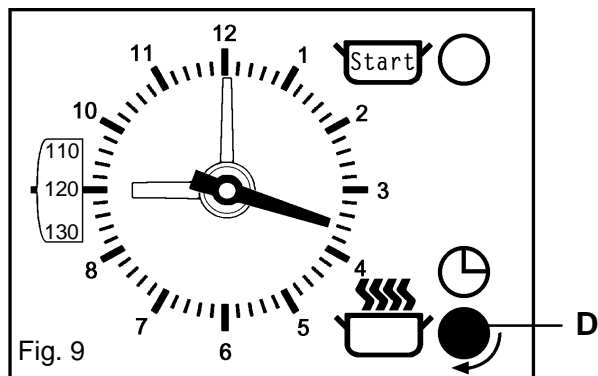

## THE SEALED HOTPLATES

### BEFORE USING THE HOTPLATES FOR THE FIRST TIME

Turn the control knob to a medium/high setting and allow the hotplate to heat, uncovered by a saucepan for 3-5 minutes. This hardens the protective coating on the hotplates and makes it more resistant to normal use. A harmless smoke will be given off from the hotplates.

#### (CSB4411 WHITE ROSE)

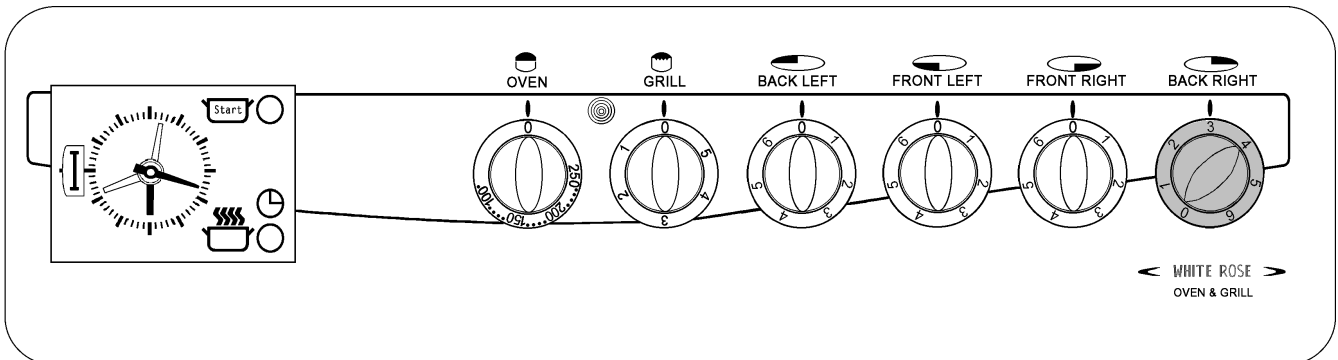

#### (CSB4431 GOURMET)

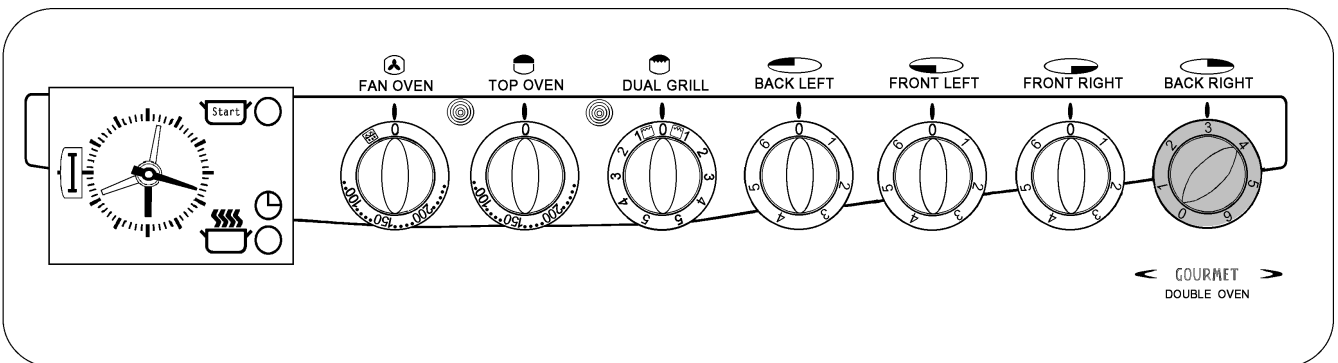

- To operate the hotplates, turn the control knobs in either direction to vary the heat setting.
- The highest number represents the hottest setting and the lowest represents the coolest setting. Choose a setting appropriate to the quantity and type of food to be cooked

### RECOMMENDED SAUCEPANS

For speed and economy only good quality saucepans with flat bases and close fitting lids are recommended.

To check the flatness of the saucepan, place a ruler across the pan base, hold at eye level and look for light showing. There should be very little or no light visible between the ruler and the pan base.

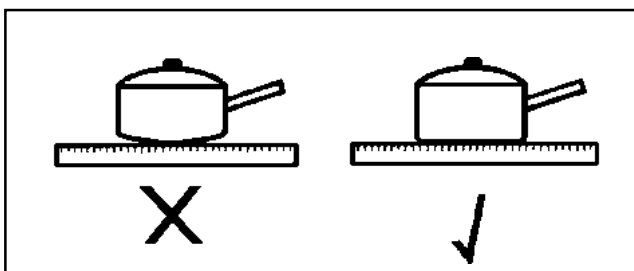

The size of the base of the saucepan should be the same or up to 2.5cm/1inch larger than the hotplate. If the base is too small, energy will be wasted, boilovers will also be more difficult to deal with as spillage will fall directly onto the hotplate.

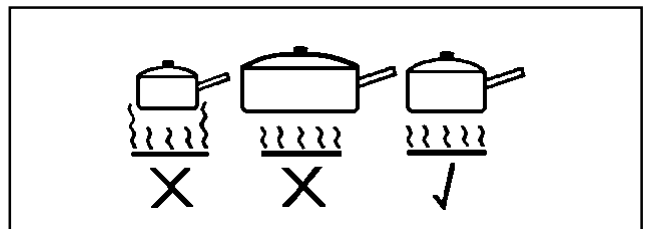

Pressure cookers, preserving pans etc., should comply with the recommendations given above.

### HINTS AND TIPS

- Avoid the use of decorative covers as they can cause condensation to form on the hotplates which may lead to deterioration.
- Follow any guidelines provided by the saucepan manufacturer, particularly those relating to recommended heat settings.
- Avoid using thin, badly dented or distorted saucepans as they can lead to sticking and burning of food.
- To prolong the life of the hotplates:
  - Never use utensils with a skirt, e.g. a bucket
  - Never use an asbestos mat

## DEEP FAT FRYING

### SPECIAL FRYING NOTE:

For safety purposes when deep fat frying, fill the pan one-third full of oil, DO NOT cover the pan with a lid and DO NOT leave the pan unattended. In the unfortunate event of a fire, switch OFF at the electricity supply and cover the pan with a lid or damp cloth to assist in smothering the flames.

DO NOT use water on the fire. Leave the pan to cool for at least 30 minutes before moving it.

DO NOT leave the fat or oil in the frying pan on the hob to store it in case the hob is inadvertently switched ON.

#### 1. Preparing the food

Seal the food by coating with flour, egg and breadcrumbs or batter. **Do not** use a basket with batter coated foods as they will stick.

#### 2. Amount of oil

For safety purposes fill the pan only one-third full of oil.

#### 3. Testing the temperature of the oil

It is advisable to use a thermometer to test the temperature of the oil. Alternatively, drop a small cube of bread into the oil which should brown in just under a minute if the oil is at the correct temperature of 190°C/375°F.

#### 4. Cooking the food

Lower the food gently into the oil. **Do not** add too much food at once or the temperature of the oil will be reduced and may result in soggy, greasy food.

Turn the food if necessary; doughnuts float to the surface so will not brown on the upperside if not turned. Once cooked, drain the food on absorbent paper.

#### 5. Double frying chips

Double frying will ensure good chips. First fry the chips for a few minutes at 170°C/340°F to seal the outside. Remove the chips from the oil. Increase the temperature of the oil to 190°C/375°F to finish cooking and brown the chips.

Chips may be kept for several hours after the first frying before finishing off with the second frying.

#### 6. Frying temperatures

	Celsius Scale (°C)	Fahrenheit Scale (°F)
	150	300
First frying of potatoes	<b>170</b>	<b>340</b>
	175	350
	180	360
Second frying of potatoes	<b>190</b>	<b>375</b>
Frying chicken and fish	195	380
	200	390

## PRESERVING

1. DO NOT use a pan that overlaps the perimeter of the hob trim.

2. To allow for a full rolling boil, the pan should be no more than one third full when all the ingredients have been added. It is better to use two pans rather than overfill one, or use half quantities.

3. Use firm fruit or vegetables and wash well before using.

4. Preserving sugar gives clear jam, however granulated sugar is cheaper and gives equally good flavour.

5. Crystallization may be caused if sugar is not completely dissolved before bringing jam to the boil. Over boiling will affect the flavour, setting properties and colour of the jam.

6. To test jam for setting:

If a jam thermometer is available, boil jam to 104°C. Marmalade should be boiled to 106°C.

If a jam thermometer is not available, remove pan from heat, place sample of jam on a cold dish and cool quickly (i.e. in a freezer or frozen food storage compartment of a refrigerator). When cold, it will crinkle and hold the mark of a finger run through it, if it is at setting point.

7. The scum should be removed as soon as possible after setting, but marmalade should be allowed to cool before potting to prevent the peel rising.

## THE GRILL

**CAUTION - ACCESSIBLE PARTS MAY BECOME HOT WHEN THE GRILL IS IN USE. CHILDREN SHOULD BE KEPT AWAY.**

### SELECTING THE GRILL (CSB4411 WHITE ROSE)

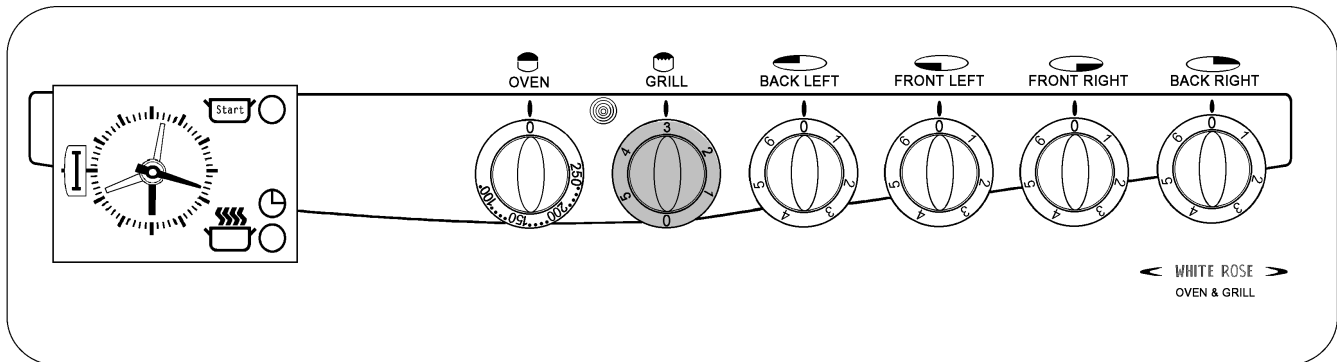

- Turn the grill control to the required setting. The highest number represents the hottest setting and the lowest the coolest setting.

### SELECTING THE GRILL (CSB4431 GOURMET)

The grill is a dual circuit grill which means that the full area of the grill can be used or for economy purposes, the centre section only can be used when cooking smaller quantities of food.

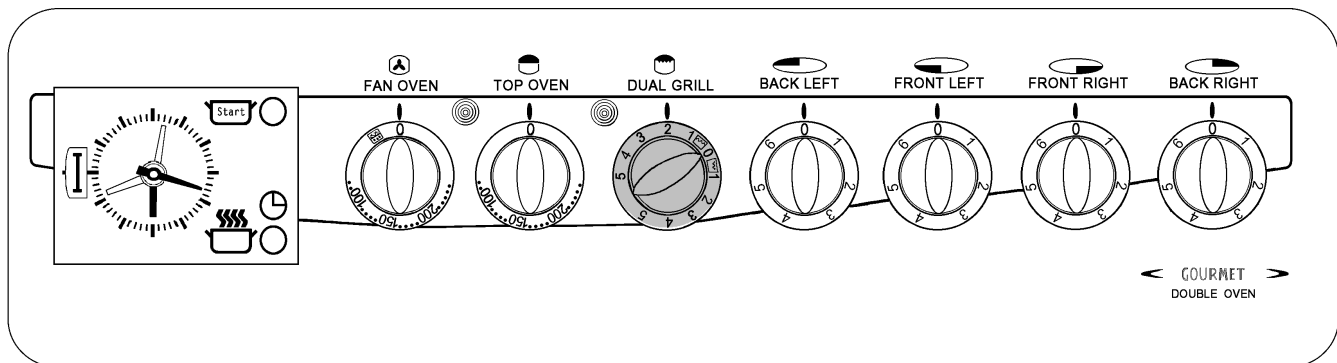

- Turn the grill control clockwise for full grill or anticlockwise for the centre section only. The highest number represents the hottest setting and the lowest the coolest setting.
- The outer grill element may appear to glow slightly brighter than the inner element. This is quite normal.

#### THINGS TO NOTE

THE GRILL DOOR MUST BE LEFT OPEN DURING GRILLING.

#### THE GRILL PAN AND HANDLE

The grill pan is supplied with a removable handle.

To attach the handle, place the wirework under the cut out in the pan so that the metal plate hooks over the top of the grill pan.

Slide the handle to the left and over the central bump on the grill pan.

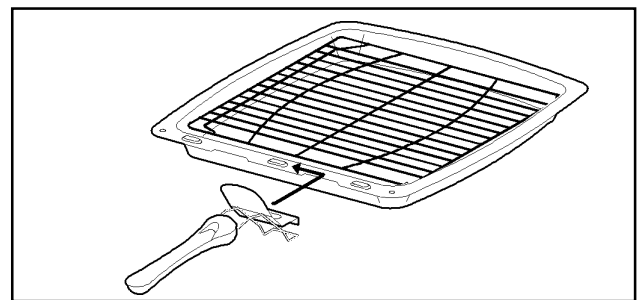

Ensure the handle is correctly located. It is not necessary to remove the grill pan handle during grilling.

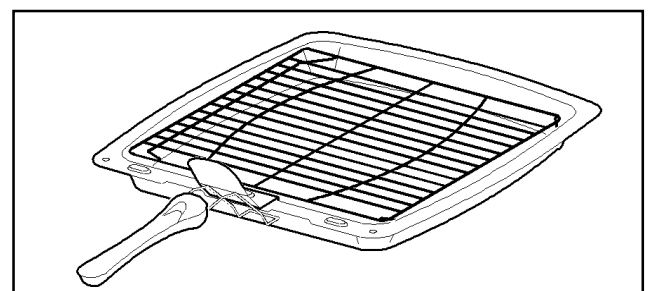



To remove the handle, slide the handle to the right and lift the handle away from the cut out on the grill pan.

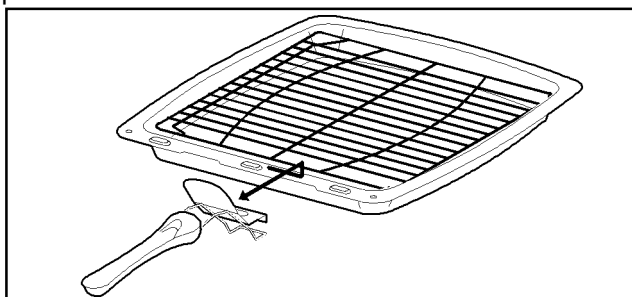

Place the grill pan on the shelf so that the pan is positioned centrally beneath the grill.

To check the progress of the food being grilled, the grill pan should be withdrawn on the shelf to tend the food during cooking, or the carrier shelf can be lifted away from the cooker and rested on a heat resistant work surface.

### HINTS AND TIPS

- Food should be thoroughly dried before grilling to minimise splashing. Brush lean meats and fish lightly with a little oil or melted butter to keep them moist during cooking.
- Adjust the grid and grill pan runner position to allow for different heights of food.
- When toasting bread use the cranked shelf in position 2. Adjust the grill pan grid to suit.
- Accompaniments such as tomatoes and mushrooms may be placed underneath the grid when grilling meats.

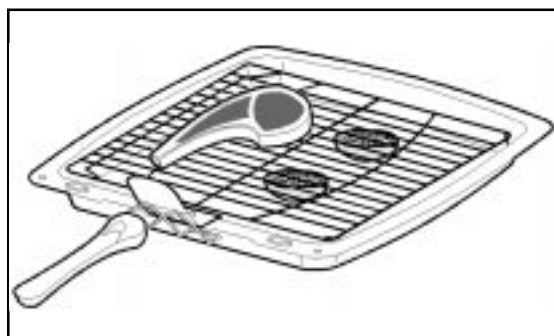

- Preheat the grill on a full setting for a few minutes before cooking. Adjust the heat setting and the shelf as necessary during cooking.
- Turn foods over during the cooking time as required.

### NOTE

If you require an additional handle for your grill pan, this can be ordered from your local Tricity Bendix Service Centre by quoting part number 311479800\6.

## GRILLING CHART

FOOD	SHELF	GRILL TIME
Bacon Rashers	2	2-3 each side
Beefburgers	2	6-10 each side
Chicken Joints	2	15-20 each side
Chops - Lamb	2	7-10 each side
Pork	2	10-15 each side
Fish - Whole Trout/Mackerel	2	8-12 each side
Fillets - Plaice/Cod	2	4-6 each side
Kebabs	2	10-15 each side
Kidneys - Lamb/Pig	2	4-6 each side
Liver - Lamb/Pig	2	5-10 each side
Sausages	2	10-15 each side
Steaks - Rare	2	3-6 each side
Medium	2	6-8 each side
Well Done	2	7-10 each side
Toasted Sandwiches	2	1¼-1½ each side

Shelf positions are counted from the bottom upwards.

The times quoted above are given as a guide and should be adjusted to suit personal taste.

## THE TOP OVEN (CSB4431 GOURMET ONLY)

### USES OF THE TOP OVEN

The top oven is the smaller of the two ovens. It is heated by elements in the top and bottom of the oven. It is designed for cooking on one level and for smaller quantities of food. It gives especially good results if used to cook fruit cakes, sweet or savoury flans or quiche.

The top oven is also ideal for use as a warming compartment to warm dishes and keep food hot. Use a temperature setting of 90-100°C on the top oven control dial.

### SELECTING THE TOP OVEN

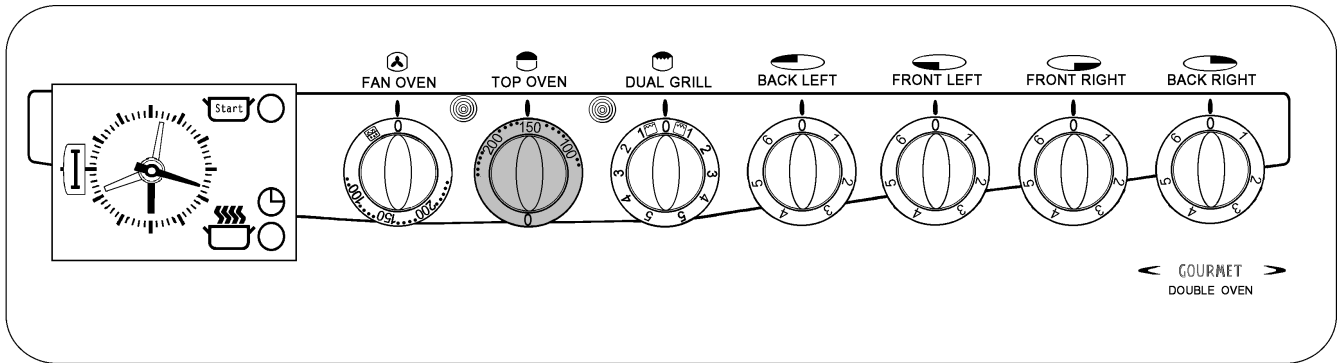

- Turn the top oven temperature control to the required setting. Our diagram shows the oven set to 150°C. Close the oven door.

### THINGS TO NOTE

1. The grill cannot be operated when the top oven is in use. Only the outer part of the top oven element in conjunction with the base element will operate when using the top oven.
2. The top oven indicator neon will glow until the oven has reached the desired temperature and then go out. It will then turn ON and OFF showing that the oven temperature is being maintained.
3. Always place plates on the oven shelf to warm. Never place directly on the top oven base as it becomes very hot and damage may occur.

### TO FIT THE TOP OVEN SHELF

The cranked shelf must only be used in the top oven compartment.

The shelf should be fitted with the straight rods uppermost on the frame and the forms towards the back of the oven. If not fitted correctly the anti-tilt and safety stop mechanism will be affected.

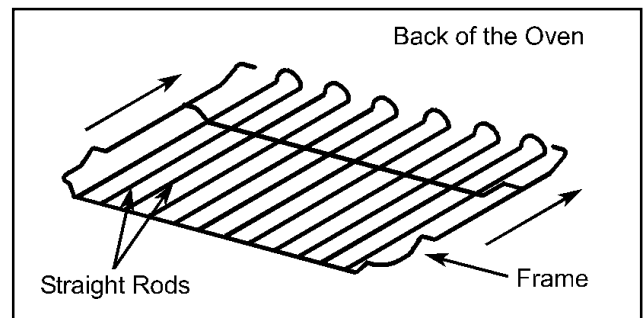

### HINTS AND TIPS

- All cooking should be carried out using an oven shelf positioned in one of the shelf runners.

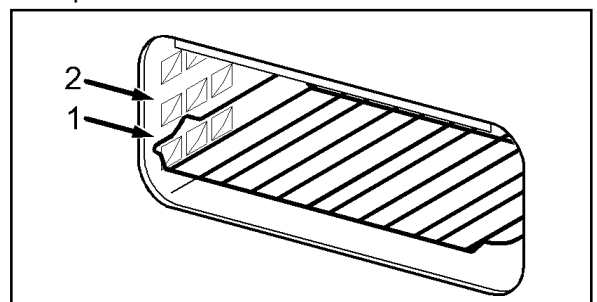

- Stand dishes on a suitably sized baking tray on the shelf to prevent spillage onto the oven base and to help reduce cleaning.

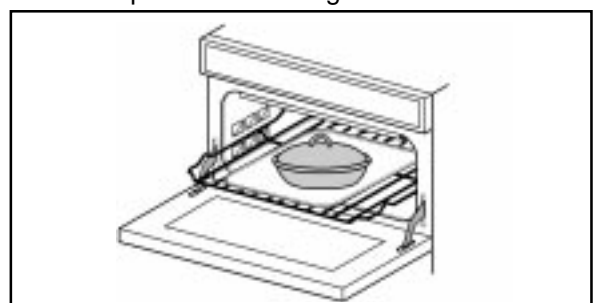

- There should always be at least 2.5cm (1") between the top of the food and the element. This gives best cooking results and allows room for rise in yeast mixtures, Yorkshire puddings, etc.
- When cooking cakes, pastry, scones, bread, etc., place the tins or baking trays centrally on the shelf directly below the element.

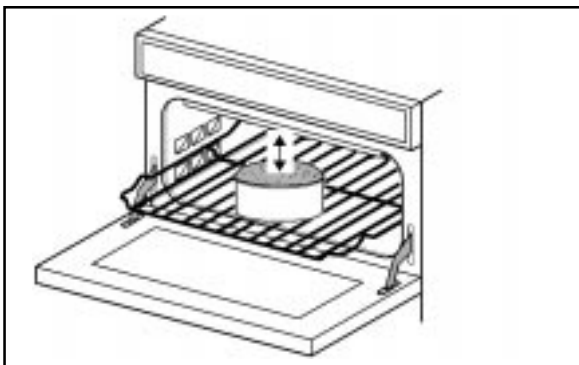

- DO NOT place dishes directly onto the oven base as it becomes very hot and damage may occur.

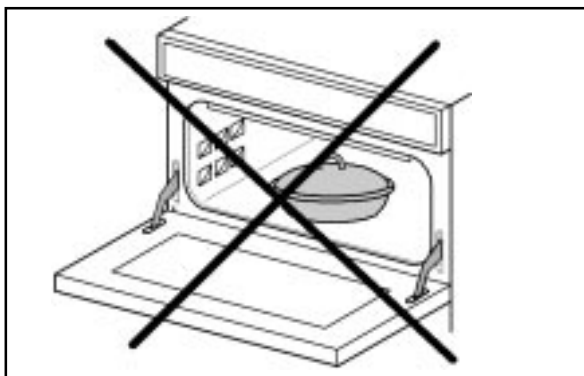

- The material and finish of the baking trays and dishes will affect the degree of base browning of the food. Enamelware, dark, heavy or non-stick utensils increase base browning. Shiny aluminium or polished steel trays reflect the heat away and give less base browning.
- DO NOT use the grill pan as a baking tray as this will increase base browning of the food.
- Because of the smaller cooking space, lower temperatures and shorter cooking times are sometimes required. Be guided by the recommendations on pages 24 and 25.

- For economy leave the door open for the shortest possible time, particularly when placing food into a pre-heated oven.

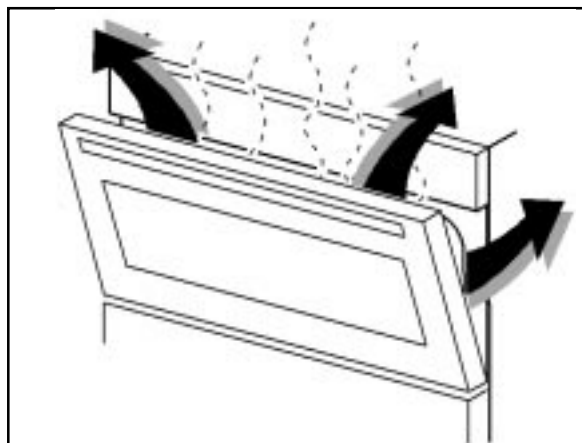

# THE OVEN (CSB4411 WHITE ROSE ONLY)

## SELECTING THE OVEN

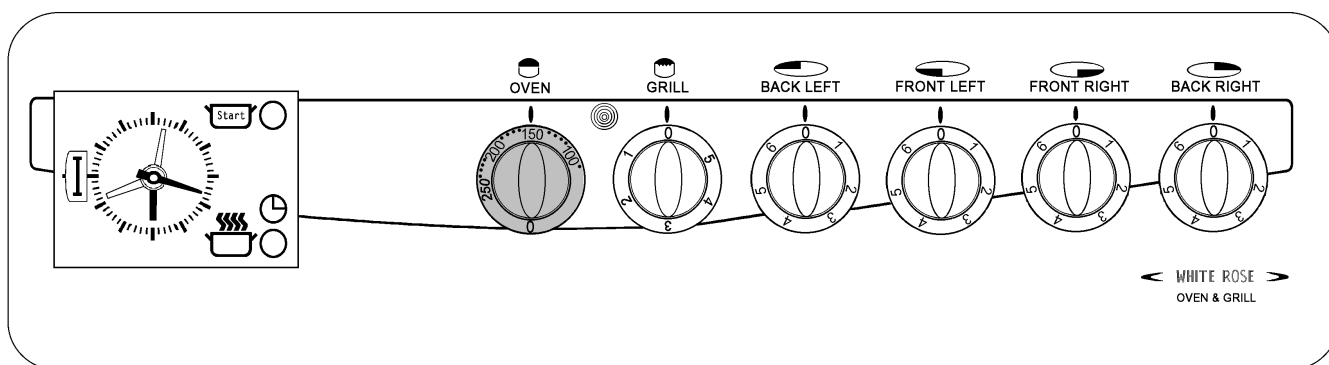

- To operate the oven simply set the oven control dial to the required temperature.

## THINGS TO NOTE

1. The oven indicator neon will glow until the oven has reached the required temperature and then go out.
2. It will turn ON and OFF periodically during cooking showing that the temperature is being maintained.

## TO FIT THE OVEN SHELVES

The shelves should be fitted with the straight rods uppermost on the frame and the forms towards the back of the oven. If not fitted correctly the anti-tilt and safety stop mechanism will be affected.

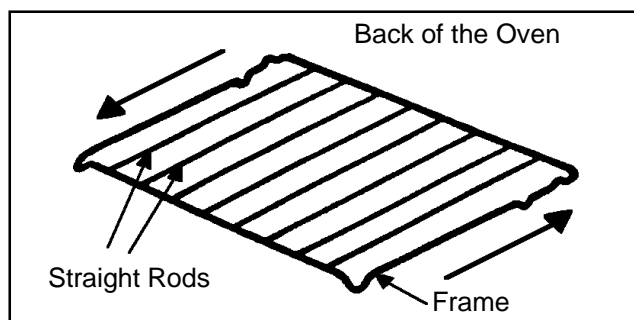

## HINTS AND TIPS

- Arrange the shelves in the required positions before switching the oven ON. Shelves are numbered from the bottom upwards.

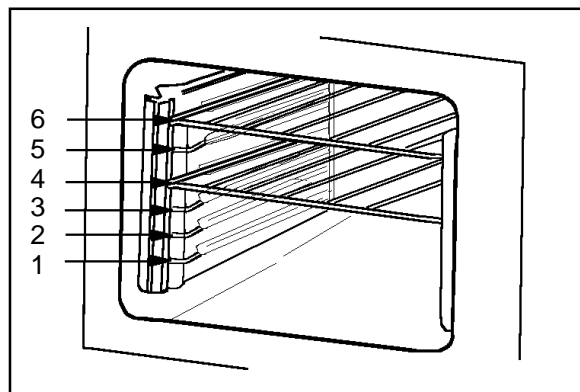

- The oven is fitted with side elements. The top of the oven is the hottest, the bottom the coolest.
- Avoid placing food too close to the side element covers to prevent scorching.

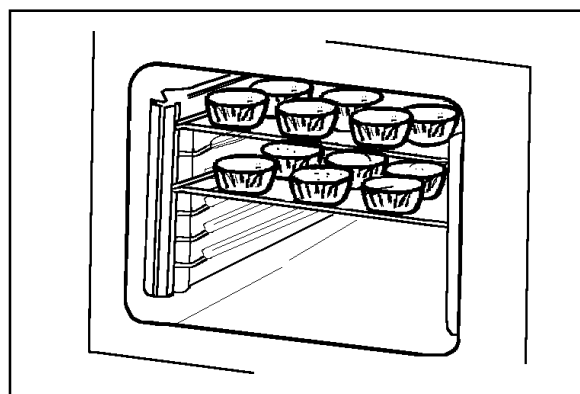

- Do not line any part of the oven with aluminium foil as it may cause damage or interfere with the air circulation.
- Use the recommended temperatures and cooking times given in the oven cooking chart on pages 21 and 22.

## OVEN COOKING CHART (CSB4411 ONLY)

The oven temperatures are intended as a guide only. It may be necessary to increase or decrease the temperatures by 10° C to suit individual preferences and requirements.

Shelf positions are counted from the bottom of the oven.

FOOD	OVEN SHELF POSITIONS	COOKING TEMP (°C)	APPROXIMATE COOK TIME (MINS)
Biscuits	4 and 5	190-200	10-20
Flapjacks	5	180-190	25-30
Shortbread	3	150-160	45-65
Bread			
Bread rolls/buns	1 and 5	210-220	20-30
Casseroles - beef	3	140-150	2-3 hours
Chicken casserole	3	180-190	1½ hours
Cakes: Small & Queen	2 and 5	180-190	20-25
Victoria sandwich	2 and 5	180-190	20-25
Gingerbread	3	150-160	1¼-1½ hours
Madeira	3	170-180	1-1¼ hours
Rich fruit	3	150-160	2¼-2¾ hours
Christmas	2	140-150	Depending on size 3-4½h
Meringues	2	90-100	2½-3 hours
Convenience Foods	Follow manufacturer's instructions		
Fish	3	180-190	20-30
Fish pie (potato topped)			
Shepherds pie	3	200-210	20-25
Fruit pies and crumbles	4	210-220	40-45
Milk puddings	2	150-160	1½-2 hours
Pastry: Choux- Chocolate eclairs	2 and 5	190-200	30-35
Profiteroles	2 and 5	180-190	20-30
Shortcrust- Mince pies	2 and 5	200-210	15-20
Flaky/Puff pies	3	220-230	30-40
Quiche Lorraine/tarts/flan			
Meat pie	5	200-210	30-45
Plate tarts/pies	2 and 5	200-210	30-45
Scones	2 and 5	230-240	8-12
Soufflés	3	200	30-40
Roasting Meat and Poultry	1	180-200	See Roasting Chart
Pasta e.g. Lasagne	3	200	30-40
Vegetable dishes			
Baked jacket potatoes	2 and 4	200	1-1½ hours
Baked stuffed marrow	5	200	30-35
Baked stuffed tomatoes	3	190	20-25
Roast potatoes	5	200-220	1-1½ hours
Yorkshire puddings: (large)	5	230	35-40
(individual)	2 and 5	230	35-40

## ROASTING CHART (CSB4411 ONLY)

MEAT	TEMPERATURES (°C)	
	OVEN	COOKING TIME
Beef	180-200	20-35 minutes per ½kg (1lb) and 20-35 minutes over
Beef, boned	180-200	25-35 minutes per ½kg (1lb) and 25-35 minutes over
Mutton and Lamb	180-200	25-35 minutes per ½kg (1lb) and 25-35 minutes over
Pork and veal	180-200	30-40 minutes per ½kg (1lb) and 30-40 minutes over
Ham	180-200	30-40 minutes per ½kg (1lb) and 30-40 minutes over
Chicken	180-200	15-20 minutes per ½kg (1lb) and 20 minutes over
Turkey and goose	180-200	15-20 minutes per ½kg (1lb) up to 3½kg (7lb) then 15 minutes per ½kg (1lb) over 3½kg (7lb)
Duck	180-200	25-35 minutes per ½kg (1lb) and 25-35 minutes over
Pheasant	180-200	35-40 minutes per ½kg (1lb) and 35-40 minutes over
Rabbit	180-200	20 minutes per ½kg (1lb) and 20 minutes over
Potatoes with meat	180-200	according to size
Potatoes without meat	190-200	according to size

## THE MAIN FAN OVEN (CSB4431 GOURMET ONLY)

### USES OF THE FAN OVEN

#### PREHEATING

The fan oven quickly reaches its temperature, so it is not usually necessary to preheat the oven. Without preheating, however, you may find you need to add an extra 5 - 10 minutes on the recommended cooking times. For recipes needing high temperatures, e.g. bread, pastries, scones, soufflés, etc., best results are achieved if the oven is preheated first. For best results when cooking frozen or chilled ready meals always preheat the oven first.

#### COOKING TEMPERATURES

Fan oven cooking generally requires lower temperatures than conventional cooking. Follow the temperatures recommended in the chart on page 25. As a guide reduce temperatures by about 20°C - 25°C for your own recipes.

#### BATCH BAKING

The fan oven cooks evenly on both shelf levels, especially useful when batch baking.

### SELECTING THE FAN OVEN

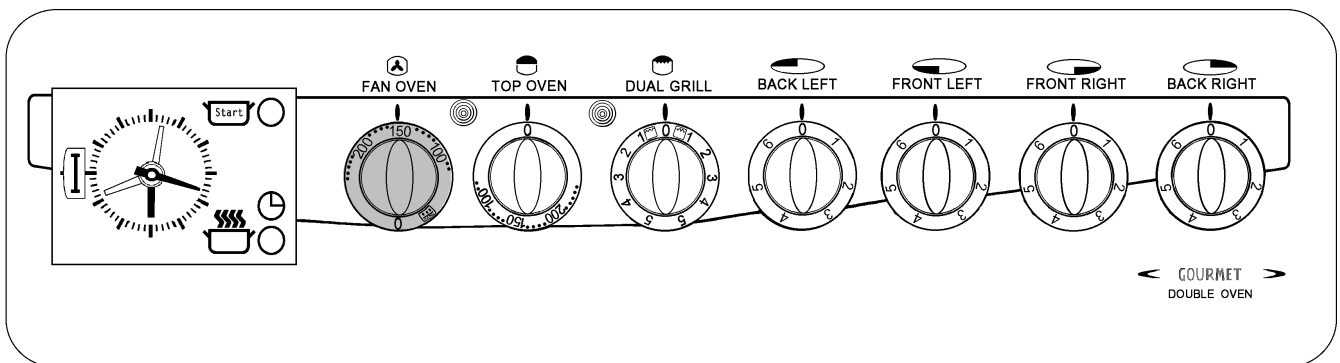

- Turn the oven temperature control to the required setting.

#### THINGS TO NOTE

The main oven indicator neon will glow until the oven has reached the desired temperature and then go out. It will turn ON and OFF periodically during cooking showing that the temperature is being maintained.

#### TO FIT THE MAIN OVEN SHELVES

The shelves should be fitted with the straight rods uppermost on the frame and the forms towards the back of the oven. If not fitted correctly the anti-tilt and safety stop mechanism will be affected.

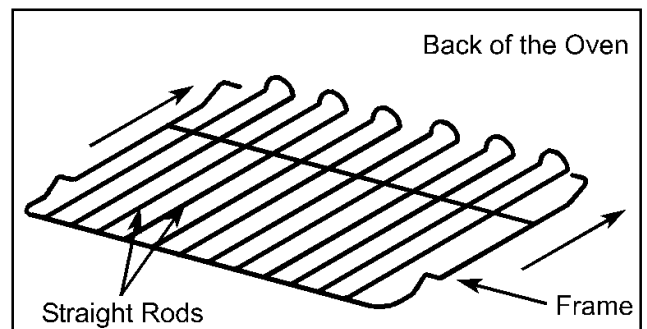

## HINTS AND TIPS

- Arrange the shelves in the required positions before switching the oven ON. Shelves are numbered from the bottom upwards.

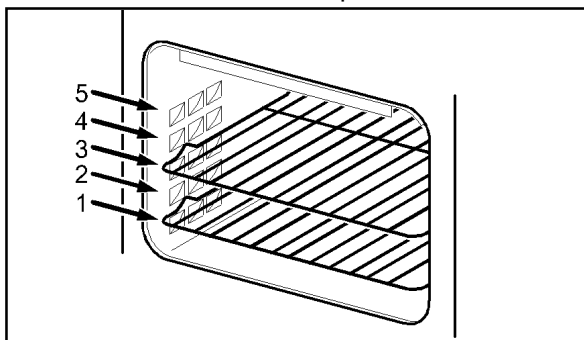

- When cooking more than one dish in the fan oven, place dishes centrally on different shelves rather than cluster several dishes on one shelf. This will allow the heat to circulate freely for the best cooking results.
- When batch baking one type of food, e.g. Victoria sandwich cakes, those of similar size will be cooked in the same time.

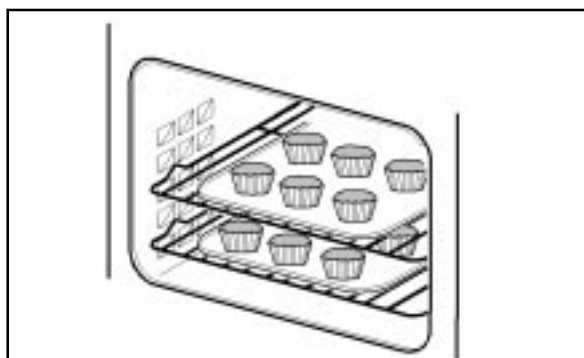

- It is recommended that when baking larger quantities, the shelf positions should be evenly spaced to suit the load being cooked. A slight increase in cooking time may be necessary.
- The use of excessively high temperatures can cause uneven browning. It may be necessary to reduce temperatures slightly. Refer to the recommendations given in the oven cooking chart on page 25.
- Do not use the cranked shelf from the grill in the main oven.

## ROASTING CHART

### INTERNAL TEMPERATURES -

Rare : 50-60°C; Medium : 60-70°C; Well : 70-80°C done

MEAT	TOP OVEN/ FAN OVEN	COOKING TIME
Beef	160-180°C	20-35 min per ½kg/1lb and 20-35 min over
Beef, boned	160-180°C	20-35 min per ½kg/1lb and 25-35 min over
Mutton and Lamb	160-180°C	25-35 min per ½kg/1lb and 25-35 min over
Pork and Veal	160-180°C	30-40 min per ½kg/1lb and 30-40 min over
Ham	160-180°C	30-40 min per ½kg/1lb and 30-40 min over
Chicken	160-180°C	15-20 min per ½kg/1lb and 20 min over
Turkey and Goose	160-180°C	15-20 min per ½kg/1lb up to 3½kg/7lb then 10 min per ½kg/1lb over 3½kg/7lb
Duck	160-180°C	25-35 min per ½kg/1lb and 25-30 min over
Pheasant	160-180°C	35-40 min per ½kg/1lb and 35-40 min over
Rabbit	160-180°C	20 min per ½kg/1lb and 20 min over
Potatoes with meat	160-180°C	according to size
Potatoes without meat	180-190°C	according to size

The roasting temperatures and times given in the chart should be adequate for most joints, but slight adjustments may be required to allow for personal requirements and the shape and texture of the meat. However, lower temperatures and longer cooking times are recommended for less tender cuts or larger joints,

Wrap joints in foil if preferred, for extra browning uncover for the last 30-60 min cooking time.



## OVEN COOKING CHART (CSB4431 ONLY)

The oven temperatures are intended as a guide only. It may be necessary to increase or decrease the temperatures by 10°C to suit individual preferences and requirements.

FOOD	FAN OVEN		TOP OVEN		
	SHELF POSITION	COOKING TEMP °C	SHELF POSITION	COOKING TEMP °C	APPROX COOK TIME (m)
Biscuits		180-190	1	170-190	10 - 20
Bread		200-220	1*	200-220	25 - 30
Bread rolls/buns	Shelf	200-220	1	200-220	15 - 20
Cakes:					
Small & Queen		160-170	1	180-190	18 - 25
Sponges		160-170	1	160-170	18 - 20
Victoria Sandwich	positions	160-170	1	160-170	18 - 25
Madeira		140-150	1	140-150	1¼ - 1½h
Rich Fruit		130-140	1	130-140	2¼ - 2½h
Christmas	are not	130-140	1	130-140	3 - 4½h
					depends on size
Gingerbread		140-150	1	140-150	1¼ - 1½h
Meringues	critical	80-100	1	90-100	2½ - 3h
Flapjack		170-180	1	170-180	25 - 30
Shortbread		130-140	1	140-150	45 - 65
Casseroles:					
Beef/lamb	but ensure	140-160	1 *	140-160	2½ - 3h
Chicken		180-190	1 *	180-190	1¼ - 1½h
Convenience Foods		Follow manufacturer's instructions			
Fish	that oven	170-190	1	170-190	20 - 30
Fish Pie (Potato Topped)		190-200	1 *	190-200	20 - 25
Fruit Pies, Crumbles		190-200	1	190-200	40 - 50
Milk Puddings	shelves are	130-140	1	140-150	1½ - 2h
Pasta, Lasagne etc.		190-200	1	170-180	40 - 45
Pastry:					
Choux		190-200	1	180-190	30 - 35
Eclairs, Profiteroles	evenly	170-180	1	170-180	20 - 30
Flaky/Puff Pies		210-220	1 *	210-220	25 - 40
Shortcrust					
Mince Pies		190-200	1	190-200	15 - 20
Meat Pies	spaced	190-210	1 *	190-210	25 - 35
Quiche, Tarts, Flans		180-210	1	180-200	25 - 45
Patés and Terrines		150-160	1	150-160	1-1½h
Roasting Meat, Poultry	when more	160-180	1 *	160-180	see roasting chart
Scones		210-220	1	220-230	8 - 10
Shepherd's Pie		190-200	1 *	190-200	30 - 40
Soufflés	than one is	170-180	1	170-180	20 - 30
Vegetables:					
Baked Jacket Potatoes		180-190	1	180-190	1-1½h
Roast Potatoes		180-190	1	180-190	1-1½h
Stuffed Marrow	used	180-190	1	180-190	30 - 35
Stuffed Tomatoes		180-190	1	180-190	15 - 20
Yorkshire Puddings: Large		210-220	1	200-210	25 - 40
Individual		200-210	1	200-210	15 - 25

\* or on a straight shelf on the oven base.

Note: Shelf positions are counted from the bottom of the oven.

## DEFROST FEATURE (CSB4431 GOURMET ONLY)

### USES OF DEFROST FEATURE

This fan oven function defrosts most foods faster than more conventional methods. It is particularly suitable for delicate frozen foods which are to be served cold e.g. cream filled gateaux, cakes covered with icings or frostings, cheesecakes, biscuits, scones etc.

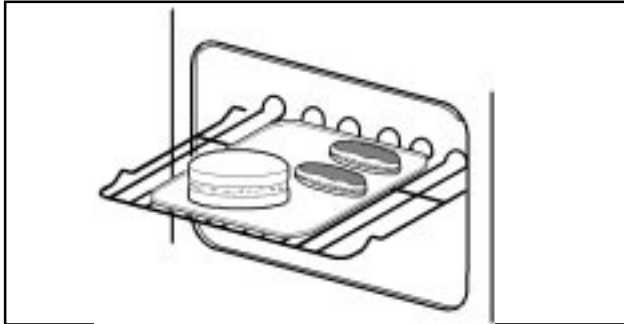

It is preferable to thaw fish, meat and poultry slowly in the fridge. However, this process can be accelerated by using the defrost function.

Small or thin fish fillets, frozen peeled prawns, cubed or minced meat, liver, thin chops, steaks etc., can be thawed in 1 - 2 hours.

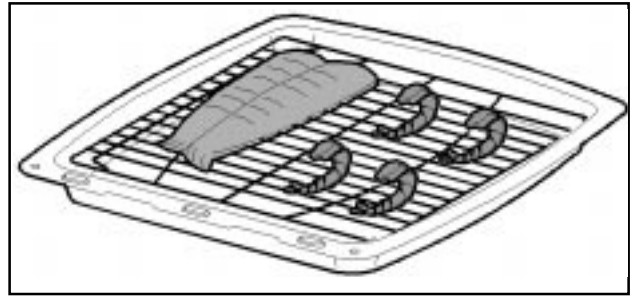

A 1kg/2¼lb oven ready chicken will be thawed in approximately 5 hours. Remove the giblets as soon as possible during the thawing process.

Joints of meat up to 2kg/4½lb in weight can be thawed using the defrost function.

**ALL JOINTS OF MEAT AND POULTRY MUST BE THAWED THOROUGHLY BEFORE COOKING.**

**ALWAYS COOK THOROUGHLY IMMEDIATELY AFTER THAWING.**

### SELECTING DEFROST

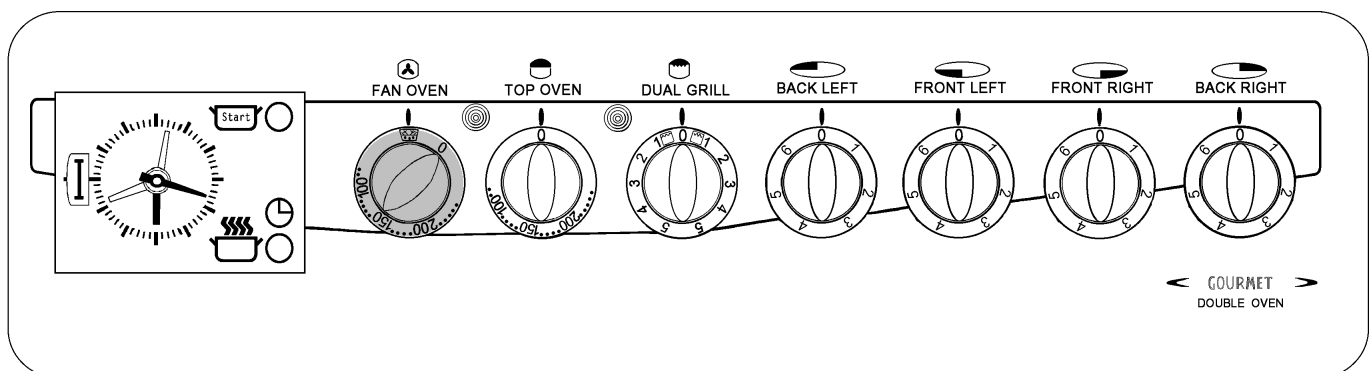

- Turn the main oven temperature control to the defrost setting. ❄️
- When defrost is selected, the oven indicator neon may come ON. It will stay ON until the oven reaches room temperature and then go OFF.
- It may turn ON and OFF periodically during defrosting to maintain a steady room temperature, inside the oven.

### THINGS TO NOTE

Care must always be taken when handling foods in the home. Always follow the basic rules of food hygiene to prevent bacterial and microbial growth and cross contamination when defrosting, preparing, cooking, cooling and freezing foods.

### HINTS AND TIPS

- Place the frozen food in a single layer where possible and turn it over half way through the defrosting process.

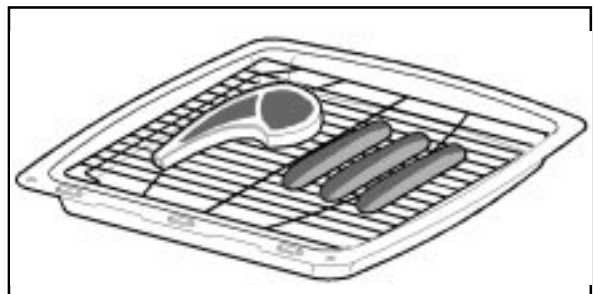

- The actual speed of defrosting is influenced by room temperature. On warm days defrosting will be faster than on cooler days.
- **DO NOT** leave food at room temperature once it is defrosted. Cook raw food immediately or store cooked food in the fridge.

## CARE AND CLEANING

**ALWAYS SWITCH OFF THE ELECTRICITY SUPPLY AND ALLOW THE COOKER TO COOL BEFORE CLEANING**

### CLEANING MATERIALS

Before using any cleaning materials on your cooker, check that they are suitable and that their use is recommended by the manufacturer.

Cleaners that contain bleach should NOT be used as they may dull the surface finishes. Harsh abrasives should also be avoided.

### CLEANING THE SEALED HOTPLATES AND HOTPLATE TRIMS

In order to maintain the appearance of your cooker's sealed hotplates and trims you are advised to use the recommended cleaning agents daily. If you do not allow spillages to burn on they will be much easier to clean off.

### THINGS TO NOTE

The red spot in the centre of the hotplates may be removed with some abrasive cleaning agents. This is not a fault and does not effect the performance of the hotplate.

### FOR NORMAL SOILAGE

Wipe over the hotplates and trims using a clean damp cloth then switch to a low or medium setting for a few minutes to thoroughly dry.

### FOR HEAVY SOILAGE

Use a clean damp cloth or scourer with a cream cleaner e.g. 'Jif' or a powder cleaner e.g. 'Ajax' on the hotplate and trims. Follow the circular grooved pattern on the hotplate when cleaning. Rinse off cleaning agents thoroughly. Dry as for normal soilage.

For more stubborn marks warm the hotplate on a low setting for 30 seconds. Clean the sealed plate with 'Ajax' powder cleaner, 'Jif' cream cleaner or a Brillo pad. You may have to rub hard for several minutes.

Rinse off cleaning agents thoroughly with a damp cloth. Switch to a low or medium setting for a few minutes until the hotplate is thoroughly dry.

### CLEANING THE HOTPLATE TRIMS

The stainless steel trims may become straw coloured during use. Using a proprietary stainless steel cleaner, e.g. 'Shiny Sinks' will help maintain a bright appearance. Alternatively a powder cleaner such as 'Bar Keepers Friend' may be used regularly.

### CLEANING THE VITREOUS ENAMEL

Use a clean damp cloth or scourer made for non-stick saucepans with 'Jif' cream cleaner.

### AFTER CLEANING

To maintain the appearance of the hotplates occasionally apply a little salt free vegetable oil or commercial restorative agent e.g. '4 Hob' or use a 'Minky' Hotplate Cleaning Cloth.

To apply vegetable oil, first heat the hotplate on a medium setting for 30 seconds then turn OFF. Pour a very small amount of oil onto kitchen paper, apply the paper to the hotplate and wipe off any excess oil. Heat the hotplate on a medium setting for 1 minute.

To apply restorative agent, apply a thin coating of '4 Hob' or use a Minky cloth following the manufacturers instructions.

### CLEANING THE OUTSIDE OF THE COOKER

DO NOT use abrasive cleaning materials, or scourers on the outside of the cooker as some of the finishes are painted and damage may occur. Regularly wipe over the control panel, splashback, oven doors and cooker sides using a soft cloth and liquid detergent.

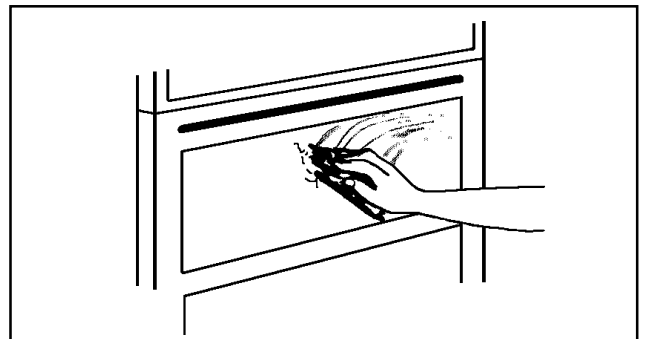

**DO NOT ATTEMPT TO REMOVE ANY OF THE CONTROL KNOBS FROM THE PANEL AS THIS MAY CAUSE DAMAGE AND IS A SAFETY HAZARD**

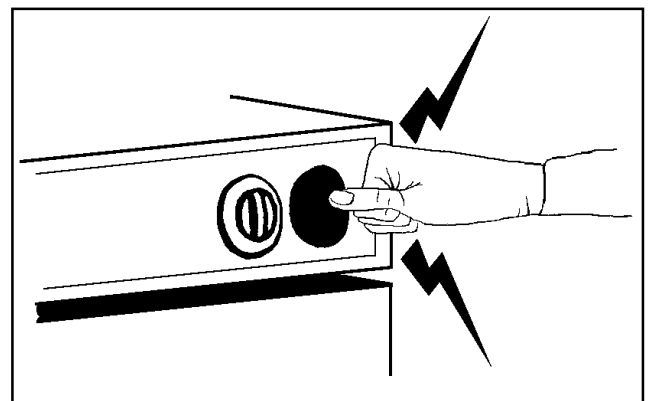

## CLEANING THE GRILL DEFLECTOR, GRILL PAN, GRILL PAN GRID AND OVEN SHELVES

All removable parts can be washed in the dishwasher.

The grill pan and grill deflector can be cleaned using a soap impregnated steel wool pad. The grill pan grid and oven shelves should be cleaned using hot soapy water. Soaking first in soapy water will make cleaning easier.

## CLEANING INSIDE THE OVEN/GRILL COMPARTMENTS

The Stayclean surfaces inside the main oven (CSB4411) and top and main ovens (CSB4431) should not be cleaned manually. See "Care of Stayclean Surfaces".

The vitreous enamel oven base and grill compartment (CSB4411 only) can be cleaned using normal oven cleaners or aerosol oven cleaners with care. Ensure that the manufacturers instructions are followed and that all parts are well rinsed afterwards.

**Aerosol cleaners must not be used on Stayclean surfaces and must not come into contact with elements as this may cause damage.**

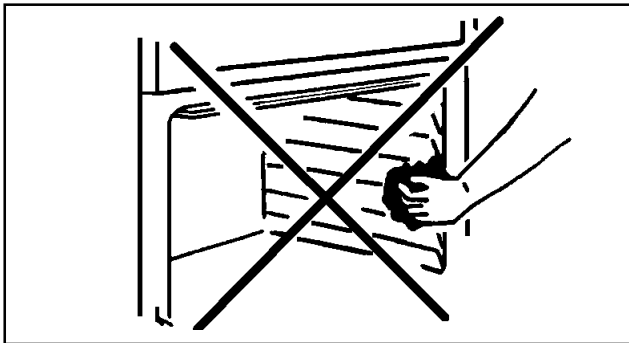

## CARE OF STAYCLEAN SURFACES

Stayclean surfaces destroy splashes of food and fats when the oven temperature is raised to around 220°C.

It is a good idea to run the oven for an hour or two per week to ensure continued good performance from the Stayclean finish.

## HINTS AND TIPS

- Manual cleaning of Stayclean IS NOT recommended. Damage will occur if oven sprays or abrasives of any kind are used.
- Slight discolouration and polishing of the Stayclean surface may occur in time. This does not affect the Stayclean properties in any way.
- A good time to allow the oven to run on is after the weekly roast. After removing the roast, turn the oven up to 220°C and allow to run for an hour or so. It is important NOT to allow a build-up of soilage as this can prevent the Stayclean from working.
- Follow the recommendations below to keep oven soilage to a minimum.
- Cook at the recommended temperatures. Higher temperatures during roasting will increase soilage. Try cooking at lower temperatures for an increased length of time, you will save energy and often the joint is more tender.
- Use minimal, if any, extra oil or fat when roasting meat, potatoes only require brushing with fat before cooking. Extra fat in the oven during roasting will increase splashing and soilage.
- It is NOT necessary to add water to a meat tin when roasting. The water and the fat juices from the joint create excessive splattering during cooking - even at normal temperatures, as well as causing condensation.
- Covering joints during cooking will also prevent splashing onto the interior surfaces. Removing the covering for the last 20-30 minutes will allow extra browning if required. Some large joints and turkeys especially benefit by this method of cooking, allowing the joint to cook through before the outside is over-browned.

## SOMETHING NOT WORKING?

We strongly recommend that you carry out the following checks on your appliance before calling a Service Engineer. It may be that the problem is a simple one, which you can solve yourself without the expense of a service call.

If our Service Engineer finds that the problem is listed below you will be charged for the call whether or not the appliance is under guarantee.

### **The cooker does not work at all:**

- \* Check that the appliance has been wired in and is switched on at the wall.
- \* Check that the main cooker fuse is working.
- \* Check that the timer is set to manual (see page 13).

### **The grill and hotplates work but the oven does not:**

- \* Check that the timer is set to manual operation (see page 13).

### **The oven temperature is too high or low:**

- \* Check that the recommended temperatures are being used (see cooking charts). Be prepared to adjust up or down by 10°C to achieve the results you want.

### **The hotplates and oven work but the grill does not:**

- \* Check that you have carefully followed the instructions for operation of the grill.

### **The oven is not cooking evenly or the side opening door will not stay open:**

- \* Check that the cooker is level.

### **(CSB4431 only)**

### **The oven fan is noisy:**

- \* Check that bakeware is not vibrating in contact with the back panel.
- \* Check that the oven is level.

# SERVICE AND SPARE PARTS



In the event of your appliance requiring service, or if you wish to purchase spare parts please contact your local Tricity Bendix Service Force Centre by telephoning:

**0870 5 929929**

Your call will be routed to the Service Force Centre covering your post code area. The address of your local Service Force Centre is detailed on pages 31 - 32.

For Service in the **Republic of Ireland** contact  
Tricity Bendix  
Long Mile Road  
Dublin 12

Telephone: 01 4090752

Before calling out an engineer, please ensure you have read the details under the heading 'Something Not Working'.

When you contact the Service Centre you will need to give the following details:

1. Your name, address and post code
2. Your telephone number
3. Clear and concise details of the fault
4. The model, product and serial number of the appliance (found on the rating plate)
5. The purchase date

## CUSTOMER CARE DEPARTMENT

For general enquiries concerning your Tricity Bendix appliance, or further information on Tricity Bendix products, you are invited to contact our Customer Care Department by letter or telephone as follows:

Customer Care Department  
Tricity Bendix  
55 - 77 High Street  
Slough  
Berkshire  
SL1 1DZ

Tel: 0870 5 950950 \*

(\*calls to this number may be recorded for training purposes.)

To contact your local Tricity Bendix Service Centre telephone **0870 5929929**

**CHANNEL ISLANDS**

<b>GUERNSEY</b>	Guernsey Electricity PO Box 4 Vale , Guernsey Channel Islands
<b>JERSEY</b>	Jersey Electricity Company PO Box 45 Queens Road St Helier Jersey Channel Islands JE4 8NY

**SCOTLAND**

<b>ABERDEEN (M05)</b>	54 Claremont Street Aberdeen AB10 6RA
<b>AUCHTERMUCHY (M03)</b>	33A Burnside Auchtermuchy Fife KY14 7AJ
<b>BLANTYRE (M07)</b>	Unit 5 Block 2 Auchenraith Ind Estate Rosendale Way Blantyre G72 0NJ
<b>DUMFRIES (M01)</b>	93 Irish Street Dumfries Scotland DG1 2PQ
<b>DUNOON (M67)</b>	Briar Hill 7 Hill Street, Dunoon Argyll PA23 7AL
<b>GLASGOW (M04)</b>	20 Cunningham Road Clyde Estate Rutherglen, Glasgow, G73 1PP
<b>INVERNESS (M06)</b>	Unit 3B Smithton Ind. Estate Smithton Inverness IV1 AJ
<b>ISLE OF ARRAN (OWN SALES)</b>	Arran Domestics Unit 4 The Douglas Centre Brodrick Isle of Arran KA27 8AJ
<b>ISLE OF BARRA (OWN SALES)</b>	J Zerfah 244 Bruernish Isle of Barra Western Islands HS9 5QY
<b>ISLE OF BUTE (M66)</b>	Walker Engineering Glenmhor Upper Serpentine Road Rothsay Isle of Bute PA20 9EH
<b>ISLE OF LEWIS (M69)</b>	ND Macleod 16 James Street Stornoway Isle of Lewis PA87 2QW
<b>KELSO (M08)</b>	2-8 Wood Market Kelso Borders TD5 7AX

<b>ORKNEY (M65)</b>	Corsie Domestics 7 King Street Kirkwall Orkney KW15
<b>PERTH</b>	Hydro Electric Inveralmond House Ruthvenfield Road Perth PH1 3AQ
<b>PERTH</b>	Graham Begg Unit 4 Airport Ind. Estate Wick KW1 4QS
<b>(OWN SALES)</b>	
<b>SHETLAND</b>	Tait Electronic Systems Ltd. Holmsgarth Road Lerwick Shetland ZE1 0PW
<b>(OWN SALES)</b>	
<b>SHETLAND</b>	Bolts Shetland Ltd 26 North Road Lerwick Shetland ZE1 0PE
<b>(OWN SALES)</b>	
<b>WHALSAY</b>	Leask Electrical Harlsdale Symbister, Whalsay Shetland ZE2 9AA
<b>(OWN SALES)</b>	

**NORTHERN IRELAND**

<b>BELFAST (M27)</b>	Owenmore House Kilwee Business Park Upper Dunmury Lane Belfast BT17 0HD
----------------------	---

**WALES**

<b>CARDIFF (M28)</b>	Guardia Industrial Estate Clydesmuir Road Tremorfa, Cardiff CF2 2QS
<b>CLYWD (M14)</b>	Unit 6-7 Coed - Parc Abergele Road Rhuddlan Clwyd Wales LL18 5UG
<b>DYFED (M77)</b>	Maes Y Coen High Mead Llanybydder Carmathenshire SA40 9UL
<b>HAVERFORDWEST (M75)</b>	Cromlech Lodge Ameriston Haverfordwest Pembrokeshire SA62 5DS
<b>OSWESTRY (M17)</b>	Plas Ffynnon Warehouse Middleton Road Oswestry SY11 2PP

**NORTH EAST**

<b>GATESHEAD (M39)</b>	Unit 356a Dukesway Court Dukesway Team Valley Gateshead NE11 0BH
<b>GRIMSBY (M42)</b>	15 Hainton Avenue Grimsby South Humberside DN32 9AS
<b>HULL (M41)</b>	Unit 1 Boulevard Industrial Estate Hull HU3 4AY
<b>LEEDS (M37)</b>	64-66 Cross Gates Road Leeds LS15 7NN
<b>NEWTON AYCLIFFE (M45)</b>	Unit 16 Gurney Way Aycliffe Industrial Estate Newton Aycliffe DL5 6UJ
<b>SHEFFIELD (M38)</b>	Pennine House Roman Ridge Ind. Roman Ridge Road Sheffield S9 1GB

**NORTH WEST**

<b>BIRKENHEAD (M11)</b>	1 Kelvin Park Dock Road Birkenhead L41 1LT
<b>CARLISLE (M10)</b>	Unit 7 James Street Workshops James Street Carlisle Cumbria CA2 5AH
<b>ISLE OF MAN (M64)</b>	South Quay Ind. Estate Douglas Isle of Man IM1 5AT
<b>LIVERPOOL (M15)</b>	Unit 1 Honeys Green Precinct Honeys Green Lane Liverpool L12 9JH
<b>MANCHESTER (M09)</b>	Unit B Central Industrial Estate St Marks Street Bolton BL3 6NR
<b>PRESTON (M13)</b>	Unit 250 Dawson Place Walton Summit Bamber Bridge Preston Lancashire PR5 8AL
<b>STOCKPORT (M16)</b>	Unit 20 Haigh Park Haigh Avenue Stockport SK4 1QR

To contact your local Tricity Bendix Service Centre telephone **0870 5 929929**

### MIDLANDS

BIRMINGHAM (M18)	66 Birch Road East, Wyrley Road Ind. Estate Witton Birmingham B6 7DB
BOURNE (M44)	Manning Road Ind Estate Pinfold Road Bourne PE10 9HT
BRIDGNORTH (M72)	68 St. Mary's Street Bridgnorth Stropshire WV16 4DR
GLOUCESTER (M23)	101 Rycroft Street Gloucester GL1 4NB
HEREFORD (M31)	Unit 3 Bank Buildings Cattle Market Hereford HE4 9HX
HIGHAM FERRERS (M51)	30 High Street Higham Ferrers Northants NN10 8BB
ILKESTON (M43)	Unit 2 Furnace Road Ilkeston DE7 5EP
LEICESTER (M22)	Unit 7 Oaks Industrial Estate Coventry Road Narborough Leicestershire LE0 5GF
LINCOLN (M40)	Unit 8 Stonefield Park Clifton Street Lincoln LN5 8AA
NEWCASTLE UNDER LYME (M12)	18-21 Croft Road Brampton Ind. Estate Newcastle under Lyme Staffordshire ST5 0TW
REDDITCH (M20)	13 Thornhill Road North Moons Moat Redditch Worcestershire B98 9ND
TAMWORTH (M19)	Unit 3 Sterling Park Claymore Tamworth B77 5DO
WORCESTER (M73)	Unit 1&2 Northbrook Close Gregorys Mill Ind. Estate Worcester WR3 8BP

### LONDON & EAST ANGLIA

BECKENHAM (M79)	11a Gardener Ind. Estate Kent House Lane Beckenham Kent BR3 1QZ
CHELMSFORD (M47)	Hanbury Road Widford Ind Estate Chelmsford Essex CM12 3AE
COLINDALE (M53)	Unit 14 Capitol Park Capitol Way Colindale London NW9 0EQ
ELTHAM (M78)	194 Court Road Mottingham Eltham London SE9 4EW
ENFIELD (M49)	284 Alma Road Enfield London EN3 7BB
GRAVESEND (M57)	Unit B4, Imperial Business Estate Gravesend Kent DA11 0DL
HARPENDEN (M46)	Unit 4 Riverside Estate Coldharbour Lane Harpenden AL5 4UN
LETCHEWORTH (M50)	16-17 Woodside Ind Est. Works Road Letchworth Herts SG6 1LA
LONDON (M76)	2/4 Royal Lane Yiewsley West Drayton Middlesex UB7 8DL
MAIDENHEAD (M60)	Reform Road Maidenhead Berkshire SL6 8BY
MOLESEY (M61)	10 Island Farm Avenue West Molesey Surrey KT8 2UZ
NEWBURY (M24)	9 Pipers Court Berkshire Drive Thatcham Berkshire RG19 4ER
IPSWICH (M48)	Unit 6C EltonParkBusiness Centre Hadleigh Road Ipswich IP2 0DD
NORWICH (M52)	2b Trafalgar Street Norwich NR1 3HN
SUNBURY (M63)	Unit 1a The Summit Hanworth Road Hanworth Ind Estate Sunbury on Thames TW16 5D

### SOUTH EAST

ASHFORD (M58)	Unit 2 BridgeRoadBusinessEst Bridge Road Ashford Kent TN2 1BB
FLEET (M59)	Unit 1 Redfields Ind. Estate Church Crookham Fleet Hampshire GU13 0RD
HAYWARDS HEATH (M55)	21-25 Bridge Road Haywards Heath Sussex RH16 1UA

### SOUTH WEST

BARNSTAPLE (M30)	Main Road Fremington Barnstaple North Devon EX31 2NT
BOURNEMOUTH (M26)	63-65 Curzon Road Bournemouth Dorset BH1 4PW
BRIDGEWATER (M35)	6 Hamp Ind. Estate Bridgewater Somerset TA6 3NT
BRISTOL (M25)	11 Eldon Way Eldonwall Trading Bristol Avon BS4 3QQ
EMSWORTH (M33)	266 Main Road Southbourne Emsworth PO10 8JL
ISLE OF WIGHT (M34)	Unit 8 Enterprise Court Ryde Business Park Ryde Isle of Wight PO33 1DB
NEWTON ABBOT (M29)	Unit 2 Zealley Ind. Estate Kingsteignton Newton Abbot S. Devon TQ12 3TD
REDRUTH (M36)	Unit 7D Pool Ind. Estate Wilson Way Redruth Cornwall TR15 3QW



## GUARANTEE CONDITIONS

### Standard guarantee conditions

We, Tricity Bendix, undertake that if within 12 months of the date of the purchase this Tricity Bendix appliance or any part thereof is proved to be defective by reason only of faulty workmanship or materials, we will, at our option repair or replace the same FREE OF CHARGE for labour, materials or carriage on condition that:

- The appliance has been correctly installed and used only on the electricity supply stated on the rating plate.
- The appliance has been used for normal domestic purposes only, and in accordance with the manufacturer's instructions.
- The appliance has not been serviced, maintained, repaired, taken apart or tampered with by any person not authorised by us.
- All service work under this guarantee must be undertaken by a Tricity Bendix service centre.
- Any appliance or defective part replaced shall become the Company's property.
- This guarantee is in addition to your statutory and other legal rights.

Home visits are made between **8.30am** and **5.30pm** Monday to Friday. Visits may be available outside these hours in which case a **premium** will be charged.

### Exclusions

#### This guarantee does not cover:

- Damage or calls resulting from transportation, improper use or neglect, the replacement of any light bulbs or removable parts of glass or plastic.
- Costs incurred for calls to put right an appliance which is improperly installed or calls to appliances outside the United Kingdom.
- Appliances found to be in use within a commercial environment, plus those which are subject to rental agreements.
- Products of Tricity Bendix manufacture which are not marketed by Tricity Bendix.

### European Guarantee

If you should move to another country within Europe then your guarantee moves with you to your new home subject to the following qualifications:

- The guarantee starts from the date you first purchased your product.
- The guarantee is for the same period and to the same extent for labour and parts as exists in the new country of use for this brand or range of products.
- This guarantee relates to you and cannot be transferred to another user.
- Your new home is within the European Community (EC) or European Free Trade Area.
- The product is installed and used in accordance with our instructions and is only used domestically, i.e. a normal household.
- The product is installed taking into account regulations in your new country.

Before you move please contact your nearest Customer Care centre, listed below, to give them details of your new home. They will then ensure that the local Service Organisation is aware of your move and able to look after you and your appliances.

France	Senlis	+33 (0)3 44 62 28 28
Germany	Nürnberg	+49 (0)911 323 2600
Italy	Pordenone	+39 (0)1678 47053
Sweden	Stockholm	+46 (0)20 78 77 50
UK	Slough	+44 (0)1753 219 898





## RATING PLATE REFERENCE

MAKE AND MODEL NO.	PRODUCT NO.	SERIAL NO.	DATE OF PURCHASE

### IMPORTANT NOTICE

In line with our continuing policy of research and development, we reserve the right to alter models and specifications without prior notice.

This handbook is accurate at the date of printing, but will be superseded and should be disregarded if specifications or appearance are changed.



TRICITY BENDIX, 55 - 77 HIGH STREET, SLOUGH, BERKSHIRE, SL1 1DZ  
TELEPHONE 0870 5 950950

MODEL NO.  
**CSB4411 / CSB4431**



PART NO.  
**311341308**

© Electrolux Household Appliances Limited 2000

 **From the Electrolux Group.** *The world's No. 1 choice.*

The Electrolux Group is the world's largest producer of powered appliances for kitchen, cleaning and outdoor use. More than 55 million Electrolux group products (such as refrigerators, cookers, washing machines, vacuum cleaners, chain saws and lawn mowers) are sold each year to a value of approx. USD 14 billion in more than 150 countries around the world.

Download from [www.Somanuals.com](http://www.Somanuals.com). All Manuals Search And Download.

## Free Manuals Download Website

<http://myh66.com>

<http://usermanuals.us>

<http://www.somanuals.com>

<http://www.4manuals.cc>

<http://www.manual-lib.com>

<http://www.404manual.com>

<http://www.luxmanual.com>

<http://aubethermostatmanual.com>

Golf course search by state

<http://golfingnear.com>

Email search by domain

<http://emailbydomain.com>

Auto manuals search

<http://auto.somanuals.com>

TV manuals search

<http://tv.somanuals.com>