

TRICITY BENDIX

Better Products. Better Value.



OPERATING AND INSTALLATION INSTRUCTIONS

MODEL NO.
SI 452

TECHNICAL DETAILS

MODEL NO. SI 452

Voltage: 230/240 Volts AC 50Hz

Wattage: 10.3/11.2 kW

Height: 900mm

Width: 550mm

Depth: 600mm

This appliance complies with: European Council Directive 73/23/EEC.
EMC Directive 89/336/EEC.
CE Marking Directive 93/68/EEC.

CONTENTS

Technical Details	2
Contents	3
Preface	5
Safety	6
Before Installation	6
During Operation	6
After Use	7
General	7
Introduction	8
Rating Plate	8
Installation	8
Reversible Main Oven Door	9
General Notes on using your Cooker	9
About Condensation and Steam	9
Push to Turn Controls	9
The Cooling Fan for the Controls	9
Grill and Oven Furniture	9
Getting to Know Your Cooker	10
The Control Panel	10
The Programmer	11
The Ceramic Hob	15
Recommended Saucepans	15
Hints and Tips	15
Deep Fat Frying	16
Preserving	16
The Dual Grill	17
Uses of the Grill	17
Selecting the Grill	17
Things to Note	17
The Grill Pan and Handle	17
Hints and Tips	18
Grilling Chart	18
The Top Oven	19
Uses of the Top Oven	19
Selecting the Top Oven	19
Things to Note	19
To Fit the Top Oven Shelf	19
Hints and Tips	20
Automatic Cooking	20
The Main Fan Oven	21
Uses of the Fan Oven	21
Selecting the Fan Oven	21
Things to Note	21
To Fit the Main Oven Shelves	22
Hints and Tips	22
Automatic Cooking	22

CONTENTS

Oven Cooking Chart	23
Roasting Chart	24
Defrost Feature	25
Uses of Defrost Feature	25
Selecting Defrost	25
Things to Note	25
Hints and Tips	25
Care and Cleaning	26
Cleaning Materials	26
Cleaning the Ceramic Hob	26
Cleaning the Outside of the Cooker	28
Cleaning the Grill Deflector, Grill Pan, Grill Pan Grid, Meat Tin and Oven Shelves	28
Cleaning Inside the Grill/Oven Compartments	28
Care of Stayclean Surfaces	28
Hints and Tips	28
Cleaning Between the Outer and Inner Door Glass	29
Replacing the Oven Light Bulb	29
Something not Working?	30
Service and Spare Parts	31
Customer Service Centres	32
Guarantee Conditions	36

PREFACE

Dear Customer,

Thank you for buying a Tricity Bendix cooker. With our 80 years experience in developing and manufacturing the very best in U.K. cookers, you can be assured that you have purchased a hard working, reliable, quality product.

Tricity Bendix cookers comply with British Standard safety and performance requirements. They have been approved by BEAB (British Electrotechnical Approvals Board) and are covered by a 12 month parts and labour guarantee.

To get the best from your new Tricity Bendix cooker, we ask that you PLEASE READ THESE INSTRUCTIONS CAREFULLY. Particular attention should be made to cooking times and temperatures which may differ from your previous cooker.

It is most important that this instruction book is retained with the appliance for future reference. Should the appliance be sold, or if you move house and leave the appliance, always ensure that the book remains with the appliance. This will enable the new owner to be acquainted with the functioning of the appliance and the relevant warnings.

Please read the whole instruction book before attempting to use the appliance ensuring you follow the recommendations given.

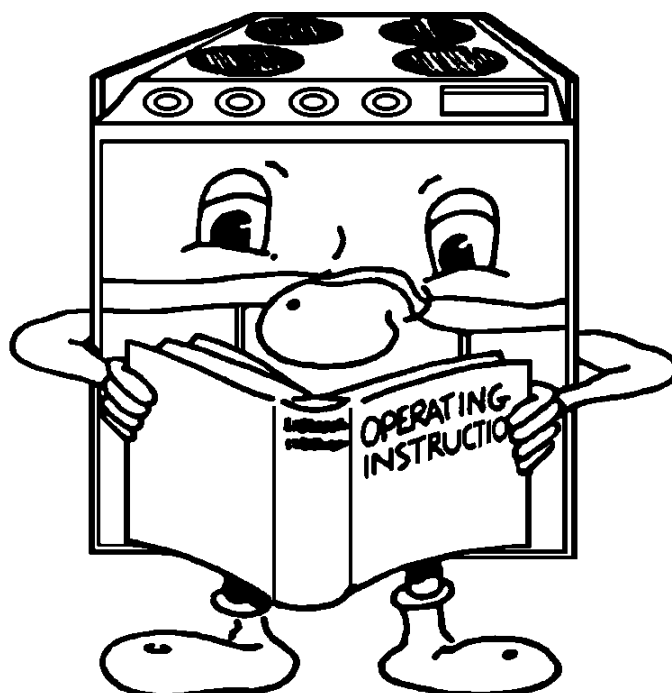

SAFETY

THESE WARNINGS ARE PROVIDED IN THE INTERESTS OF YOUR SAFETY. ENSURE THAT YOU UNDERSTAND THEM ALL BEFORE INSTALLING OR USING THE COOKER.

PLEASE
READ
CAREFULLY



BEFORE INSTALLATION



This appliance is heavy and care **must** be taken when moving it.



Ensure that all packaging, both inside and outside the appliance, has been removed before the appliance is used.



Do not try to move the appliance by pulling the door handles.

The electrical installation work **must** be undertaken by a qualified electrician/competent person.



It is dangerous to alter or modify the specifications of the product in any way.

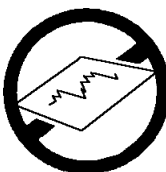

Do not use the cooker if the ceramic glass is damaged. If a fault or crack becomes visible during cooking, disconnect the cooker immediately from the electricity supply and contact the Customer Service Centre.

Do not place silver foil or plastic containers on ceramic glass.



After installation, please dispose of the packaging with due regard to safety and the environment.

DURING OPERATION



Do not use this appliance if it is in contact with water. **Never** operate it with wet hands.



This appliance is designed to be operated by adults. Young children **must not** be allowed to tamper with the product or play with the controls.

Accessible parts especially around the grill area may become hot when the appliance is in use. Children should be **kept away** until it has cooled.



Take **great care** when heating fats and oils as they will ignite if they become too hot.

This product has been designed for cooking edible foodstuffs only, and **must not** be used for any other purposes.



Never place plastic or any other material which may melt in the oven or on the hob.



Ensure cooking utensils are large enough to contain foods to prevent spillages and boil overs.

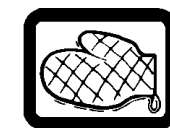

The handles of saucepans which are smaller than the heated area on the hob will become hot. **Ensure** your hand is protected before handling the pan.



Take care to follow the recommendations given for tending the food when grilling.



Do not leave the handle in position when grilling as it will become hot.



Always use oven gloves to remove and replace food in the oven. Similarly always use oven gloves to remove and replace the grill pan handle when grilling. Recommendations given on page 17.



Ensure that you support the grill pan when it is in the withdrawn or partially withdrawn position.

Ensure that all vents are left unobstructed to ensure ventilation of the oven cavity.

Ensure that the anti-tilt shelves are put in place correctly. Refer to instructions on page 19 and 22.

Never line any part of the appliance with aluminium foil.



Always stand back from the appliance when opening the oven door to allow any build up of steam or heat to release.



Do not place sealed cans or aerosols inside the oven. They may explode if they are heated.

Do not leave the hotplates switched on for long periods when not covered by a saucepan. The controls may overheat.

AFTER USE



Ensure that all control knobs are in the OFF position when not in use.



For hygiene and safety reasons this appliance should be kept clean at all times. A build-up of fats or other foodstuffs could result in a fire, especially in the grill pan.



Do not leave utensils containing foodstuffs, e.g. fat or oil in or on the appliance in case it is inadvertently switched ON.

Cookers and hobs become **very hot**, and retain their heat for a long period of time after use. Children should be kept well away from the appliance until it has cooled.

GENERAL



Under no circumstances should repairs be carried out by inexperienced persons as this may cause injury or serious malfunction. This product should be serviced by an authorised Service Engineer and only genuine approved spare parts should be used. Details of servicing and repair arrangements are given on page 31 of this book.



Do not stand on the appliance or on the open oven door.



Do not hang towels, dishcloths or clothes from the appliance or its handle. They are a safety hazard.

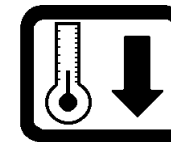

Always allow the cooling fan to cool the cooker down before switching off at the wall prior to carrying out any cleaning or maintenance work.



Only clean this appliance in accordance with the instructions given in this book.

Your safety is of paramount importance.

Therefore, if you are unsure about any of the meanings of these WARNINGS contact the:

Consumer Care Department
Telephone (01582) 585858

INTRODUCTION

WARNING: THIS APPLIANCE MUST BE EARTHED

RATING PLATE

Record the model and serial numbers on the back cover of this instruction book, from the rating plate. This is situated on the lower front frame of the appliance and can be seen upon opening the oven door.

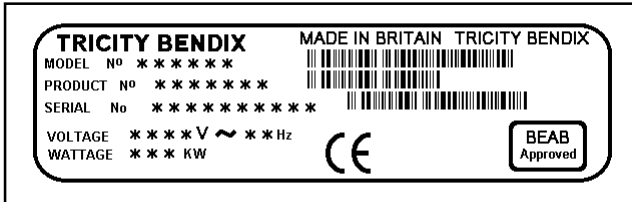

The appliance must be protected by a suitably rated fuse or circuit breaker. The rating of the appliance is given on the rating plate.

INSTALLATION

If your cooker has been damaged in transit, contact your supplier immediately. **DO NOT** attempt to install it.

Your cooker left the factory fully packaged to protect it from damage. If it is delivered without packaging and damage has occurred, the manufacturer cannot accept responsibility. Contact your supplier for advice.

Once the packaging has been removed the cooker should only be moved by hand. **DO NOT** use a sack barrow or any other aid to lift the cooker as damage may occur.

Connection to the electricity supply must be carried out by a qualified electrician/competent person.

The electrical connection should be made using a double pole isolating switch (cooker socket) with at least 3mm contact separation. The cable must have conductors of sufficiently high cross-sectional area to prevent overheating and deterioration.

Six square millimetres (6.00mm²) is the recommended cross-section area.

The cable should be routed away from potentially hot areas marked by X in the diagram below.

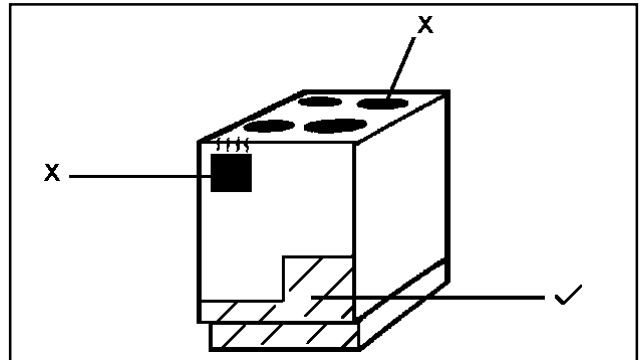

To move the cooker, open the main oven door and lift the cooker by holding inside the top of the compartment.

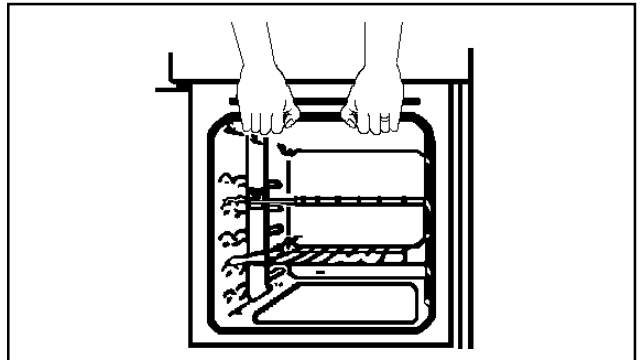

This is a type Y appliance which means it is free-standing and can be fitted with cabinets on one or both sides. It may also be fitted in a corner setting.

Side walls which are above hob level should be protected by heat resistant non-combustible material and **MUST NOT** be nearer than 40mm to the hob side.

A nominal air gap of 2mm all around the cooker is required to enable the cooker to be moved into position.

A spacer has been incorporated into the back of the appliance to ensure an air gap of 10mm is maintained at hotplate level. Tiles or other forms of deep wall covering should not obscure this gap.

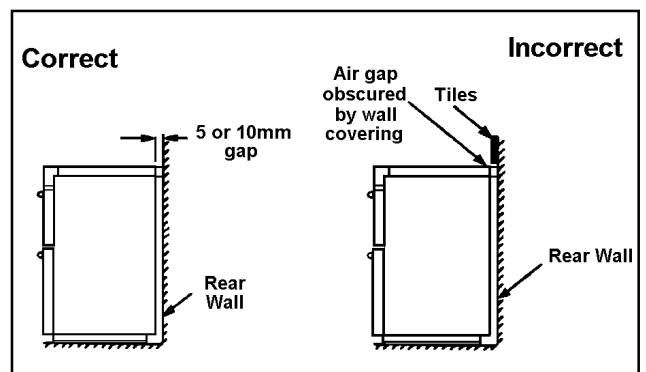

Overhanging surfaces or a cooker hood should be a minimum of 685mm above the hob.

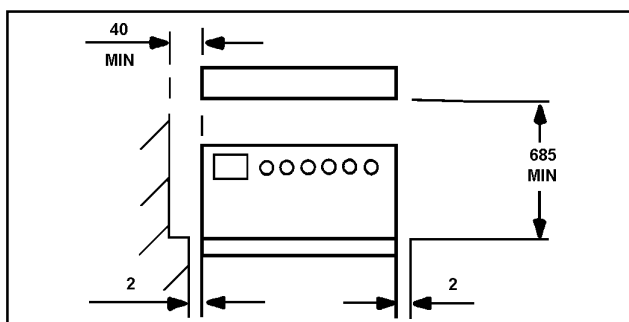

It is important to ensure that the appliance is level after installation. Levelling feet are fitted to the front of the appliance to accommodate uneven floors.

REVERSIBLE MAIN OVEN DOOR

If you require the oven door to be hinged on the opposite side, you will need to contact a qualified Service Engineer. See page 32 for your nearest Service Centre. PLEASE NOTE that a charge will be made.

GENERAL NOTES ON USING YOUR COOKER

We suggest that you run all the elements for a short period to burn off any residue from their surfaces.

During this period an unpleasant odour may be emitted, it is therefore advisable to open a window for ventilation.

ABOUT CONDENSATION AND STEAM

When food is heated it produces steam similar to a boiling kettle. The ovens are vented to allow some of this steam to escape. However, always stand back from the appliance when opening the oven door to allow any build up of steam or heat to release.

If the steam comes into contact with a cool surface on the outside of the appliance, e.g. a trim, it will condense and produce water droplets. This is quite normal and is not caused by a fault on the appliance.

To prevent discolouration, regularly wipe away condensation and also soilage from surfaces.

For your safety wallcoverings at the rear of the appliance should be securely fixed to the wall.

PUSH TO TURN CONTROLS

The control knobs must be pushed in towards the panel before they can be turned or adjusted.

THE COOLING FAN FOR THE CONTROLS

The cooling fan comes on immediately when the grill or top oven are switched on and after a time when the main fan oven is in use. The operation of the cooling fan is temperature dependent in the case of the main oven and the cooling fan may not switch in at all at low temperature settings or where the main oven has only been used for a short time.

The cooling fan may run on after the control knobs have been switched off until the cooker has cooled.

If an automatic programme has been set the cooling fan does not come on until the cooktime begins.

Do not switch the cooker off at its power point until the cooling fan has cooled the cooker down.

GRILL AND OVEN FURNITURE

The following items of oven furniture have been supplied with the cooker:

1 grill pan



1 grill pan handle

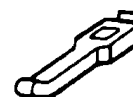

1 grill pan grid

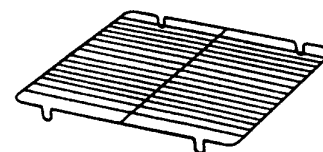

1 grill deflector



1 meat tin



1 trivet

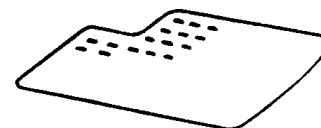

1 cranked shelf for grilling and top oven cooking only

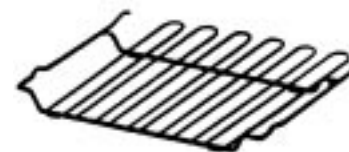

3 straight shelves for main oven cooking

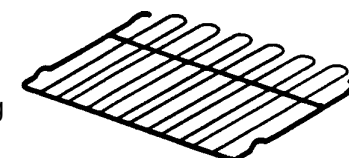

GETTING TO KNOW YOUR COOKER

THE CONTROL PANEL

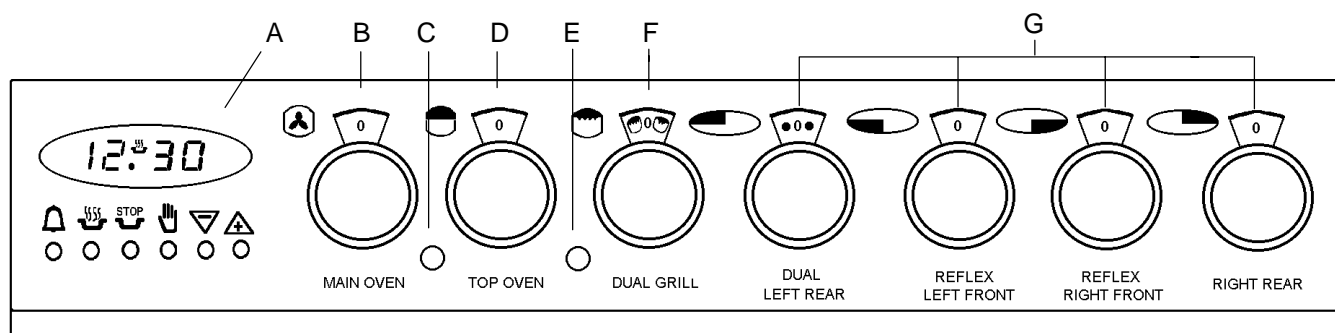

FEATURES

- A - Programmer
- B - Main Oven Temperature Control
- C - Main Oven Indicator Neon
- D - Top Oven Temperature Control
- E - Top Oven Indicator Neon
- F - Dual Grill Control
- G - Hotplate Controls

THE PROGRAMMER

KEY

- A AUTO DISPLAY
- B MINUTE MINDER BUTTON
- C COOKING HOURS BUTTON
- D STOP TIME BUTTON
- E COOKING SYMBOL
- F MANUAL SELECTOR BUTTON
- G DECREASE CONTROL
- H INCREASE CONTROL

NOTE:

STEP 1 BELOW MUST BE FOLLOWED BEFORE THE OVEN WILL OPERATE MANUALLY.

1. SET THE TIME OF DAY

When the electricity supply is first switched ON, the display will flash both 0.00 and AUTO. See Fig. 1.

Press the two buttons marked (☺) and (STOP) press the increase control button (+) and, if necessary, the decrease control button (-) until the correct time on the 24 hour clock is reached, e.g. 10.00am as Fig. 2.

Note: The increase and decrease control buttons operate slowly at first, and then more rapidly. They should be pressed separately.

The AUTO symbol will go out when the correct time of day is set. See Fig. 2.

2. THE MINUTE MINDER

The minute minder gives an audible reminder at the end of any period of cooking up to 23 hrs 59 mins. It is not part of the automatic control.

To set, press the minute minder button (🔔) and the digital display will read 0.00 and the bell symbol will glow as Fig. 3.

Press the increase control (+) until the display indicates the interval to be timed, e.g. 1 hr 45 mins as Fig. 4.

NOTE: This must be completed within 4 seconds of first pressing the minute minder button.

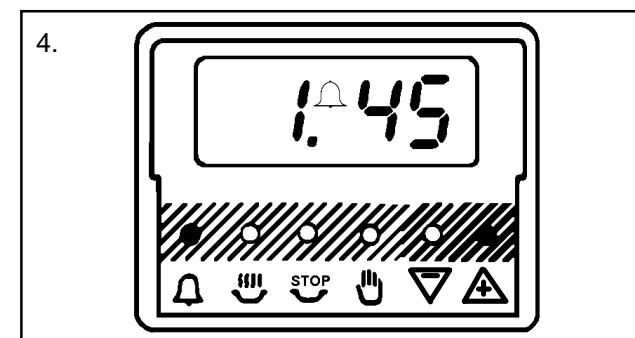
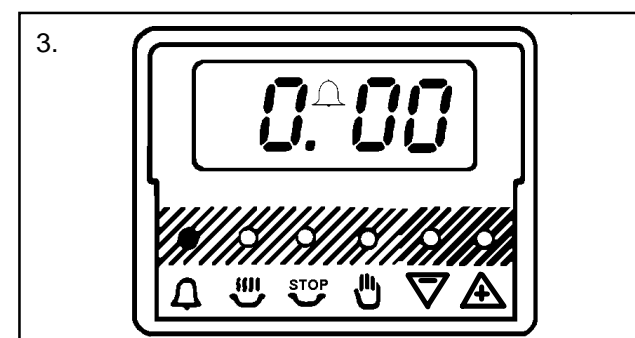
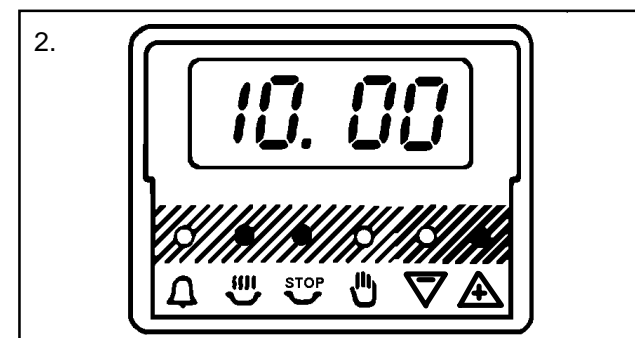
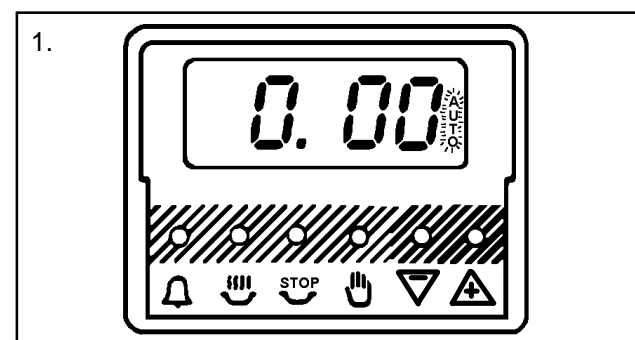
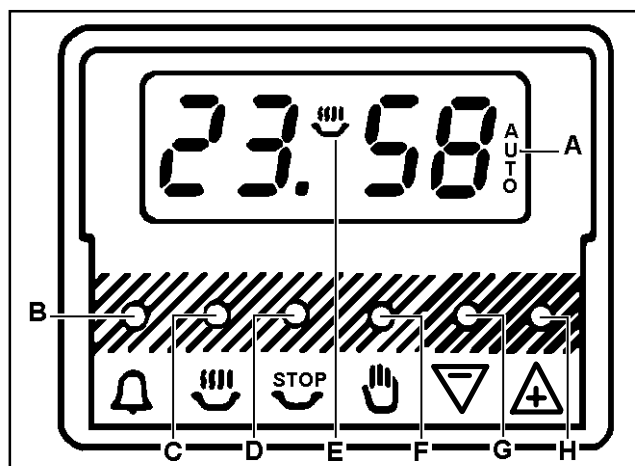

Release the minute minder button and the display will return to the time of day after 5 seconds.

During the operation of the minute minder, the remaining time period can be shown in the display by pressing the minute minder button (🔔). See Fig. 5.

The minute minder will sound intermittently, for up to 2 minutes and the bell symbol will flash at the end of the timed period. The sound can be stopped by pressing any of the 4 left hand side buttons.

3. HOW TO SET THE OVEN TIMER CONTROL

When using the timer control for the very first time, it is advisable to let it operate while you are at home. The displays can be checked to show that it is operating correctly and you will then feel confident to leave a meal to cook automatically in the future.

A) TO SET THE TIMER TO SWITCH ON AND OFF AUTOMATICALLY

- i) Ensure the electricity supply is switched ON and that the correct time of day is displayed, e.g. 9 a.m. as Fig. 6.
- ii) Place food in oven.
- iii) To set the Length of Cooking Time, press the cooking hours button (🕒) press the increase control (+) until the cooking time is displayed, e.g. 2 hrs 15 mins. Fig. 7.
- iv) Release the buttons. The AUTO display and cooking symbols will glow.

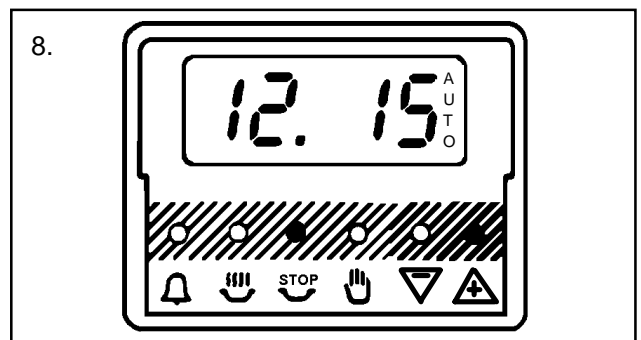
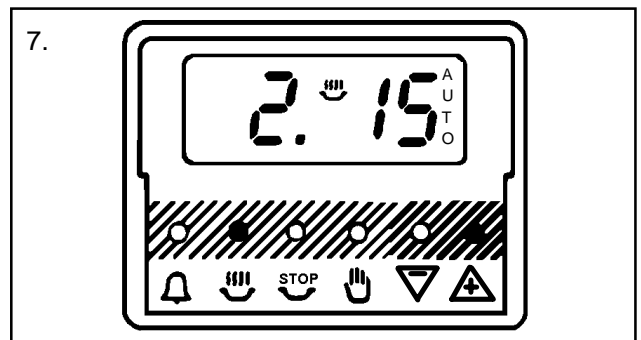
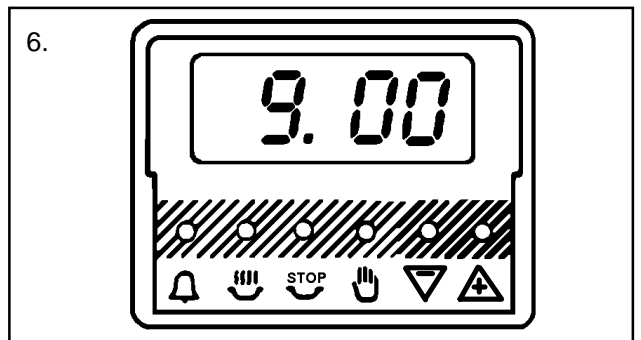
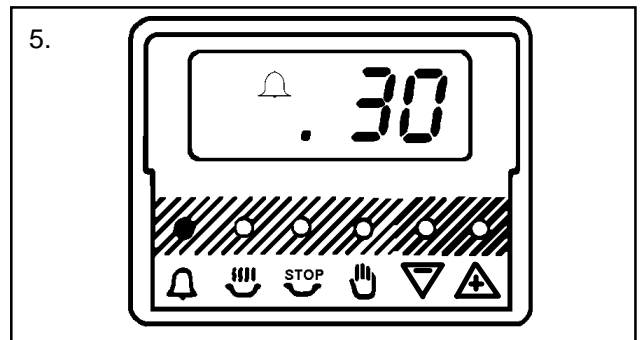

Remember, this must be completed within 4 seconds of first pressing the cooking hours button.

- v) Set the STOP time. Press the stop time button (🛑) press the increase control (+), until the required stop time is displayed, e.g. 12.15 p.m. Fig. 8.
- vi) Release the buttons. The cooking symbol will go out and the time of day will be displayed after 5 seconds.
- vii) Set the oven control to the required temperature. The oven indicator neon should be OFF and the AUTO display will glow.



Note: When the automatic timed period starts, the oven neon will cycle ON and OFF during cooking.

B) TO SET THE TIMER TO SWITCH OFF ONLY

- i) Ensure the electricity supply is switched ON and that the correct time of day is displayed, e.g. 10.00 am. Fig. 9.
- ii) Place food in oven.
- iii) To set the Length of Cooking Time, press the cooking hours button () press the increase control (+) until the cooking time is displayed, e.g. 2 hrs 15 mins. Fig. 10.
- iv) Release the buttons. The AUTO display will glow and the time of day will be displayed after 5 seconds.
- v) Set the oven temperature. The oven indicator neon should come on.
- vi) To check the stop time during the cooking period, simply press the stop time button () and the stop time will be displayed. Fig. 11.

4. RETURNING THE COOKER TO OR TO CANCEL AN AUTOMATIC PROGRAMME

At the end of a timed cooking period, the AUTO light will flash and a bleeper will sound for up to 2 mins. This can be stopped by pressing any of the 4 left hand side buttons. Fig. 12.

Turn the oven temperature control to the OFF position. The AUTO display will continue to flash.

Press () button. The AUTO display will go out. Fig. 13.

Turn the oven control ON to check that the oven operates manually. The oven indicator neon will glow.

Turn all oven controls OFF. No indicator neon should be illuminated.

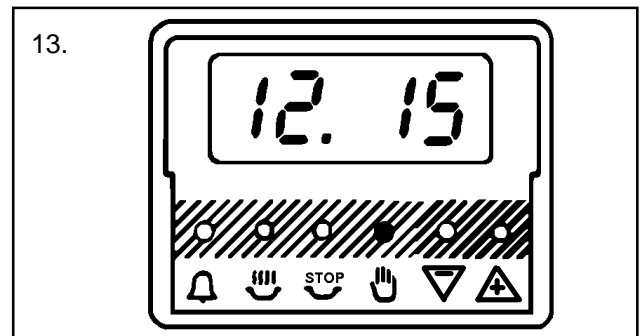
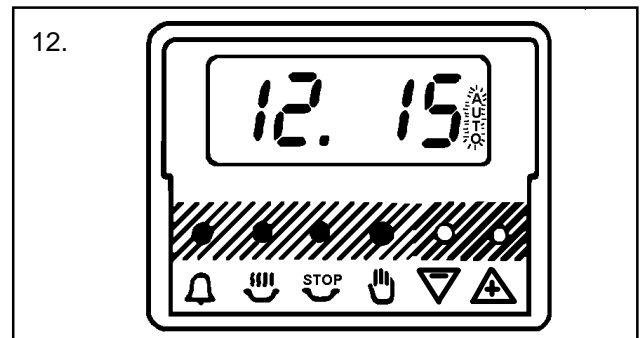
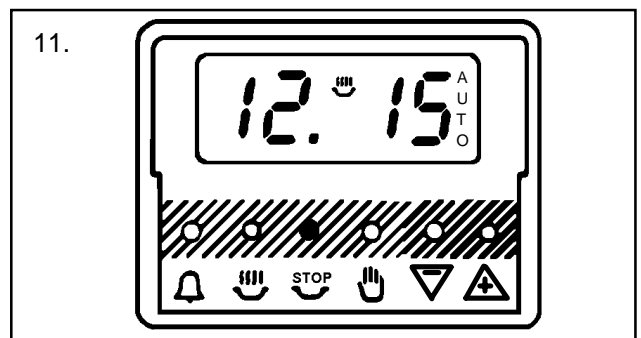
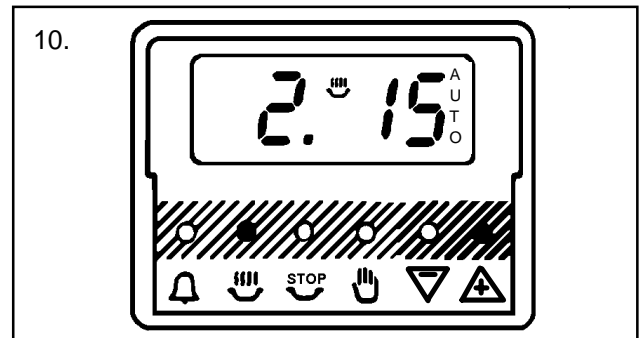
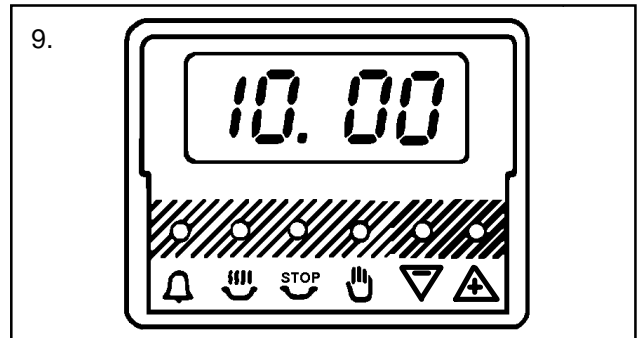

5. THINGS TO NOTE

- * The time of day cannot be altered whilst the AUTO symbol is lit.
- * A programme may be cancelled by returning the cooking hours to zero. Press the cooking hours button (👉👉👉👉) depress (-) button until 0.00 is displayed. Fig. 14.
- * Release all buttons. The AUTO display will now flash and acts as a reminder to reset the appliance to manual.
- * See pages 20 and 22 for advice on automatic cooking.

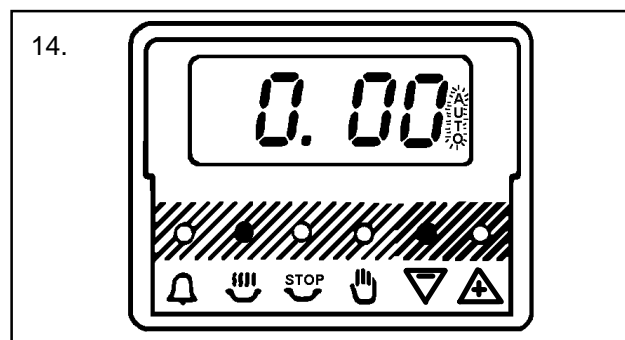

THE CERAMIC HOB

CAUTION: DO NOT USE THE APPLIANCE IF THE CERAMIC GLASS IS DAMAGED. IF A FAULT OR CRACK BECOMES VISIBLE DURING COOKING, DISCONNECT THE APPLIANCE IMMEDIATELY FROM THE ELECTRICITY SUPPLY AND CONTACT THE CUSTOMER SERVICE CENTRE.

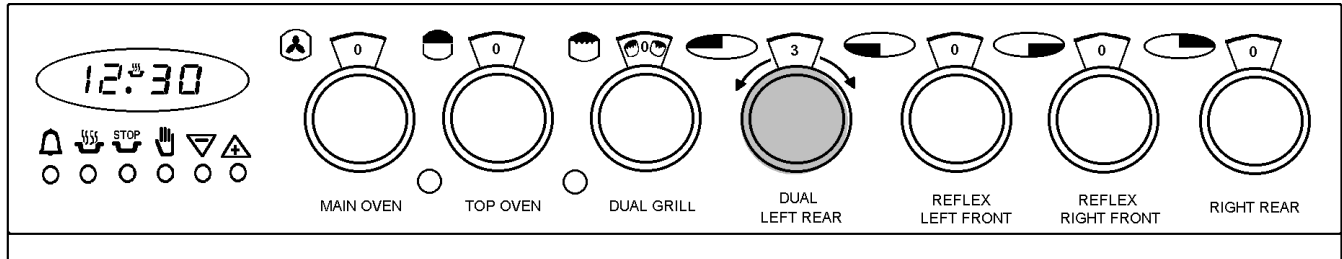

- To operate the dual hotplate, turn the control knob clockwise for the full area or anti-clockwise for the centre section.
- The inner section is very economical when cooking with small diameter saucepans.
- For single hotplates, turn the control knob in either direction to vary the heat setting. The highest number represents the hottest setting and the lowest represents the coolest setting. Choose a setting appropriate to the quantity and type of food to be cooked.
- This model has the added feature of two **Reflex** hotplates which react more quickly than the other ceramic hotplates and are easily identified by their instant red glow.

RECOMMENDED SAUCEPANS

For speed and economy only good quality saucepans with flat bases and close fitting lids are recommended. The saucepan base should be approximately the same size as the cooking area, a base diameter of up to 225mm (9in) may be used on a 180mm (7in) heated area.

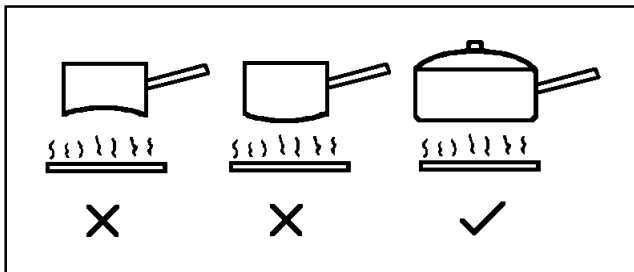

Ensure that new saucepans are well scrubbed to remove edges and take off any deposits left from manufacture.

Pressure cookers, preserving pans, etc., should comply with the recommendations given above.

Traditional round-bottomed Woks must not be used even with a stand. Woks with flat-bottomed bases are available and do comply with the above recommendations.

NOTE

Occasionally the heated areas may be seen to switch ON and OFF when higher heat settings are being used. This is due to a safety device which prevents the glass from overheating. Some switching ON and OFF when cooking at high temperatures, e.g. deep fat frying is quite normal, causes no damage to the hob and little delay in cooking times.

Excessive switching may, however, be caused by the use of an unsuitable saucepan or a saucepan which is smaller than the heated area. If excessive switching occurs, discontinue use of the saucepan.

HINTS AND TIPS

- Lift, rather than slide saucepans on and off the heated areas. This will reduce the risk of scratches and metal marks from saucepans with aluminium bases. Metal marks can be easily cleaned off providing they are not allowed to burn on.

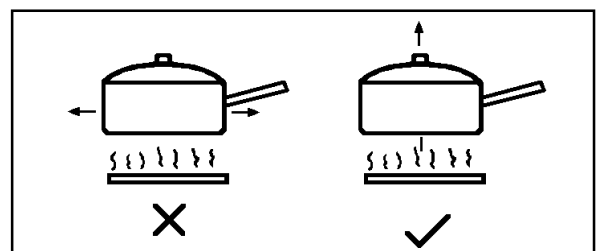

- Follow any guidelines provided by the saucepan manufacturer, particularly those relating to recommended heat settings.
- Avoid using thin, badly dented or distorted saucepans. Those with uneven bases should not be used.

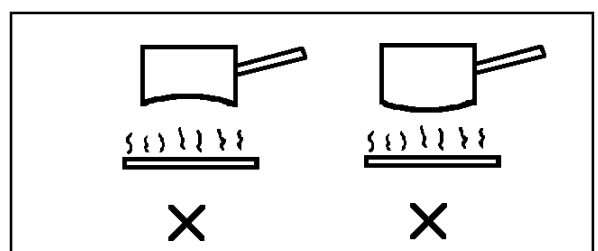

- To prolong the life of the hotplates:-
 - Never use utensils with a skirt, e.g. a bucket
 - Never use an asbestos mat
 - Never leave the hotplates ON when not covered with a saucepan.
- Ensure that hob and saucepans are clean and dry before the start of cooking to reduce cleaning.
- Follow the cleaning instructions very closely to keep the hob looking like new.

If spillage occurs with sugar solutions, e.g. jams and syrups, it must be wiped from the hob before it sets and becomes hard, otherwise damage to the hob will occur.

HOT HOB INDICATOR

The hob is fitted with a hot hob indicator light which illuminates when the hob is too hot to touch. The light will go OFF when the hob has cooled.

DEEP FAT FRYING

SPECIAL FRYING NOTE:

For safety purposes when deep fat frying, fill the pan one-third full of oil, DO NOT cover the pan with a lid and DO NOT leave the pan unattended. In the unfortunate event of a fire, switch OFF at the electricity supply and cover the pan with a lid or damp cloth to assist in smothering the flames.

DO NOT use water on the fire. Leave the pan to cool for at least 30 minutes before moving it.

DO NOT leave the fat or oil in the frying pan on the hob to store it in case the hob is inadvertently switched ON.

1. Preparing the food

Seal the food by coating with flour, egg and breadcrumbs or batter. **Do not** use a basket with batter coated foods as they will stick.

2. Amount of oil

For safety purposes fill the pan only one-third full of oil.

3. Testing the temperature of the oil

It is advisable to use a thermometer to test the temperature of the oil. Alternatively, drop a small cube of bread into the oil which should brown in just under a minute if the oil is at the correct temperature of 190°C/375°F.

4. Cooking the food

Lower the food gently into the oil. **Do not** add too much food at once or the temperature of the oil will be reduced and may result in soggy, greasy food.

Turn the food if necessary; doughnuts float to the surface so will not brown on the upperside if not turned. Once cooked, drain the food on absorbent paper.

5. Double frying chips

Double frying will ensure good chips. First fry the chips for a few minutes at 170°C/340°F to seal the outside. Remove the chips from the oil. Increase the temperature of the oil to 190°C/375°F to finish cooking and brown the chips.

Chips may be kept for several hours after the first frying before finishing off with the second frying.

6. Frying temperatures

	Celsius Scale (°C)	Fahrenheit Scale (°F)
	150	300
First frying of potatoes	170	340
	175	350
	180	360
Second frying of potatoes	190	375
Frying chicken and fish	195	380
	200	390

PRESERVING

1. DO NOT use a pan that overlaps the perimeter of the hob trim.

2. To allow for a full rolling boil, the pan should be no more than one third full when all the ingredients have been added. It is better to use two pans rather than overfill one, or use half quantities.

3. Use firm fruit or vegetables and wash well before using.

4. Preserving sugar gives clear jam, however granulated sugar is cheaper and gives equally good flavour.

5. Crystallization may be caused if sugar is not completely dissolved before bringing jam to the boil. Over boiling will affect the flavour, setting properties and colour of the jam.

6. To test jam for setting:

If a jam thermometer is available, boil jam to 104°C. Marmalade should be boiled to 106°C.

If a jam thermometer is not available, remove pan from heat, place sample of jam on a cold dish and cool quickly (i.e. in a freezer or frozen food storage compartment of a refrigerator). When cold, it will crinkle and hold the mark of a finger run through it, if it is ready.

7. The scum should be removed as soon as possible after setting, but marmalade should be allowed to cool before potting to prevent the peel rising.

THE DUAL GRILL

USES OF THE GRILL

CAUTION - ACCESSIBLE PARTS MAY BECOME HOT WHEN THE GRILL IS IN USE. CHILDREN SHOULD BE KEPT AWAY.

The grill is a dual circuit grill which means that the full area of the grill can be used or for economy purposes, the centre section only can be used when cooking smaller quantities of food.

SELECTING THE GRILL

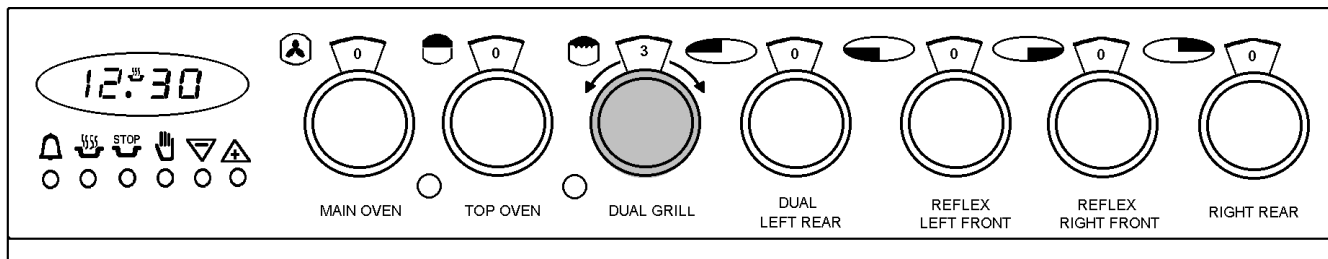

- To operate the dual grill, turn the grill control clockwise for full area grilling, and anti-clockwise for centre section grilling only. The highest number represents the hottest setting and the lowest the coolest setting.
- The cooling fan will operate immediately in conjunction with the grill.

THINGS TO NOTE

THE GRILL DOOR MUST BE LEFT OPEN DURING GRILLING.

If the grill door is accidentally closed during grilling, a safety device incorporated in the appliance will cut out the grill to indicate to the user there is a fault. This will occur after approximately 10 minutes.

The cranked shelf **MUST** only be used in the grill compartment, but a straight shelf from the main oven may be used to provide alternative positions.

Some smoke from fat splashes may be evident as the grill cleans itself.

The top oven **cannot** be operated when the grill is in use. If the grill and top oven controls are selected at the same time, only the top oven will operate.

The outer grill element may appear to glow slightly brighter than the inner element. This is quite normal.

THE GRILL PAN AND HANDLE

The grill pan is supplied with a removable handle.

To insert the handle, press the button on the handle with the thumb and pivot the handle slightly upwards inserting the lip into widest part of the bracket. Move the handle towards the left, lower into position and release the button.

Ensure the handle is positively located.

When removing the handle, press the button on the handle with the thumb and pivot the handle slightly upwards and towards the right to remove from the bracket.

Ensure your hand is protected when removing the grill pan handle as the grill element can become very hot.

ALWAYS REMOVE THE GRILL PAN HANDLE DURING GRILLING.

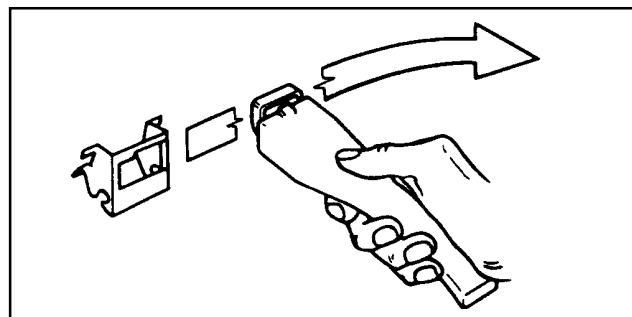

To correctly locate the grill pan on the shelf, ensure that the cut out on the underside of the handle bracket locates over the front bar of the shelf.

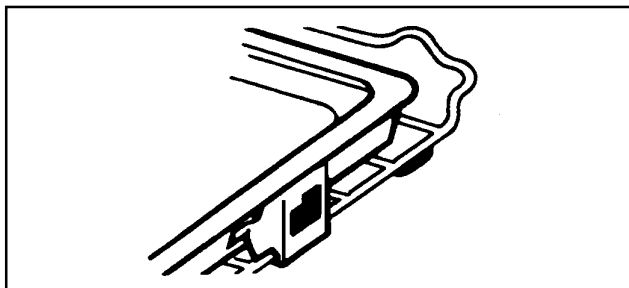

To check the progress of the food being grilled, the grill pan should be withdrawn on the shelf to tend the food during cooking, or the carrier shelf can be lifted away from the cooker and rested on a heat resistant work surface.

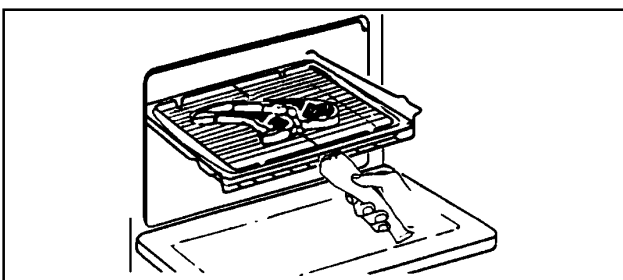

HINTS AND TIPS

- Food should be thoroughly dried before grilling to minimise splashing. Brush lean meats and fish lightly with a little oil or melted butter to keep them moist during cooking.
- Adjust the grid and grill pan runner position to allow for different heights of food.

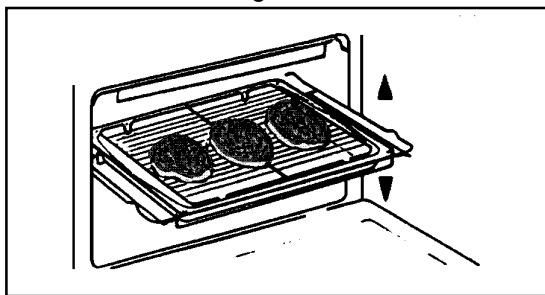

- The use of the trivet beneath the grid when grilling fatty food will keep fat splashing to a minimum.
- Place food on the grill pan grid in the grill pan or on the trivet in the grill pan.

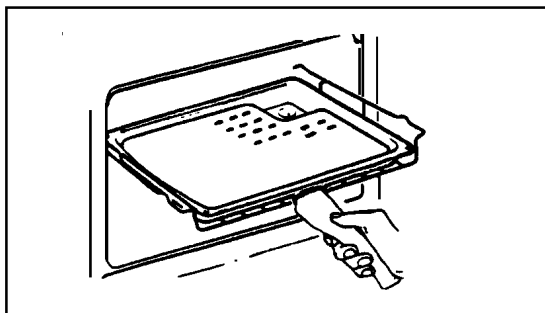

- Accompaniments such as tomatoes and mushrooms may be placed underneath the grid when grilling meats.

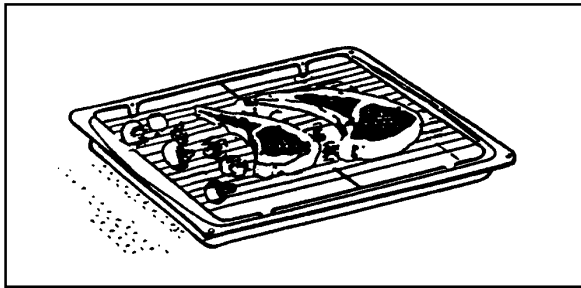

- When toasting bread use the cranked shelf in position 2 with the grid in the high position.
- Preheat the grill on a full setting for a few minutes before cooking. Adjust the heat setting and the shelf as necessary during cooking.
- The food should be turned over during cooking as required.

GRILLING CHART

FOOD	SHELF	GRILL TIME (mins)
Bacon Rashers	2 crk.	2-3 each side
Beefburgers	2 crk.	6-10 each side
Chicken Joints	2 crk.	15-20 each side
Chops - Lamb	2 crk.	7-10 each side
Pork	2 crk.	10-15 each side
Fish - Whole Trout/Mackerel	2 crk.	8-12 each side
Fillets - Plaice/Cod	2 crk.	4-6 each side
Kebabs	2 crk.	10-15 each side
Kidneys - Lamb/Pig	2 crk.	4-6 each side
Liver - Lamb/Pig	2 crk.	5-10 each side
Sausages	2 crk.	10-15 each side
Steaks - Rare	2 crk.	3-6 each side
Medium	2 crk.	6-8 each side
Well Done	2 crk.	7-10 each side
Toasted Sandwiches	2 crk.	1¼-1½ each side

crk. = cranked shelf

Shelf positions are counted from the bottom upwards.

The times quoted above are given as a guide and should be adjusted to suit personal taste.

THE TOP OVEN

USES OF THE TOP OVEN

The top oven is the smaller of the two ovens. It is heated by elements in the top and bottom of the oven. It is designed for cooking on one level and for smaller quantities of food. It gives especially good results if used to cook fruit cakes, sweet or savoury flans or quiche.

The top oven is also ideal for use as a warming compartment to warm dishes and keep food hot. Use a temperature setting of 80-100°C on the top oven control dial.

SELECTING THE TOP OVEN

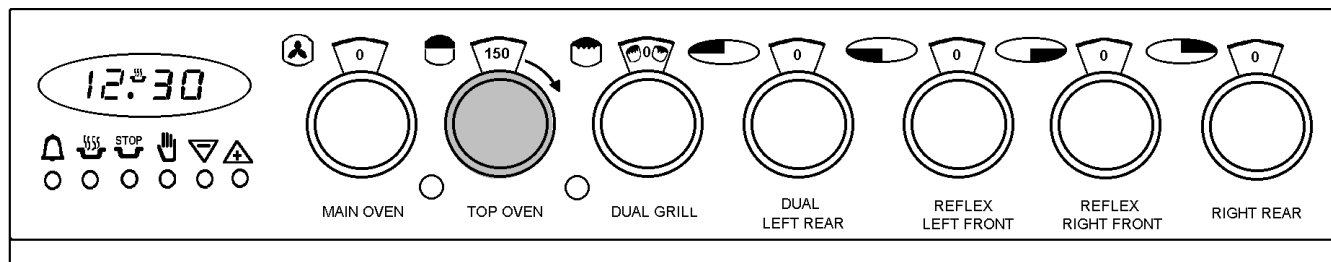

- Turn the top oven temperature control to the required setting.

THINGS TO NOTE

1. The grill cannot be operated when the top oven is in use. If the grill and top oven controls are selected at the same time, only the top oven will operate, although the controls for both may illuminate.
2. The top oven indicator neon will glow until the oven has reached the desired temperature and then go out. It will then cycle ON and OFF showing that the oven temperature is being maintained.
3. The cooling fan will operate immediately with the top oven. See page 9 for more details on the operation of the cooling fan.

TO FIT THE TOP OVEN SHELF

The cranked shelf must only be used in the top oven compartment but a straight shelf from the main oven may be used to provide alternative positions.

The shelf should be fitted with the straight rods uppermost on the frame and the forms towards the back of the oven. If not fitted correctly the anti-tilt and safety stop mechanism will be affected.

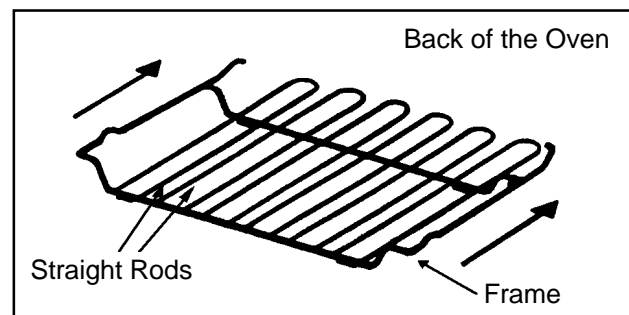

HINTS AND TIPS

- Most cooking should be carried out using an oven shelf positioned in one of the shelf runners.

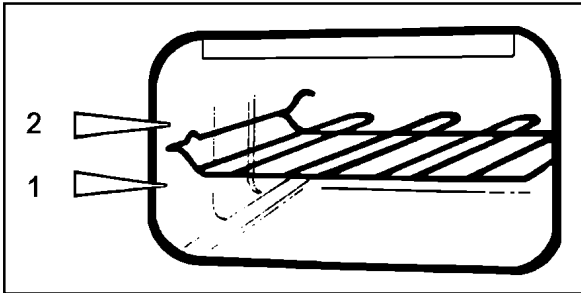

- Larger roasts and casseroles should normally be cooked in the main oven. However, they may be cooked on a flat shelf from the main oven placed on the base of the top oven provided there is sufficient room for air circulation around the food.
- Stand dishes on a suitably sized baking tray on the shelf to prevent spillage onto the oven base and to help reduce cleaning.

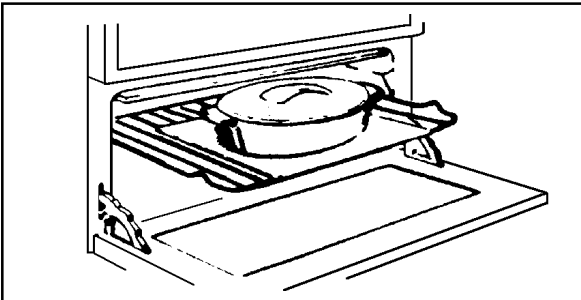

- There should always be at least 2.5cm (1") between the top of the food and the element. This gives best cooking results and allows room for rise in yeast mixtures, Yorkshire puddings, etc.
- When cooking cakes, pastry, scones, bread, etc., place the tins or baking trays centrally on the shelf directly below the element.

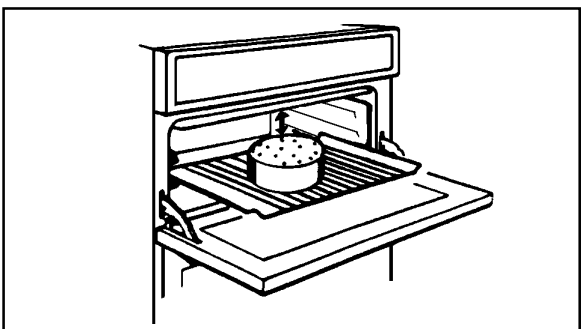

- DO NOT place dishes directly onto the oven base as it becomes very hot and damage may occur.

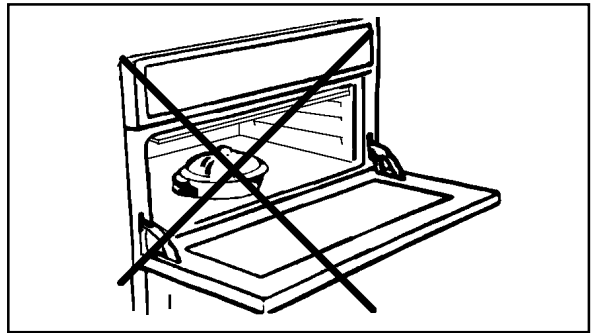

- The material and finish of the baking trays and dishes will affect the degree of base browning of the food. Enamelware, dark, heavy or non-stick utensils increase base browning. Shiny aluminium or polished steel trays reflect the heat away and give less base browning.
- DO NOT use the grill pan as a baking tray as this will increase base browning of the food.
- Because of the smaller cooking space, lower temperatures and shorter cooking times are sometimes required. Be guided by the recommendations on pages 23 and 24.
- For economy leave the door open for the shortest possible time, particularly when placing food into a pre-heated oven.

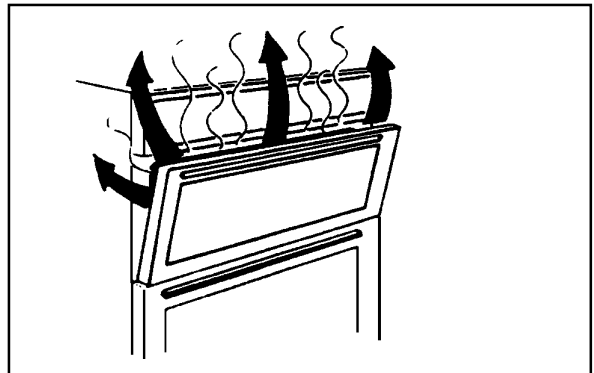

AUTOMATIC COOKING

If you use the automatic timer to cook food in the top oven be guided by the recommendations given below.

- * It is advisable to leave food in the oven for as short a time as possible before automatic cooking.
- * When cooking is complete do not leave food to stand in the oven, but remove and cool it quickly if the food is not to be consumed immediately.
- * Always ensure food in the oven is covered if its not possible to remove food immediately after cooking.

THE MAIN FAN OVEN

USES OF THE FAN OVEN

PREHEATING

The fan oven quickly reaches its temperature, so it is not usually necessary to preheat the oven. Without preheating, however, you may find you need to add an extra 5 - 10 minutes on the recommended cooking times. For recipes needing high temperatures, e.g. bread, pastries, scones, soufflés, etc., best results are achieved if the oven is preheated first.

COOKING TEMPERATURES

Fan oven cooking generally requires lower temperatures than conventional cooking. Follow the temperatures recommended in the chart on page 23. As a guide reduce temperatures by about 20°C - 25°C for your own recipes.

BATCH BAKING

The fan oven cooks evenly on all shelf levels, especially useful when batch baking on three shelves.

SELECTING THE FAN OVEN

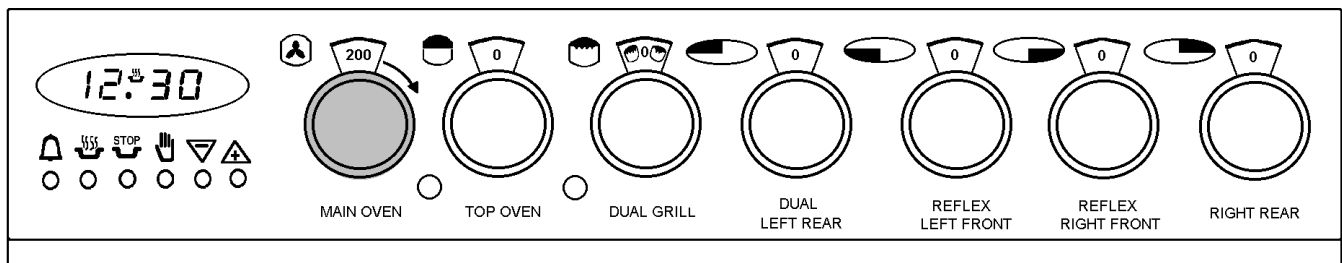

- Turn the main oven temperature control to the required setting.

THINGS TO NOTE

1. The main oven indicator neon will glow until the oven has reached the desired temperature and then go out. It will cycle ON and OFF periodically during cooking showing that the temperature is being maintained.
2. The interior oven light will come ON when the temperature is selected.
3. The cooling fan for the controls may switch in after a time. See page 9 for more information on the operation of the cooling fan.

TO FIT THE MAIN OVEN SHELVES

The shelves should be fitted with the straight rods uppermost on the frame and the forms towards the back of the oven. If not fitted correctly the anti-tilt and safety stop mechanism will be affected.

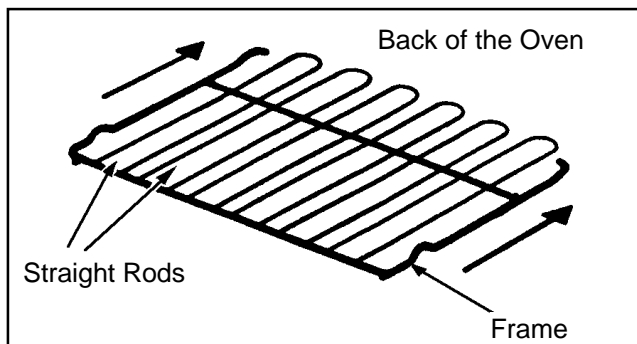

HINTS AND TIPS

- Arrange the shelves in the required positions before switching the oven ON. Shelves are numbered from the bottom upwards.

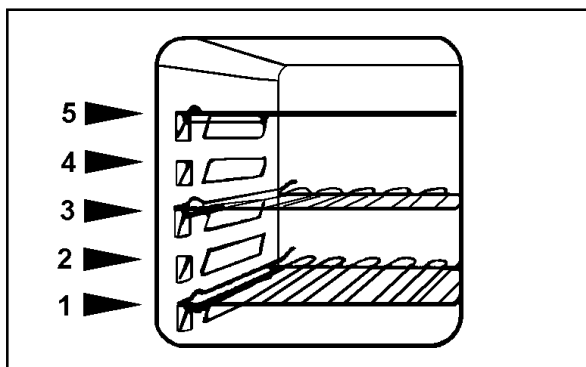

- When cooking more than one dish in the fan oven, place dishes centrally on different shelves rather than cluster several dishes on one shelf. This will allow the heat to circulate freely for the best cooking results.
- When batch baking one type of food, e.g. Victoria sandwich cakes, those of similar size will be cooked in the same time.

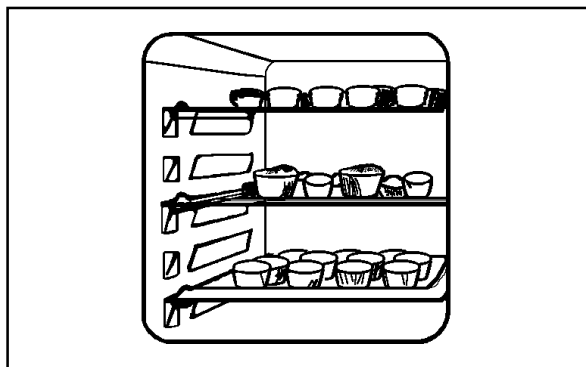

- It is recommended that when baking larger quantities, the shelf positions should be evenly spaced to suit the load being cooked. A slight increase in cooking time may be necessary.
- Do not place dishes or baking trays directly on the oven floor as it interferes with the oven air circulation and can lead to base burning; use the lower shelf position. However non critical dishes can be placed on the oven base when more space is required.

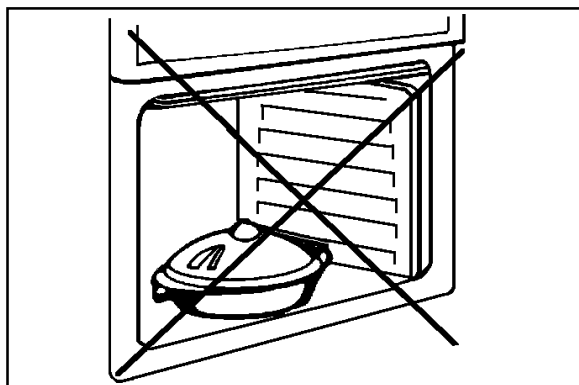

- The use of excessively high temperatures can cause uneven browning. It may be necessary to reduce temperatures slightly. Refer to the recommendations given in the oven cooking charts on pages 23 and 24.
- DO NOT use the cranked shelf from the grill in the main oven.

AUTOMATIC COOKING

If you use the automatic timer to cook food in the main oven be guided by the recommendations below.

- * It is advisable to leave food in the oven for as short a time as possible before automatic cooking.
- * When cooking is complete do not leave food to stand in the oven, but remove and cool it quickly if the food is not to be consumed immediately.
- * Always ensure food in the oven is covered if its not possible to remove food immediately after cooking.

OVEN COOKING CHART

The oven temperatures are intended as a guide only. It may be necessary to increase or decrease the temperatures by 10° C to suit individual preferences and requirements.

FOOD	FAN OVEN		TOP OVEN		
	SHELF POSITION	COOKING TEMP °C	SHELF POSITION	COOKING TEMP °C	APPROX COOK TIME (m)
Biscuits		180-190	1 crk.	170-190	10 - 20
Bread		200-220	1 crk.*	200-220	25 - 30
Bread rolls/buns	Shelf	200-220	1 crk.	200-220	15 - 20
Cakes:					
Small & Queen		160-170	1 crk.	180-190	18 - 25
Sponges		160-170	1 crk.	160-170	18 - 20
Victoria Sandwich	positions	160-170	1 crk.	160-170	18 - 25
Madeira		140-150	1 crk.	140-150	1¼ - 1½h
Rich Fruit		130-140	1 crk.	130-140	2¼ - 2½h
Christmas	are not	130-140	1 crk.	130-140	3 - 4½h
					depends on size
Gingerbread		140-150	1 crk.	140-150	1¼ - 1½h
Meringues	critical	80-100	1 crk.	90-100	2½ - 3h
Flapjack		170-180	1 crk.	170-180	25 - 30
Shortbread		130-140	1 crk.	140-150	45 - 65
Casseroles:					
Beef/lamb	but ensure	140-160	1 crk.*	140-160	2½ - 3h
Chicken		180-190	1 crk.*	180-190	1¼ - 1½h
Convenience Foods		Follow manufacturer's instructions			
Fish	that oven	170-190	1 crk.	170-190	20 - 30
Fish Pie (Potato Topped)		190-200	1 crk.*	190-200	20 - 25
Fruit Pies, Crumbles		190-200	1 crk.	190-200	40 - 50
Milk Puddings	shelves are	130-140	1 crk.	140-150	1½ - 2h
Pasta, Lasagne etc.		190-200	1 crk.	170-180	40 - 45
Pastry:					
Choux		190-200	1 crk.	180-190	30 - 35
Eclairs, Profiteroles	evenly	170-180	1 crk.	170-180	20 - 30
Flaky/Puff Pies		210-220	1 crk.*	210-220	25 - 40
Shortcrust					
Mince Pies		190-200	1 crk.	190-200	15 - 20
Meat Pies	spaced	190-210	1 crk.*	190-210	25 - 35
Quiche, Tarts, Flans		180-210	1 crk.	180-200	25 - 45
Patés and Terrines		150-160	1 crk.	150-160	1-1½h
Roasting Meat, Poultry	when more	160-180	1 crk.*	160-180	see roasting chart
Scones		210-220	1 crk.	220-230	8 - 10
Shepherd's Pie		190-200	1 crk.*	190-200	30 - 40
Soufflés	than one is	170-180	1 crk.	170-180	20 - 30
Vegetables:					
Baked Jacket Potatoes		180-190	1 crk.	180-190	1-1½h
Roast Potatoes		180-190	1 crk.	180-190	1-1½h
Stuffed Marrow	used	180-190	1 crk.	180-190	30 - 35
Stuffed Tomatoes		180-190	1 crk.	180-190	15 - 20
Yorkshire Puddings: Large		210-220	1 crk.	200-210	25 - 40
Individual		200-210	1 crk.	200-210	15 - 25

crk. = cranked shelf

* or on a straight shelf on the oven base

Note: Shelf positions are counted from the bottom of the oven.
Do not use the cranked shelf from the grill in the main oven.

ROASTING CHART

ROASTING CHART		
INTERNAL TEMPERATURES - Rare : 50-60°C; Medium : 60-70°C; Well :70-80°C		
MEAT	SECOND/FAN OVEN	COOKING TIME
Beef	160-180°C	20-35 min per ½kg/1lb and 20-35 min over
Beef, boned	160-180°C	20-35 min per ½kg/1lb and 25-35 min over
Mutton and Lamb	160-180°C	25-35 min per ½kg/1lb and 25-35 min over
Pork and Veal	160-180°C	30-40 min per ½kg/1lb and 30-40 min over
Ham	160-180°C	30-40 min per ½kg/1lb and 30-40 min over
Chicken	160-180°C	15-20 min per ½kg/1lb and 20 min over
Turkey and Goose	160-180°C	15-20 min per ½kg/1lb up to 3½kg/7lb then 10 min per ½kg/1lb
Duck	160-180°C	25-35 min per ½kg/1lb and 25-30 min over
Pheasant	160-180°C	35-40 min per ½kg/1lb and 35-40 min over
Rabbit	160-180°C	20 min per ½kg/1lb and 20 min over
Potatoes with meat	160-180°C	according to size
Potatoes without meat	180-190°C	according to size

The roasting temperatures and times given in the chart should be adequate for most joints, but slight adjustments may be required to allow for personal requirements and the shape and texture of the meat. However, lower temperatures and longer cooking times are recommended for less tender cuts or larger joints.

Wrap joints in foil if preferred, for extra browning uncover for the last 30 - 60 min. cooking time.

DEFROST FEATURE

USES OF DEFROST FEATURE

This fan oven function defrosts most foods faster than more conventional methods. It is particularly suitable for delicate frozen foods which are to be served cold e.g. cream filled gateaux, cakes covered with icings or frostings, cheesecakes, biscuits, scones etc.

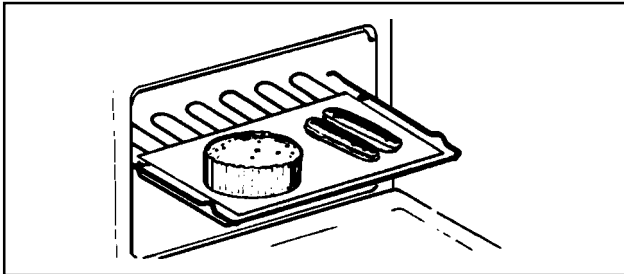

It is preferable to thaw fish, meat and poultry slowly in the fridge. However, this process can be accelerated by using the defrost function.

SELECTING DEFROST

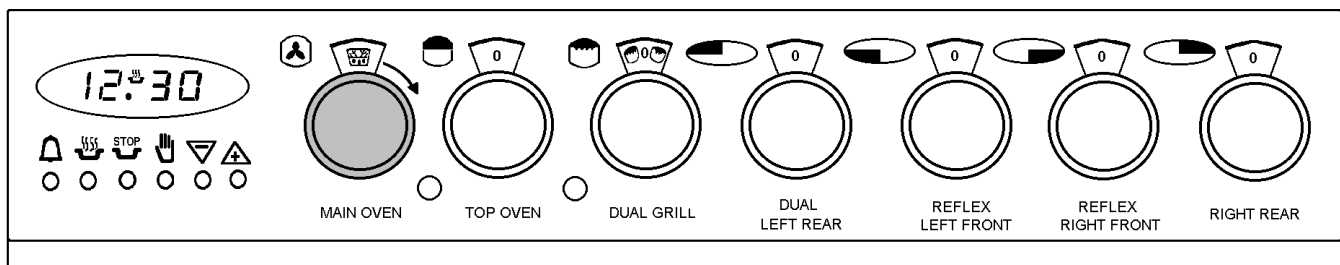

- Turn the main oven temperature control to the defrost setting. 

THINGS TO NOTE

1. When defrost is selected, the oven indicator neon may come ON. It will stay ON until the oven reaches room temperature and then go OFF. It may cycle ON and OFF periodically during defrosting to maintain a steady room temperature, inside the oven.
2. Care must always be taken when handling foods in the home. Always follow the basic rules of food hygiene to prevent bacterial and microbial growth and cross contamination when defrosting, preparing, cooking, cooling and freezing foods.

Small or thin fish fillets, frozen peeled prawns, cubed or minced meat, liver, thin chops, steaks etc., can be thawed in 1 - 2 hours.

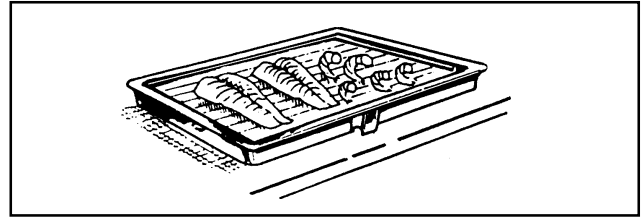

A 1kg/2¼lb oven ready chicken will be thawed in approximately 5 hours. Remove the giblets as soon as possible during the thawing process.

Joints of meat up to 2kg/4½lb in weight can be thawed using the defrost function.

ALL JOINTS OF MEAT AND POULTRY MUST BE THAWED THOROUGHLY BEFORE COOKING.

ALWAYS COOK THOROUGHLY IMMEDIATELY AFTER THAWING.

HINTS AND TIPS

- Place the frozen food in a single layer where possible and turn it over half way through the defrosting process.

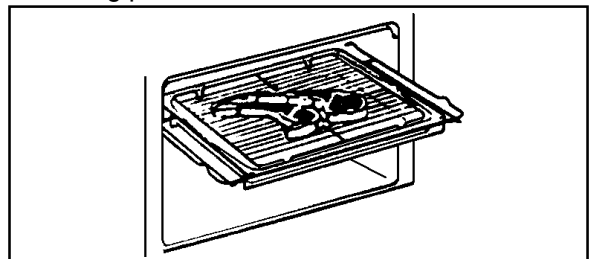

- The actual speed of defrosting is influenced by room temperature. On warm days defrosting will be faster than on cooler days.
- **DO NOT** leave food at room temperature once it is defrosted. Cook raw food immediately or store cooked food in the fridge.

CARE AND CLEANING

BEFORE CLEANING ALWAYS ALLOW THE COOLING FAN TO COOL THE APPLIANCE DOWN BEFORE SWITCHING OFF AT THE ELECTRICITY SUPPLY.

CLEANING MATERIALS

Before using any cleaning materials on your cooker, check that they are suitable and that their use is recommended by the manufacturer.

Cleaners that contain bleach should NOT be used as they may dull the surface finishes. Harsh abrasives should also be avoided. Multi-surface anti bacterial products should not be used on the ceramic hob or on the surrounding trims.

CLEANING THE VITREOUS ENAMEL

Use a clean damp cloth or scourer made for non-stick saucepans with 'Jif' or 'Flash' cream cleaner.

AFTER CLEANING

To maintain the appearance of the hotplates occasionally apply a little salt free vegetable oil or commercial restorative agent e.g. '4 Hob' or use a 'Minky' Hotplate Cleaning Cloth.

To apply vegetable oil, first heat the hotplate on a medium setting for 30 seconds then turn OFF. Pour a very small amount of oil onto kitchen paper, apply the paper to the hotplate and wipe off any excess oil. Heat the hotplate on a medium setting for 1 minute.

To apply restorative agent, apply a thin coating of '4 Hob' or use a Minky cloth following the manufacturers instructions.

CLEANING THE CERAMIC HOB

Make sure the ceramic glass is cool before cleaning. It is important to clean the ceramic hob daily to prevent soilage being burnt on.

Take care to avoid the hob trims when cleaning the ceramic glass as they may be damaged by the cleaning agents recommended.

DAILY CLEANING

Use the recommended Hob Brite Cleaner daily. If soilage is not allowed to burn on it will be much easier to clean off.

1. Apply a small amount of Hob Brite in the centre of each area to be cleaned.

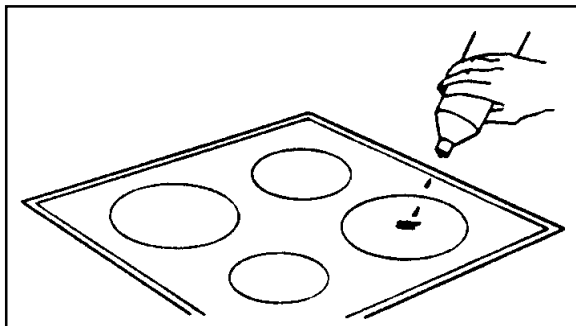

2. Dampen a clean paper towel or a plastic pad made specially for non-stick saucepans and rub vigorously until all marks are removed. This may take a few minutes.
3. Wipe off residues of cleaner with another damp paper towel and polish dry with a soft cloth.

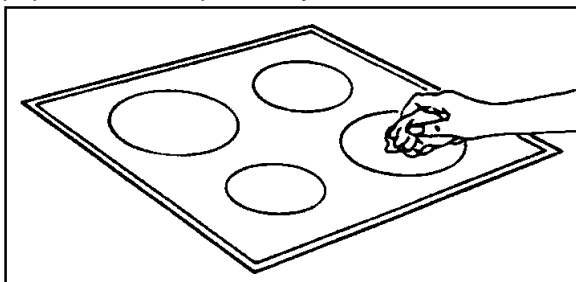

If Hob Brite is unavailable, one or more of the cleaning agents below may be used temporarily:

- a) Flash Cream Cleaner
- b) Jif Cream Cleaner
- c) Baking Soda

TO REMOVE MORE STUBBORN MARKS

1. Bar-Keepers Friend may be used to clean off more stubborn stains or to remove discolourations. It may be necessary to rub the marks hard for several minutes.
2. Use the scraper supplied with the cooker with care at an angle of 45° to the hob to remove more stubborn marks. Then apply Hob Brite to clean off any remaining soilage.

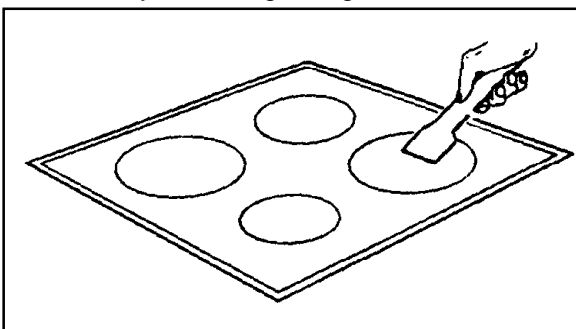

TO REMOVE DISCOLOURATIONS OR WHITE AND SILVER MARKS

These marks sometimes give the impression of being in or underneath the hob glass. They can almost always be removed provided they have not become excessively burnt on. Follow the instructions under 'To Remove more Stubborn Marks' above.

If this is unsuccessful, make up a paste of one part water to three parts Cream of Tartar and leave on the discoloured areas overnight. The marks should be easily removable the next day provided they have not been excessively burnt on. The paste should be thoroughly washed off afterwards.

HINTS AND TIPS

TO REDUCE HOB SOILAGE:

- Make sure the bottom of the saucepan and the cooking area are clean and dry before cooking begins.
- Ensure saucepans are large enough to accommodate food to avoid boil overs.
- If possible, wipe up spills and splatters as they occur, but take care to avoid steam burns.
- Avoid using a dishcloth or sponge to clean the hob. These may leave a layer of soiled detergent on the hob surface which will burn and discolour the next time the hob is used.
- Avoid the use of:
 - Household detergents and bleaches.
 - Impregnated plastic or nylon pads not described as suitable for non-stick saucepans.
 - Brillo pads, Ajax pads, steel wool pads.
 - Chemical oven cleaners, e.g. aerosols and oven pads.
 - Rust stain, bath and sink stain removers.
- **Any of the above products may cause damage to the hob.**
- It is dangerous to mix different cleaning products. The chemicals in them may react with each other with hazardous results.
- **SOILAGE FROM SUGAR SOLUTIONS MUST BE REMOVED FROM THE HOB BEFORE THE SYRUP HAS SET OTHERWISE DAMAGE TO THE HOB SURFACE WILL OCCUR.**
- Avoid placing plastic items, aluminium foil or dishes on the hot surface as this will cause damage to the hob.

CLEANING THE OUTSIDE OF THE COOKER

DO NOT use abrasive cleaning materials, or scourers on the outside of the cooker as some of the finishes are painted and damage may occur. Regularly wipe over the control panel, oven doors and cooker sides using a soft cloth and liquid detergent.

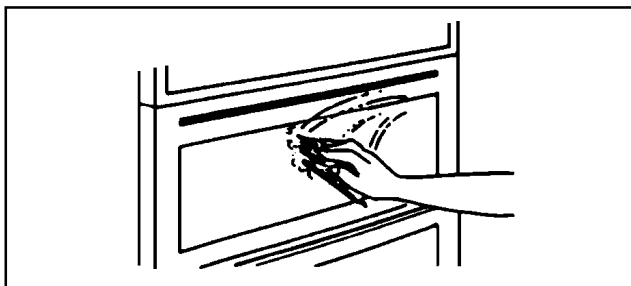

DO NOT ATTEMPT TO REMOVE ANY OF THE CONTROL KNOBS FROM THE PANEL AS THIS MAY CAUSE DAMAGE AND IS A SAFETY HAZARD.

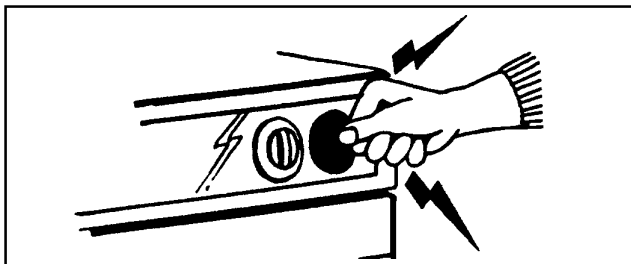

CLEANING THE GRILL DEFLECTOR, GRILL PAN, GRILL PAN GRID, MEAT TIN AND OVEN SHELVES

All removable parts, except the grill pan handle can be washed in the dishwasher.

The grill pan, meat tin, grill deflector and oven shelves may be cleaned using a soap impregnated steel wool pad. The grill pan grid should be cleaned using hot soapy water. Soaking first in soapy water will make cleaning easier .

CLEANING INSIDE THE GRILL/OVEN COMPARTMENTS

The sides, top and back of the grill/top oven and main oven are coated with a special Stayclean coating.

The Stayclean coating should not be cleaned manually.

The vitreous enamel fan oven base and grill compartment base, can be cleaned using normal oven cleaners or aerosol oven cleaners with care. Ensure that the manufacturers instructions are followed and that all parts are well rinsed afterwards.

Aerosol cleaners must not be used on Stayclean surfaces and must not come into contact with elements as this may cause damage.

For advice on how to keep the Stayclean coating in good condition see 'Care of Stayclean Surfaces'.

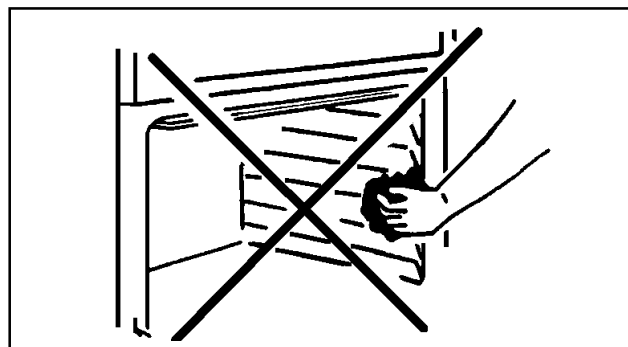

CARE OF STAYCLEAN SURFACES

Stayclean surfaces destroy splashes of food and fats when the oven temperature is raised to around 220°C.

It is a good idea to run the oven for an hour or two per week to ensure continued good performance from the Stayclean finish.

Do use the trivet in the roasting tin. During roasting, the fat from the joint will be contained beneath the trivet and therefore prevent it from splashing onto the Stayclean finish.

HINTS AND TIPS

- Manual cleaning of Stayclean Surfaces IS NOT recommended. Damage will occur if oven sprays or abrasives of any kind are used.
- Slight discolouration and polishing of the Stayclean surface may occur in time. This does not affect the Stayclean properties in any way.
- A good time to allow the oven to run on is after the weekly roast. After removing the roast, turn the oven up to 220°C and allow to run for an hour or so. It is important NOT to allow a build-up of soilage as this can prevent the Stayclean from working.
- Follow the recommendations below to keep oven soilage to a minimum.
- Cook at the recommended temperatures. Higher temperatures during roasting will increase soilage. Try cooking at lower temperatures for an increased length of time, you will save energy and often the joint is more tender.
- Use minimal, if any, extra oil or fat when roasting meat, potatoes only require brushing with fat before cooking. Extra fat in the oven during roasting will increase splashing and soilage.

- It is NOT necessary to add water to the meat tin when roasting. The water and the fat juices from the joint create excessive splattering during cooking - even at normal temperatures, as well as causing condensation.
- Covering joints during cooking will also prevent splashing onto the interior surfaces. Removing the covering for the last 20-30 minutes will allow extra browning if required. Some large joints and turkeys especially benefit by this method of cooking, allowing the joint to cook through before the outside is over-browned.

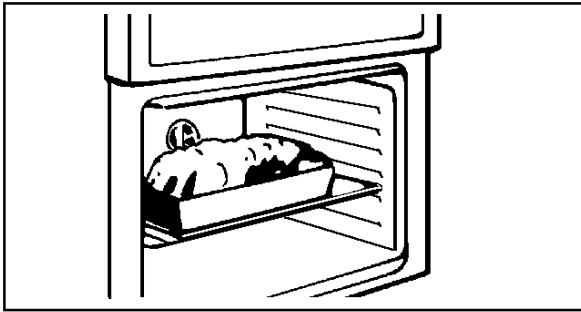

CLEANING BETWEEN THE OUTER AND INNER DOOR GLASS

The outer door glass is removable for cleaning.

TO REMOVE THE OUTER GLASS

1. Open the oven door slightly to gain access to the two cross head screws on the top of the oven door.
2. Loosen the two screws using a pozidrive screwdriver.
3. Hold the door glass securely in place with one hand before removing the screws completely with the other hand.
4. Using both hands, gently tilt the top of the door glass towards you. Lift slightly to disengage the locators from the two bottom brackets.

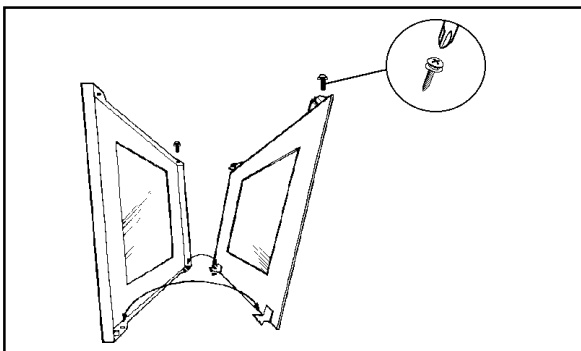

5. Clean the outer and inner glass using hot soapy water or Flash Cream cleaner may be used. DO NOT try to clean the aluminium foil which is inside the door. The foil is there to help keep the door cool, if it is damaged it will not work. Ensure that all parts are well rinsed and thoroughly dry before attempting to replace the outer door.

TO REPLACE THE OUTER GLASS

1. Holding the oven door glass with both hands, gently place the locators into the holes of the brackets at the bottom of the oven door.
2. Push the top of the oven glass towards the oven door, ensuring the screw location holes line up.
3. Hold the glass in place with one hand and insert the cross head screws into the location holes with the other hand. Give the screws one turn to ensure the glass is secure.
4. Tighten the screws positively with a pozidrive screwdriver before closing the oven door.

Do not attempt to use the oven without the glass being in place.

TO CLEAN INSIDE THE INNER GLASS DOOR

The inner glass door is not removable. Clean using hot soapy water or Flash Cream Cleaner and a soft cloth. Take care NOT to use abrasives as they may damage the glass or seal.

REPLACING THE OVEN LIGHT BULB

The type of bulb required is a 300C 25 watt small Edison Screw. Part number 572 491 5431-00/1 (Available through Tricity Bendix service centres).

CAUTION: Disconnect the appliance from the electricity supply before replacing the bulb.

Open the door and remove the shelves to enable easy access to the oven light assembly. Insert a flat blade screwdriver between the oven side and the glass which covers the bulb.

Support the glass with your hand and prise out sufficiently to release the glass cover. Unscrew the bulb in a anticlockwise direction until it is possible to remove the bulb with ease.

Fit the new bulb by turning in a clockwise direction until it is secure. Ensuring the indent to the flange is pointing to the rear of the oven, replace the glass by pushing it firmly into the hole to cover the bulb assembly.

Replace the shelves. Restore the electricity supply and adjust the time of day and clock, as necessary.

SOMETHING NOT WORKING?

We strongly recommend that you carry out the following checks on your appliance before calling a Service Engineer. It may be that the problem is a simple one, which you can solve yourself without the expense of a service call.

If our Service Engineer finds that the problem is listed below you will be charged for the call whether or not the appliance is under guarantee.

The cooker does not work at all:

- * Check that the appliance has been wired in and is switched on at the wall.
- * Check that the main cooker fuse is working.
- * Check that the timer is set to manual (see page 11).

The grill and hotplates work but the oven does not:

- * Check that the timer is set to manual operation (see page 11).

The oven temperature is too high or low:

- * Check that the recommended temperatures are being used (see page 23). Be prepared to adjust up or down by 10°C to achieve the results you want.

The hotplates and main oven work but the grill does not:

- * Check that you have carefully followed the instructions for operation of the grill.
- * If the cooling fan fails, the grill will not operate. Please call your Customer Service Centre.

If the oven is not cooking evenly or the side opening door will not stay open:

- * Check that the cooker is level.

If the oven fan is noisy:

- * Check that the cooker is level.
- * Check that shelves and bakeware are not vibrating in contact with the back panel in the oven.

SERVICE AND SPARE PARTS

HELP US TO HELP YOU

Please determine your type of enquiry before writing or telephoning.

SERVICE

It is a recommendation by the manufacturer that annual servicing of the product is done by the manufacturers approved service organisation.

In the event of your appliance requiring service Tricity Bendix Limited have an arrangement with Electrolux Group Service.

Before calling out an Engineer, please ensure you have read the details under the heading "Something Not Working?" and have the model number and purchase date to hand. The telephone number and address for service is detailed on the list headed "Customer Service Centres".

PLEASE NOTE that all enquiries concerning service should be addressed to your local Customer Service Centre.

CONSUMER CARE DEPARTMENT

FOR GENERAL ENQUIRIES concerning your Tricity Bendix cooker or further information on Cooking, Cooling or Washing products, you are invited to contact our Consumer Care Department by letter or telephone as follows:

Consumer Care Department
Tricity Bendix Limited
99 Oakley Road
Luton
Bedfordshire LU4 9QQ
Tel: (01582) 585858

CUSTOMER SERVICE CENTRES

The Regional Electricity Companies are responsible for the servicing of cookers sold by their own outlets. The telephone numbers can be found in the telephone directory.

Service for cookers bought from other outlets can be obtained by calling the nearest Customer Service Centre on the numbers given below. The areas are defined by postcode for easy reference.

CENTRE	POSTAL DISTRICTS	SERVICE APPOINTMENTS	ADDRESS
ABERDEEN	AB	01224-696569	Electrolux After Sales Service Northeast Appliance Service 8 Cornhill Arcade Cornhill Drive Aberdeen AB2 5UT
ARGYLL	PA 24-61	01369-703161	Electrolux After Sales Service T.D.C. Refrigeration Briar Hill 7 Hill Street Dunoon Argyll PA23 7AL
BARNSTAPLE	EX18-23, 31-39	01271-328826	Electrolux After Sales Service McBain Refrigeration Unit 4 Upcott Avenue Pottington Industrial Estate Barnstaple N.Devon EX31 1HN
BORDERS	TD	01573-224411	Electrolux After Sales Service James Stewart & Son 2-8 Wood Market Kelso Borders TD5 7AX
BRISTOL	BA BS TA SP	0117-9211876	Electrolux After Sales Service Unit BE46 PO Box 372 Bristol BS99 1UD
CANVEY	E EC EN N NW W WC AL CB HA HP LU MK SG UB WD CM CO IG RM SS IP NR PE14-19,30-38	0181-443-3464 0181-965-9699 0181-965-9699 01268-694144 01603-667017	Electrolux After Sales Service 2-4 Sandhurst Kings Road Canvey Island SS8 0QY
CARDIFF	CF NP1-4, 6, 9-44,SA1-18 SA21-32	01222-460131	Electrolux After Sales Service Guardian Industrial Estate Clydesmuir Road Tremorfa Cardiff CF2 2QS
CUMBRIA	CA	01228-594747	Electrolux After Sales Service E.T.B. Services Carlisle Enterprise Centre James Street Carlisle CA2 5AP
DUMFRIES & GALLOWAY	DG1-14	01387-265166	Electrolux After Sales Service Allan Crossan (Service) 93 Irish Street Dumfries Scotland
DUNDEE	Parkinson Cowan Gas Only	01382-642828	Electrolux After Sales Service Tayside Refrigeration 3-7 Blackness Street Dundee DD1 5LR
DUNDEE	DD1-14 PH8-18	01250-876285	Electrolux After Sales Service 1 Brogan Domestic 41 Leslie Street Blairgowrie Perthshire PH10 6AT

GLASGOW	EH FK G KA KY1-16 ML PA1-23, PH1-7	0141-647-4381	Electrolux After Sales Service 20 Cunningham Road Clyde Estate Rutherglen Glasgow G73 1PP
GUERNSEY	All Codes	01481-46931	Guernsey Electricity PO Box 4 Vale Guernsey Channel Islands
HAVERFORDWEST	SA33-39 SA41-44 SA61-73	01437-710914	Electrolux After Sales Service C Butherway 1 Church Road. Roch Haverfordwest Dyfed Wales SA62 6AG
HEREFORD	HR1-9 LD1-8 SY7 ,18 NP5 NP7-8	01432-340334	Electrolux After Sales Service Domestic Repair Centre Unit 3 Bank Buildings Cattle Market Hereford HR4 9HX
HULL	YO4 YO11-18 YO25 HU1-19 DN14	01482-585678	Electrolux After Sales Service John Sizer Unit 1 Boulevard Unit Factory Estate Hull HU3 4AY
INVERNESS	IV1-28, 30-36, 52-56, PH19-26, 42-44 KW1-14	01463-792952	Electrolux After Sales Service Highland Appliances Unit 3B3 Smithton Industrial Est Smithton Inverness
INVERNESS	PH30-41 IV40-51	01855-821315	Electrolux After Sales Service George Ross Electrical Forrestry Workshop Inchree Onich Inverness-shire PH33 6SE
ISLE OF WIGHT	PO30-41	01983-872552	Electrolux After Sales Service Wyatts Electrical Service 4 Forelands Road Bembridge Isle of Wight PO35 5XW
ISLE OF ARRAN	KA27	01770-302909	Electrolux After Sales Service Arran Domestic Unit 4 The Douglas Centre Brodick Isle of Arran KA27 8AJ
ISLE OF MAN	IM	01624-663455	Electrolux After Sales Service Manx Electricity Service Workshop North Quay Douglas Isle of Man
ISLE OF MULL	PA62-75	01688-302262	Electrolux After Sales Service B Hogg Braeside Raeric Road Tobermory Isle of Mull PA75 6PU
JERSEY	ALL CODES	01534-505050	Jersey Electricity Company PO Box 45 Queens Road St Helier Jersey, Channel Islands JE4 8NY
LAMPETER	SA19,20 SA40 SA45-48 SY23-25	01570-423020	Electrolux After Sales Service Lampeter Domestic Appl. Services Unit 16 Lampeter Ind. Est. Lampeter SA48 7DY

LANCASTER	LA1-23	01772-316175	Electrolux After Sales Service NL Services Unit 333 Ranglet Road Walton Summit Bamber Bridge Preston, Lancashire PR5 8AR
LEEDS	BD DN1-7, 10-12, HD HG HX LS S WF YO1-3, 5-8 DE NG1-22 & 25	0113-2608511	Electrolux After Sales Service 64-66 Cross Gates Road Leeds LS15 7NN
LINCOLN	DN21 sub codes 1 2 & 5 only, LN1, 2, 4,5,6 LN3 sub codes 4 & 5 only LN8-10 NG 23,24 31-34 PE1-13, 20-25	01522-514603	Electrolux After Sales Service Brian Hudson Unit 8 Stonefield Park Clifton Street Lincoln LN5 8AA
LIVERPOOL	FY PR L WN CH CW WA (Not WA 14/15)	0151-2541724	Electrolux After Sales Service Unit 1 Honeys Green Precinct Honeys Green Lane West Derby Liverpool L12 9JH
MANCHESTER	BB BL OL M SK WA14 & 15 only	0161-4777758	Electrolux After Sales Service Unit 30 Oakhill Trading Estate Devonshire Road Worsley Manchester M28 3PT
NEWTON ABBOTT	EX1-17 TQ PL1-9, 16, 19-21	01626-65909	Electrolux After Sales Service South West Domestic Service Unit 2 Zealley Industrial Est Kingsteignton Newton Abbott South Devon TQ12 3SJ
NORTH WALES	LL	01745-591616	Electrolux After Sales Service GMS (Cymru) Unit 2 Coed- Parc Abergele Road Rhuddlan Clwyd, Wales LL18 5UG
NORTHERN	DL TS DH YO21, 22 DH NE SR	01325-301400 0191-493-2025	Electrolux After Sales Service PO Box 40 Preston Road Aycliffe Industrial Estate Newton Aycliffe, Co Durham DL5 6XA
NORTHERN IRELAND EAST	BT1-30, 36-57, 63-67	01232-746591	Electrolux After Sales Service Unit C3 Edenderry Industrial Estate 326 Crumlin Road Belfast BT14 7EE
NORTHERN IRELAND WEST	BT31-35, 60-62, 68-82, 92-94	01861-510400	Electrolux After Sales Service G & O (Armagh) Service Owenmore House Kilwee Business Park Upper Dunmurray Lane Belfast BT17 0HD
NUNEATON	B DY ST TF WR WS WV GL NN OX SN CV LE	0121-358-7076 0121-358-5051 01993-704411 01203-350420	Electrolux After Sales Service Unit 23-24 Alliance Business Pk Townsend Drive Nuneaton Warwickshire CV11 6RX
ORKNEY	KW15-17	01856-875457	Electrolux After Sales Service Refrigeration Sales and Services Hatson Ind. Estate Kirkwall Orkney
REDDITCH	TBA	TBA	Electrolux After Sales Service Heming Road Washford Redditch Worcestershire B98 ODH

REDRUTH	TR1-20, 26, 27 PL10-15, 17, 18, 22-35	01209-314407	Electrolux After Sales Service Cornwall Domestic Service Unit 7D Pool Industrial Estate Wilson Way Redruth Cornwall TR15 3QW
ROTHSAY	PA20	01700-504777	Electrolux After Sales Service D McGlashan Walker Walker Engineering Glenmhor Upper Serpentine Rothesay PA20
SHETLAND	Own Sales	01595-692225	Electrolux After Sales Service Tait Electronic Systems Ltd. Holmsgarth Road Lerwick Shetland ZE1 OPW
SHETLAND	Own Sales	01595-692855	Electrolux After Sales Service Bolts Shetland Ltd. 26 North Road Lerwick Shetland ZE1 OPE
SHETLAND	ZE2	01806-566546	Electrolux After Sales Service Leask Electrical Harsdale Symbister Shetland ZE2 9AA
SHREWSBURY	SY1-6 SY8-17 SY19-22	01743-450279	Electrolux After Sales Service BLI Service 6 Harlescott Barn Harlescott Lane Shrewsbury SY1 3SY
SOUTH COAST	BN16-18. GU27-35 PO1-22. BH DT SO TR21-25	01705-667411 01705-667411 0117-9211876	Electrolux After Sales Service Limerline Road Hilsea Portsmouth Hampshire PO3 5JJ
SOUTH HUMBERSIDE	DN 8, 9, DN15-20 DN21 sub codes 3,4 only DN31-40 LN (3 sub code 6 only), 7 LN11-13	01472-267978	Electrolux After Sales Service John Robinson (Electrical) Unit 74 New Enterprise Centre King Edward Street Great Grimsby DN31 3JP
TONBRIDGE	SL GU1-26. RG CT DA ME TN BN1-15, 20-27, RH TW BR CR SE SW SM KT	01252-24505 01732-357722 01273-694341 0181-658-9069	Electrolux After Sales Service Unit 30 Deacon Trading Estate Morley Road Tonbridge Kent TN9 1RA

We, Tricity Bendix, undertake that if within 12 months of the date of the purchase this Tricity Bendix appliance or any part thereof is proved to be defective by reason only of faulty workmanship or materials, we will, at our option repair or replace the same FREE OF ANY CHARGE for labour, materials or carriage on condition that:

- The appliance has been correctly installed and used only on the electricity supply stated on the rating plate.
- The appliance has been used for normal domestic purposes only and in accordance with the manufacturers operating and maintenance instructions.
- The appliance has not been serviced, maintained, repaired, taken apart or tampered with by any person not authorised by us. Any servicing or repairs carried out by any unapproved third party will invalidate the approvals status of this product.
- All service work under this guarantee must be undertaken by a Tricity Bendix service representative or authorised agent.
- Any appliance or defective part replaced shall become the Company's property.
- This guarantee is in addition to your statutory and other legal rights.

EXCLUSIONS

This guarantee does not cover:

- Damage or calls resulting from transportation, improper use or neglect, the replacement of any light bulbs or removable parts of glass or plastic.
- Cost incurred for calls to put right an appliance which is improperly installed or calls to appliances outside the United Kingdom.
- Appliances found to be in use within a commercial environment, plus those which are subject to rental agreements.
- Products of Tricity Bendix manufacture which are not marketed by Tricity Bendix.
- EEC Countries. The standard guarantee is applicable but subject to the owners responsibility and cost to ensure the appliance meets the standards set by the Country of which the product is taken. Electrolux Aftersales Service in the Country concerned, with whom Tricity Bendix have an arrangement, will be pleased to advise further.

RATING PLATE REFERENCE

MAKE AND MODEL NO.	SERIAL NO.	DATE OF PURCHASE

IMPORTANT NOTICE

In line with our continuing policy of research and development, we reserve the right to alter models and specifications without prior notice.

This handbook is accurate at the date of printing, but will be superseded and should be disregarded if specifications or appearance are changed.

TRICITY BENDIX

Better Products. Better Value.

TRICITY BENDIX, 99 OAKLEY ROAD, LUTON, BEDFORDSHIRE, LU4 9QQ

A Division of Emaco Limited · Registered in England No. 176547 · Registered Office. 101 Oakley Road, Luton LU4 9RJ.

MODEL NO.
SI 452



PART NO.
311351700

Free Manuals Download Website

<http://myh66.com>

<http://usermanuals.us>

<http://www.somanuals.com>

<http://www.4manuals.cc>

<http://www.manual-lib.com>

<http://www.404manual.com>

<http://www.luxmanual.com>

<http://aubethermostatmanual.com>

Golf course search by state

<http://golfingnear.com>

Email search by domain

<http://emailbydomain.com>

Auto manuals search

<http://auto.somanuals.com>

TV manuals search

<http://tv.somanuals.com>