



OPERATING AND INSTALLATION INSTRUCTIONS

MODEL NO.
SI 535

TECHNICAL DETAILS

MODEL NO. SI 535

Voltage: 230/240 Volts AC 50Hz

Wattage: 10.4/11.3kW

Height: 900mm

Width: 600mm

Depth: 598mm

This appliance complies with: European Council Directive 73/23/EEC.
EMC Directive 89/336/EEC.
CE Marking Directive 93/68/EEC.

CONTENTS

Technical Details	2
Contents	3
Preface	5
Safety	6
Before Installation	6
During Operation	6
After Use	7
General	7
Introduction	8
Rating Plate	8
Installation	8
Reversible Main Oven Door	9
General Notes on Using your Cooker	9
About Condensation and Steam	9
Pop In Pop Out Control Knobs	9
The Cooling Fan for the Controls	9
The Shelf Positions	9
Control Panel Indicator Neons	9
Grill and Oven Furniture	10
Getting to know your Cooker	11
The Control Panel	11
The Programmer - Automatic Timer	12
The Ceramic Hob	15
Recommended Saucepans	15
Hints and Tips	16
Hot Hob Indicator	16
Deep Fat Frying	16
Preserving	17
The Dual Grill	18
Uses of the Dual Grill	18
Selecting the Dual Grill	18
The Grill Pan and Handle	18
Hints and Tips	19
Grilling Chart	19
The Top Oven	20
Uses of the Top Oven	20
Selecting the Top Oven	20
To Fit the Top Oven Shelf	20
Hints and Tips	20
Top Oven Cooking Chart	22
The Fan Oven	23
Uses of the Fan Oven	23
Selecting the Fan Oven	23
Things to Note	23
To Fit the Main Oven Shelves	24
Hints and Tips	24

CONTENTS

The Conventional Oven	25
Uses of the Conventional Oven	25
Selecting the Conventional Oven	25
Things to Note	25
Hints and Tips	25
Multifunction Oven Cooking Chart	26
Defrost Feature	27
Uses of Defrost Feature	27
Selecting Defrost Feature	27
Things to Note	27
Hints and Tips	27
Care and Cleaning	28
Cleaning Materials	28
Cleaning the Ceramic Hob	28
Hints and Tips	29
Cleaning the Outside of the Cooker	29
Removing and Replacing Wirework Side Runners	29
Cleaning the Grill Deflector, Grill Pan, Grill Pan Grid, Oven Shelves and Wirework Side Runners	30
Cleaning inside the Oven/Grill Compartments	30
Cleaning between the Outer and Inner Door Glass	30
Care of Stayclean Surfaces	31
Hints and Tips	31
Replacing the Oven Light Bulb	31
Something not Working?	32
Service and Spare Parts	33
Customer Service Centres	34
Guarantee Conditions	36

PREFACE

Dear Customer,

Thank you for buying a Tricity Bendix cooker. With our 80 years experience in developing and manufacturing the very best in U.K. cookers, you can be assured that you have purchased a hard working, reliable, quality product.

Tricity Bendix cookers comply with British Standard safety and performance requirements. They have been approved by BEAB (British Electrotechnical Approvals Board) and are covered by a 12 month parts and labour guarantee.

To get the best from your new Tricity Bendix cooker, we ask that you **PLEASE READ THESE INSTRUCTIONS CAREFULLY**. Particular attention should be made to cooking times and temperatures which may differ from your previous cooker.

It is most important that this instruction book is retained with the appliance for future reference. Should the appliance be sold, or if you move house and leave the appliance, always ensure that the book remains with the appliance. This will enable the new owner to be acquainted with the functioning of the appliance and the relevant warnings.

Please read the whole instruction book before attempting to use the appliance ensuring you follow the recommendations given.

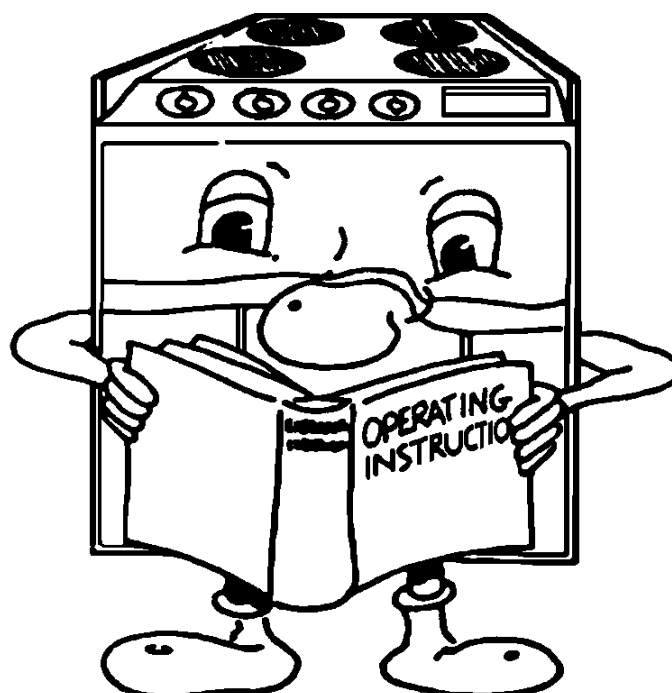

SAFETY

THESE WARNINGS ARE PROVIDED IN THE INTERESTS OF YOUR SAFETY. ENSURE THAT YOU UNDERSTAND THEM ALL BEFORE INSTALLING OR USING THE COOKER.

PLEASE
READ
CAREFULLY



BEFORE INSTALLATION



This cooker is heavy and care **must** be taken when moving it.

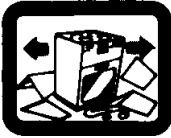

Ensure that all packaging, both inside and outside the cooker has been removed before the appliance is used.



Do not try to move the cooker by pulling the door handles.

The electrical installation work **must** be undertaken by a qualified electrician/ competent person.



It is **dangerous** to alter or modify the specifications of the cooker in any way.

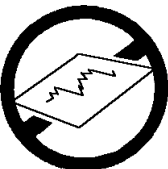

Do not use the cooker if the ceramic glass is damaged. If a fault or crack becomes visible during cooking, disconnect the cooker immediately from the electricity supply and contact the Customer Service Centre. **Do not** place silver foil or plastic containers on ceramic glass.



After installation, please dispose of the packaging with due regard to safety and the environment.

DURING OPERATION



Do not use this cooker if it is in contact with water. **Never** operate it with wet hands.



This cooker is designed to be operated by adults. Young children **must not** be allowed to tamper with the cooker or play with the controls.

Accessible parts especially around the grill area may become hot when the cooker is in use. Children should be **kept away** until it has cooled.



Take **great care** when heating fats and oils as they will ignite if they become too hot.

This cooker has been designed for cooking edible foodstuffs only, and **must not** be used for any other purposes.



Never place plastic or any other material which may melt in the oven or on the hob.



Ensure cooking utensils are large enough to contain foods to prevent spillages and boil overs.

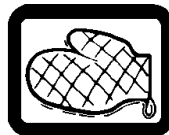

The handles of saucepans which are smaller than the heated area on the hob will become hot. **Ensure** your hand is protected before handling the pan.



Take care to follow the recommendations given for tending the food when grilling.

Do not leave the grill pan handle in position when grilling as it will become hot.

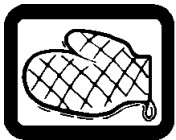

Always use oven gloves to remove and replace food in the oven.



Ensure that you support the grill pan when it is in the withdrawn or partially withdrawn position.

Ensure that all vents are left unobstructed to ensure ventilation of the oven cavity.

Ensure that the anti-tilt shelves are put in place correctly. Refer to instructions on pages 20 and 24.

Never line any part of the cooker with aluminium foil.



Always stand back from the cooker when opening the oven door to allow any build up of steam or heat to release.



Do not place sealed cans or aerosols inside the oven. They may explode if they are heated.

Do not leave the hotplates switched ON for long periods when not covered by a saucepan. The controls may overheat.

AFTER USE



Ensure that all control knobs are in the OFF position when not in use.



For hygiene and safety reasons this cooker should be kept clean at all times. A build-up of fats or other foodstuffs could result in a fire, especially in the grill pan.



Do not leave utensils containing foodstuffs, e.g. fat or oil in or on the cooker in case it is inadvertently switched ON.

Cookers and hobs become very hot, and retain their heat for a long period of time after use. Children should be kept well away from the cooker until it has cooled.

GENERAL



Under no circumstances should repairs be carried out by inexperienced persons as this may cause injury or serious malfunction. This cooker should be serviced by an authorised Service Engineer and only genuine approved spare parts should be used. Details of servicing and repair arrangements are supplied on page 33 of this book.



Do not stand on the cooker or on the open oven door.



Do not hang towels, dishcloths or clothes from the cooker or its handle. They are a safety hazard.



Always allow the cooling fan to cool the cooker down before switching off at the wall prior to carrying out any cleaning or maintenance work.



Only clean this cooker in accordance with the instructions given in this book. Extreme care must be taken when using a ceramic hob scraper.

Your safety is of paramount importance.

Therefore, if you are unsure about any of the meanings of these WARNINGS contact the:

Consumer Care Department
Telephone (01635) 525542

INTRODUCTION

WARNING: THIS COOKER MUST BE EARTHED

RATING PLATE

Record the model, product and serial numbers on the back cover of this instruction book from the rating plate. This is situated on the lower front frame of the cooker and can be seen upon opening the main oven door.

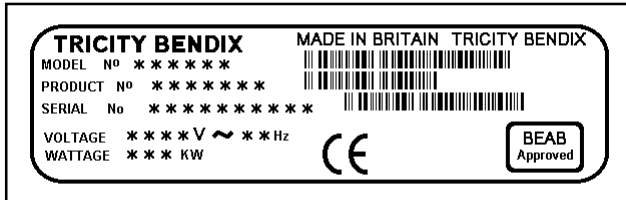

The cooker must be protected by a suitably rated fuse or circuit breaker. The rating of the cooker is given on the rating plate.

INSTALLATION

If your cooker has been damaged in transit, contact your supplier immediately. **DO NOT** attempt to install it.

Your cooker left the factory fully packaged to protect it from damage. If it is delivered without packaging and damage has occurred, the manufacturer cannot accept responsibility. Contact your supplier for advice.

Once the packaging has been removed the cooker should only be moved by hand. **DO NOT** use a sack barrow or any other aid to lift the cooker as damage may occur.

Connection to the electricity supply must be carried out by a qualified electrician/competent person.

The electrical connection should be made using a double pole isolating switch (cooker socket) with at least 3mm contact separation. The cable must have conductors of sufficiently high cross-sectional area to prevent overheating and deterioration.

Six square millimetres (6.00mm²) is the recommended cross-section area.

The cable should be routed away from potentially hot areas marked by X in the diagram below.

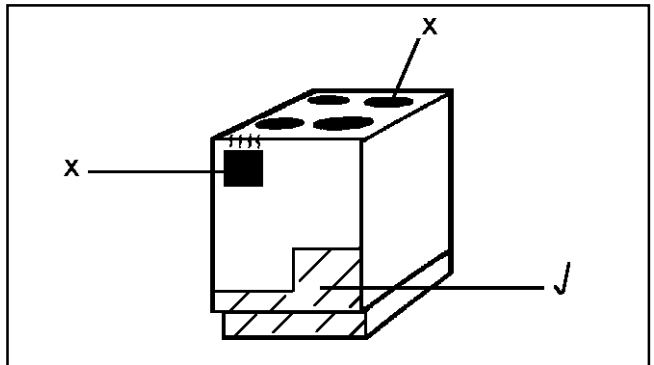

To move the cooker, open the main oven door, remove the grill deflector and lift the cooker by holding inside the top of the oven compartment.

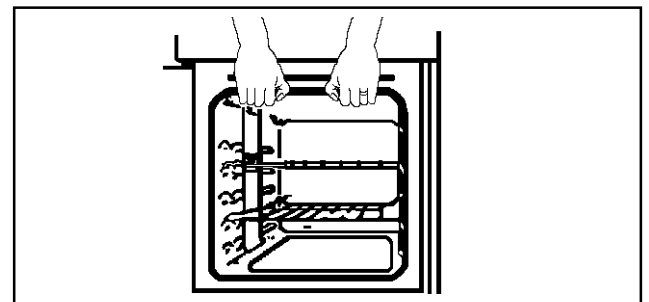

This is a type Y appliance which means it is free-standing and can be fitted with cabinets on one or both sides. It may also be fitted in a corner setting.

Side walls which are above hob level should be protected by heat resistant non-combustible material and **MUST NOT** be nearer than 40mm to the hob side.

A nominal air gap of 2mm at the sides of the cooker is required to enable the cooker to be moved into position.

A spacer has been incorporated into the back of the appliance to ensure an air gap of 10mm is maintained at hotplate level. Tiles or other forms of deep wall covering should not obscure this gap.

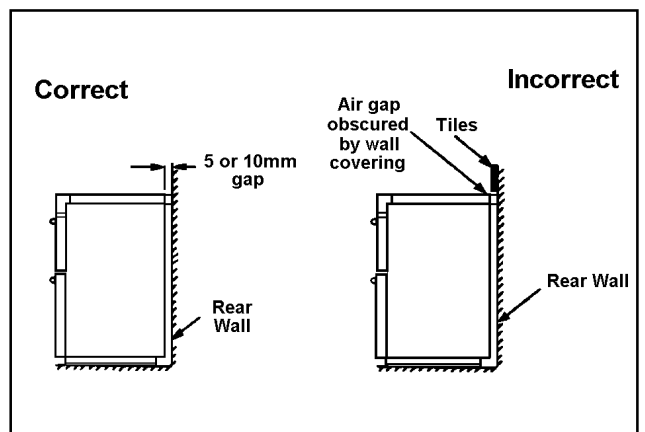

Overhanging surfaces or a cooker hood should be a minimum of 685mm above the hob.

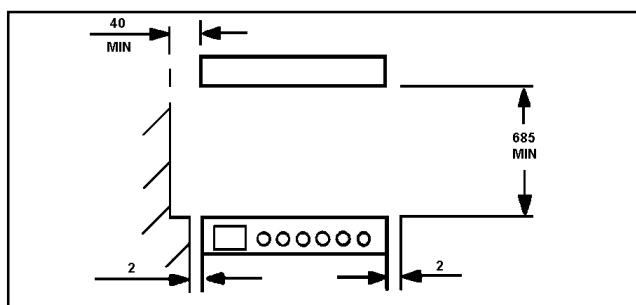

It is important to ensure that the appliance is level after installation. Levelling feet are fitted to the front of the appliance to accommodate uneven floors.

REVERSIBLE MAIN OVEN DOOR

If you require the oven door to be hinged on the opposite side, you will need to contact a qualified Service Engineer. See page 34 for your nearest Service Centre. PLEASE NOTE that a charge will be made.

GENERAL NOTES ON USING YOUR COOKER

We suggest that you run all the elements for a short period to burn off any residue from their surfaces.

To do this, run the ovens at 220°C for approximately 45 minutes. The procedure should be repeated with the grill for approximately 5 - 10 minutes.

During this period an unpleasant odour may be emitted, it is therefore advisable to open a window for ventilation.

ABOUT CONDENSATION AND STEAM

When food is heated it produces steam similar to a boiling kettle. The ovens are vented to allow some of this steam to escape. However, always stand back from the cooker when opening the oven door to allow any build up of steam or heat to release.

If the steam comes into contact with a cool surface on the outside of the cooker, e.g. a trim, it will condense and produce water droplets. This is quite normal and is not caused by a fault on the cooker.

To prevent discolouration, regularly wipe away condensation and also soilage from surfaces.

For your safety wallcoverings at the rear of the appliance should be securely fixed to the wall.

POP IN POP OUT CONTROL KNOBS

These control knobs can remain flush with the control panel when not in use, or pushed and released to stand out from the panel for easy operation.

THE COOLING FAN FOR THE CONTROLS

The cooling fan operates immediately when the grill or top oven is switched on. It may run on after the controls are switched off until the appliance has cooled. If an automatic programme has been set the cooling fan does not switch on until the cook time begins.

NOTE: The action of the cooling fan will depend on how long the top oven or grill have been used and at what temperature. It may not run on where the grill or top oven has only been used for a short time or at low temperatures. **Do not** switch the cooker off at the power point, until the fan has cooled the cooker down.

THE SHELF POSITIONS

Recommended shelf positions have been shown in the cooking charts on pages 22 and 26.

Bulk cooking with even spacing can be achieved using three shelves at any one time, e.g. position 1 straight, position 3 straight and position 5 straight.

It is important that the shelves are fitted right side uppermost and are between the wirework side runners.

If not fitted correctly the shelf will lie at an angle and the safety stop will not be effective. To ensure that the shelf has the correct side uppermost, the wire stringers which make up the shelf should lie on top of the surrounding frame.

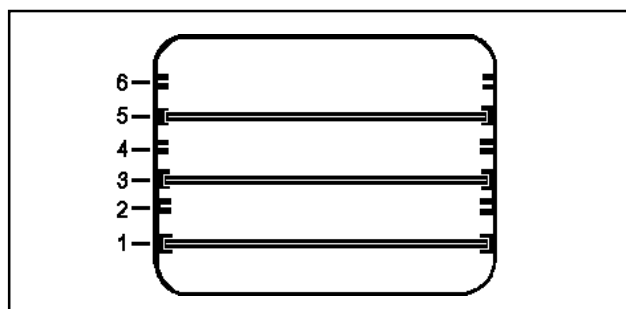

CONTROL PANEL INDICATOR NEONS

These lights indicate whether the ovens are switched on. The neons also indicate when the set temperature has been reached. They will cycle on and off during use to show that the temperature is being maintained. If the neons do not operate as the instructions indicate the controls have been incorrectly set. Return all controls to zero and re-set following the instructions. When the oven has been set for automatic cooking the neon should remain unlit until the cook time begins.

GRILL AND OVEN FURNITURE

The following items of oven furniture have been supplied with the cooker.

1 grill pan



1 grill pan handle

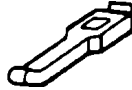

1 grill pan grid

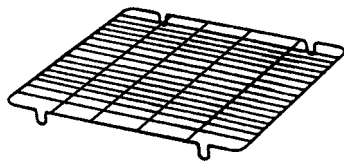

1 grill deflector



1 meat tin

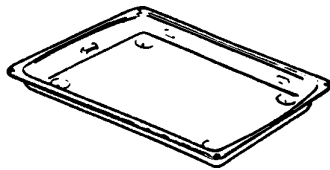

1 trivet

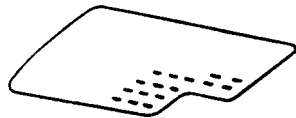

1 cranked shelf

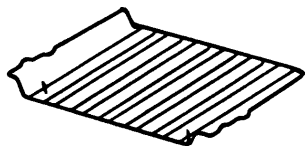

3 straight shelves

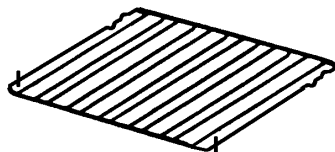

Scuffing of the Stayclean oven lining by the oven furniture pack may occur during transit. These marks will disappear after the oven elements have been burnt off for the first time.

GETTING TO KNOW YOUR COOKER

THE CONTROL PANEL

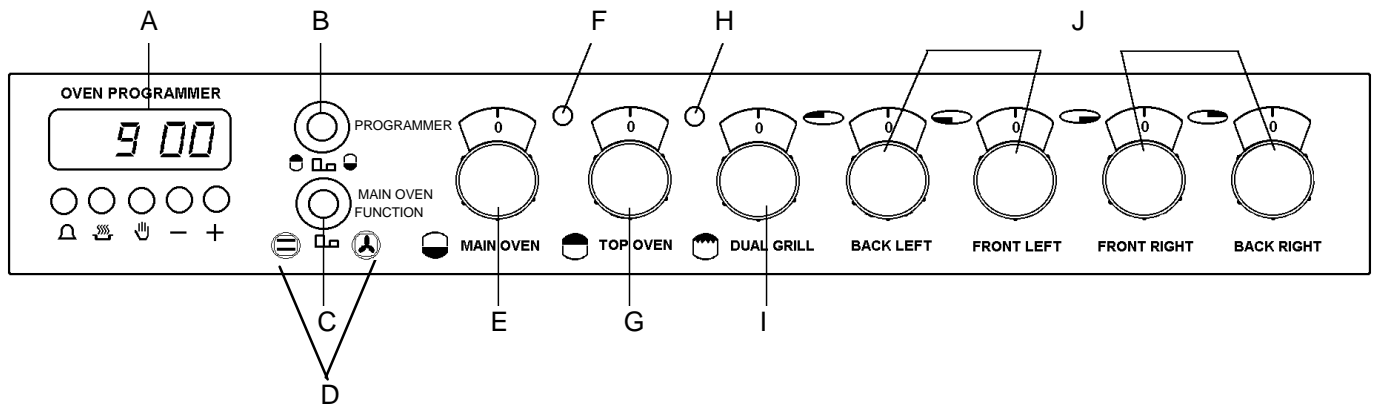

FEATURES

- A - Oven Programmer
- B - Programmer Button
- C - Main Oven Function Button
- D - Function Selector Neon Indicators
- E - Main Oven Temperature Control
- F - Main Oven Neon Indicator
- G - Top Oven Temperature Control
- H - Top Oven Neon Indicator
- I - Dual Grill Control
- J - Hotplate Controls

THE PROGRAMMER

KEY



- A AUTO SYMBOL
- B MINUTE MINDER BUTTON
- C COOKING HOURS BUTTON
- D COOKING SYMBOL
- E MANUAL SELECTOR BUTTON
- F DECREASE CONTROL
- G INCREASE CONTROL

NOTE:

STEPS 1 AND 2 BELOW MUST BE FOLLOWED BEFORE THE OVENS WILL OPERATE MANUALLY.

1. SET THE TIME OF DAY

When the cooker is first switched on at the wall the display flashes as Fig.1.

Press buttons () and () together. Within 5 seconds press the (+) button until the time of day shows in the display.

The cookpot symbol will be lit and the Auto symbol will go out as Fig.2.

THINGS TO NOTE:

The timer has three different tones to the alarm. You can change the sound of the alarm if you wish. To do this ensure the clock shows the correct time of day. Press button (-) to change the sound of the alarm. You will hear each of the three tones with each press of the button. Keep pressing the button until you hear the tone you prefer. The next time the minute minder or timer is used the tone you selected will sound.

2. THE MINUTE MINDER

The minute minder gives an audible reminder at the end of any period of cooking up to 23 hrs 59 mins.

To set, press () and the display shows as Fig.3.

Within 5 seconds press the button (+) until the display shows the interval you want to time, e.g. 5 mins. Display reads as Fig. 4 then reverts to displaying time of day whilst counting down. The time of day reads e.g. 10.00, as Fig.5.

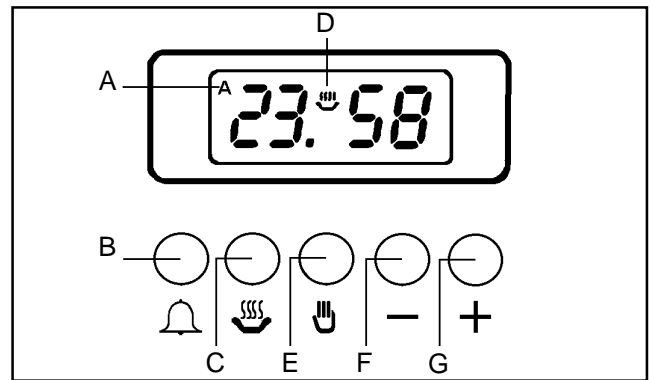

Fig.1

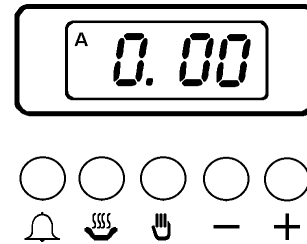

Fig.2

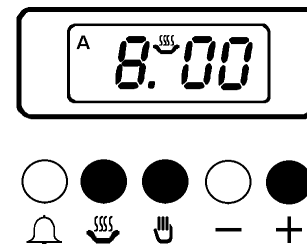

Fig.3

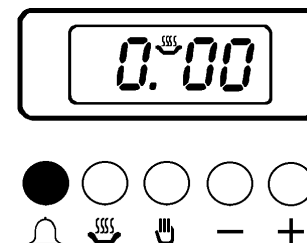
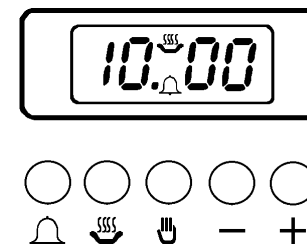



Fig.4



Fig.5





At the end of the timed period an audible signal sounds for up to 7 minutes.

To stop the sound press () button.

The display shows the time of day after a few seconds and the bell symbol will go out. Fig.6.

3. HOW TO SET THE OVEN TIMER CONTROL

A) TO SWITCH ON AND OFF AUTOMATICALLY



- i) Ensure time of day is displayed.
- ii) Place food in oven.
- iii) Set length of cooking time, press () button and within 5 seconds press the (+) button until the length of cooking time is displayed. e.g. 2 hrs. 15 min. Fig.7.
The display shows the auto symbol and cookpot are lit, then reverts to time of day after a few seconds. Fig.8.
- v) Set the STOP time. Press the () button. This shows the earliest possible end time. Within 5 seconds press the (+) control until the required stop time is displayed, e.g. 12.30. The display shows as Fig.9 then after a few seconds the time of day shows in the display as Fig.10.

Select Top or Main oven using the programmer button.

If using the main oven, also select the fan or conventional oven using the Main oven function selector button.



NOTE.

When automatic cooking begins, the oven indicator neon will illuminate and will cycle on and off during cooking to show that the temperature is being maintained.

If using the main oven, the function selector neon () or () will illuminate.

4. RETURNING THE COOKER TO MANUAL OR TO CANCEL AN AUTOMATIC PROGRAMME.



At the end of the timed period, the oven will switch off, an audible sound will be heard and the Auto symbol will flash in the display.

To stop the sound and flashing press buttons () and () together.

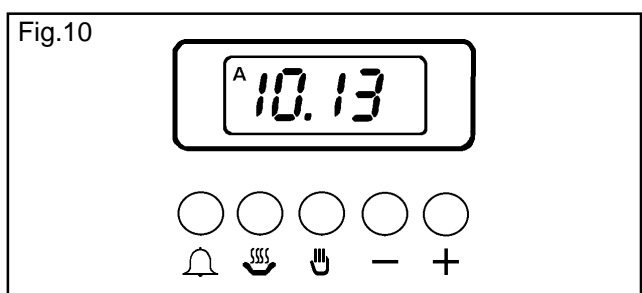
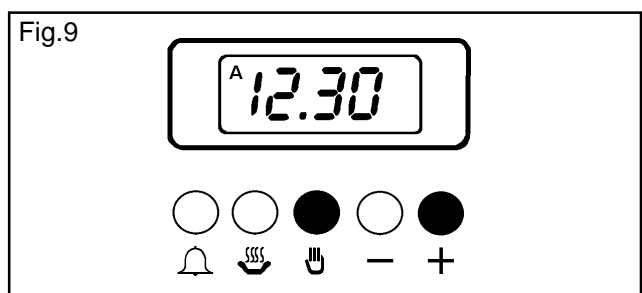
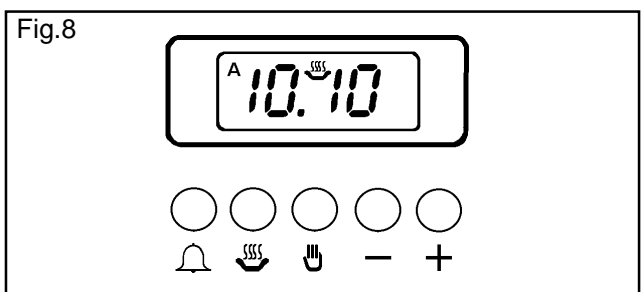
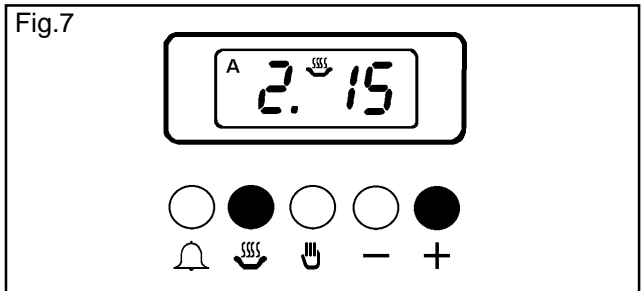
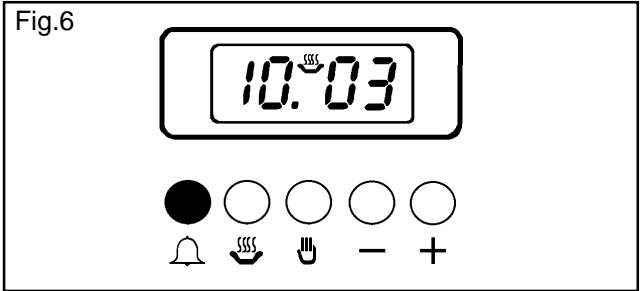
The display shows the time of day after a few seconds. The cookpot symbol will be lit. The oven will switch on again. Turn all oven controls off, no indicator neons are illuminated.



5. TO SET THE TIMER TO SWITCH OFF ONLY

- i) Set time of day e.g. 10.00.
- ii) Place food in oven.
- iii) Set length of cooking time. Within 5 seconds press () and (+) button until cooktime is displayed e.g. 2 hrs. 15 mins. The display will show as Fig.11, the auto symbol is lit, then reverts to time of day after a few seconds. Fig.12.
- iv) Set oven temperature and select Main or Second oven on the programmer button. If main oven is used select fan or conventional oven from main oven function switch. The oven neon and the function select neon will come on.
- v) To check the stop time press () and the stop time will be displayed, as Fig.13.

At the end of the cooktime, the Auto symbol will flash, an audible sound will be heard and the oven will switch off.



To cancel press () and () together. The oven will come back on again.

Fig.11

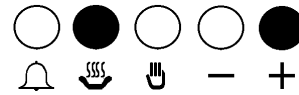
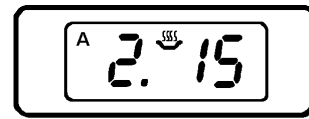

Fig.12

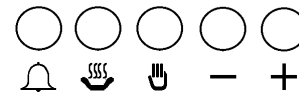
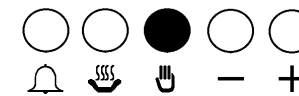
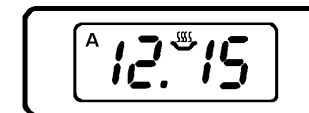

Fig.13



THE CERAMIC HOB

CAUTION: DO NOT USE THE COOKER IF THE CERAMIC GLASS IS DAMAGED. IF A FAULT OR CRACK BECOMES VISIBLE DURING COOKING, DISCONNECT THE COOKER IMMEDIATELY FROM THE ELECTRICITY SUPPLY AND CONTACT THE CUSTOMER SERVICE CENTRE.

USING THE HOTPLATES

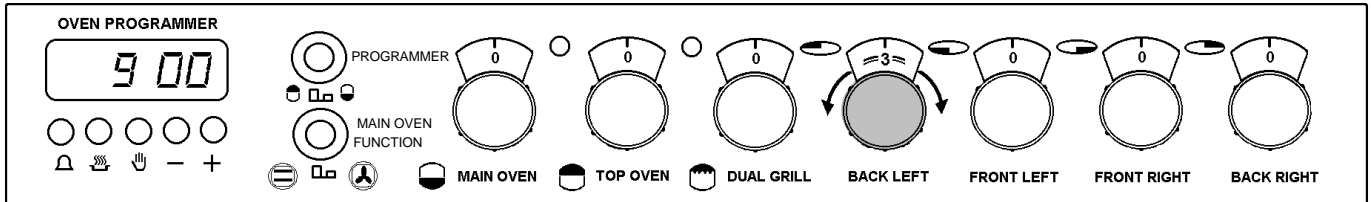

- To operate the dual hotplate, pop out and turn the control knob clockwise for the full area, or anti-clockwise for the centre section.
- The inner section is very economical when cooking with smaller diameter saucepans.
- For single hotplates, push in and turn the control knob in either direction to vary the heat setting. The highest number represents the hottest setting and the lowest represents the coolest setting. Choose a setting appropriate to the quantity and type of food to be cooked.
- This model has the added feature of Rapid Power Zone hotplates which react more quickly than the other ceramic hotplates and are easily identified by their instant red glow.

RECOMMENDED SAUCEPANS

For speed and economy only good quality saucepans with flat bases and close fitting lids are recommended. The saucepan base should be approximately the same size as the cooking area, a base diameter of up to 225mm (9in) may be used on a 180mm (7in) heated area.

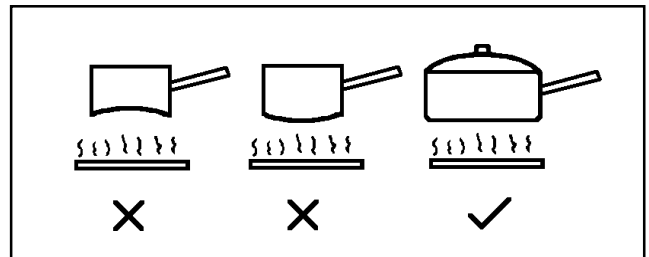

Ensure that new saucepans are well scrubbed to remove edges and take off any deposits left from manufacture.

Pressure cookers, preserving pans etc., should comply with the recommendations given above.

Traditional round bottomed Woks must not be used even with a stand. Woks with flat-bottomed bases are available and do comply with the above recommendations.

NOTE

Occasionally the heated areas may be seen to switch ON and OFF when higher heat settings are being used. This is due to a safety device which prevents the glass from overheating. Some switching ON and OFF when cooking at high temperatures, e.g. deep fat frying is quite normal, causes no damage to the hob and little delay in cooking times.

Excessive switching may however be caused by the use of an unsuitable saucepan or a saucepan which is smaller than the heated area. If excessive switching occurs, discontinue use of the saucepan.

HINTS AND TIPS

- Lift, rather than slide saucepans on and off the heated areas. This will reduce the risk of scratches and metal marks from saucepans with aluminium bases. Metal marks can be easily cleaned off providing they are not allowed to burn on.

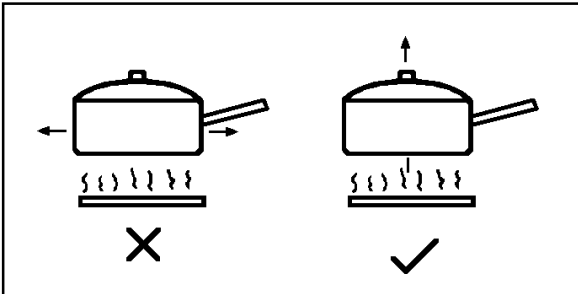

- Follow any guidelines provided by the saucepan manufacturer, particularly those relating to recommended heat settings.
- Avoid using thin badly dented or distorted saucepans. Those with uneven bases should not be used.

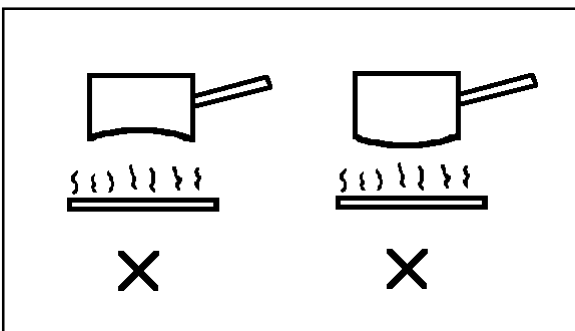

- To prolong the life of hotplates:-
 - Never use utensils with a skirt, e.g. a bucket.
 - Never use an asbestos mat.
 - Never leave the hotplates ON when not covered with a saucepan.
- Ensure that hob and saucepans are clean and dry before the start of cooking to reduce cleaning.
- Follow the cleaning instructions very closely to keep the hob looking like new.
- **If spillage occurs with sugar solutions, e.g. jams and syrups, it must be wiped from the hob before it sets and becomes hard otherwise damage to the hob will occur.**

HOT HOB INDICATOR

The ceramic hob is fitted with a hot hob indicator light which illuminates when the hob is too hot to touch. The light will go OFF when the hob has cooled.

DEEP FAT FRYING

SPECIAL FRYING NOTE:

For safety purposes when deep fat frying, fill the pan one-third full of oil, **DO NOT** cover the pan with a lid and **DO NOT** leave the pan unattended. In the unfortunate event of a fire, switch the cooker OFF at the electricity supply and cover the pan with a lid or damp cloth to assist in smothering the flames.

DO NOT use water on the fire. Leave the pan to cool for at least 30 minutes before moving it.

DO NOT leave the fat or oil in the frying pan on the hob to store it in case the hob is inadvertently switched ON.

1. Preparing the food

Seal the food by coating with flour, egg and breadcrumbs or batter. **Do not** use a basket with batter coated foods as they will stick.

2. Amount of oil

For safety purposes fill the pan only one-third full of oil.

3. Testing the temperature of the oil

It is advisable to use a thermometer to test the temperature of the oil. Alternatively, drop a small cube of bread into the oil which should brown in just under a minute if the oil is at the correct temperature of 190°C/375°F.

4. Cooking the food

Lower the food gently into the oil. **Do not** add too much food at once or the temperature of the oil will be reduced and may result in soggy, greasy food.

Turn the food if necessary; doughnuts float to the surface so will not brown on the upperside if not turned. Once cooked, drain the food on absorbent paper.

5. Double frying chips

Double frying will ensure good chips. First fry the chips for a few minutes at 170°C/340°F to seal the outside. Remove the chips from the oil. Increase the temperature of the oil to 190°C/375°F to finish cooking and brown the chips.

Chips may be kept for several hours after the first frying before finishing off with the second frying.

6. Frying temperatures

	Celsius Scale (°C)	Fahrenheit Scale (°F)
	150	300
First frying of potatoes	170	340
	175	350
	180	360
Second frying of potatoes	190	375
Frying chicken and fish	195	380
	200	390

PRESERVING

1. DO NOT use a pan that overlaps the perimeter of the hob trim.
2. To allow for a full rolling boil, the pan should be no more than one third full when all the ingredients have been added. It is better to use two pans rather than overfill one, or use half quantities.
3. Use firm fruit or vegetables and wash well before using.
4. Preserving sugar gives clear jam, however granulated sugar is cheaper and gives equally good flavour.
5. Crystallization may be caused if sugar is not completely dissolved before bringing jam to the boil. Over boiling will affect the flavour, setting properties and colour of the jam.

6. To test jam for setting:

If a jam thermometer is available, boil jam to 104°C. Marmalade should be boiled to 106°C.

If a jam thermometer is not available, remove pan from heat, place sample of jam on a cold dish and cool quickly (i.e. in a freezer or frozen food storage compartment of a refrigerator). When cold, it will crinkle and hold the mark of a finger run through it, if it is at setting point.

7. The scum should be removed as soon as possible from the surface of the preserve after setting point has been reached. Marmalade should be allowed to cool before potting to prevent the peel rising.

THE DUAL GRILL

USES OF THE DUAL GRILL

CAUTION - ACCESSIBLE PARTS MAY BECOME HOT WHEN THE GRILL IS IN USE. CHILDREN SHOULD BE KEPT AWAY.

The grill is a dual circuit grill which means that the full area of the grill can be used or alternatively the centre section only can be used for economy purposes when cooking smaller quantities of food.

SELECTING THE DUAL GRILL

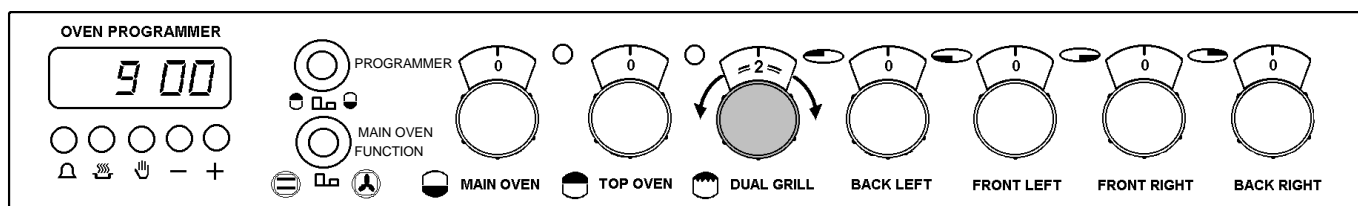

- To operate the dual grill pop out and turn the grill control clockwise for full area grilling and anti-clockwise for centre section grilling only.
- The highest number represents the hottest setting and the lowest the coolest setting.
- The cooling fan will operate in conjunction with the grill. For more details on the operation of the cooling fan see page 9.

NOTE

THE GRILL DOOR MUST BE LEFT OPEN DURING GRILLING.

The outer grill element may appear to glow slightly brighter than the inner element. This is quite normal.

The top oven cannot be operated when the grill is in use. If the grill and top oven controls are selected at the same time, only the top oven will operate.

THE GRILL PAN AND HANDLE

The grill pan is supplied with a removable handle.

To insert the handle, press the button on the handle with the thumb and pivot the handle slightly upwards inserting the lip into widest part of the bracket. Move the handle towards the left, lower into position and release the button.

Ensure the handle is positively located.

When removing the handle, press the button on the handle with the thumb and pivot the handle slightly upwards and towards the right to remove from the bracket.

Ensure your hand is protected when removing the grill pan handle as the grill element can become very hot.

ALWAYS REMOVE THE GRILL PAN HANDLE DURING GRILLING.

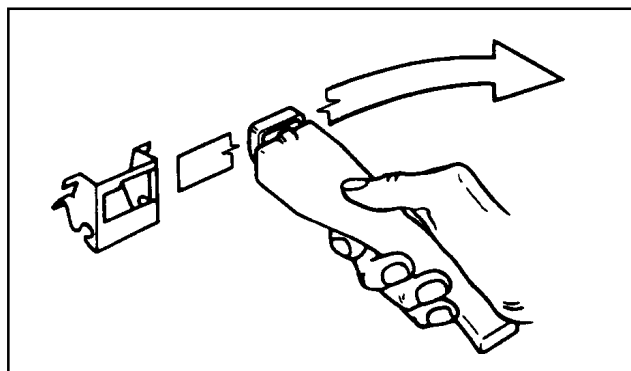

To correctly locate the grill pan on the shelf, ensure that the cut out on the underside of the handle bracket locates over the front bar of the shelf.

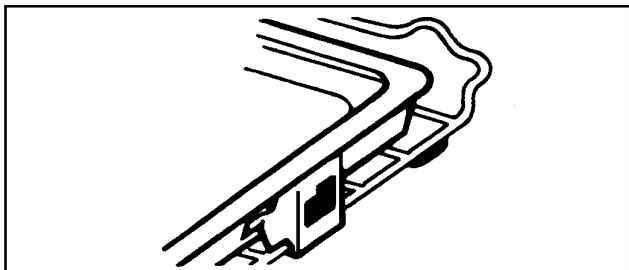

To check the progress of the food being grilled, the grill pan should be withdrawn on the shelf to attend to food during cooking or the carrier shelf can be lifted away from the cooker and rested on a heat resistant work surface.

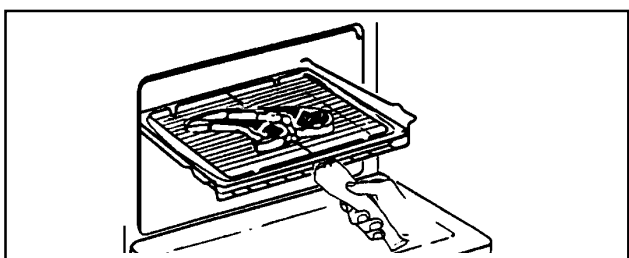

HINTS AND TIPS

- Food should be thoroughly dried before grilling to minimise splashing. Brush lean meats and fish lightly with a little oil or melted butter to keep them moist during cooking.
- Adjust the height of the grilling grid and grill pan runner position to allow for different foods.

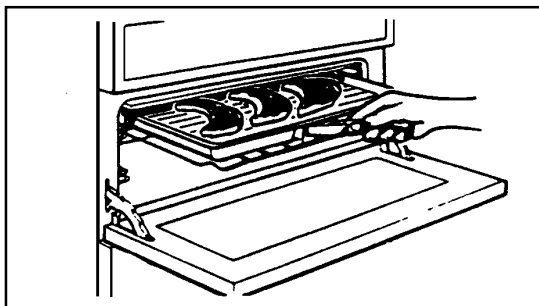

- The use of the trivet beneath the grid when grilling fatty food will keep fat splashing to a minimum.
- Place food on the grill pan grid in the grill pan or directly on the trivet in the grill pan.

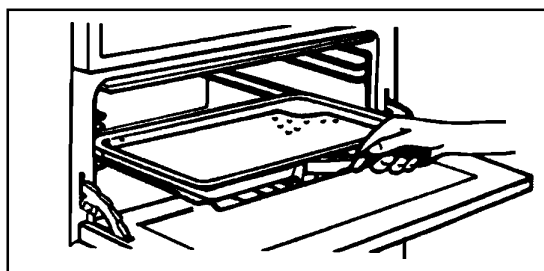

- Accompaniments such as tomatoes and mushrooms may be placed underneath the grid when grilling meats.

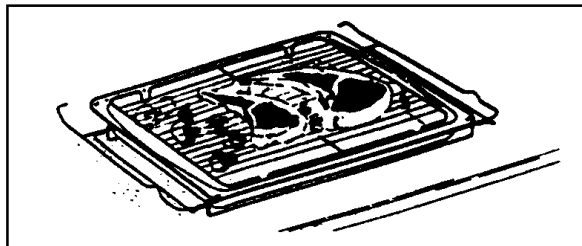

- When toasting bread use the cranked shelf in position 3 with the grid in the high position.
- Preheat the grill on a full setting for a few minutes before sealing steaks or toasting. Adjust the heat setting and the shelf as necessary during cooking.
- The food should be turned over during cooking as required.

GRILLING CHART

FOOD	SHELF	GRILL TIME (mins in total)
Bacon Rashers	Adjust	5-6
Beefburgers	shelf	10-15
Chicken Joints	position	30-40
Chops - Lamb Pork	and	15-20 20-30
Fish - Whole Trout/Mackerel	grill pan	15-25
Fillets - Plaice/Cod	grid	10-15
Kebabs	to	20-30
Kidneys - Lamb/Pig	suit	8-12
Liver - Lamb/Pig	different	10-20
Sausages	thicknesses	20-30
Steaks - Rare Medium Well Done	of food	6-12 12-16 14-20
Toasted Sandwiches		3-4

The times quoted above are given as a guide and should be adjusted to suit personal taste.



USES OF THE TOP OVEN

The top oven is the smaller of the two ovens. It is heated by elements in the top and bottom of the oven. It is designed for cooking on one level and for small quantities of food. It gives especially good results if used to cook fruit cakes, sweet or savoury flans or quiche.

The top oven is also ideal for use as a warming compartment to warm dishes and keep food hot. Use a temperature setting of 80 - 100°C on the top oven control dial.

SELECTING THE TOP OVEN

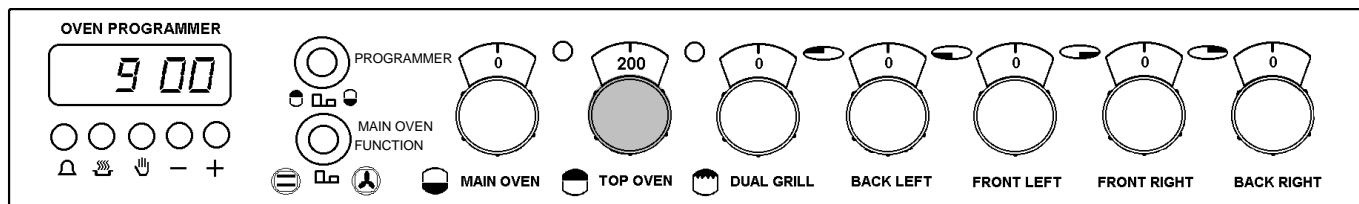

- Pop out and turn the top oven temperature control to the required setting.
- The cooling fan will operate immediately with the top oven. For more details on cooling fan operation see page 9.
- The top oven light will illuminate.

NOTE

1. The grill cannot be operated when the top oven is in use. If the grill and top oven controls are selected at the same time, only the top oven will operate.
2. The top oven neon indicator will glow until the oven has reached the desired temperature and then go out. It will then cycle ON and OFF showing that the oven temperature is being maintained.

TO FIT THE TOP OVEN SHELF

The shelf should be fitted with the straight rods uppermost on the frame and the forms towards the back of the oven. If not fitted correctly the anti-tilt and safety stop mechanism will be affected.

HINTS AND TIPS

- Most cooking should be carried out using an oven shelf positioned in one of the shelf runners.
- Single level cooking gives best results. If you require more than one level cooking use the fan or zoned oven functions.

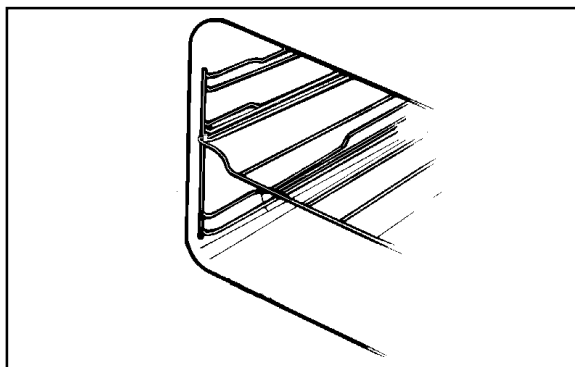

- Larger roasts and casseroles should normally be cooked in the main oven. However, they may be cooked on a flat shelf placed on the top oven base provided there is sufficient room for air circulation around the food.

- Stand dishes on a suitably sized baking tray on the shelf to prevent spillage onto the oven base and to help reduce cleaning.

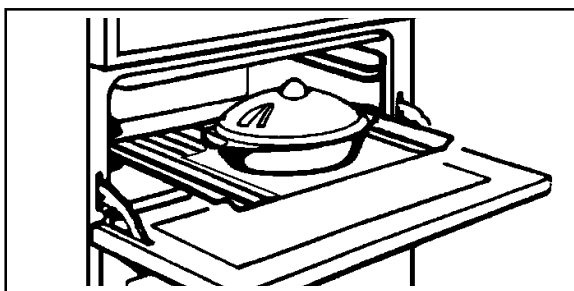

- There should always be at least 2.5cm (1") between the top of the food and the element. This gives best cooking results and allows room for rise in yeast mixtures, Yorkshire puddings etc.
- When cooking cakes, pastry, scones, bread etc., place the tins or baking trays centrally on a shelf directly below the element.

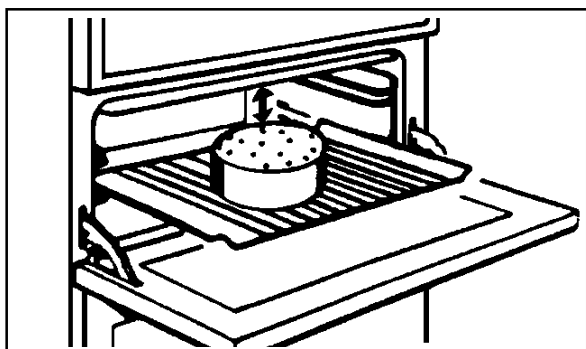

- DO NOT place dishes or baking trays directly onto the oven base as it becomes very hot and damage may occur.

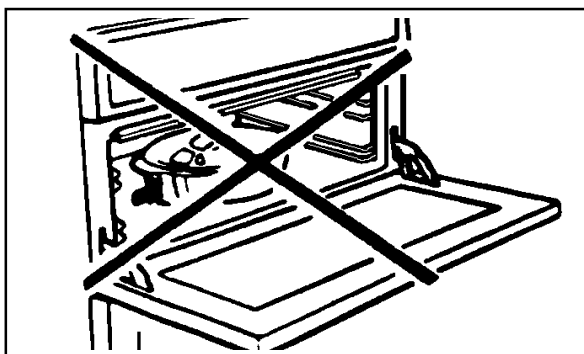

- The material and finish of the baking trays and dishes will affect the degree of base browning of the food. Enamelware, dark, heavy or non-stick utensils increase base browning. Shiny aluminium or polished steel trays reflect the heat away and give less base browning.
- DO NOT use the grill pan or meat tin as a baking tray as this will increase base browning of the food.

- Because of the smaller cooking space, lower temperatures and shorter cooking times are sometimes required. Be guided by the recommendations on page 22 and the recipes given in the cookbook supplied with the cooker.

- For economy leave the door open for the shortest possible time, particularly when placing food into a pre-heated oven.

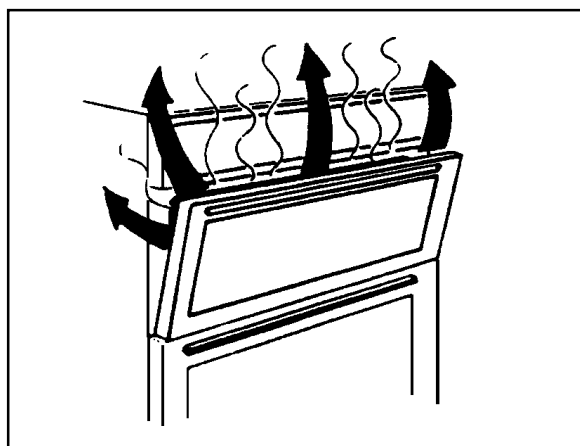

TOP OVEN COOKING CHART

The oven temperatures are intended as a guide only. It may be necessary to increase or decrease the temperature by 10°C to suit individual preference and requirements.

TOP OVEN		
FOOD	SHELF POSITIONS	COOKING TEMP °C
Biscuits	2 Crk	170-190
Bread	1 Crk*	200-220
Casseroles	1 Crk*	140-160
Cakes: Small and Queen	2 Crk	180-190
Sponges	2 Crk	160-170
Madeira	1 Crk	140-150
Rich Fruit	1 Crk	130-140
Christmas	1 Crk	130-140
Meringues	1 Crk	90-100
Fish	1 Crk	170-190
Fruit Pies and Crumbles	2 Crk	190-200
Milk Puddings	1 Crk	140-150
Pastry: Choux	1 Crk	200-210
Shortcrust	Depending on Dish	
Flaky		
Puff		
Plate Tarts	2 Crk	180-190
Quiches/Flan	1 Crk	170-180
Scones	1 Crk	220-230
Roasting: Meat and Poultry	1 Crk*	160-180

Crk = Cranked shelf

* or on a straight shelf on the oven base

Note: Shelf positions are counted from the bottom of the oven upwards.



USES OF THE FAN OVEN

The oven is heated by an element around the fan situated behind the back panel. The fan draws air from the oven and the element heats the air which circulates in the oven via the vents in the back panel. The advantages of fan oven cooking are:

PREHEATING

The fan oven quickly reaches its temperature, so it is not usually necessary to preheat the oven. Without preheating, however, you may find you need to add an extra 5 - 10 minutes on the recommended cooking times. For recipes needing high temperatures, e.g. bread, pastries, scones, soufflés etc., best results are achieved if the oven is preheated first.

COOKING TEMPERATURES

Fan oven cooking generally requires lower temperatures than conventional cooking. Follow the temperatures recommended in the chart on page 26. As a guide reduce temperatures by about 20°C-25°C for your own recipes.

BATCH BAKING

The fan oven cooks evenly on all shelf levels, especially useful when batch baking on three shelves.

SELECTING THE FAN OVEN

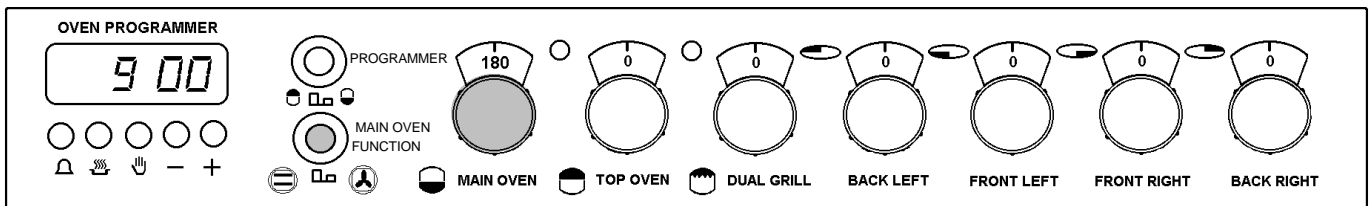

- Pop out and turn the main oven temperature control to the required setting.
- Pop in the main oven function button to select fan mode. The selected neon indicator will illuminate.

THINGS TO NOTE

1. The main oven neon indicator will glow until the oven has reached the desired temperature and then go out. It will cycle ON and OFF periodically during cooking showing that the temperature is being maintained.
2. The interior oven light will come ON when the temperature control is turned.

TO FIT THE MAIN OVEN SHELVES

The shelves should be fitted with the straight rods uppermost on the frame and the forms towards the back of the oven. If not fitted correctly the anti-tilt and safety stop mechanism will be affected.

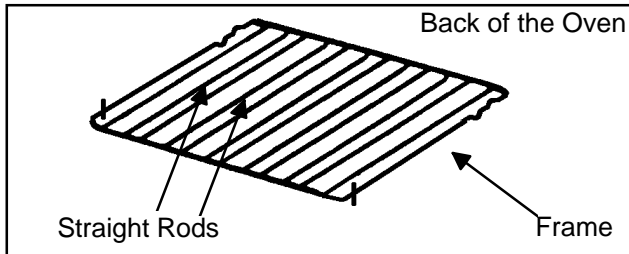

HINTS AND TIPS

- Arrange the shelves in the required positions before switching the oven ON. Shelves are numbered from the bottom upwards.

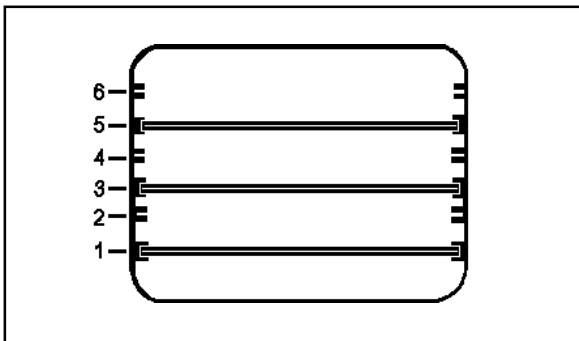

- When cooking more than one dish in the fan oven, place dishes centrally on different shelves rather than cluster several dishes on one shelf, this will allow the heat to circulate freely for the best cooking results.
- When batch baking one type of food, e.g. Victoria sandwich cakes, those of similar size will be cooked in the same time.
- It is possible to cook bulk loads on up to three shelves at any one time. The shelves are interchangeable between the top and main oven compartments.

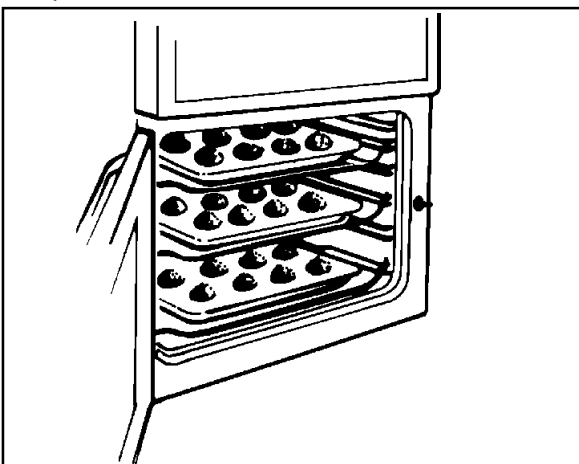

- It is recommended that when baking larger quantities, the shelf positions should be evenly spaced to suit the load being cooked. A slight increase in cooking time may be necessary.
- DO NOT place dishes or baking trays directly on the oven floor as it interferes with the oven air circulation and can lead to base burning; use the lower shelf position. However, non-critical dishes may be placed on the base when more space is required when using fanned mode only.
- The use of excessively high temperatures can cause uneven browning. It may be necessary to reduce temperatures slightly. Refer to the recommendations given in the oven cooking chart, see page 26.



USES OF THE CONVENTIONAL OVEN

This function uses the top and lower elements in the main oven to give single level cooking which is particularly suitable for dishes which require extra base browning such as pizzas, quiches and flans. Gratins, lasagnes and hotpots which require extra top browning also cook well in the conventional oven. This form of cooking gives you the opportunity to cook without the fan in operation.

SELECTING THE CONVENTIONAL OVEN

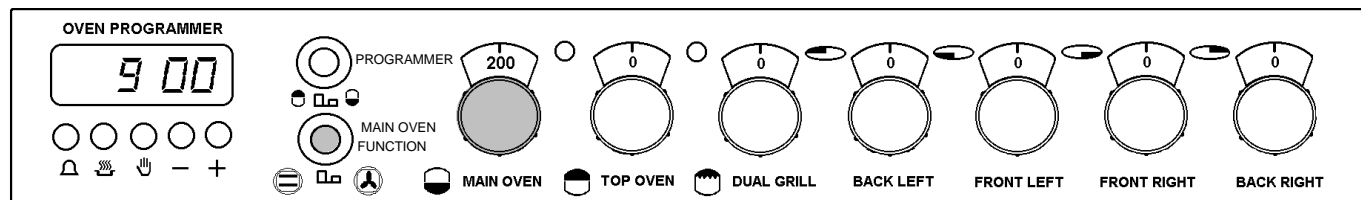

- Pop out and turn the main oven temperature control to the required setting.
- Pop out the main oven function button to select conventional mode. The selected neon indicator will illuminate.

THINGS TO NOTE

1. The oven indicator neon will glow until the oven has reached the desired temperature and then go out. It will cycle ON and OFF showing that the oven temperature is being maintained.
2. The internal oven light operates when the selector is set. If an automatic programme is set, the light will illuminate when the cook time begins.

HINTS AND TIPS

- The middle shelf position gives the best heat distribution. To increase base browning simply lower the shelf position. To increase top browning, raise the shelf level.

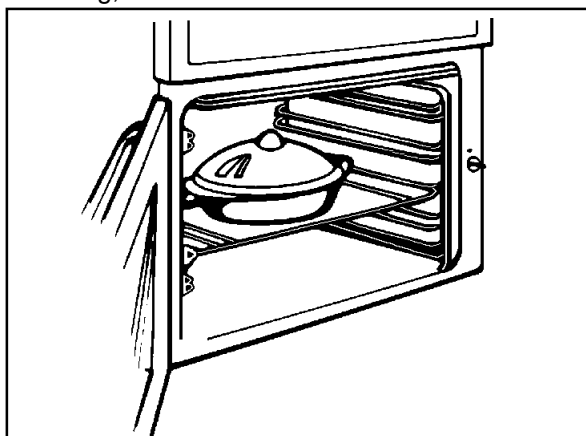

- The material and finish of the baking trays and dishes used will affect base browning. Enamelware, dark heavy or non-stick utensils increase base browning, while oven glassware, shiny aluminium or polished steel trays reflect the heat away and give less base browning.
- Always place dishes centrally on the shelf to ensure even browning.
- Stand dishes on suitably sized baking trays to prevent spillage on the base of the oven and make cleaning easier.
- Do not place dishes, tins or baking trays directly on the oven base as it becomes very hot and damage will occur. Use the lower runner position.

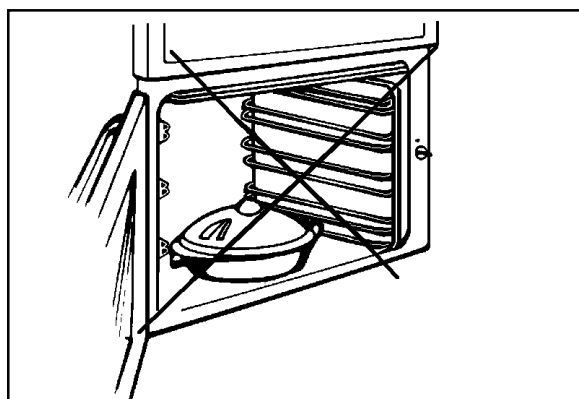

- For faster preheating use the fan oven function to preheat the oven until the oven indicator neon goes out, then switch the selector to the conventional oven setting.
- Single level cooking gives best results. If you require more than one level cooking use the fan or zoned oven functions.

MULTIFUNCTION OVEN COOKING CHART

The oven temperatures are intended as a guide only. It may be necessary to increase or decrease the temperatures by 10°C to suit individual preferences and requirements.

NOTE: Shelf positions are counted from the bottom of the oven.

Food	FAN OVEN		CONVENTIONAL OVEN	
	Shelf Position	Cooking Temp °C	Shelf Position	Cooking Temp °C
Biscuits		180-190	2 str.	180-190
Bread		210-220	2 str.	210-220
Casseroles	Shelf	130-140	2 str.	150-180
Cakes: Small & Queen	positions	160-170	2 str.	170-180
Sponges		160-170	2 str.	180-190
Madeira	are not	140-150	2 str.	160-170
Rich Fruit	critical	130-140	2 str.	150-160
Christmas		130-140	1 str.	130-140
Meringues	but ensure	90-100	2 str.	100-110
Fish	that oven	170-190	2 str.	170-190
Fruit Pies and Crumbles		190-200	2 str.	190-200
Milk Puddings	shelves are	130-140	3 crk.	130-140
Pastry: Choux	} evenly spaced when more than one is used		2 str.	160-170
Shortcrust				
Flaky			2 str.	190-200
Puff		190-200		
Plate Tarts		180-190	2 str.	190-200
Quiches/Flans		170-180	3 crk.	190-200
Scones		210-220	2 str.	230
Roasting: Meat and Poultry		160-180	2 str.	180-200

crk. = cranked shelf
str. = straight shelf

DEFROST FEATURE



USES OF DEFROST FEATURE

This main oven function defrosts most foods faster than more conventional methods. It is particularly suitable for delicate frozen foods which are to be served cold e.g. cream filled gateaux, cakes covered with icings or frostings, cheesecakes, biscuits, scones etc.

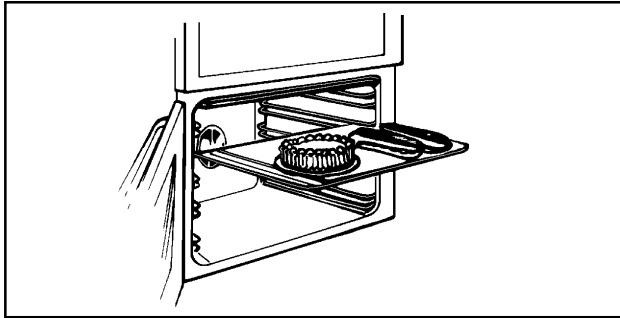

It is preferable to thaw fish, meat and poultry slowly in the fridge. However, this process can be accelerated by using the defrost function.

ALL JOINTS OF MEAT AND POULTRY MUST BE THAWED THOROUGHLY BEFORE COOKING.

ALWAYS COOK THOROUGHLY IMMEDIATELY AFTER THAWING.

Small or thin fish fillets, frozen peeled prawns, cubed or minced meat, liver, thin chops, steaks etc., can be thawed in 1 - 2 hours.

A 1kg/2¼lb oven ready chicken will be thawed in approximately 5 hours. Remove the giblets as soon as possible during the thawing process.

Joints of meat up to 2kg/4½lb in weight can be thawed using the defrost function.

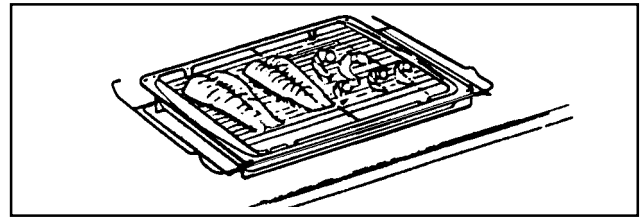

SELECTING DEFROST FEATURE

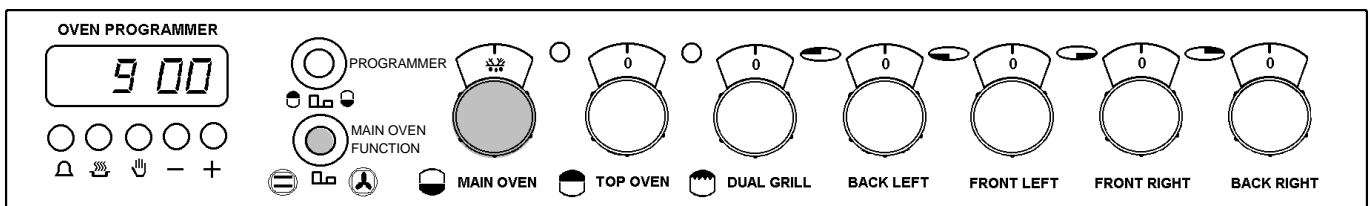

- Pop out and turn the fan oven temperature control to the defrost setting.
- Pop in the main oven function button to select Fan mode.
- When defrost is selected the oven indicator neon may come on. It will stay on until the oven reaches room temperature and then go off. It may cycle ON and OFF periodically during defrosting to maintain steady room temperature inside the oven.
- It may be necessary to turn the main oven control slightly beyond the defrost symbol until the oven light illuminates. If the oven indicator neon operates the control has been turned too far.

THINGS TO NOTE

1. The oven light will illuminate.
2. Care must always be taken when handling foods in the home. Always follow the basic rules of food hygiene to prevent bacterial and microbial growth and cross contamination when defrosting, preparing, cooking, cooling and freezing foods.

HINTS AND TIPS

- Place the frozen food in a single layer where possible and turn it over half way through the defrosting process.

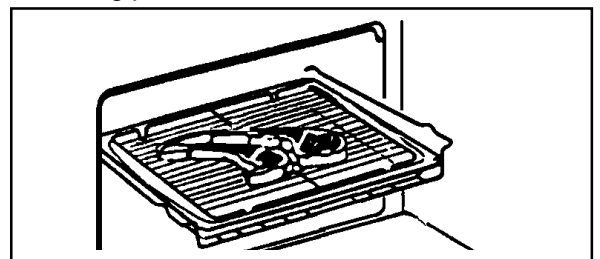

- The actual speed of defrosting is influenced by room temperature. On warm days defrosting will be faster than on cooler days.
- DO NOT leave food at room temperature once it is defrosted. Cook raw food immediately or store cooked food in the fridge.

CARE AND CLEANING

BEFORE CLEANING THE COOKER ALWAYS ALLOW THE COOLING FAN TO COOL THE COOKER DOWN BEFORE SWITCHING OFF THE ELECTRICITY SUPPLY.

CLEANING MATERIALS

Before using any cleaning materials on your cooker, check that they are suitable and that their use is recommended by the manufacturer.

Cleaners that contain bleach should NOT be used as they may dull the surface finishes. Harsh abrasives should also be avoided. Multi-surface anti bacterial products should not be used on the ceramic hob or on the surrounding trims.

CLEANING THE CERAMIC HOB

Make sure the ceramic glass is cool before cleaning. It is important to clean the ceramic hob daily to prevent soilage being burnt on.

Take care to avoid the hob trims when cleaning the ceramic glass as they may be damaged by the cleaning agents recommended.

DAILY CLEANING

Use the recommended Hob Brite Cleaner daily. If soilage is not allowed to burn on it will be much easier to clean off.

1. Apply a small amount of Hob Brite in the centre of each area to be cleaned.

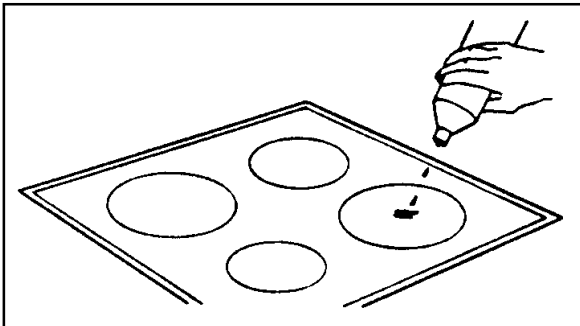

2. Dampen a clean paper towel or a plastic pad made specially for non-stick saucepans and rub vigorously until all marks are removed. This may take a few minutes.
3. Wipe off residues of cleaner with another damp paper towel and polish dry with a soft cloth.

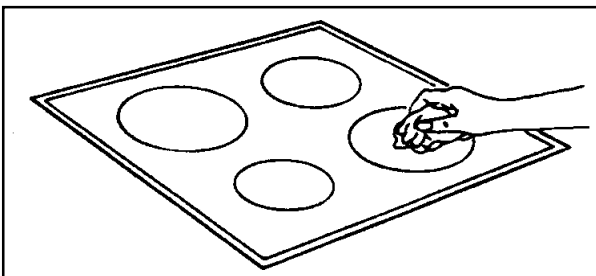

If Hob Brite is unavailable, one or more of the cleaning agents below may be used temporarily:

- a) Flash Cream Cleaner
- b) Jif Cream Cleaner
- c) Baking Soda

TO REMOVE MORE STUBBORN MARKS

1. Bar-Keepers Friend may be used to clean off more stubborn stains or to remove discolourations.

It may be necessary to rub the marks hard for several minutes.

2. Use a plastic pad specially for non-stick saucepans with Bar-Keepers Friend for removal of more stubborn soilage.

TO REMOVE BURNT ON SOILAGE

We strongly recommend the use of a Ceramic Hob Scraper (incorporating a single edge razor blade) to remove spillage on the hob, in particular sugar solutions, which if not removed can cause permanent damage. If required a Ceramic Hob Scraper can be purchased using the mail order form provided with the hob care kit.

1. Make sure the ceramic glass is cool.
2. Use a ceramic hob scraper at an angle of 30° to remove as much soilage as possible.
3. Use Bar-Keepers Friend or Hob Brite to finish off as directed above.

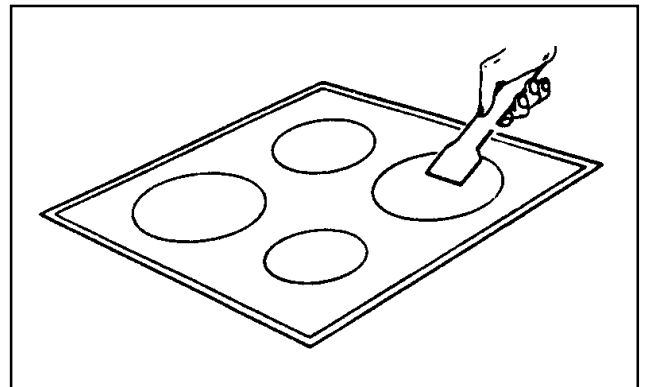

TO REMOVE DISCOLOURATIONS OR WHITE AND SILVER MARKS

These marks sometimes give the impression of being in or underneath the hob glass. They can almost always be removed provided they have not become excessively burnt on. Follow the instructions under 'To Remove more Stubborn Marks' above.

If this is unsuccessful, make up a paste of one part water to three parts Cream of Tartar and leave on the discoloured areas overnight. The marks should be easily removable the next day provided they have not been excessively burnt on. The paste should be thoroughly washed off afterwards.

HINTS AND TIPS

TO REDUCE HOB SOILAGE:

- Make sure the bottom of the saucepan and the cooking area are clean and dry before cooking begins.
- Ensure saucepans are large enough to accommodate food to avoid boil overs.
- If possible, wipe up spills and splatters as they occur, but take care to avoid steam burns.
- Avoid using a dishcloth or sponge to clean the hob. These may leave a layer of soiled detergent on the hob surface which will burn and discolour the next time the hob is used.
- Avoid the use of:
 - Household detergents and bleaches.
 - Impregnated plastic or nylon pads not described as suitable for non-stick saucepans.
 - Brillo pads, Ajax pads, steel wool pads.
 - Chemical oven cleaners, e.g. aerosols and oven pads.
 - Rust stain, bath and sink stain removers.
- **Any of the above products may cause damage to the hob.**
- It is dangerous to mix different cleaning products. The chemicals in them may react with each other with hazardous results.
- **SOILAGE FROM SUGAR SOLUTIONS MUST BE REMOVED FROM THE HOB BEFORE THE SYRUP HAS SET OTHERWISE DAMAGE TO THE HOB SURFACE WILL OCCUR.**
- Avoid placing plastic items, aluminium foil or dishes on the hot surface as this will cause damage to the hob.

CLEANING THE OUTSIDE OF THE COOKER

DO NOT use abrasive cleaning materials or scourers on the outside of the cooker as some of the finishes are painted and damage may occur. Regularly wipe over the control panel, oven doors and cooker sides using a soft cloth and liquid detergent.

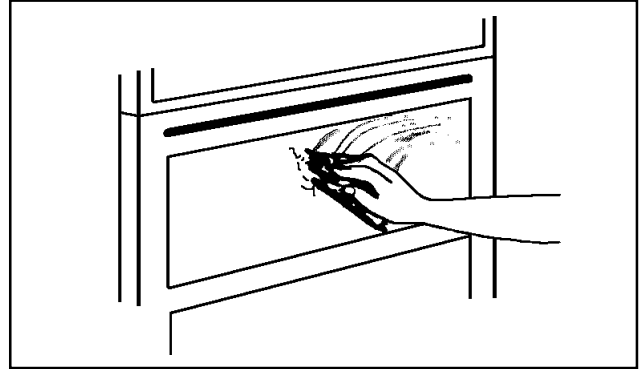

DO NOT ATTEMPT TO REMOVE ANY OF THE CONTROL KNOBS FROM THE PANEL AS THIS MAY CAUSE DAMAGE AND IS A SAFETY HAZARD.

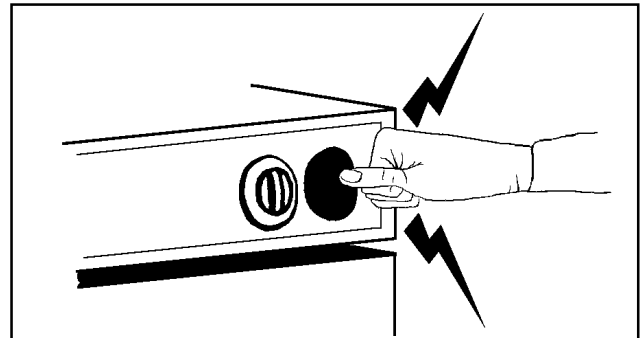

REMOVING AND REPLACING WIREWORK SIDE RUNNERS

Remove all shelves and furniture from the oven. Hold the bottom of the wirework runners and draw the runners towards the centre of the oven. Unhook from the top and remove.

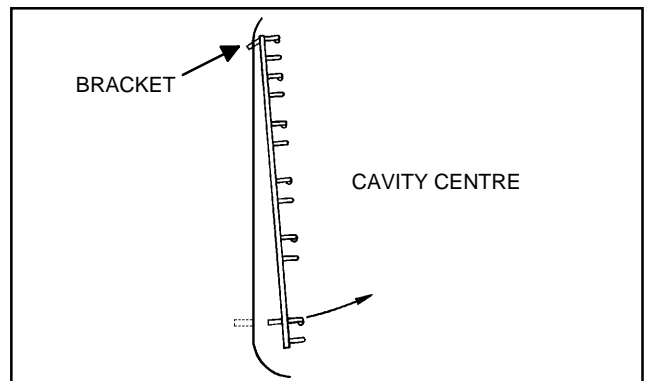

Clean the wirework runners by soaking in very hot soapy water, mild abrasives may be used.

To replace, hook the wirework side runner into the cavity, slide back and press into place. Ensure the wirework runners are firmly in position before replacing the oven shelves.

CLEANING THE GRILL DEFLECTOR, GRILL PAN, GRILL PAN GRID, OVEN SHELVES AND WIREWORK SIDE RUNNERS

All removable parts are dishwasher safe. Alternatively, soak them in hot soapy water if they are heavily soiled they will then clean more easily.

The grill deflector, grill pan, meat tin and trivet can be cleaned using a soap impregnated steel wool pad. The grill pan grid, oven shelves and wirework side runners should be cleaned using hot soapy water. Soaking first will make cleaning easier.

NOTE: The grill pan handle should not be cleaned in the dishwasher.

CLEANING INSIDE THE OVEN/GRILL COMPARTMENTS

The main and second oven compartments are coated with a Stayclean finish.

The Stayclean surfaces inside the ovens should not be cleaned manually. See Page 31 'Care of Stayclean Surfaces'.

The vitreous enamel oven base can be cleaned using normal oven cleaners or aerosol oven cleaners with care. Ensure that the manufacturers instructions are followed and that all parts are well rinsed afterwards.

Aerosol cleaners must not be used on Stayclean surfaces and must not come into contact with the elements or the door seal as this may cause damage.

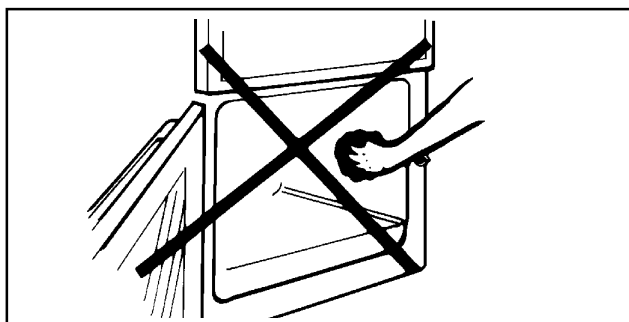

CLEANING BETWEEN THE OUTER AND INNER DOOR GLASS

The outer door glass is removable for cleaning.

TO REMOVE THE OUTER GLASS

1. Open the oven door slightly to gain access to the two cross head screws on the top of the oven door.

2. Loosen the two screws using a Pozidrive screwdriver.
3. Hold the door glass securely in place with one hand before removing the screws completely with the other hand.
4. Using both hands, gently tilt the top of the door glass towards you. Lift slightly to disengage the locators from the two bottom brackets.

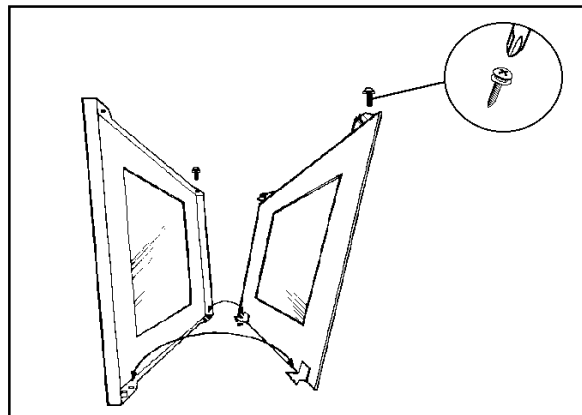

5. Clean the outer and inner glass using hot soapy water or Hob Brite cleaner may be used. DO NOT try to clean the aluminium foil which is inside the door. The foil is there to help keep the door cool, if it is damaged it will not work. Ensure that all parts are well rinsed and thoroughly dry before attempting to replace the outer door.

TO REPLACE THE OUTER GLASS

1. Holding the oven glass with both hands, gently place the locators into the holes of the brackets at the bottom of the oven door.
2. Push the top of the oven glass towards the oven door, ensuring the screw location holes line up.
3. Hold the glass in place with one hand and insert the cross head screws into the location holes with the other hand. Give the screws one turn to ensure the glass is secure.
4. Tighten the screws positively with a Pozidrive screwdriver before closing the oven door.

Do not attempt to use the oven without the glass being in place.

TO CLEAN INSIDE THE INNER GLASS DOOR

The inner glass door is not removable. Clean using hot soapy water or Hob Brite Cleaner and a soft cloth. Take care NOT to use abrasives as they damage the glass or seal.

CARE OF STAYCLEAN SURFACES

Stayclean surfaces destroy splashes of food and fats when the oven temperature is raised to around 220°C.

It is a good idea to run the oven for an hour or two per week to ensure continued good performance from the Stayclean finish.

DO use the trivet in the roasting tin. During roasting the fat from the trivet will be contained beneath the trivet and therefore prevent it from splashing onto the Stayclean finish.

HINTS AND TIPS

- Manual cleaning of Stayclean is not recommended. Damage will occur if oven sprays or abrasives of any kind are used.

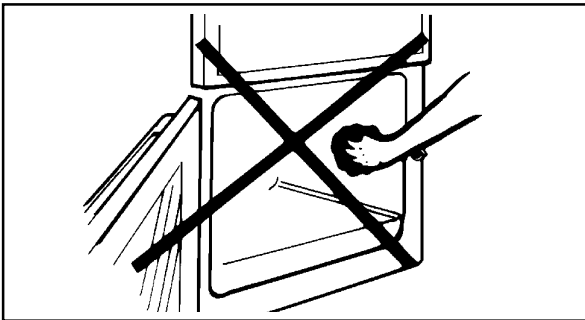

- Slight discolouration and polishing of the Stayclean surface may occur in time. This DOES NOT affect the Stayclean properties in any way.
- A good time to allow the oven to run on is after the weekly roast. After removing the roast, turn the oven up to 220°C and allow to run for an hour or so. It is important NOT to allow a build-up of soilage as this can prevent the Stayclean from working.
- Follow the recommendations below to keep oven soilage to a minimum.
- Cook at the recommended temperatures. Higher temperatures during roasting will increase soilage. Try cooking at lower temperatures for an increased length of time, you will save energy and often the joint is more tender.
- Use minimal, if any, extra oil or fat when roasting meat, potatoes only require brushing with fat before cooking. Extra fat in the oven during roasting will increase splashing and soilage.
- It is NOT necessary to add water to the meat tin when roasting. The water and the fat juices from the joint create excessive splattering during cooking - even at normal temperatures, as well as causing condensation.

- Covering joints during cooking will also prevent splashing onto the interior surfaces. Removing the covering for the last 20-30 minutes will allow extra browning if required. Some large joints and turkeys especially benefit by this method of cooking, allowing the joint to cook through before the outside is overbrowned.

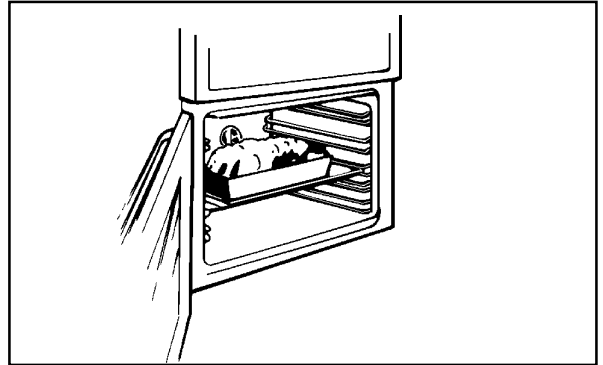

REPLACING THE OVEN LIGHT BULB

The type of bulb required is a 300C 25 watt small Edison Screw. Part number 572 491 5431-00/1. (Available through Tricity Bendix service centres).

CAUTION: Disconnect the appliance from the electricity supply before replacing the bulb.

Open door and remove the shelves and wirework runners to enable easy access to the oven light assembly. Insert a flat blade screwdriver between the oven side and the glass which covers the bulb.

Support the glass with your hand and prise out sufficiently to release the glass cover. Unscrew the bulb in an anticlockwise direction until it is possible to remove the bulb with ease.

Fit the new bulb by turning in a clockwise direction until it is secure. Ensuring the indent to the flange is pointing to the rear of the oven, replace the glass by pushing it firmly into the hole to cover the bulb assembly.

Replace the shelves. Restore the electricity supply and adjust the time of day and clock as necessary.

SOMETHING NOT WORKING?

We strongly recommend that you carry out the following checks on your cooker before calling a Service Engineer. It may be that the problem is a simple one which you can solve yourself without the expense of a service call.

If our Service Engineer finds that the problem is listed below you will be charged for the call whether or not the cooker is under guarantee.

The cooker does not work at all:

- * Check that the cooker has been wired in and is switched on at the wall.
- * Check that the main cooker fuse is working.
- * Check that the timer is set to manual (see page 13).

The grill and hotplates work but the oven does not:

- * Check that the timer is set to manual operation (see page 13).

The oven temperature is too high or low:

- * Check that the recommended temperatures are being used (see pages 22 and 26). Be prepared to adjust up or down 10°C to achieve the result you want.

The hotplates and main oven work but the grill does not:

- * Check that you have carefully followed the instructions for operation of the grill.
- * If the cooling fan fails the grill will not operate.
Please call your Customer Service Centre.

If the oven is not cooking evenly or the side opening door will not stay open:

- * Check that the cooker is level.

The oven light fails to illuminate:

- * Check that the cooker is not set for automatic cooking. The light will illuminate when the cooktime begins.
- * If you have had your cooker for several months you may need to replace the oven light bulb, see page 31.

The oven fan is noisy:

- * Check that the oven is level.
- * Check that the bakeware and shelves are not vibrating in contact with the back panel in the oven.

HELP US TO HELP YOU

Please determine your type of enquiry before writing or telephoning.

SERVICE

It is a recommendation by the manufacturer that annual servicing of the product is done by the manufacturers approved service organisation.

In the event of your appliance requiring service, or if you wish to purchase spare parts please contact your local Tricity Bendix Service Force Centre by telephoning:

0990 929929

The address of your local Service Force Centre is detailed on the following pages headed Tricity Bendix Service Force.

Before calling out an engineer, please ensure you have read the details under the heading 'Something Not Working?' and have the model number and purchase date to hand.

Please note that all enquiries concerning service should be addressed to your local Service Centre.

CUSTOMER CARE DEPARTMENT

For general enquiries concerning your Tricity Bendix cooker or for further information on Tricity Bendix products, you are invited to contact our Customer Care Department by letter or telephone as follows:

Customer Care Department
Tricity Bendix
PO Box 47
Newbury
Berkshire
RG14 5XL

Tel: (01635) 525542

To contact your local Tricity Bendix Service Centre telephone 0990 929929

CHANNEL ISLANDS

GUERNSEY Guernsey Electricity
PO Box 4
Vale, Guernsey
Channel Islands

JERSEY Jersey Electricity
Company
PO Box 45
Queens Road
St Helier
Jersey
Channel Islands
JE4 8NY

SCOTLAND

ABERDEEN 8 Cornhill Arcade
(M05) Cornhill Drive
Aberdeen
AB2 5UT

AUCHTERMUCHY 33A Burnside
(M03) Auchtermuchy
Fife
KY14 7AJ

BLANTYRE Unit 5
(M07) Block 2
Auchenraith Ind Estate
Rosendale Way
Blantyre
G72 0NJ

DUMFRIES 93 Irish Street
(M01) Dumfries
Scotland
DG1 2PQ

DUNOON Briar Hill
(M67) 7 Hill Street,
Dunoon
Argyll
PA23 7AL

GLASGOW 20 Cunningham Road
(M04) Clyde Estate
Rutherglen,
Glasgow,
G73 1PP

INVERNESS Unit 3B
(M06) Smithton Indust. Est.
Smithton
Inverness
IV1 AJ

ISLE OF ARRAN Arran Domestics
(M01) Unit 4 The Douglas
Centre
Brodick
(OWN SALES) Isle of Arran
KA27 8AJ

ISLE OF BARRA J Zerfah
(M01) 244 Bruernish
Isle of Barra
(OWN SALES) Western Islands
HS9 5QY

ISLE OF BUTE Walker Engineering
(M66) Glenmhor
Upper Serpentine Road
Rothesay
Isle of Bute
PA20 9EH

ISLE OF LEWIS ND Macleod
(M69) 16 James Street
Stornoway
Isle of Lewis PA87 2QW

ISLE OF MULL Brian Hogg
(M68) Braeside
Raeric Road
Tobermory
Isle of Mull PA75 6PU

KELSO 2-8 Wood Market
(M08) Kelso
Borders TD5 7AX

ORKNEY Corsie Domestics
(M65) 7 King Street
Kirkwall
Orkney KW15

SHETLAND Tait Electronic Systems
Ltd.
Holmsgarth Road
Lerwick
(OWN SALES) Shetland ZE1 0PW

SHETLAND Bolts Shetland Ltd
26 North Road
Lerwick
(OWN SALES) Shetland ZE1 0PE

WHALSAY Leask Electrical
Harisdale
Symbister, Whalsay
(OWN SALES) Shetland ZE2 9AA

NORTHERN IRELAND

BELFAST Owenmore House
(M27) Kilwee Industrial Estate
Upper Dunmury Lane
Belfast
BT17 0HD

WALES

CARDIFF Guardian Industrial
(M28) Estate
Clydesmuir Road
Tremorfa, Cardiff
CF2 2QS

CLYWD Unit 6-7 Coed - Parc
(M14) Abergele Road
Rhuddlan
Clywd
Wales
LL18 5UG

OSWESTRY Plas Funnon Warehouse
(M17) Middleton Road
Oswestry
SY11 2PP

NORTH EAST

GATESHEAD Unit 356a
(M39) Dukesway Court
Dukesway
Team Valley
Gateshead
NE11 0BH

GRIMSBY Unit 2
(M42) Cromwell Road
Grimsby
South Humberside
DN31 2BN

HULL Unit 1
(M41) Boulevard Industrial
Estate
Hull
HU3 4AY

LEEDS 64-66 Cross Gates Road
(M37) Leeds
LS15 7NN

NEWTON AYCLIFFE Unit 16
(M45) Gurney Way
Aycliffe Ind Estate
Newton Aycliffe
DL5 6UJ

SHEFFIELD Pennine House
(M38) Roman Ridge Ind.
Roman Ridge Road
Sheffield
S9 1GB

NORTH WEST

BIRKENHEAD 1 Kelvin Park
(M11) Dock Road
Birkenhead
L41 1LT

CARLISLE Unit 8
(M10) South John Street
Carlisle
CA2 5AJ

ISLE OF MAN South Quay Ind Estate
(M64) Douglas
Isle of Man

LIVERPOOL Unit 1
(M15) Honeys Green Precinct
Honeys Green Lane
Liverpool
L12 9JH

MANCHESTER Unit 30, Oakhill Trading
(M09) Estate
Devonshire Road
Worsley
Manchester
M28 3PT

PRESTON Unit 250
(M13) Dawson Place
Walton Summit
Bamber Bridge
Preston
Lancashire
PR5 8AL

STOCKPORT Unit 20 Haigh Park
(M16) Haigh Avenue
Stockport
SK4 1QR

To contact your local Tricity Bendix Service Centre telephone 0990 929929

MIDLANDS

BIRMINGHAM (M18)	66 Birch Road East, Wyrley Road Industrial Estate Witton Birmingham B6 7DB
BOURNE (M44)	Manning Road Ind Estate Pinfold Road Bourne PE10 9HT
BRIDGNORTH (M72)	1 Underhill Street Bridgnorth Salop WV16 4BB
GLOUCESTER (M23)	101 Rycroft Street Gloucester GL1 4NB
HEREFORD (M31)	Unit 3 Bank Buildings Cattle Market Hereford HE4 9HX
HIGHAMFERRERS (M51)	The Old Barn Westfield Terrace Higham Ferrers NN10 8BB
ILKESTON (M43)	Unit 2 Furnace Road Ilkeston DE7 5EP
LEICESTER (M22)	Unit 23-24 Alliance Business Pk Townsend Drive Nuneaton Warwickshire CV11 6RX
LINCOLN (M40)	Unit 8 Stonefield Park Clifton Street Lincoln LN5 8AA
NEWCASTLE UNDER LYME (M12)	18-21 Croft Road Brampton Industrial Estate Newcastle under Lyme Staffordshire ST5 0TW
NUNEATON (M21)	19 Ptarmigan Place Townsend Drive Nuneaton CV11 6RX
REDDITCH (M20)	Heming Road Washford Redditch Worcestershire B98 0DH
TAMWORTH (M19)	Unit 3 Sterling Park Claymore Tamworth B77 5DO
WORCESTER (M73)	Unit 1 Northbrook Close Gregorys Mill Ind Estate Worcester WR3 8BP

LONDON & EAST ANGLIA

CANVEY ISLAND	2-4 Sandhurst Kings Road Canvey Island SS8 0QY
CHELMSFORD (M47)	Hanbury Road Widford Ind Estate Chelmsford Essex CM12 3AE
COLINDALE (M53)	Unit 14 Capital Park Capital Way Colindale London NW9 0EQ
ENFIELD (M49)	284 Alma Road Enfield London EN3 7BB
GRAVESEND (M57)	Unit B4, Imperial Business Estate Gravesend Kent DA11 0DL
HARPENDEN (M46)	Unit 4 Riverside Estate Coldharbour Lane Harpenden AL5 4UN
LETCHEWORTH (M50)	16-17 Woodside Ind Est. Works Road Letchworth Herts SG6 1LA
MAIDENHEAD (M60)	Reform Road Maidenhead Berkshire SL6 8BY
MOLESEY (M61)	10 Island Farm Avenue West Molesey Surrey KT8 2UZ
NEWBURY (M24)	PO Box 5627 Newbury Berkshire RG14 5GF
IPSWICH (M48)	Unit 2B Elton Park Business Centre Hadleigh Road Ipswich IP2 0DD
NORWICH (M52)	2b Trafalgar Street Norwich NR1 3HN
SUNBURY (M63)	Unit 1a The Summit Hanworth Road Hanworth Ind Estate Sunbury on Thames TW16 5D
SYDENHAM (M62)	Unit 6 Metro Centre Kangley Bridge Road Sydenham SE26

SOUTH EAST

ASHFORD (M58)	Unit 2 Bridge Road Business Estate Bridge Road Ashford Kent TN2 1BB
FLEET (M59)	Unit 1 Redfields Industrial Estate Church Crookham Fleet Hampshire GU13 0RD
HAYWARDS HEATH (M55)	21-25 Bridge Road Haywards Heath Sussex RH16 1UA
TONBRIDGE (M56)	Unit 30 Deacon Trading Estate Morley Road Tonbridge Kent TN9 1RA

SOUTH WEST

BARNSTAPLE (M30)	P.O. Box 12 Barnstaple North Devon EX31 2YB
BOURNEMOUTH (M26)	63-65 Curzon Road Bournemouth Dorset BH1 4PW
BRIDGEWATER (M35)	6 Hamp Industrial Estate Bridgewater Somerset TA6 3NT
BRISTOL (M25)	11 Eldon Way Eldonwall Trading Bristol Avon BS4 3QQ
EMSWORTH (M33)	266 Main Road Southbourne Emsworth PO10 8JL
ISLE OF WIGHT (M34)	Unit 8 Enterprise Court Ryde Business Park Ryde Isle of Wight PO33 1DB
NEWTON ABBOT (M29)	Unit 2 Zealley Industrial Estate Kingsteignton Newton Abbot S. Devon TQ12 3TD
PLYMOUTH (M32)	16 Faraday Mill Cattledown Plymouth PL4 0ST
REDRUTH (M36)	Unit 7D Pool Industrial Estate Wilson Way, Redruth, Cornwall TR15 3QW

GUARANTEE CONDITIONS

Standard guarantee conditions

We, Tricity Bendix, undertake that if within 12 months of the date of the purchase this Tricity Bendix appliance or any part thereof is proved to be defective by reason only of faulty workmanship or materials, we will, at our option repair or replace the same FREE OF CHARGE for labour, materials or carriage on condition that:

- The appliance has been correctly installed and used only on the electricity supply stated on the rating plate.
- The appliance has been used for normal domestic purposes only, and in accordance with the manufacturer's instructions.
- The appliance has not been serviced, maintained, repaired, taken apart or tampered with by any person not authorised by us.
- All service work under this guarantee must be undertaken by a Tricity Bendix service centre.
- Any appliance or defective part replaced shall become the Company's property.
- This guarantee is in addition to your statutory and other legal rights.

Home visits are made between **8.30am** and **5.30pm** Monday to Friday. Visits may be available outside these hours in which case a **premium** will be charged.

Exclusions

This guarantee does not cover:

- Damage or calls resulting from transportation, improper use or neglect, the replacement of any light bulbs or removable parts of glass or plastic.
- Costs incurred for calls to put right an appliance which is improperly installed or calls to appliances outside the United Kingdom.
- Appliances found to be in use within a commercial environment, plus those which are subject to rental agreements.
- Products of Tricity Bendix manufacture which are not marketed by Tricity Bendix.

European Guarantee

If you should move to another country within Europe then your guarantee moves with you to your new home subject to the following qualifications:

- The guarantee starts from the date you first purchased your product.
- The guarantee is for the same period and to the same extent for labour and parts as exists in the new country of use for this brand or range of products.
- This guarantee relates to you and cannot be transferred to another user.
- Your new home is within the European Community (EC) or European Free Trade Area.
- The product is installed and used in accordance with our instructions and is only used domestically, i.e. a normal household.
- The product is installed taking into account regulations in your new country.

Before you move please contact your nearest Customer Care centre, listed below, to give them details of your new home. They will then ensure that the local Service Organisation is aware of your move and able to look after you and your appliances.

France	Senlis	+33 (0)3 44 62 28 28
Germany	Nurnberg	+49 (0)911 323 2600
Italy	Pordenone	+39 (0)1678 47053
Sweden	Stockholm	+46 (0)20 78 77 50
UK	Newbury	+44 (0)1635 525 542

RATING PLATE REFERENCE

MAKE AND MODEL NO.	PRODUCT NO.	SERIAL NO.	DATE OF PURCHASE

IMPORTANT NOTICE

In line with our continuing policy of research and development, we reserve the right to alter models and specifications without prior notice.

This handbook is accurate at the date of printing, but will be superseded and should be disregarded if specifications or appearance are changed.



TRICITY BENDIX, PO BOX 47, NEWBURY, BERKSHIRE, RG14 5XL
TELEPHONE (01635) 525542

MODEL NO.
SI 535



PART NO.
311352301

Free Manuals Download Website

<http://myh66.com>

<http://usermanuals.us>

<http://www.somanuals.com>

<http://www.4manuals.cc>

<http://www.manual-lib.com>

<http://www.404manual.com>

<http://www.luxmanual.com>

<http://aubethermostatmanual.com>

Golf course search by state

<http://golfingnear.com>

Email search by domain

<http://emailbydomain.com>

Auto manuals search

<http://auto.somanuals.com>

TV manuals search

<http://tv.somanuals.com>