



# OPERATING AND INSTALLATION INSTRUCTIONS

MODEL NO.  
**SIE 505 SSE/BZ**

## TECHNICAL DETAILS

### MODEL NO. SIE 505 SSE/BZ

Voltage: 230/240 Volts AC 50Hz

Wattage: 10.5/11.4 kW

Height: 900mm

Width: 600mm

Depth: 598mm

This appliance complies with: European Council Directive 73/23/EEC.  
EMC Directive 89/336/EEC.  
CE Marking Directive 93/68/EEC.

# CONTENTS

<b>Technical Details</b> .....	2
<b>Contents</b> .....	3
<b>Preface</b> .....	5
<b>Safety</b> .....	6
Before Installation .....	6
During Operation .....	6
After Use .....	7
General .....	7
<b>Introduction</b> .....	8
Rating Plate .....	8
Installation .....	8
General Notes on Using Your Cooker .....	9
About Condensation and Steam .....	9
The Cooling Fan for the Controls .....	9
Control Panel Indicator Neons .....	9
Cookware .....	9
Grill and Oven Furniture .....	10
<b>Getting to Know your Cooker</b> .....	11
The Control Panel .....	11
The Timer .....	12
<b>The Ceramic Hob</b> .....	14
Recommended Saucepans .....	14
Hints and Tips .....	14
Hot Hob Indicator .....	15
Deep Fat Frying .....	15
Preserving .....	15
<b>The Grill</b> .....	16
Uses of the Dual Grill .....	16
Selecting the Grill .....	16
Things to Note .....	16
The Grill Pan and Handle .....	16
Hints and Tips .....	17
Grilling Chart .....	17
<b>The Top Oven</b> .....	18
Uses of the Top Oven .....	18
Selecting the Top Oven .....	18
Things to Note .....	18
To Fit the Top Oven Shelf .....	18
Hints and Tips .....	19
<b>The Main Fan Oven</b> .....	20
Uses of the Fan Oven .....	20
Selecting the Fan Oven .....	20
Things to Note .....	20
To Fit the Main Oven Shelves .....	20
Hints and Tips .....	21
<b>Oven Cooking Chart</b> .....	22
<b>Roasting Chart</b> .....	23

# CONTENTS

<b>Defrosting</b> .....	24
Uses of Defrost Feature .....	24
Selecting Defrost .....	24
Things to Note .....	24
Hints and Tips .....	24
<b>Care and Cleaning</b> .....	25
Cleaning Materials .....	25
Cleaning the Brass Plated Handles .....	25
Cleaning the Ceramic Hob .....	25
Hints and Tips .....	26
Cleaning the Outside of the Cooker .....	26
Cleaning the Grill Deflector, Grill Pan, Grill Pan Grid and Oven Shelves .....	26
Cleaning Inside the Oven and Grill Compartments .....	26
Care of Stayclean Surfaces .....	27
Hints and Tips .....	27
Cleaning between the Outer and Inner Door Glass .....	27
Replacing the Oven Light Bulb .....	28
<b>Something Not Working?</b> .....	29
<b>Service and Spare Parts</b> .....	30
<b>Customer Service Centres</b> .....	31
<b>Guarantee Conditions</b> .....	33

## PREFACE

Dear Customer,

Thank you for buying a Tricity Bendix cooker. With our 80 years experience in developing and manufacturing the very best in U.K. cookers, you can be assured that you have purchased a hard working, reliable, quality product.

Tricity Bendix cookers comply with British Standard safety and performance requirements. They have been approved by BEAB (British Electrotechnical Approvals Board) and are covered by a 12 month parts and labour guarantee.

To get the best from your new Tricity Bendix cooker, we ask that you PLEASE READ THESE INSTRUCTIONS CAREFULLY. Particular attention should be made to cooking times and temperatures which may differ from your previous cooker.

It is most important that this instruction book is retained with the cooker for future reference. Should the cooker be sold, or if you move house and leave the cooker, always ensure that the book remains with the cooker. This will enable the new owner to be acquainted with the functioning of the cooker and the relevant warnings.

Please read the whole instruction book before attempting to use the cooker ensuring you follow the recommendations given.

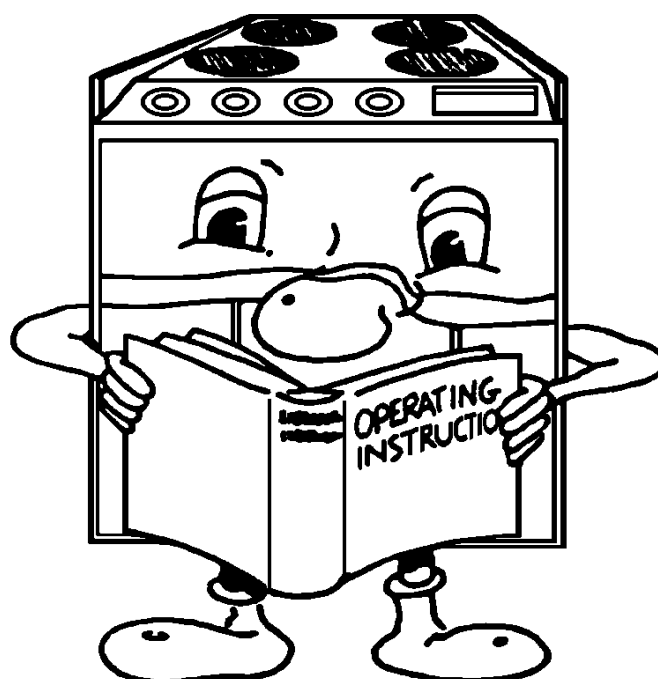

## SAFETY

THESE WARNINGS ARE PROVIDED IN THE INTERESTS OF YOUR SAFETY. ENSURE THAT YOU UNDERSTAND THEM ALL BEFORE INSTALLING OR USING THE COOKER.

PLEASE  
READ  
CAREFULLY



### BEFORE INSTALLATION



This cooker is heavy and care **must** be taken when moving it.



**Ensure** that all packaging, both inside and outside the cooker has been removed before the appliance is used.



**Do not** try to move the cooker by pulling the door handles.

The electrical installation work **must** be undertaken by a qualified electrician / competent person.



**It is dangerous** to alter or modify the specifications of the cooker in any way.

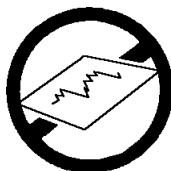

**Do not** use the cooker if the ceramic glass is damaged. If a fault or crack becomes visible during cooking, disconnect the cooker immediately from the electricity supply and contact the Customer Service Centre.

**Do not** place silver foil or plastic containers on ceramic glass.

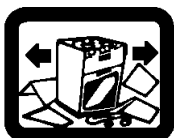

After installation, please dispose of the packaging with due regard to safety and the environment.

### DURING OPERATION



**Do not** use this cooker if it is in contact with water. **Never** operate it with wet hands.



This cooker is designed to be operated by adults. Young children **must not** be allowed to tamper with the cooker or play with the controls.

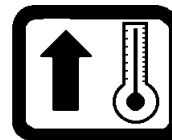

Accessible parts especially around the grill area may become hot when the cooker is in use. Children should be **kept away** until it has cooled.

Take **great care** when heating fats and oils as they will ignite if they become too hot.

This cooker has been designed for cooking edible foodstuffs only, and **must not** be used for any other purposes.



**Never** place plastic or any other material which may melt in the oven or on the hob.



**Ensure** cooking utensils are large enough to contain foods to prevent spillages and boil overs.

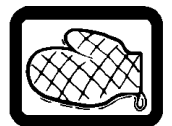

The handles of saucepans which are smaller than the heated area on the hob will become hot. **Ensure** your hand is protected before handling the pan.



Take care to follow the recommendations given for tending the food when grilling.

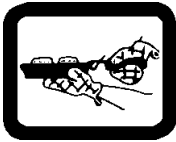

**Ensure** that you support the grill pan when it is in the withdrawn or partially withdrawn position.

**Ensure** that all vents are left unobstructed to ensure ventilation of the oven.

**Ensure** that the anti-tilt shelves are put in place correctly. Refer to instructions on pages 18 and 20.

**Never** line any part of the cooker with aluminium foil.



**Always** stand back from the cooker when opening the oven door to allow any build up of steam or heat to release.



**Do not** place sealed cans or aerosols inside the oven. They may explode if they are heated.

**Do not** leave the hotplates switched ON for long periods when not covered by a saucepan. The controls may overheat.

## AFTER USE



**Ensure** that all control knobs are in the OFF position when not in use.



For hygiene and safety reasons this cooker should be kept clean at all times. A build-up of fats or other foodstuffs could result in a fire, especially in the grill pan.



**Do not** leave utensils containing foodstuffs, e.g. fat or oil in or on the cooker in case it is inadvertently switched ON.

Cookers and hobs become very hot, and retain their heat for a long period of time after use. Children should be kept well away from the cooker until it has cooled.

## GENERAL



**Under no circumstances** should repairs be carried out by inexperienced persons as this may cause injury or serious malfunction. This cooker should be serviced by an authorised Service Engineer and only genuine approved spare parts should be used.



**Do not** stand on the cooker or on the open oven door.



**Do not** hang towels, dishcloths or clothes from the cooker or its handle. They are a safety hazard.



**Always** allow the cooling fan to cool the cooker down before switching off at the wall prior to carrying out any cleaning or maintenance work.



Only clean this cooker in accordance with the instructions given in this book. Extreme care must be taken when using a ceramic hob scraper.

Your safety is of paramount importance.

Therefore, if you are unsure about any of the meanings of these WARNINGS contact the:

Consumer Care Department  
Telephone (01635) 525542

## INTRODUCTION

### WARNING: THIS COOKER MUST BE EARTHED

#### RATING PLATE

Record the model, product and serial numbers on the back cover from the rating plate. This is situated on the lower front frame of the cooker and can be seen upon opening the fan oven door.

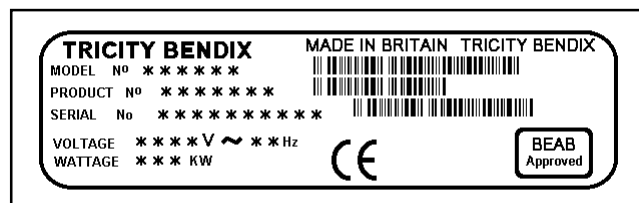

The cooker must be protected by a suitably rated fuse or circuit breaker. The rating of the cooker is given on the rating plate.

**Do not remove the rating plate from the cooker as this may invalidate the guarantee.**

#### INSTALLATION

If your cooker has been damaged in transit, contact your supplier immediately. **DO NOT** attempt to install it.

Your cooker left the factory fully packaged to protect it from damage. If it is delivered without packaging and damage has occurred the manufacturer cannot accept responsibility. Contact your supplier for advice.

Once the packaging has been removed the cooker should only be moved by hand. **DO NOT** use a sack barrow or any other aid to lift the cooker as damage may occur.

Connection to the electricity supply must be carried out by a qualified electrician/competent person.

The electrical connection should be made using a double pole isolating switch (cooker socket) with at least 3mm contact separation. The cable must have conductors of sufficiently high cross-sectional area to prevent overheating and deterioration.

The recommended cross-section area is six square millimetres (6.00mm<sup>2</sup>).

The cable should be routed away from potentially hot areas marked by X in the diagram below.

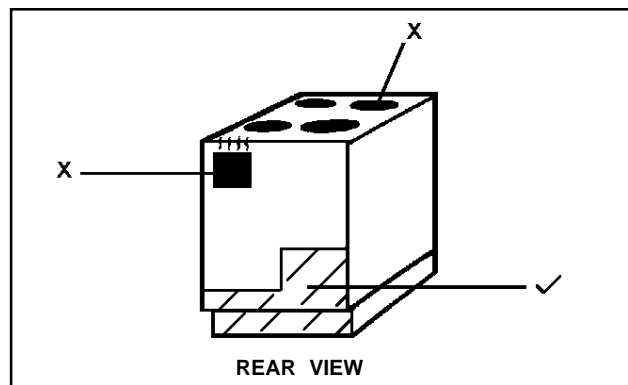

To move the cooker, open the fan oven door, and lift the cooker by holding inside the top of the compartment.

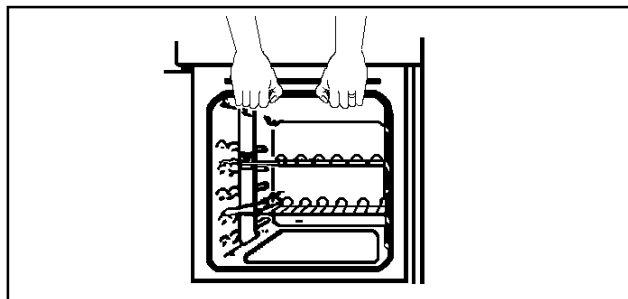

This is a type Y cooker which means it is free-standing and can be fitted with cabinets on one or both sides. It may also be fitted in a corner setting.

Ensure that the cooker is standing level.

Side walls which are above hob level should be protected by heat resistant non-combustible material and **MUST NOT** be nearer than 40mm to the hob side.

A nominal air gap of 2mm all around the cooker is required to enable the cooker to be moved into position.

A spacer has been incorporated into the back of the appliance to ensure an air gap of 10mm is maintained at hotplate level. Tiles or other forms of deep wall covering should not obscure this gap.

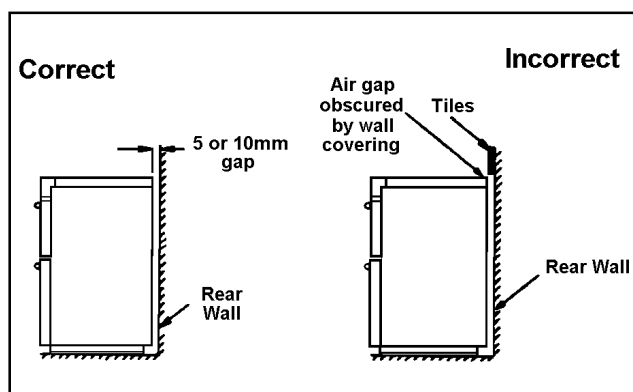



**Note:** Vapours from the oven vents may in time cause discoloration of wallcoverings behind the cooker. For ease of cleaning it may be preferable to tile behind the cooker.

Overhanging surfaces or a cooker hood should be a minimum of 685mm above the hob.

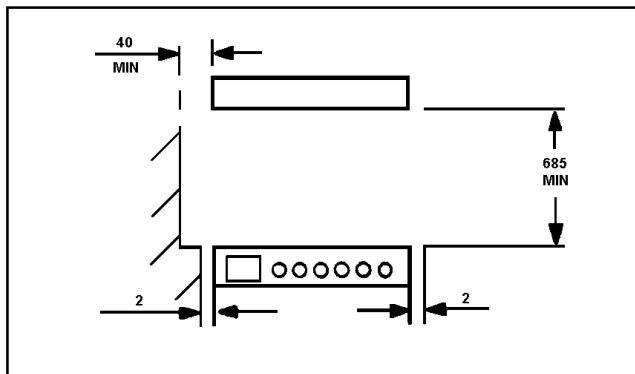

It is important to ensure that the cooker is level after installation. Levelling feet are fitted to the front of the cooker to accommodate uneven floors.

## GENERAL NOTES ON USING YOUR COOKER

We suggest that you run the oven elements for 10 - 15 minutes at 220°C to burn off any residue from their surfaces.

The procedure should be repeated with the grill for approximately 5 - 10 minutes.

During this period an odour may be emitted, it is therefore advisable to open a window for ventilation.

## ABOUT CONDENSATION AND STEAM

When food is heated it produces steam similar to a boiling kettle. The ovens are vented to allow some of this steam to escape. However, always stand back from the cooker when opening the oven door to allow any build up of steam or heat to release.

If the steam comes into contact with a cool surface on the outside of the cooker, e.g. a trim, it will condense and produce water droplets. This is quite normal and is not caused by a fault on the appliance.

To prevent discoloration, regularly wipe away condensation and also soilage from surfaces including the vent at the rear of the hob. See note at the top of this page.

For your safety wallcoverings at the rear of the cooker should be securely fixed to the wall.

## THE COOLING FAN FOR THE CONTROLS

The cooling fan operates immediately when the grill or top oven is switched on. It may run on after the controls are switched off until the appliance has cooled. If an automatic programme has been set the cooling fan does not switch on until the cooktime begins.

**Note:** The action of the cooling fan will depend on how long the top oven or grill have been used and at what temperature. It may not run on where the grill or top oven has been used for a short time or at low temperatures. Do not switch the cooker off at its power point until the cooling fan has cooled the cooker down.

## CONTROL PANEL INDICATOR NEONS

These lights indicate whether the ovens are switched on.

The neons also indicate when the set temperature has been reached. They will turn on and off during use to show that the temperature is being maintained.

If the neons do not operate as the instructions indicate the controls have been incorrectly set. Return all controls to zero and re-set following the instructions for the required setting.

When the oven has been set for automatic cooking the neon will remain unlit until the cooktime begins.

## COOKWARE

Baking trays, oven dishes etc., should not be placed directly against the grid covering the fan at the back of the oven.

Do not use baking trays larger than 30cm x 35cm (12" x 14") as they will restrict the circulation of heat and may affect performance.

## GRILL AND OVEN FURNITURE

The following items of grill and oven furniture have been supplied with the cooker.

1 grill pan

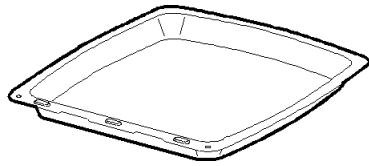

1 grill pan handle

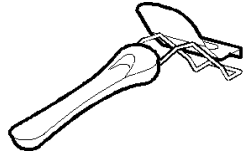

1 grill pan grid

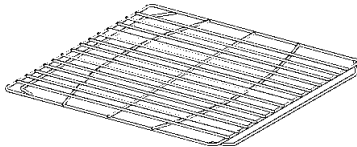

1 grill deflector

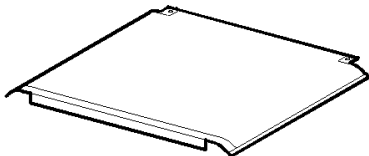

1 meat tin

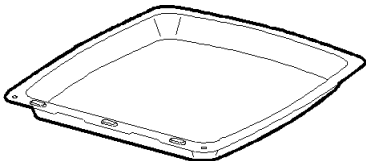

1 trivet

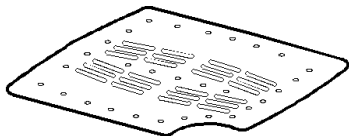

1 cranked shelf  
for grilling and top  
oven cooking only

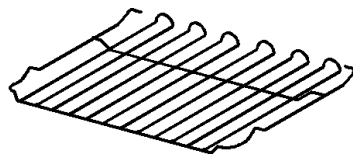

2 straight shelves  
for main oven cooking

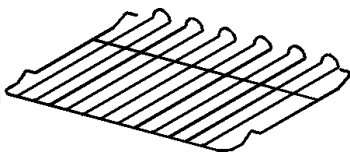

The grill deflector sits above the grill element and prevents fat splashing onto the grill roof. The deflector may be easily removed for cleaning.

Scuffing of the Stayclean main oven lining by the oven furniture pack may occur during transit. These marks will disappear after the oven elements have been burnt off for the first time.

# GETTING TO KNOW YOUR COOKER

## THE CONTROL PANEL

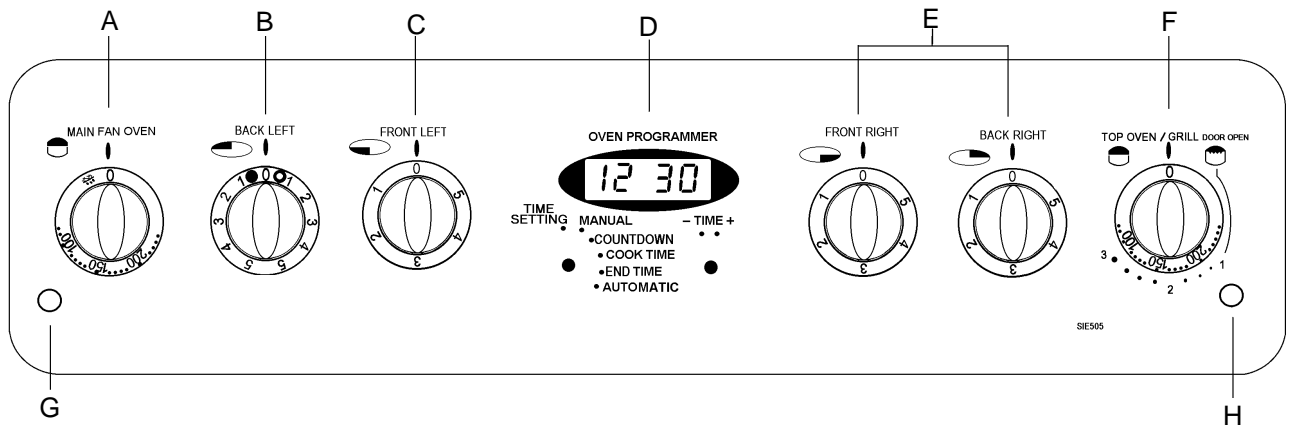

## FEATURES

- |   |   |                                 |
|---|---|---------------------------------|
| A | - | Main Fan Oven                   |
| B | - | Dual Hotplate Control           |
| C | - | Hotplate Control                |
| D | - | Timer                           |
| E | - | Hotplate controls               |
| F | - | Top Oven / Grill Control        |
| G | - | Main Fan Oven Indicator Neon    |
| H | - | Top Oven / Grill Indicator Neon |

## THE TIMER

Please note that this is a 24 hour clock, for example 2.00 pm is shown as 1400.

In the following pages we explain how to set the controls. Read through them a few times until you are familiar with the procedure. We have supplied a plastic card as a quick reference when setting the timer.

If the oven is switched off on the wall, or there is a loss of power, the clock will stop and you will not be able to use the ovens. When you first switch the electricity supply on, the timer display will flash.

### TO SET THE TIME OF DAY

Turn the selector knob to 'manual' then turn to 'Time setting'.

Set the correct time by turning and holding the setting knob clockwise. Adjust the time by turning the setting knob in either direction.

Turn the selector knob back to 'manual'.

### TO CHANGE THE AUDIBLE SIGNAL

When the right hand knob is turned anti-clockwise, a choice of three audible signals are available. To select the choice of signal required, rotate knob anti-clockwise and release. Repeat procedure to choose desired signal.

### TO USE THE MINUTE MINDER

Turn the selector knob to 'countdown'. Turn the setting knob clockwise until the display shows the time you want. The bell symbol (  ) will be showing and this will stay lit up during the time. Our diagram shows the timer set to 5 minutes.

If you change your mind and want to cancel the time you have set, simply turn the setting knob anticlockwise. Then turn the selector to 'manual'.

When you are using the minute minder you can make the clock show the time of day by turning the selector knob to 'manual'. The bell symbol will stay on to remind you that the minute minder is set. At the end of the timed period an alarm will sound and the bell symbol will go out.

Switch off the alarm by turning the selector knob to 'Time setting'. Then turn to 'manual' and the time of day will show in the display.

#### Note:

You can use the minute minder when an automatic sequence has been set, as long as you remember the following point.

- 1 Turn the selector knob to 'Automatic' as soon as you have entered the timed period into the display.

### AUTOMATIC CONTROL

You can use the automatic control for the main oven only.

When you use the automatic controls for the first time it's probably best to choose a time when you are at home. That way you can check to make sure you've set everything correctly and you'll feel much more confident when you are away from home in the future.

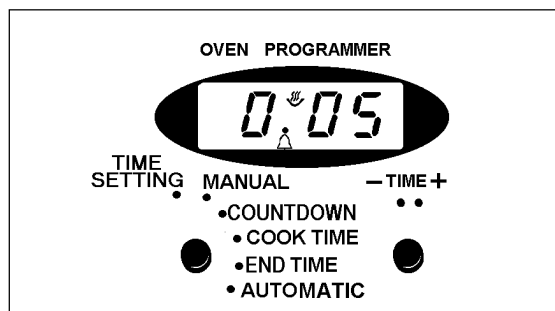
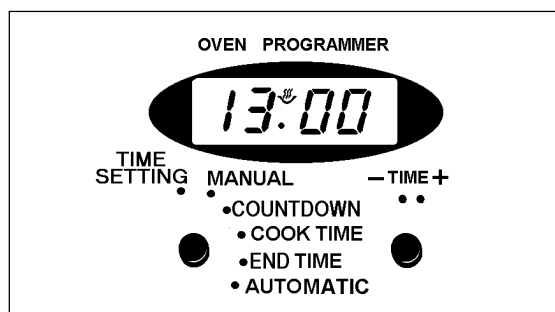
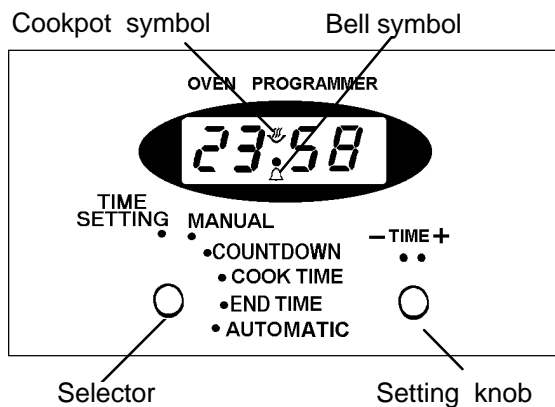

## SETTING THE CONTROLS FOR AUTOMATIC USE

This is very easy. All you have to do is work through the steps below. The clock will work out the rest for itself.

- |   |   |  |
|---|---|--|
| 1 | Is the electricity supply on?                   |  |
| 2 | Is the clock showing the correct time?          | To adjust turn the selector knob to 'manual' then turn to 'Time setting'. Turn the setting knob in either direction.   |
| 3 | How long will the food take to cook?            | Turn the selector knob to 'cooktime'. Then turn the setting knob until the length of time you want the food to cook shows in the display. The maximum cooking time is 10 hours. 'Auto' will show in the display.   |
| 4 | What time do you want the food to be cooked by? | Turn the selector knob to 'End time'. Turn the setting knob until the time the oven is to switch off shows in the display. The cookpot (  ) will go out. The 'End time' must not be more than 23 hours 59 minutes from the time of day. For example if the time of day is 9.00 am the latest 'End time' will be 8.59 am the next day. |
| 5 | Set to automatic.                               | Turn the selector knob to 'Auto'.  |
| 6 | Turn on the oven control.                       | Turn the oven control to the correct temperature setting.  |

The time shown on the right gives an example of setting the automatic controls when the time is 9.00 am, the food is to be cooked for 2½ hours and the food is needed at 6.00 pm (1800 hours).

The clock will work out what time the oven will switch itself on and it will turn the oven off at the end. Once the automatic sequence is finished there will be an alarm to remind you that you need to set the oven for manual operation. To do this turn the selector knob to 'manual'. Turn off the oven control.

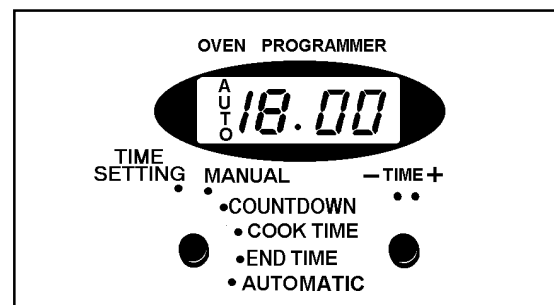
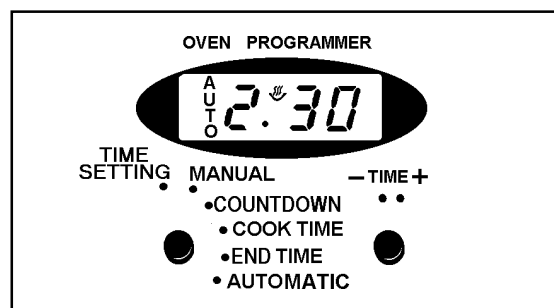
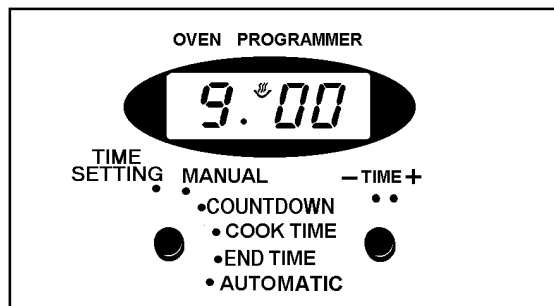

# THE CERAMIC HOB

**CAUTION: DO NOT USE THE COOKER IF THE CERAMIC GLASS IS DAMAGED. IF A FAULT OR CRACK BECOMES VISIBLE DURING COOKING, DISCONNECT THE COOKER IMMEDIATELY FROM THE ELECTRICITY SUPPLY AND CONTACT THE CUSTOMER SERVICE CENTRE.**

## USING THE HOB

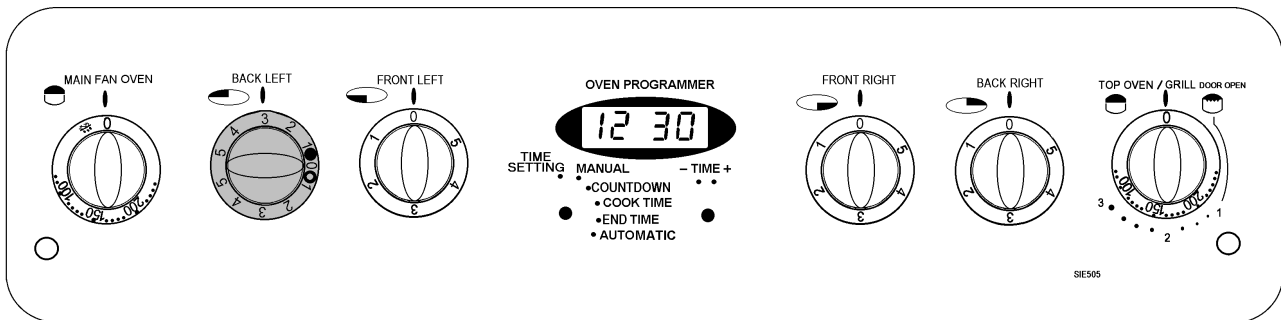

- To operate the dual hotplate turn the control knob clockwise for the full area, or anticlockwise for the centre section.
- The inner section is very economical when cooking with small diameter saucepans.
- For single hotplates, turn the control knob in either direction to vary the heat setting. The highest number represents the hottest setting and the lowest the coolest setting. Choose a setting appropriate to the quantity and type of food to be cooked.
- This model has the added feature of Rapid Power Zone hotplates which react more quickly than the other ceramic hotplates and are easily identified by their instant red glow.

## RECOMMENDED SAUCEPANS

For speed and economy only good quality saucepans with flat bases and close fitting lids are recommended. The saucepan base should be approximately the same size as the cooking area, a base diameter of up to 225mm (9") may be used on a 180mm (7") heated area.

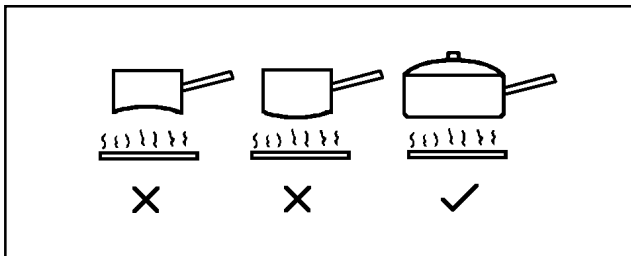

Ensure that new saucepans are well scrubbed to remove edges and take off any deposits left from manufacture.

**Pressure cookers, preserving pans** etc., should comply with the recommendations given above.

Traditional round bottomed Woks must not be used even with a stand. Woks with flat-bottomed bases are available and do comply with the above recommendations.

## NOTE

Occasionally the heated areas may be seen to switch ON and OFF when higher heat settings are being used. This is due to a safety device which prevents the glass from overheating. Some switching ON and OFF when cooking at high temperatures, e.g. deep fat frying is quite normal, causes no damage to the hob and little delay in cooking times.

Excessive switching may however be caused by the use of an unsuitable saucepan or a saucepan which is smaller than the heated area. If excessive switching occurs, discontinue use of the saucepan.

## HINTS AND TIPS

- Lift, rather than slide saucepans on and off the heated areas. This will reduce the risk of scratches and metal marks from saucepans with aluminium bases. Metal marks can be easily cleaned off providing they are not allowed to burn on.

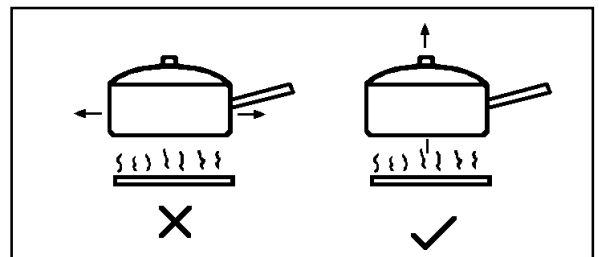

- Follow any guidelines provided by the saucepan manufacturer, particularly those relating to recommended heat settings.
- Avoid using thin badly dented or distorted saucepans. Those with uneven bases should not be used.

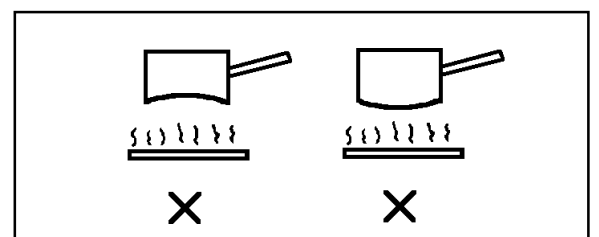

- To prolong the life of hotplates:-
  - Never use utensils with a skirt, e.g. a bucket.
  - Never use an asbestos mat.
  - Never leave the hotplates ON when not covered with a saucepan.
- Ensure that hob and saucepans are clean and dry before the start of cooking to reduce cleaning.
- Follow the cleaning instructions very closely to keep the hob looking like new.
- **If spillage occurs with sugar solutions, e.g. jams and syrups, it must be wiped from the hob before it sets and becomes hard otherwise damage to the hob will occur.**

## HOT HOB INDICATOR

The ceramic hob is fitted with a hot hob indicator light which illuminates when the hob is too hot to touch. The light will go OFF when the hob has cooled.

## DEEP FAT FRYING

### SPECIAL FRYING NOTE:

For safety purposes when deep fat frying, fill the pan one-third full of oil, DO NOT cover the pan with a lid and DO NOT leave the pan unattended. In the unfortunate event of a fire, switch the cooker OFF at the electricity supply and cover the pan with a lid or damp cloth to assist in smothering the flames.

DO NOT use water on the fire. Leave the pan to cool for at least 30 minutes before moving it.

DO NOT leave the fat or oil in the frying pan on the hob to store it in case the hob is inadvertently switched ON.

#### 1. Preparing the food

Seal the food by coating with flour, egg and breadcrumbs or batter. **Do not** use a basket with batter coated foods as they will stick.

#### 2. Amount of oil

For safety purposes fill the pan only one-third full of oil.

#### 3. Testing the temperature of the oil

It is advisable to use a thermometer to test the temperature of the oil. Alternatively, drop a small cube of bread into the oil which should brown in just under a minute if the oil is at the correct temperature of 190°C/375°F.

#### 4. Cooking the food

Lower the food gently into the oil. **Do not** add too much food at once or the temperature of the oil will be reduced and may result in soggy, greasy food.

Turn the food if necessary; doughnuts float to the surface so will not brown on the upperside if not turned. Once cooked, drain the food on absorbent paper.

#### 5. Double frying chips

Double frying will ensure good chips. First fry the chips for a few minutes at 170°C/340°F to seal the outside. Remove the chips from the oil. Increase the temperature of the oil to 190°C/375°F to finish cooking and brown the chips.

Chips may be kept for several hours after the first frying before finishing off with the second frying.

#### 6. Frying temperatures

	Celsius Scale (°C)	Fahrenheit Scale (°F)
	150	300
First frying of potatoes	<b>170</b>	<b>340</b>
	175	350
	180	360
Second frying of potatoes	<b>190</b>	<b>375</b>
Frying chicken and fish	195	380
	200	390

## PRESERVING

1. DO NOT use a pan that overlaps the perimeter of the hob trim.
2. To allow for a full rolling boil, the pan should be no more than one third full when all the ingredients have been added. It is better to use two pans rather than overfill one, or use half quantities.
3. Use firm fruit or vegetables and wash well before using.
4. Preserving sugar gives clear jam, however granulated sugar is cheaper and gives equally good flavour.
5. Crystallization may be caused if sugar is not completely dissolved before bringing jam to the boil. Over boiling will affect the flavour, setting properties and colour of the jam.
6. To test jam for setting:

If a jam thermometer is available, boil jam to 104°C. Marmalade should be boiled to 106°C.

If a thermometer is not available, remove pan from heat, place sample of jam on a cold dish and cool quickly (i.e. in a freezer or frozen food storage compartment of a refrigerator). When cold, it will crinkle and hold the mark of a finger run through it, if it is at setting point.

7. The scum should be removed as soon as possible from the surface of the preserve after setting point has been reached. Marmalade should be allowed to cool before potting to prevent the peel rising.

## THE GRILL

**CAUTION - ACCESSIBLE PARTS MAY BECOME HOT WHEN THE GRILL IS IN USE. CHILDREN SHOULD BE KEPT AWAY.**

### SELECTING THE GRILL

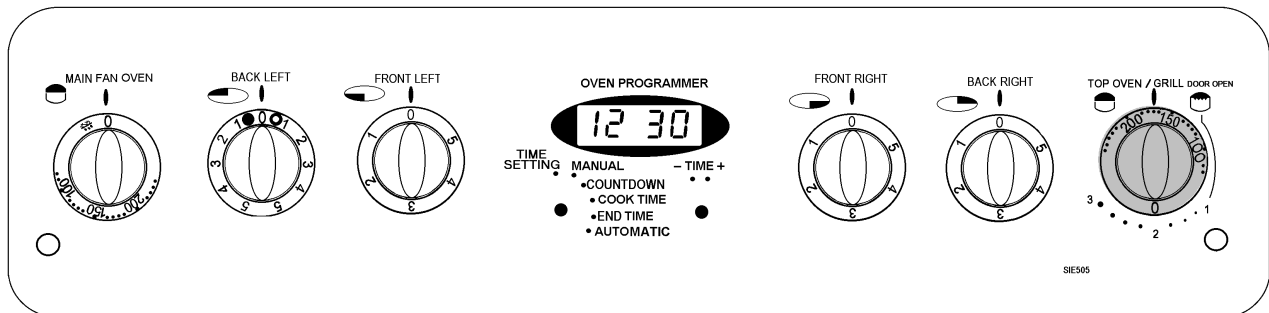

- To operate the grill open the grill door and turn the top oven/grill control clockwise so that '0' on the control knob lines up with setting 1, 2 or 3.
- Setting 3 represents the grill on full. At settings 1 and 2 the grill may turn on and off over time and you may prefer to use these settings for keeping food warm.

### THINGS TO NOTE

THE GRILL DOOR MUST BE LEFT FULLY OPEN DURING GRILLING. IF THE DOOR IS CLOSED THE TOP OVEN WILL OPERATE.

If the grill door is accidentally closed during grilling, the grill will cut out and the top oven will operate.

The cranked shelf **MUST** only be used in the grill compartment, but a straight shelf from the main oven may be used to provide alternative positions.

Some smoke from fat splashes may be evident as the grill element cleans itself.

The top oven **cannot** be operated when the grill is in use.

Only the inner element will operate when grilling.

### THE GRILL PAN AND HANDLE

The grill pan is supplied with a removable handle.

To attach the handle, place the wirework under the cut out in the pan so that the metal plate hooks over the top of the grill pan.

Slide the handle to the left and over the central bump on the grill pan.

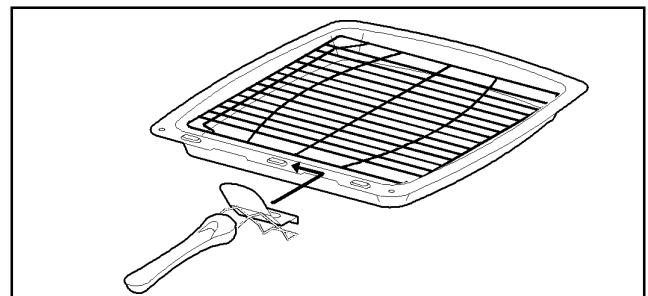

Ensure the handle is correctly located. It is not necessary to remove the grill pan handle during grilling.

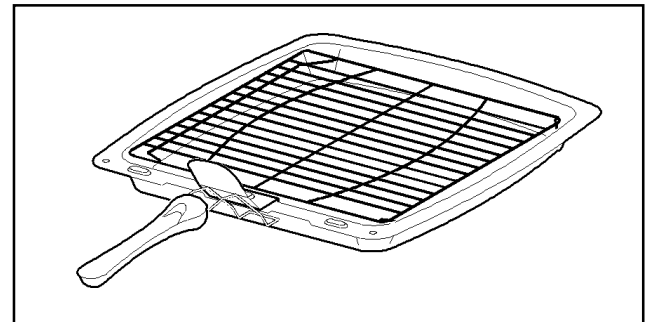

To remove the handle, slide the handle to the right and lift the handle away from the cut out on the grill pan.

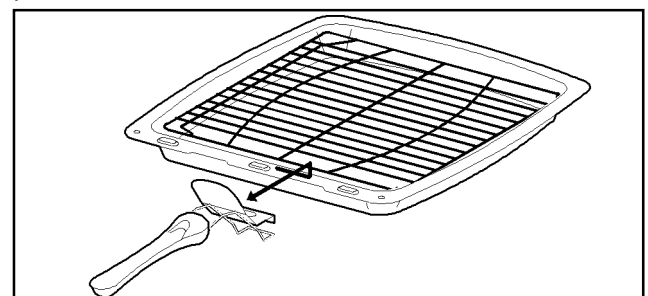

Place the grill pan on the shelf so that the pan is positioned centrally beneath the grill.



To check the progress of the food being grilled, the grill pan should be withdrawn on the shelf to attend to food during cooking or the carrier shelf can be lifted away from the cooker and rested on a heat resistant work surface.

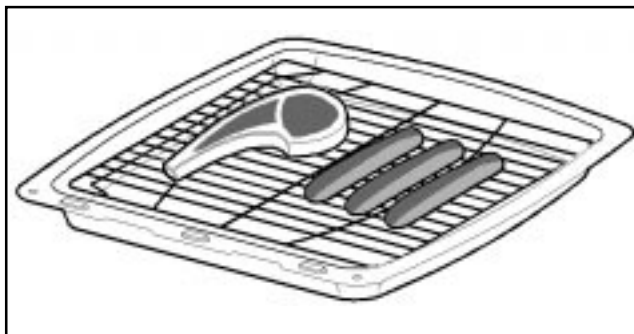

### HINTS AND TIPS

- Food should be thoroughly dried before grilling to minimise splashing. Brush lean meats and fish lightly with a little oil or melted butter to keep them moist during cooking.
- Adjust the height of the grilling grid and grill pan runner position to allow for different foods.
- Accompaniments such as tomatoes and mushrooms may be placed underneath the grid when grilling meats.

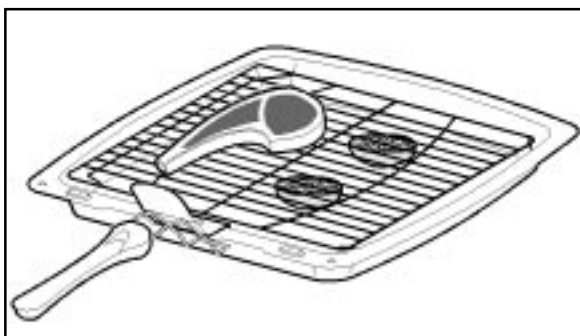

- When toasting bread use the cranked shelf in position 2 with the grid in the high position.
- Preheat the grill on a full setting for a few minutes before sealing steaks or toasting. Adjust the heat setting and the shelf as necessary during cooking.
- The food should be turned over during cooking as required.

### NOTE

If you require an additional handle for your grill pan, this can be ordered from your local Tricity Bendix Service Centre by quoting part number 311479800\6.

## GRILLING CHART

FOOD	SHELF	GRILL TIME (mins in total)
Bacon Rashers	Adjust	5-6
Beefburgers	shelf	10-15
Chicken Joints	position	30-40
Chops - Lamb Pork	and grill	15-20 20-30
Fish - Whole	pan	15-25
Trout/Mackerel	grid	10-15
Filletts - Plaice/Cod	to	20-30
Kebabs	suit	8-12
Kidneys - Lamb/Pig	different	10-20
Liver - Lamb/Pig	thicknesses	20-30
Sausages	of	6-12
Steaks - Rare Medium Well Done	food	12-16 14-20
Toasted Sandwiches		3-4

The times quoted above are given as a guide and should be adjusted to suit personal taste.

## THE TOP OVEN

### USES OF THE TOP OVEN

The top oven is the smaller of the two ovens. It is heated by elements in the top and bottom of the oven. It is designed for cooking on one level and for small quantities of food. It gives especially good results if used to cook fruit cakes, sweet or savoury flans or quiche.

The top oven is also ideal for use as a warming compartment to warm dishes and keep food hot. Use a temperature setting of 80° - 100°C on the top oven control dial.

### SELECTING THE TOP OVEN

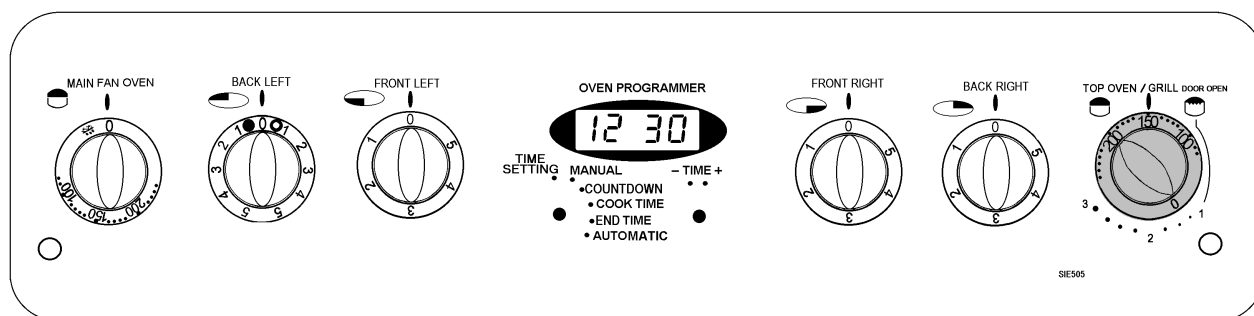

- Turn the top oven temperature control to the required setting. Close the door.

#### THINGS TO NOTE

1. The grill cannot be operated when the top oven is in use. Only the outer part of the top oven element in conjunction with the base element will operate when using the top oven.
2. The top oven indicator neon will glow until the oven has reached the desired temperature and then go out. It will turn ON and OFF showing that the oven temperature is being maintained.
3. Always place plates on the oven shelf to warm. Never place directly on the top oven base as it becomes very hot and damage may occur.

#### TO FIT THE TOP OVEN SHELF

The cranked shelf **MUST** only be used in the top oven compartment, but a straight shelf from the main oven may be used to provide alternative positions.

The shelf should be fitted with the straight rods uppermost on the frame and the forms towards the back of the oven. If not fitted correctly the anti-tilt and safety stop mechanism will be affected.

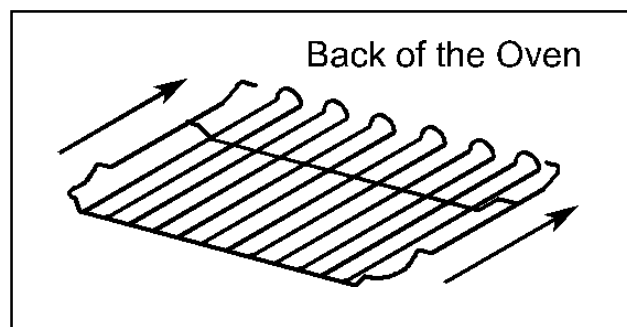

## HINTS AND TIPS

- Most cooking should be carried out using an oven shelf positioned in one of the shelf runners.

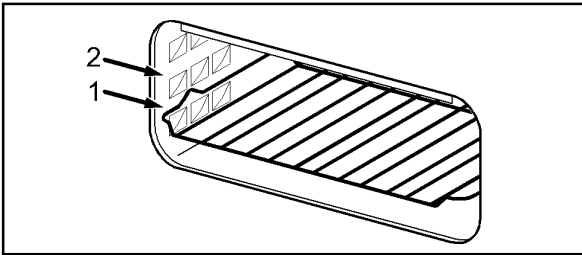

- Larger roasts and casseroles should normally be cooked in the main oven. However, they may be cooked on a flat shelf placed on the base of the top oven provided there is sufficient room for air circulation around the food.
- Stand dishes on a suitably sized baking tray on the shelf to prevent spillage onto the oven base and to help reduce cleaning.



- There should always be at least 2.5cm (1") between the top of the food and the element. This gives best cooking results and allows room for rise in yeast mixtures, Yorkshire puddings etc.
- When cooking cakes, pastry, scones, bread etc., place the tins or baking trays centrally on the shelf directly below the element.

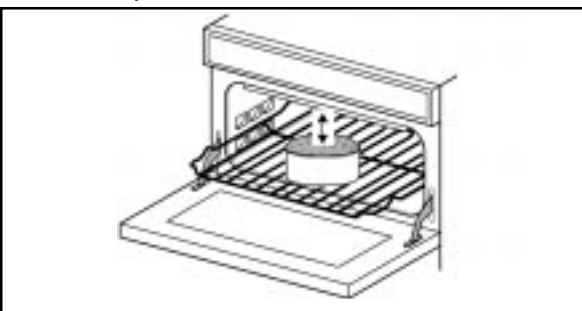

- DO NOT place dishes or baking trays directly onto the oven base as it becomes very hot and damage may occur.

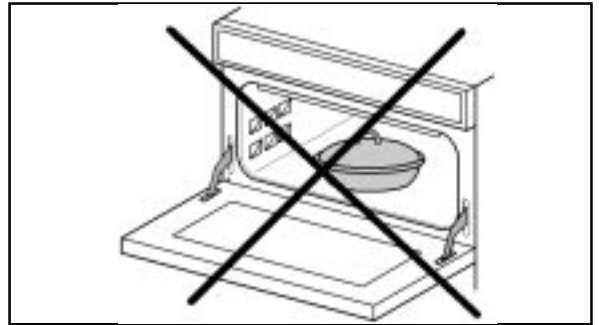

- The material and finish of the baking trays and dishes will affect the degree of base browning of the food. Enamelware, dark, heavy or non-stick utensils increase base browning. Shiny aluminium or polished steel trays reflect the heat away and give less base browning.
- DO NOT use the grill pan or meat tin as a baking tray as this will increase base browning of the food.
- Because of the smaller cooking space, lower temperatures and shorter cooking times are sometimes required. Be guided by the recommendations on page 22.
- For economy leave the door open for the shortest possible time, particularly when placing food into a pre-heated oven.

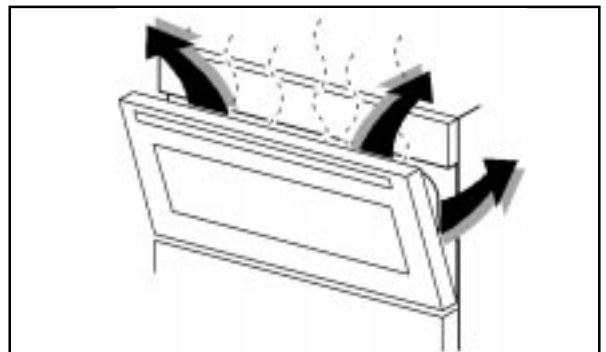

# THE MAIN FAN OVEN

## USES OF THE FAN OVEN

The oven is heated by an element around the fan situated behind the back panel. The fan draws air from the oven and the element heats the air which circulates in the oven via the vents in the back panel. The advantages of fan oven cooking are:

### PREHEATING

The fan oven quickly reaches its temperature, so it is not usually necessary to preheat the oven. Without preheating however, you may find you need to add an extra 5 - 10 minutes on the recommended cooking times. For recipes needing high temperatures, e.g. bread, pastries, scones, soufflés etc., best results are achieved if the oven is preheated first.

### COOKING TEMPERATURES

Fan oven cooking generally requires lower temperatures than conventional cooking. Follow the temperatures recommended in the chart on page 22. As a guide reduce temperatures by about 20° - 25°C for your own recipes using a conventional oven.

### BATCH BAKING

The fan oven cooks evenly on all shelf levels, especially useful when batch baking.

## SELECTING THE FAN OVEN

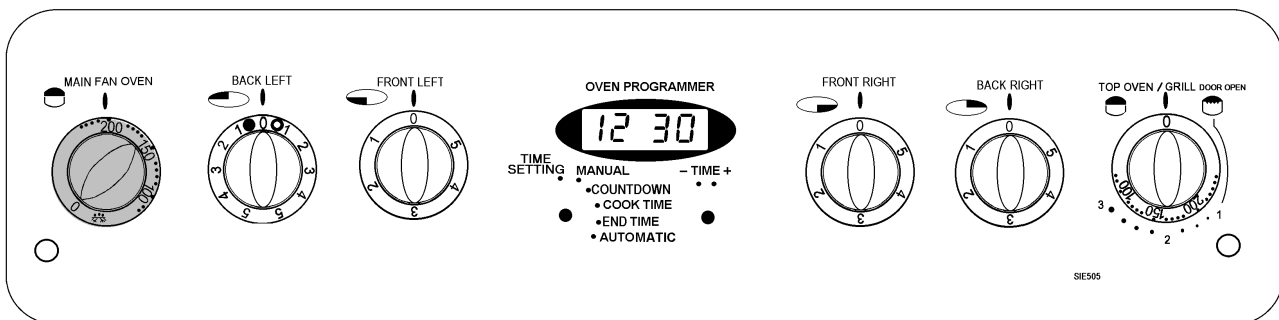

- Turn the main oven temperature control to the required setting.

### THINGS TO NOTE

1. The main oven indicator neon will glow until the oven has reached the desired temperature and then go out. It will turn ON and OFF periodically during cooking showing that the temperature is being maintained.
2. The interior oven light will come ON when the main oven control is turned.

## TO FIT THE MAIN OVEN SHELVES

The shelves should be fitted with the straight rods uppermost on the frame and the forms towards the back of the oven. If not fitted correctly the anti-tilt and safety stop mechanism will be affected.

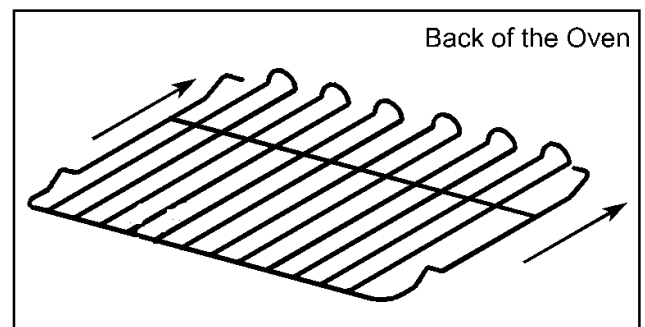

## HINTS AND TIPS

- Arrange the shelves in the required positions before switching the oven ON. Shelves are numbered from the bottom upwards.

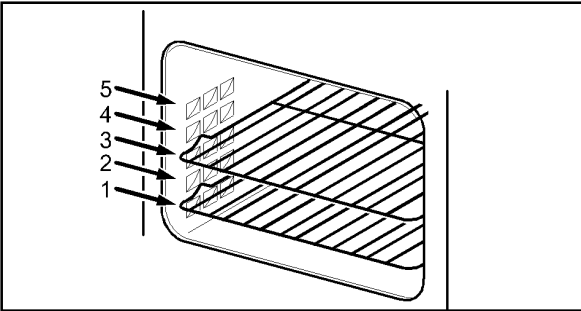

- When cooking more than one dish in the fan oven, place dishes centrally on different shelves rather than cluster several dishes on one shelf, this will allow the heat to circulate freely for the best cooking results.

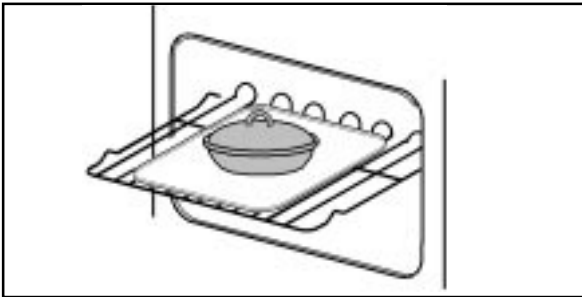

- When batch baking one type of food, e.g. Victoria sandwich cakes, those of similar size will be cooked in the same time.

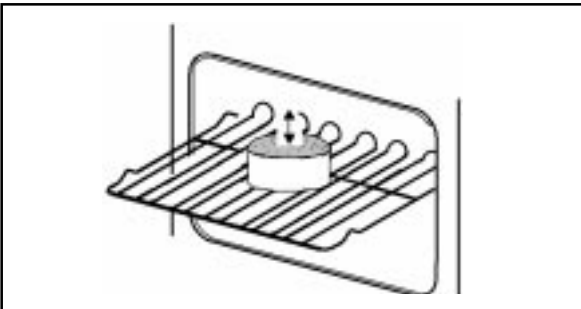

- It is recommended that when baking larger quantities, the shelf positions should be evenly spaced to suit the load being cooked. A slight increase in cooking time may be necessary.

- DO NOT place dishes or baking trays directly on the oven base as it interferes with the oven air circulation and can lead to base burning: use the lower shelf position. However, non critical dishes may be cooked on the oven base when more space is required.



- The use of excessively high temperatures can cause uneven browning. It may be necessary to reduce temperatures slightly. Refer to the recommendations given in the oven cooking chart see page 22.

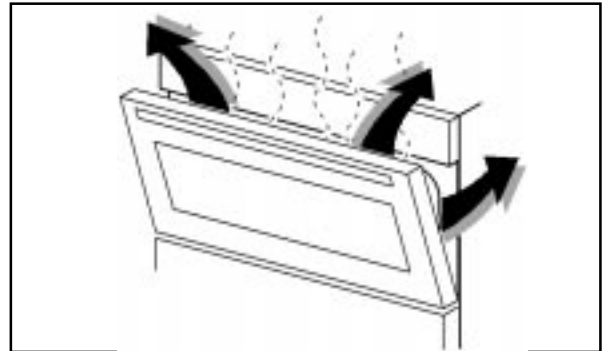

## OVEN COOKING CHART

The oven temperatures are intended as a guide only. It may be necessary to increase or decrease the temperature by 10° C to suit individual preferences and requirements.

FOOD	FAN OVEN		TOP OVEN			
	SHELF POSITION	COOKING TEMP °C	SHELF POSITION	COOKING TEMP °C	APPROX COOK TIME (m)	
Biscuits		180-190	1 crk.	170-190	10 - 20	
Bread		200-220	1 crk.*	200-220	25 - 30	
Bread rolls/buns	Shelf	200-220	1 crk.	200-220	15 - 20	
Cakes:	Small & Queen	160-170	1 crk.	180-190	18 - 25	
	Sponges	160-170	1 crk.	160-170	18 - 20	
	Victoria Sandwich	160-170	1 crk.	160-170	18 - 25	
	Madeira	140-150	1 crk.	140-150	1¼ - 1½h	
	Rich Fruit	130-140	1 crk.	130-140	2¼ - 2½h	
	Christmas	are not	130-140	1 crk.	130-140	3 - 4½h
	Gingerbread		140-150	1 crk.	140-150	depends on size
	Meringues	critical	80-100	1 crk.	90-100	1¼ - 1½h
	Flapjack		170-180	1 crk.	170-180	2½ - 3h
	Shortbread		130-140	1 crk.	140-150	25 - 30
Casseroles:	Beef/lamb	140-160	1 crk.*	140-160	45 - 65	
	Chicken	180-190	1 crk.*	180-190	2½ - 3h	
Convenience Foods		Follow manufacturer's instructions			1¼ - 1½h	
Fish	that oven	170-190	1 crk.	170-190	1¼ - 1½h	
Fish Pie (Potato Topped)		190-200	1 crk.*	190-200	20 - 30	
Fruit Pies, Crumbles		190-200	1 crk.	190-200	20 - 25	
Milk Puddings	shelves are	130-140	1 crk.	140-150	40 - 50	
Pasta, Lasagne etc.		190-200	1 crk.	170-180	1½ - 2h	
Pastry:	Choux	190-200	1 crk.	180-190	40 - 45	
	Eclairs, Profiteroles	170-180	1 crk.	170-180	30 - 35	
	Flaky/Puff Pies	210-220	1 crk.*	210-220	20 - 30	
Shortcrust	Mince Pies	190-200	1 crk.	190-200	25 - 40	
	Meat Pies	190-210	1 crk.*	190-210	15 - 20	
	Quiche, Tarts, Flans	180-210	1 crk.	180-200	25 - 35	
Patés and Terrines		150-160	1 crk.	150-160	25 - 45	
Roasting Meat, Poultry	when more	160-180	1 crk.*	160-180	1-1½h	
Scones		210-220	1 crk.	220-230	see roasting chart	
Shepherd's Pie		190-200	1 crk.*	190-200	8 - 10	
Soufflés	than one is	170-180	1 crk.	170-180	30 - 40	
Vegetables:	Baked Jacket Potatoes	180-190	1 crk.	180-190	20 - 30	
	Roast Potatoes	180-190	1 crk.	180-190	1-1½h	
	Stuffed Marrow	180-190	1 crk.	180-190	1-1½h	
	Stuffed Tomatoes	used	180-190	1 crk.	180-190	30 - 35
Yorkshire Puddings:	Large	210-220	1 crk.	200-210	15 - 20	
	Individual	200-210	1 crk.	200-210	25 - 40	

Crk = Cranked Shelf

\* or a flat shelf on the oven base

**Note:** Shelf positions are counted from the bottom of the oven.

**Do not** use the cranked shelf from the grill in the fan oven.

## ROASTING CHART

ROASTING CHART		
INTERNAL TEMPERATURES - Rare : 50-60°C; Medium : 60-70°C; Well :70-80°C		
MEAT	SECOND/FAN OVEN	COOKING TIME
Beef	160-180°C	20-35 min per ½kg/1lb and 20-35 min over
Beef, boned	160-180°C	20-35 min per ½kg/1lb and 25-35 min over
Mutton and Lamb	160-180°C	25-35 min per ½kg/1lb and 25-35 min over
Pork and Veal	160-180°C	30-40 min per ½kg/1lb and 30-40 min over
Ham	160-180°C	30-40 min per ½kg/1lb and 30-40 min over
Chicken	160-180°C	15-20 min per ½kg/1lb and 20 min over
Turkey and Goose	160-180°C	15-20 min per ½kg/1lb up to 3½kg/7lb then 10 min per ½kg/1lb
Duck	160-180°C	25-35 min per ½kg/1lb and 25-30 min over
Pheasant	160-180°C	35-40 min per ½kg/1lb and 35-40 min over
Rabbit	160-180°C	20 min per ½kg/1lb and 20 min over
Potatoes with meat	160-180°C	according to size
Potatoes without meat	180-190°C	according to size

The roasting temperatures and times given in the chart should be adequate for most joints, but slight adjustments may be required to allow for personal requirements and the shape and texture of the meat. However, lower temperatures and longer cooking times are recommended for less tender cuts or larger joints.

Wrap joints in foil if preferred, for extra browning uncover for the last 30 - 60 min. cooking time.

# DEFROSTING

## USES OF DEFROST FEATURE

This main oven function defrosts most foods faster than more conventional methods. It is particularly suitable for delicate frozen foods which are to be served cold e.g. cream filled gateaux, cakes covered with icings or frostings, cheesecakes, biscuits, scones etc.

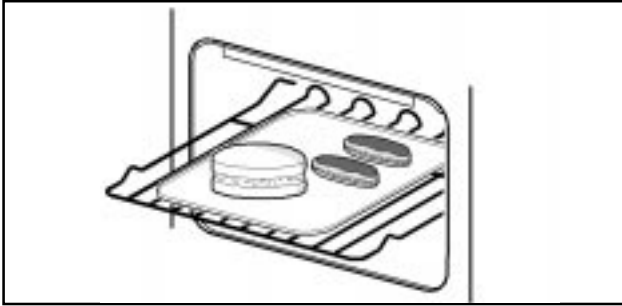

It is preferable to thaw fish, meat and poultry slowly in the fridge. However, this process can be accelerated by using the defrost function.

Small or thin fish fillets, frozen peeled prawns, cubed or minced meat, liver, thin chops, steaks etc., can be thawed in 1 - 2 hours.

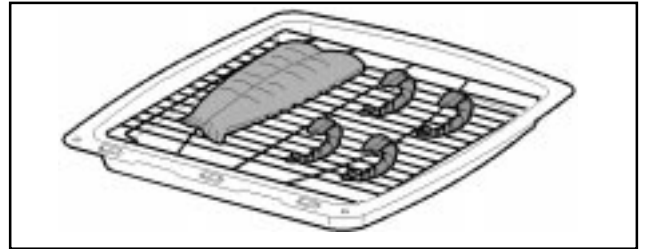

A 1kg/2¼lb oven ready chicken will be thawed in approximately 5 hours. Remove the giblets as soon as possible during the thawing process.

Joints of meat up to 2kg/4½lb in weight can be thawed using the defrost function.

**ALL JOINTS OF MEAT AND POULTRY MUST BE THAWED THOROUGHLY BEFORE COOKING.**

**ALWAYS COOK THOROUGHLY IMMEDIATELY AFTER THAWING.**

## SELECTING DEFROST

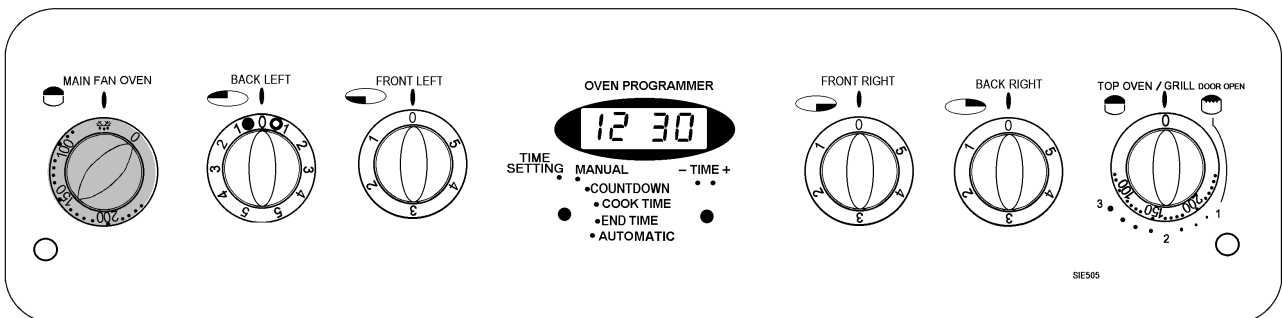

- Turn the main oven temperature control to the defrost setting.
- When defrost is selected, the oven indicator neon may come ON. It will stay on until the oven reaches room temperature and then go OFF. It may turn ON and OFF periodically during defrosting to maintain steady room temperature.

## THINGS TO NOTE

Care must always be taken when handling foods in the home. Always follow the basic rules of food hygiene to prevent bacterial and microbial growth and cross contamination when defrosting, cooking, cooling and freezing foods.

## HINTS AND TIPS

- Place the frozen food in a single layer where possible and turn it over half way through the defrosting process.

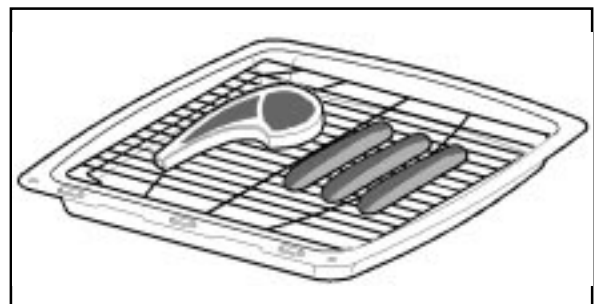

- The actual speed of defrosting is influenced by room temperature. On warm days defrosting will be faster than on cooler days.
- **DO NOT** leave food at room temperature once it is defrosted. Cook raw food immediately or store cooked food in the fridge.



## CARE AND CLEANING

**BEFORE CLEANING THE COOKER, ALWAYS ALLOW THE COOLING FAN TO COOL THE COOKER DOWN BEFORE SWITCHING OFF THE ELECTRICITY SUPPLY.**

### CLEANING MATERIALS

Before using any cleaning materials on your cooker, check that they are suitable and that their use is recommended by the manufacturer.

Cleaners that contain bleach should NOT be used as they may dull the surface finishes. Harsh abrasives should also be avoided. Multi-surface anti-bacterial cleaning products should not be used on the ceramic hob or on the surrounding trims.

### CLEANING THE CERAMIC HOB

Make sure the ceramic glass is cool before cleaning. It is important to clean the ceramic hob daily to prevent soilage being burnt on.

Take care to avoid the hob trims when cleaning the ceramic glass as they may be damaged by the cleaning agents recommended.

### DAILY CLEANING

Use the recommended Hob Brite Cleaner daily. If soilage is not allowed to burn on it will be much easier to clean off.

1. Apply a small amount of Hob Brite in the centre of each area to be cleaned.

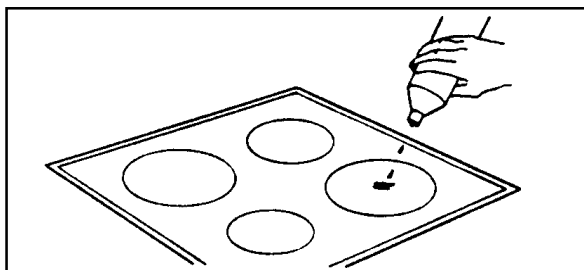

2. Dampen a clean paper towel or a plastic pad made specially for non-stick saucepans and rub vigorously until all marks are removed. This may take a few minutes.
3. Wipe off residues of cleaner with another damp paper towel and polish dry with a soft cloth.

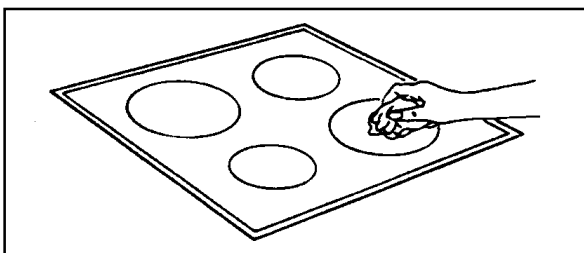

If Hob Brite is unavailable, one or more of the cleaning agents below may be used temporarily:

- a) Jif Cream Cleaner
- b) Baking Soda

### TO REMOVE MORE STUBBORN MARKS

1. Bar-Keepers Friend may be used to clean off more stubborn stains or to remove discolourations. It may be necessary to rub the marks hard for several minutes.
2. Use a plastic pad specially for non-stick saucepans with Bar-Keepers Friend for removal of more stubborn soilage.

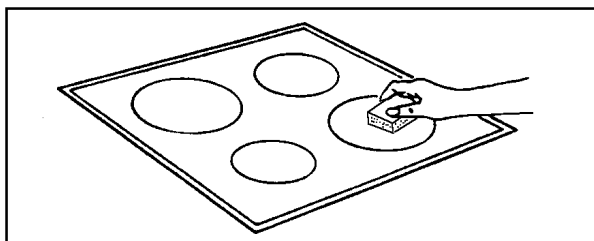

### TO REMOVE BURNT ON SOILAGE

We strongly recommend the use of a ceramic hob scraper (incorporating a single edge razor blade) to remove spillage on the hob, in particular sugar solutions, which if not removed can cause permanent damage.

1. Make sure the ceramic glass is cool.
2. Use a ceramic hob scraper with care at an angle of 30° to remove as much soilage as possible.
3. Use Bar-Keepers Friend or Hob Brite to finish off as directed above.

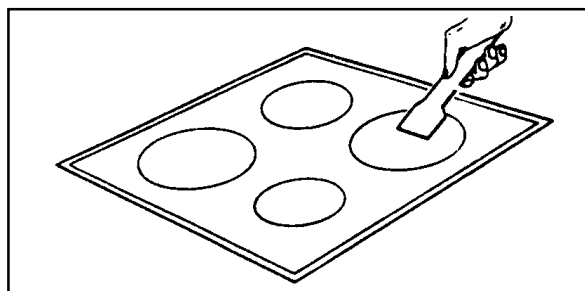

### TO REMOVE DISCOLOURATIONS OR WHITE AND SILVER MARKS

These marks sometimes give the impression of being in or underneath the hob glass. They can almost always be removed provided they have not become excessively burnt on. Follow the instructions under 'To Remove more Stubborn Marks' above.

If this is unsuccessful, make up a paste of one part water to three parts Cream of Tartar and leave on the discoloured areas overnight. The marks should be easily removable the next day provided they have not been excessively burnt on. The paste should be thoroughly washed off afterwards.

## HINTS AND TIPS

### TO REDUCE HOB SOILAGE:

- Make sure the bottom of the saucepan and the cooking area are clean and dry before cooking begins.
- Ensure saucepans are large enough to accommodate food to avoid boil overs.
- If possible, wipe up spills and splatters as they occur, but take care to avoid steam burns.
- Avoid using a dishcloth or sponge to clean the hob. These may leave a layer of soiled detergent on the hob surface which will burn and discolour the next time the hob is used.
- Avoid the use of:
  - Household detergents and bleaches.
  - Impregnated plastic or nylon pads that are not described as suitable for non-stick saucepans.
  - Brillo pads, Ajax pads, steel wool pads.
  - Chemical oven cleaners, e.g. aerosols and oven pads.
  - Rust stain, bath and sink stain removers.
- **Any of the above products may cause damage to the hob.**
- It is dangerous to mix different cleaning products. The chemicals in them may react with each other with hazardous results.
- **SOILAGE FROM SUGAR SOLUTIONS MUST BE REMOVED FROM THE HOB BEFORE THE SYRUP HAS SET OTHERWISE DAMAGE TO THE HOB SURFACE WILL OCCUR.**
- Avoid placing plastic items, aluminium foil or dishes on the hot surface as this will cause damage to the hob.

## CLEANING THE OUTSIDE OF THE COOKER

DO NOT use abrasive cleaning materials or scourers on the outside of the cooker as some of the finishes are painted and damage may occur. Regularly wipe over the control panel, oven doors and cooker sides using a soft cloth and liquid detergent.

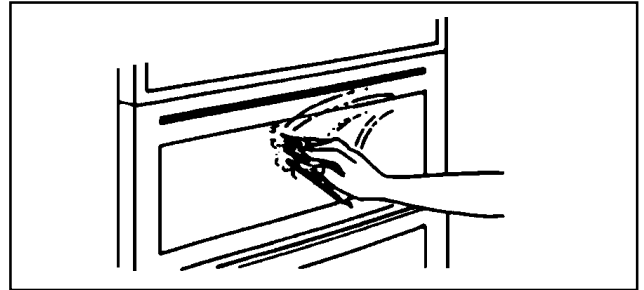

DO NOT ATTEMPT TO REMOVE ANY OF THE CONTROL KNOBS FROM THE PANEL AS THIS MAY CAUSE DAMAGE AND IS A SAFETY HAZARD.

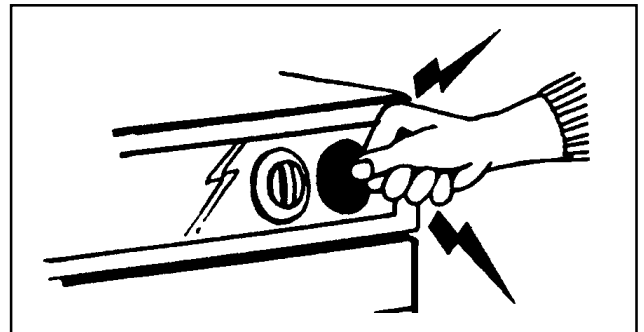

## CLEANING THE GRILL DEFLECTOR, GRILL PAN, GRILL PAN GRID AND OVEN SHELVES

All removable parts, except the grill pan handle can be washed in the dishwasher.

The grill pan, oven shelves and grill deflector may be cleaned using a soap impregnated steel wool pad. The grill pan grid should be cleaned using hot soapy water. Soaking first in soapy water will make cleaning easier.

## CLEANING INSIDE THE OVEN AND GRILL COMPARTMENTS

The sides and back of the oven compartments are coated with Stayclean enamel.

The Stayclean surfaces inside the ovens should not be cleaned manually. See Page 27 'Care of Stayclean Surfaces'.

The vitreous enamel grill compartment base and the fan oven base can be cleaned using normal oven cleaners or aerosol oven cleaners with care. Ensure that the manufacturers instructions are followed and that all parts are well rinsed afterwards.

**Aerosol cleaners must not be used on Stayclean surfaces and must not come into contact with the elements or the door seal as this may cause damage.**

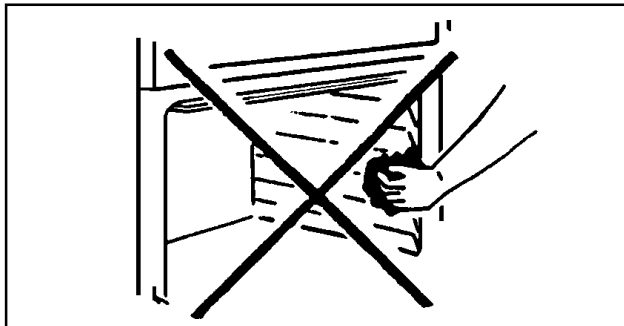

## CARE OF STAYCLEAN SURFACES

Stayclean surfaces destroy splashes of food and fats when the oven temperature is raised to around 220°C.

It is a good idea to run the oven for an hour or two per week to ensure continued good performance from the Stayclean finish.

## HINTS AND TIPS

- Manual cleaning of Stayclean is not recommended. Damage will occur if oven sprays or abrasives of any kind are used.
- Slight discolouration and polishing of the Stayclean surface may occur in time. This DOES NOT affect the Stayclean properties in any way.
- A good time to allow the oven to run on is after the weekly roast. After removing the roast, turn the oven up to 220°C and allow to run for an hour or so. It is important NOT to allow a build-up of soilage as this can prevent the Stayclean from working.
- Follow the recommendations below to keep oven soilage to a minimum.
- Cook at the recommended temperatures. Higher temperatures during roasting will increase soilage. Try cooking at lower temperatures for an increased length of time, you will save energy and often the joint is more tender.
- Use minimal, if any, extra oil or fat when roasting meat, potatoes only require brushing with fat before cooking. Extra fat in the oven during roasting will increase splashing and soilage.

- It is NOT necessary to add water to the meat tin when roasting. The water and the fat juices from the joint create excessive splattering during cooking - even at normal temperatures, as well as causing condensation.
- Covering joints during cooking will also prevent splashing onto the interior surfaces. Removing the covering for the last 20-30 minutes will allow extra browning if required. Some large joints and turkeys especially benefit by this method of cooking, allowing the joint to cook through before the outside is overbrowned.

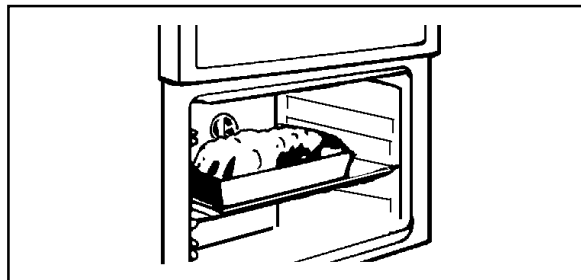

## CLEANING THE DOOR GLASS



To prevent damaging or weakening the door glass panels avoid the use of the following:

- Household detergents and bleaches
- Impregnated pads unsuitable for non-stick saucepans
- Brillo/Ajax pads or steel wool pads
- Chemical oven pads or aerosols
- Rust removers
- Bath/Sink stain removers

## CLEANING BETWEEN THE OUTER AND INNER DOOR GLASS

The outer door glass is removable for cleaning.

### TO REMOVE THE OUTER GLASS

1. Open the oven door slightly to gain access to the two cross head screws on the top of the oven door.
2. Loosen the two screws using a Pozidrive screwdriver.
3. Hold the door glass securely in place with one hand before removing the screws completely with the other hand.
4. Using both hands, gently tilt the top of the door glass towards you, lift slightly to disengage the locators from the two bottom brackets.

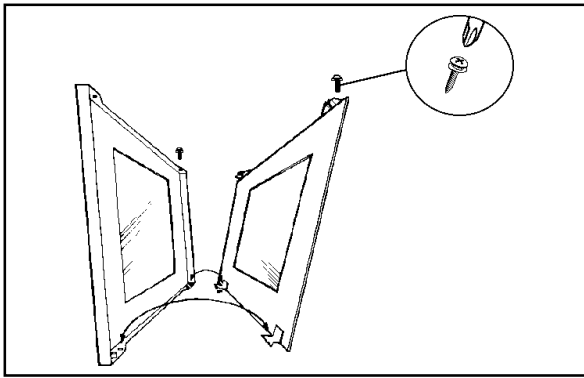

5. Clean the outer and inner glass using hot soapy water or Hob Brite may be used. **DO NOT** try to clean the aluminium foil which is inside the door. The foil is there to help keep the door cool, if it is damaged it will not work. Ensure that all parts are well rinsed and thoroughly dry before attempting to replace the outer door.

### TO REPLACE THE OUTER GLASS

1. Holding the oven glass with both hands, gently place the locators into the holes of the brackets at the bottom of the oven door.
2. Push the top of the oven glass towards the oven door, ensuring the screw location holes line up.
3. Hold the glass in place with one hand and insert the cross head screws into the location holes with the other hand. Give the screws one turn to ensure the glass is secure.
4. Tighten the screws positively with a Pozidrive screwdriver before closing the oven door.

**Do not** attempt to use the oven without the glass being in place.



If the door glass panel becomes chipped or has deep scratches the glass will be weakened and must be replaced to prevent the possibility of the panel shattering. Please contact your local Service Centre who will be pleased to advise further.

### TO CLEAN THE INNER GLASS DOOR PANELS

Clean the inner door glass panels using a soft cloth and hot water to which a little washing up has been added. If the inner panel is heavily soiled, Hob Brite may be used. Do not use abrasive cleaning materials on the door glass. Ensure that all parts are well rinsed and thoroughly dried before attempting to replace the glass.

### REPLACING THE OVEN LIGHT BULB

The type of bulb required is a 300C 25 watt small Edison Screw. Part number 572 491 5431-00/1. (Available through Tricity Bendix service centres).

**CAUTION:** Disconnect the appliance from the electricity supply before replacing the bulb.

Open door and remove the shelves to enable easy access to the oven light assembly. Insert a flat blade screwdriver between the oven side and the glass which covers the bulb.

Support the glass with your hand and prise out sufficiently to release the glass cover. Unscrew the bulb in an anticlockwise direction until it is possible to remove the bulb with ease.

Fit the new bulb by turning in a clockwise direction until it is secure. Ensuring the indent to the flange is pointing to the rear of the oven, replace the glass by pushing it firmly into the hole to cover the bulb assembly.

Replace the shelves. Restore the electricity supply and adjust the time of day and clock as necessary.

## SOMETHING NOT WORKING?

We strongly recommend that you carry out the following checks on your cooker before calling a Service Engineer. It may be that the problem is a simple one which you can solve yourself without the expense of a service call.

If our Service Engineer finds that the problem is listed below you will be charged for the call whether or not the cooker is under guarantee.

### The cooker does not work at all:

- \* Check that the cooker has been wired in and is switched on at the wall.
- \* Check that the main cooker fuse is working.
- \* Check that the timer is set to manual (see page 12).

### The grill and hotplates work but the oven does not:

- \* Check that the timer is set to manual operation (see page 12).

### The oven temperature is too high or low:

- \* Check that the recommended temperatures are being used (see page 22). Be prepared to adjust up or down by 10°C to achieve the results you want.

### The hotplates and ovens work but the grill does not:

- \* Check that you have carefully followed the instructions for operation of the grill.
- \* If the cooling fan fails the grill will not operate. Please call your Customer Service Centre.

### If the oven is not cooking evenly or the side opening door will not stay open:

- \* Check that the cooker is level.

### The oven light fails to illuminate:

- \* Check that the cooker is not set for automatic cooking. The light will illuminate when the cook time begins.
- \* If you have had your cooker for several months you may need to replace the light bulb (see page 28).

### The oven fan is noisy:

- \* Check that the oven is level.
- \* Check that bakeware and shelves are not vibrating in contact with the back panel in the oven.

# SERVICE AND SPARE PARTS



In the event of your appliance requiring service, or if you wish to purchase spare parts please contact your local Tricity Bendix Service Force Centre by telephoning:

**0870 5 929929**

Your call will be routed to the Service Force Centre covering your post code area. The address of your local Service Force Centre is detailed on pages 31 - 32.

For Service in the **Republic of Ireland** contact  
Tricity Bendix  
Long Mile Road  
Dublin 12

Telephone: 01 4090754

Before calling out an engineer, please ensure you have read the details under the heading 'If Something Doesn't Work'.

When you contact the Service Centre you will need to give the following details:

1. Your name, address and post code
2. Your telephone number
3. Clear and concise details of the fault
4. The model, product and serial number of the appliance (found on the rating plate)
5. The purchase date

## CUSTOMER CARE DEPARTMENT

For general enquiries concerning your Tricity Bendix appliance, or further information on Tricity Bendix products, you are invited to contact our Customer Care Department by letter or telephone as follows:

Customer Care Department  
Tricity Bendix Domestic Appliances Limited  
PO Box 47  
Newbury  
Berkshire RG14 5XL

Tel: 01635 572700  
Fax: 01635 42970

To contact your local Tricity Bendix Service Centre telephone **0870 5 929929**

### CHANNEL ISLANDS

GUERNSEY	Guernsey Electricity PO Box 4 Vale, Guernsey Channel Islands
JERSEY	Jersey Electricity Company PO Box 45 Queens Road St Helier Jersey Channel Islands JE4 8NY

### SCOTLAND

ABERDEEN (M05)	54 Claremont Street Aberdeen AB10 6RA
AUCHTERMUCHY (M03)	33A Burnside Auchtermuchy Fife KY14 7AJ
BLANTYRE (M07)	Unit 5 Block 2 Auchenraith Ind Estate Rosendale Way Blantyre G72 0NJ
DUMFRIES (M01)	93 Irish Street Dumfries Scotland DG1 2PQ
DUNOON (M67)	Briar Hill 7 Hill Street, Dunoon Argyll PA23 7AL
GLASGOW (M04)	20 Cunningham Road Clyde Estate Rutherglen, Glasgow, G73 1PP
INVERNESS (M06)	Unit 3B Smithton Indust. Est. Smithton Inverness IV1 AJ
ISLE OF ARRAN  (OWN SALES)	Arran Domestics Unit 4 The Douglas Centre Brodict Isle of Arran KA27 8AJ
ISLE OF BARRA  (OWN SALES)	J Zerfah 244 Bruernish Isle of Barra Western Islands HS9 5QY
ISLE OF BUTE (M66)	Walker Engineering Glenmhor Upper Serpentine Road Rothsay Isle of Bute PA20 9EH
ISLE OF LEWIS (M69)	ND Macleod 16 James Street Stornoway Isle of Lewis PA87 2QW
KELSO (M08)	2-8 Wood Market Kelso Borders TD5 7AX

ORKNEY (M65)	Corsie Domestics 7 King Street Kirkwall Orkney KW15
PERTH	Hydro Electric Inveralmond House Ruthvenfield Road Perth PH1 3AQ
PERTH	Graham Begg Unit 4 Airport Industrial Estate Wick KW1 4QS
(OWN SALES)	
SHETLAND	Tait Electronic Systems Ltd. Holmsgarth Road Lerwick Shetland ZE1 0PW
(OWN SALES)	
SHETLAND	Bolts Shetland Ltd 26 North Road Lerwick Shetland ZE1 0PE
(OWN SALES)	
WHALSAY	Leask Electrical Harlsdale Symbister, Whalsay Shetland ZE2 9AA
(OWN SALES)	

### NORTHERN IRELAND

BELFAST (M27)	Owenmore House Kilwee Business Park Upper Dunmury Lane Belfast BT17 0HD
------------------	---

### WALES

CARDIFF (M28)	Guardian Industrial Estate Clydesmuir Road Tremorfa, Cardiff CF2 2QS
CLYWD (M14)	Unit 6-7 Coed - Parc Abergele Road Rhuddlan Clwyd Wales LL18 5UG
DYFED (M77)	Maes Y Coen High Mead Llanybydder Dyfed SA40 9UL
HAVERFORDWEST (M75)	Cromlech Lodge Ameriston Haverfordwest SA62 5DS
OSWESTRY (M17)	Plas Ffynnon Warehouse Middleton Road Oswestry SY11 2PP

### NORTH EAST

GATESHEAD (M39)	Unit 356a Dukesway Court Dukesway Team Valley Gateshead NE11 0BH
GRIMSBY (M42)	15 Hainton Avenue Grimsby South Humberside DN32 9AS
HULL (M41)	Unit 1 Boulevard Industrial Estate Hull HU3 4AY
LEEDS (M37)	64-66 Cross Gates Road Leeds LS15 7NN
NEWTON AYCLIFFE (M45)	Unit 16 Gurney Way Aycliffe Ind Estate Newton Aycliffe DL5 6UJ
SHEFFIELD (M38)	Pennine House Roman Ridge Ind. Roman Ridge Road Sheffield S9 1GB

### NORTH WEST

BIRKENHEAD (M11)	1 Kelvin Park Dock Road Birkenhead L41 1LT
CARLISLE (M10)	Unit 7 James Street Workshops James Street Carlisle Cumbria CA2 5AH
ISLE OF MAN (M64)	South Quay Ind Estate Douglas Isle of Man
LIVERPOOL (M15)	Unit 1 Honeys Green Precinct Honeys Green Lane Liverpool L12 9JH
MANCHESTER (M09)	Unit B Central Industrial Estate St Marks Street Bolton BL3 6NR
PRESTON (M13)	Unit 250 Dawson Place Walton Summit Bamber Bridge Preston Lancashire PR5 8AL
STOCKPORT (M16)	Unit 20 Haigh Park Haigh Avenue Stockport SK4 1QR

To contact your local Tricity Bendix Service Centre telephone **0870 5 929929**

### MIDLANDS

BIRMINGHAM (M18)	66 Birch Road East, Wyrley Road Industrial Estate Witton Birmingham B6 7DB
BOURNE (M44)	Manning Road Ind Estate Pinfold Road Bourne PE10 9HT
BRIDGNORTH (M72)	1 Underhill Street Bridgnorth Salop WV16 4BB
GLOUCESTER (M23)	101 Rycroft Street Gloucester GL1 4NB
HEREFORD (M31)	Unit 3 Bank Buildings Cattle Market Hereford HE4 9HX
HIGHAMFERRERS (M51)	30 High Street Higham Ferrers Northants NN10 8BB
ILKESTON (M43)	Unit 2 Furnace Road Ilkeston DE7 5EP
LEICESTER (M22)	Unit 7 Oaks Industrial Estate Coventry Road Narborough Leicestershire LE0 5GF
LINCOLN (M40)	Unit 8 Stonefield Park Clifton Street Lincoln LN5 8AA
NEWCASTLE UNDER LYME (M12)	18-21 Croft Road Brampton Industrial Estate Newcastle under Lyme Staffordshire ST5 0TW
NUNEATON (M21)	19 Ptarmigan Place Townsend Drive Nuneaton CV11 6RX
REDDITCH (M20)	13 Thornhill Road North Moons Moat Redditch Worcestershire B98 9ND
TAMWORTH (M19)	Unit 3 Sterling Park Claymore Tamworth B77 5DO
WORCESTER (M73)	Unit 1 Northbrook Close Gregorys Mill Ind Estate Worcester WR3 8BP

### LONDON & EAST ANGLIA

BECKENHAM (M79)	11a Gardener Indust Estate Kent House Lane Beckenham Kent BR3 1QZ
CHELMSFORD (M47)	Hanbury Road Widford Ind Estate Chelmsford Essex CM12 3AE
COLINDALE (M53)	Unit 14 Capitol Park Capitol Way Colindale London NW9 0EQ
ELTHAM (M78)	194 Court Road Mottingham Eltham London SE9 4EW
ENFIELD (M49)	284 Alma Road Enfield London EN3 7BB
GRAVESEND (M57)	Unit B4, Imperial Business Estate Gravesend Kent DA11 0DL
HARPENDEN (M46)	Unit 4 Riverside Estate Coldharbour Lane Harpenden AL5 4UN
LETCHWORTH (M50)	16-17 Woodside Ind Est. Works Road Letchworth Herts SG6 1LA
LONDON (M76)	2/4 Royal Lane Yiewsley West Drayton Middlesex UB7 8DL
MAIDENHEAD (M60)	Reform Road Maidenhead Berkshire SL6 8BY
MOLESEY (M61)	10 Island Farm Avenue West Molesey Surrey KT8 2UZ
NEWBURY (M24)	PO Box 5627 Newbury Berkshire RG14 5GF
IPSWICH (M48)	Unit 2B Elton Park Business Centre Hadleigh Road Ipswich IP2 0DD
NORWICH (M52)	2b Trafalgar Street Norwich NR1 3HN
SUNBURY (M63)	Unit 1a The Summit Hanworth Road Hanworth Ind Estate Sunbury on Thames TW16 5D

### SOUTH EAST

ASHFORD (M58)	Unit 2 Bridge Road Business Estate  Bridge Road Ashford Kent TN2 1BB
FLEET (M59)	Unit 1 Redfields Industrial Estate Church Crookham Fleet Hampshire GU13 0RD
HAYWARDS HEATH (M55)	21-25 Bridge Road Haywards Heath Sussex RH16 1UA
TONBRIDGE (M56)	Unit 30 Deacon Trading Estate Morley Road Tonbridge Kent TN9 1RA

### SOUTH WEST

BARNSTAPLE (M30)	P.O. Box 12 Barnstaple North Devon EX31 2YB
BOURNEMOUTH (M26)	63-65 Curzon Road Bournemouth Dorset BH1 4PW
BRIDGEWATER (M35)	6 Hamp Industrial Estate Bridgewater Somerset TA6 3NT
BRISTOL (M25)	11 Eldon Way Eldonwall Trading Bristol Avon BS4 3QQ
EMSWORTH (M33)	266 Main Road Southbourne Emsworth PO10 8JL
ISLE OF WIGHT (M34)	Unit 8 Enterprise Court Ryde Business Park Ryde Isle of Wight PO33 1DB
NEWTON ABBOT (M29)	Unit 2 Zealley Industrial Estate Kingsteignton Newton Abbot S. Devon TQ12 3TD
PLYMOUTH (M32))	16 Faraday Mill Cattedown Plymouth PL4 0ST
REDRUTH (M36)	Unit 7D Pool Industrial Estate Wilson Way, Redruth, Cornwall TR15 3QW



## GUARANTEE CONDITIONS

### Standard guarantee conditions

We, Tricity Bendix, undertake that if within 12 months of the date of the purchase this Tricity Bendix appliance or any part thereof is proved to be defective by reason only of faulty workmanship or materials, we will, at our option repair or replace the same FREE OF CHARGE for labour, materials or carriage on condition that:

- The appliance has been correctly installed and used only on the electricity supply stated on the rating plate.
- The appliance has been used for normal domestic purposes only, and in accordance with the manufacturer's instructions.
- The appliance has not been serviced, maintained, repaired, taken apart or tampered with by any person not authorised by us.
- All service work under this guarantee must be undertaken by a Tricity Bendix service centre.
- Any appliance or defective part replaced shall become the Company's property.
- This guarantee is in addition to your statutory and other legal rights.

Home visits are made between **8.30am** and **5.30pm** Monday to Friday. Visits may be available outside these hours in which case a **premium** will be charged.

### Exclusions

#### This guarantee does not cover:

- Damage or calls resulting from transportation, improper use or neglect, the replacement of any light bulbs or removable parts of glass or plastic.
- Costs incurred for calls to put right an appliance which is improperly installed or calls to appliances outside the United Kingdom.
- Appliances found to be in use within a commercial environment, plus those which are subject to rental agreements.
- Products of Tricity Bendix manufacture which are not marketed by Tricity Bendix.

### European Guarantee

If you should move to another country within Europe then your guarantee moves with you to your new home subject to the following qualifications:

- The guarantee starts from the date you first purchased your product.
- The guarantee is for the same period and to the same extent for labour and parts as exists in the new country of use for this brand or range of products.
- This guarantee relates to you and cannot be transferred to another user.
- Your new home is within the European Community (EC) or European Free Trade Area.
- The product is installed and used in accordance with our instructions and is only used domestically, i.e. a normal household.
- The product is installed taking into account regulations in your new country.

Before you move please contact your nearest Customer Care centre, listed below, to give them details of your new home. They will then ensure that the local Service Organisation is aware of your move and able to look after you and your appliances.

France	Senlis	+33 (0)3 44 62 28 28
Germany	Nürnberg	+49 (0)911 323 2600
Italy	Pordenone	+39 (0)1678 47053
Sweden	Stockholm	+46 (0)20 78 77 50
UK	Newbury	+44 (0)1635 525 542

SIE505 SSE/BZ 311480901



## RATING PLATE REFERENCE

MAKE AND MODEL NO.	SERIAL NO.	PRODUCT NO.	DATE OF PURCHASE

### IMPORTANT NOTICE

In line with our continuing policy of research and development, we reserve the right to alter models and specifications without prior notice.

This handbook is accurate at the date of printing, but will be superseded and should be disregarded if specifications or appearance are changed.



TRICITY BENDIX, PO BOX 47, NEWBURY, BERKSHIRE, RG14 5XL  
TELEPHONE (01635) 525542

MODEL NO.  
**SIE 505 SSE/BZ**



PART NO.  
**311480901**

**1999**

## Free Manuals Download Website

<http://myh66.com>

<http://usermanuals.us>

<http://www.somanuals.com>

<http://www.4manuals.cc>

<http://www.manual-lib.com>

<http://www.404manual.com>

<http://www.luxmanual.com>

<http://aubethermostatmanual.com>

Golf course search by state

<http://golfingnear.com>

Email search by domain

<http://emailbydomain.com>

Auto manuals search

<http://auto.somanuals.com>

TV manuals search

<http://tv.somanuals.com>