

**User  
manual**

**Dishwasher**



TDF 221

# Content

---

Safety information	3
Control panel and functions	4
Programme table	6
Before the first use	7
Setting the water softener	7
Filling with dishwasher salt	10
Filling with rinse aid	11
Adjusting the dosage of rinse aid	11
Loading cutlery and dishes	12
Filling with detergent	14
Unloading the dishwasher	14
Cleaning and care	15
Environmental concerns	16
Something not working	17
Technical data	19
Consumption values	19
Hints for test institutes	20
Installation	21
Service and spare parts	24
Guarantee conditions	25

## Safety information

---

In the interest of your safety and to ensure the correct use, before installing and first using the appliance, read this user manual carefully, including its hints and warnings. To avoid unnecessary mistakes and accidents, it is important to ensure that all people using the appliance are thoroughly familiar with its operation and safety features. Save these instructions and make sure that they remain with the appliance if it is moved or sold, so that everyone using it through its life will be properly informed on appliance use and safety.

### Correct use

- This dishwasher is only intended for washing household utensils suitable for machine washing.
- Do not put any solvents in the dishwasher. This could cause an explosion.
- Knives and other items with sharp points must be loaded in the cutlery basket with their points down or placed in a horizontal position in the upper basket.
- Only use products (detergent, salt and rinse aid) suitable for dishwashers.
- Avoid opening the door whilst the appliance is in operation, hot steam may escape.
- Do not take any dishes out of the dishwasher before the end of the dishwashing cycle.
- After use, isolate the appliance from the power supply and turn off the water supply.
- This product should be serviced only by an authorised service engineer, and only genuine spare parts should be used.
- Ensure that the door of the dishwasher is always closed when it is not being loaded or unloaded. In this way you will avoid anybody tripping over the open door and hurting themselves.
- Do not sit or stand on the open door.

### Child safety

- This appliance is designed to be operated by adults. Don't allow children to use the dishwasher unsupervised.
- Keep all packaging well away from children. There is risk of suffocation.
- Keep all detergents in a safe place out of children's reach.
- Keep children well away from the dishwasher when the door is open.

### Installation

- Check your dishwasher for any transport damage. Never connect a damaged machine. If your dishwasher is damaged contact your supplier.
- All packaging must be removed before use.
- Any electrical and plumbing work required to install this appliance must be carried out by a qualified and competent person.
- For safety reasons it is dangerous to alter the specifications or attempt to modify this product in any way.

### General safety

- Dishwasher detergents can cause chemical burns to eyes, mouth and throat. Could endanger life! Comply with the safety instructions of the dishwasher detergent manufacturer.
- The water in your dishwasher is not for drinking. Detergent residues may still be present in your machine.

- Never use the dishwasher if the electrical supply cable and water hoses are damaged; or if the control panel, work top or plinth area are damaged such that the inside of the appliance is freely accessible. Contact your local Service Force centre, in order to avoid hazard.
- All sides of the dishwasher must never be drilled to prevent damage to hydraulic and electric components.

**⚠ WARNING!**

For electrical and water connection carefully follow the instructions given in specific paragraphs.

## Control panel and functions

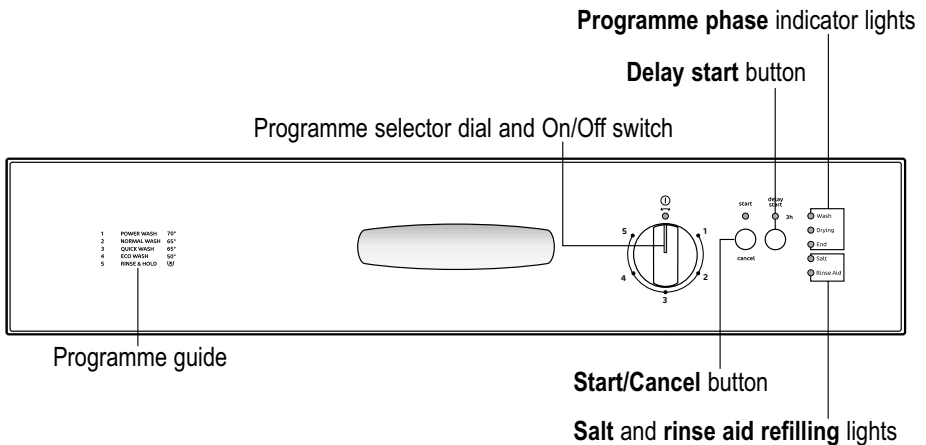

**Programme selector dial and On/Off switch**

- when in this position, the machine is switched off (corresponding light off),
- when the marker on the dial corresponds with a programme, the machine is switched on and a programme is selected (corresponding light on)

- **Starting the washing programme:**

1. Select a washing programme.
2. Press the start / cancel button (corresponding light on).

**IMPORTANT!**

Once the programme has started, if you want to change the selection made you must cancel the washing programme in progress.

- **Cancel the washing programme in progress:**

1. Press and hold the start / cancel button until the corresponding light turns off.
2. Release the start / cancel button.
3. Turn the programme selector dial to the Off position or select a new washing programme (check that there is detergent in the detergent dispenser).

**Start / cancel** button

This option allows the start of the programme to be delayed by 3 hours.

Once the washing programme has been set, press the **delay start** button. The corresponding indicator light illuminates.

Press the start / cancel button, the countdown of the delay start begins automatically.

Once the countdown has elapsed the washing programme will start automatically. The delay start indicator light turns off.

**Cancel the delay start in progress:**

press and hold the start / cancel button until the start / cancel and delay start indicator lights turn off.

To start the washing programme press the start / cancel button.

**Delay start** button

**Wash light**

Illuminates when the washing and rinsing phases are running.

**Drying light**

Illuminates when the drying phase is running.

**End light**

Illuminates when the washing programme has ended. Switch off the dishwasher by returning the programme selector dial to the Off position. The On/Off light turns off.

It also has added functions of visual signalling as:

- the setting of the water softener,
- intervention of an alarm due to the malfunction of the machine.

**Salt refilling light**

Illuminates when special salt needs to be filled.

It can remain illuminated several hours after the salt has been filled.

**Rinse aid refilling light**

Illuminates when rinse aid needs to be filled.

## Programme table

Programme	Use	Cycle description
<b>POWER WASH 70°</b> 1	Heavy soil. Crockery, cutlery, pots and pans	Prewash - Main wash 2 intermediate rinses - Final rinse - Dry
<b>NORMAL WASH 65°</b> 2	Normal soil. Crockery and cutlery	Prewash - Main wash 2 intermediate rinses - Final rinse - Dry
<b>QUICK WASH 65°</b> 3	Light soil. Crockery and cutlery	Main wash- Final rinse
<b>ECO WASH 50°</b> 4	Normal soil. Crockery and cutlery	Prewash - Main wash 1 intermediate rinse - Final rinse - Dry
<b>RINSE &amp; HOLD</b>  5	Any. Partial load (to be completed later in the day). This programme does not require the use of detergent.	Prewash

## Before the first use

---

### When using separate special (dishwasher) salt, rinse aid and detergent:

- set the water softener
- add special (dishwasher) salt
- fill up with rinse aid

### When using tablets that integrate rinse aid and detergent:

there is no need to fill up with rinse aid

- set the water softener
- add special (dishwasher) salt

### When using tablets that integrate rinse aid, detergent, salt function and other additives:

there is no need to fill up with special salt or rinse aid.

Check whether these detergents are suitable for your water hardness. Follow the manufacturers instructions.

- Set the water hardness to level 1.

### **IMPORTANT!**

If the drying results are not satisfactory we recommend that you:

1. Fill up the rinse aid dispenser with rinse aid.
2. Set the rinse aid dosage to position 2.

If you decide in future to use separated detergents, we advise that you:

- Fill up the salt and rinse aid container.
- Adjust the water hardness setting to the highest level and perform 1 normal washing programme without loading any dishes.
- Adjust the water hardness setting according to the hardness of the water in your area.
- Adjust the rinse aid dosage

## Setting the water softener

---

The dishwasher is equipped with a water softener designed to remove minerals and salts from the water supply, which would have a detrimental or adverse effect on the operation of the appliance.

The softener should be adjusted according to the hardness of the water in your area. Your local Water Authority can advise you on the hardness of the water in your area.

### **IMPORTANT!**

The water softener must be set in both ways: manually and electronically.

Water hardness			Number of flashes of the “end of programme” light	Adjustment of the water hardness setting	
in Clarke <sup>1)</sup>	in °TH <sup>2)</sup>	in mmol/l <sup>3)</sup>		manually	electronically
64 - 88	91 - 125	9,0 - 12,5	10	2	level 10
53 - 63	76 - 90	7,6 - 8,9	9	2	level 9
46 - 52	65 - 75	6,5 - 7,5	8	2	level 8
36 - 45	51 - 64	5,1 - 6,4	7	2	level 7
28 - 35	40 - 50	4,0 - 5,0	6	2	level 6
23 - 27	33 - 39	3,3 - 3,9	5	2	level 5 <small>factory setting</small>
18 - 22	26 - 32	2,6 - 3,2	4	1	level 4
13 - 17	19 - 25	1,9 - 2,5	3	1	level 3
5 - 12	7 - 18	0,7 - 1,8	2	1	level 2
< 5	< 7	< 0,7	1	1	level 1 no salt necessary

- 1) Clarke degree, measure of the water hardness.
- 2) (°TH) French degree, measure of the water hardness.
- 3) (mmol/l) millimol per litre, international unit for water hardness

## Setting the water softener manually (see table)

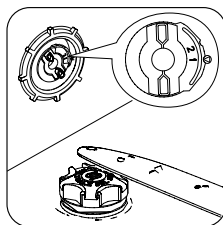
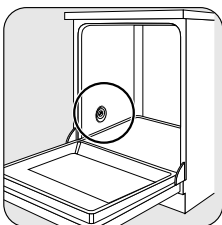

The water softener is factory set at position 2.

Set switch to position 1  
or 2



## Setting the water softener electronically (see table)

The water softener is factory set at position 5.

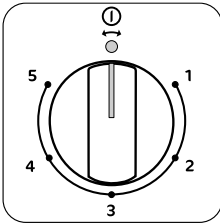

The dishwasher must be switched off

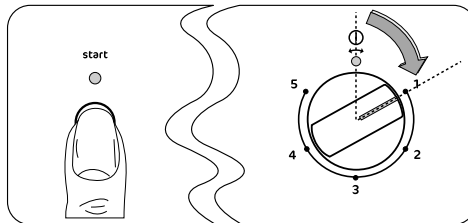

Press and hold the **start / cancel** button and turn the programme selector dial clockwise till the first programme. Keep the button pressed until the programme selector light and the **start / cancel** light start flashing.

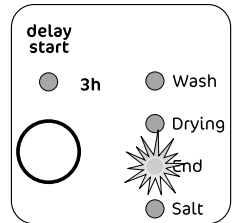

Release the button. The **End** light will flash. The number of flashes corresponds to current level set.

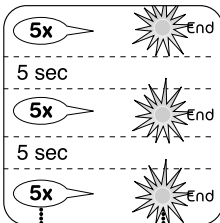

The **End** light might flash 5 times, for example. The flashing is repeated every 5 seconds.

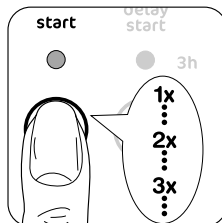

To change the level, press the **start / cancel** button. Each time the button is pressed the level increases. (Level 1 follows level 10).

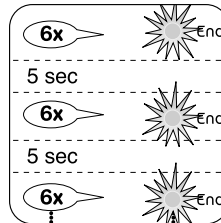

The **End** light indicates the new setting.

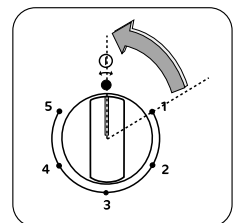

To memorise the operation, turn the programme selector dial to position off.

# Filling with dishwasher salt

## **CAUTION!**

Use only special salt suitable for dishwashers

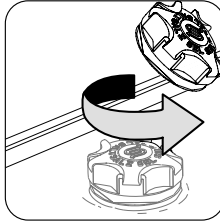
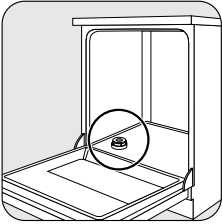

**Only before filling with salt for the first time,** fill the salt container with water

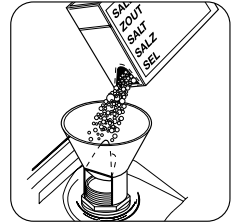

Using the funnel provided, pour in the salt until the container is filled with salt.

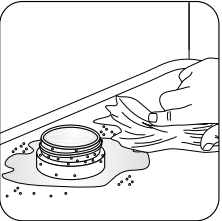

Remove any trace of salt.

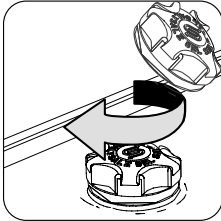

Replace the cap tightly turning it clockwise until it stops with a click.

## **IMPORTANT!**

Immediately start a complete programme.

## **IMPORTANT!**

Top up the special salt when the light on the control panel illuminates.

## **IMPORTANT!**

Water will overflow from the container as salt is added.

## Filling with rinse aid

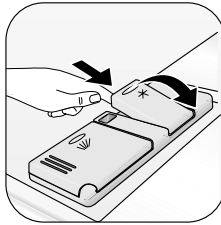
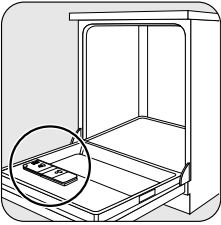

Open the lid.

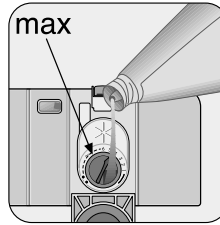

Fill up with rinse aid. The maximum level for filling is indicated by "max".



Clean up any rinse aid which overflows. Close the lid and press until it locks.

### **IMPORTANT!**

Top up the rinse aid when the light on the control panel illuminates.

### **! CAUTION!**

Never fill the rinse aid dispenser with any other substances (e.g. dishwasher cleaning agent, liquid detergent). This would damage the appliance.

## Adjusting the dosage of rinse aid

Increase the dose if there are drops of water or lime spots on the dishes after washing.

Reduce the dose if there are whitish streaks on the dishes or a bluish film on glassware or knife blades.

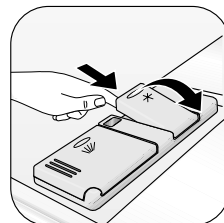
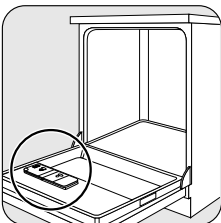

Open the lid.

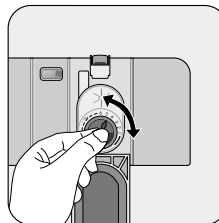

Set the dosage level. (The dose is factory set in position 4).

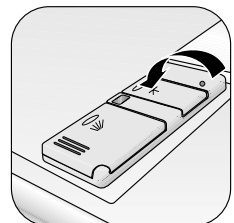

Close the lid and press until it locks.

## Loading cutlery and dishes

- The following items are not suitable for use in the dishwasher:
  - Cutlery with wooden, horn, china or mother-of-pearl handles
  - Plastic items that are not heat resistant
  - Older cutlery with glued parts that are not temperature resistant
  - Bonded cutlery items or dishes
  - Pewter or copper items
  - Lead crystal glass
  - Steel items prone to rusting
  - Wooden platters
  - Items made from synthetic fibres
- When loading the dishwasher, make sure that you:
  - Remove all left over food and debris.
  - Soften remnants of burnt food in pans
  - Load hollow items such as cups, glasses, pans, etc. with the opening downwards so that water cannot collect in the container or a deep base.
  - Dishes and items of cutlery must not lie inside one another, or cover each other.
  - To avoid damage to glasses, they must not touch.
  - Lay small objects in the cutlery basket.
- **Plastic items and pans with teflon have a tendency to retain water drops; these items will not dry as well as porcelain and steel items.**

### **IMPORTANT!**

Before closing the door, ensure that the spray arms can rotate freely.

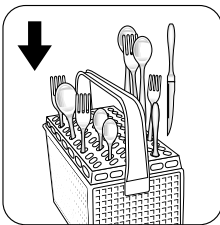

Load cutlery.  
For best results we recommend you to use the cutlery grid provided (if the size and dimensions of the cutlery allow it).

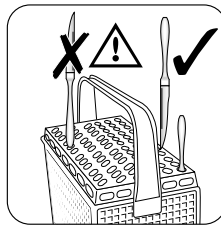

Place knives and other items of cutlery with sharp points or edges with their handles facing upwards.  
Risk of injury!

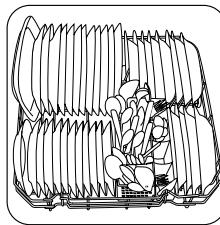

Load the lower basket.  
Arrange serving dishes and large lids around the edge of the basket.

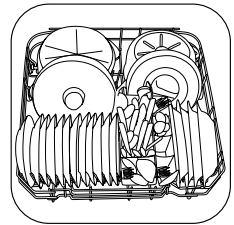

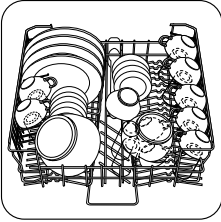

Load upper basket. Light items (plastic bowls etc.) must be loaded in the upper basket and arranged so they do not move.

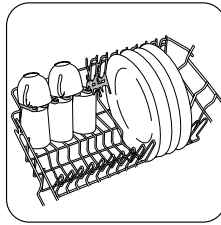

For taller items, the cup racks can be folded upwards.

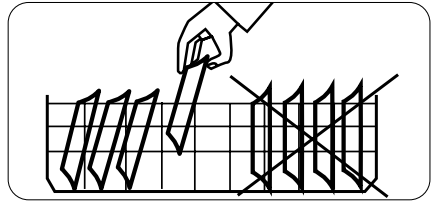

**If plates are to be loaded in the upper basket:** load them starting from the rear positions; tilting them slightly forwards and avoiding the front positions near the door.

## Adjusting the height of the upper basket

If washing very large plates you can load them in the lower basket after moving the upper basket to the higher position.

	Maximum height of the dishes in:	
	upper basket	lower basket
With upper basket raised	20 cm	31 cm
With upper basket lowered	24 cm	27 cm

**To move to the higher position proceed as follows:**

1. Pull out the basket until it stops.
2. Carefully lift both sides upwards until the mechanism is engaged and the basket is stable.

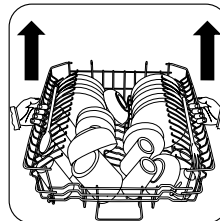

**To lower the basket to the original position proceed as follows:**

1. Pull out the basket until it stops.
2. Carefully lift both sides upwards and then allow the mechanism to drop back down slowly, keeping hold of it.

### **IMPORTANT!**

Never lift or lower the basket on one side only

### **IMPORTANT!**

When the basket is in the higher position you will not be able to use the cup racks.

# Filling with detergent

## IMPORTANT!

Only use detergents suitable for dishwashers.  
Observe the manufacturer's dosing and storage recommendations.

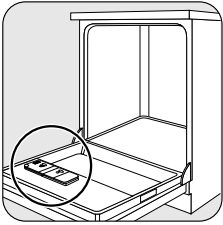

Open the lid.

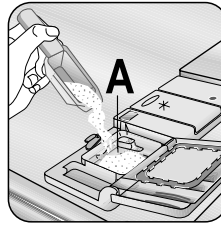

Fill in the detergent in compartment A.

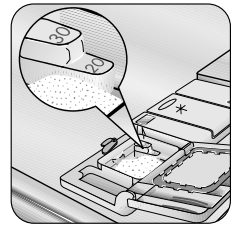

Observe the dosing levels.

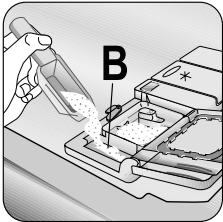

For programmes with prewash add an additional detergent dose in compartment B.

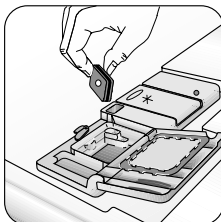

When using detergent tablets: place detergent tablets in compartment A.



Close the lid.

# Unloading the dishwasher

## IMPORTANT!

Open the dishwasher's door, leave it ajar and wait a few minutes before removing the dishes; hot dishes are sensitive to knocks. In this way they will be cooler and the drying will be improved.

- Empty the lower basket first and then the upper one; this will avoid water dripping from the upper basket onto the dishes in the lower one.
- Water may appear on the sides and the door of the dishwasher as the stainless steel will eventually become cooler than the dishes.

## Cleaning and care

### Cleaning the filters

#### IMPORTANT!

NEVER use the dishwasher without filters.

Incorrect repositioning and fitting of the filters will produce poor washing results.

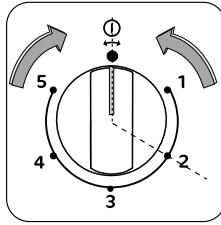
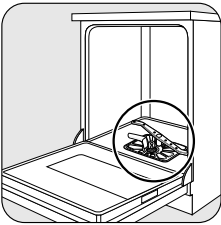

The dishwasher must be switched off

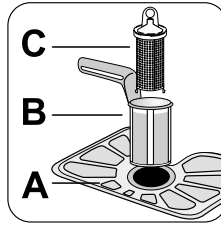

Clean filters **A**, **B** and **C** thoroughly under running water.

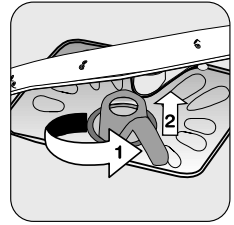

Turn the handle about  $\frac{1}{4}$  turn anticlockwise and remove filters **B** and **C**.

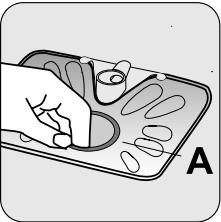

Remove filter **A** from the base of the washing compartment.

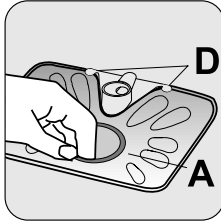

Put the flat filter **A** back in the base of the washing compartment and ensure that it fits perfectly under the two guides **D**.

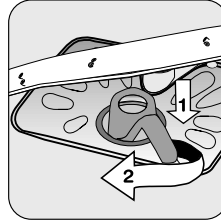

Replace the filters and lock by turning the handle clockwise to the stop.

#### IMPORTANT!

NEVER try to remove the spray arms.

If residues of soil have clogged the holes in the upper spray arm, remove them with a toothpick.

## External cleaning

Clean the external surfaces of the machine and control panel with a damp soft cloth. If necessary use only neutral detergents. Never use abrasive products, scouring pads or solvent (acetone, trichloroethylene etc....). Ensure that the seals around the door, the detergent and rinse aid dispensers are cleaned regularly with a damp cloth. We recommend every 3 months to run a 65°C wash programme without dishes using detergent.

## Prolonged periods of non-operation

If you are not using the machine for any period of time you are advised to:

1. Unplug the appliance and then turn off the water.
2. Leave the door ajar to prevent the formation of any unpleasant smells.
3. Leave the inside of the machine clean.

## Environmental concerns

### Packaging material

The packaging materials are environmentally friendly and can be recycled. The plastic components are identified by markings, e.g. >PE<, >PS<, etc. Please dispose of the packaging materials in the appropriate container at the community waste disposal facilities.

### **WARNING!**

When a unit is no longer being used:

- Pull the plug out of the socket.
- Cut off the cable and plug and dispose of them.
- Dispose of the door catch.  
This prevents children from trapping themselves inside and endangering their lives.

## Frost precautions

Avoid placing the machine in a location where the temperature is below 0°C. If this is unavoidable, empty the machine, close the appliance door, disconnect the water inlet pipe and empty it.

## Moving the machine

If you have to move the machine (moving house etc....):

1. Unplug it.
2. Turn the water tap off.
3. Remove the water inlet and discharge hoses.
4. Pull the machine out together with the hoses.
5. Only transport the dishwasher in an upright position, otherwise salt water may run out.

## Old appliance

The symbol  on the product or on its packaging indicates that this product may not be treated as household waste. Instead it shall be handed over to the applicable collection point for the recycling of electrical and electronic equipment. By ensuring this product is disposed of correctly, you will help prevent potential negative consequences for the environment and human health, which could otherwise be caused by inappropriate waste handling of this product.

For more detailed information about recycling of this product, please contact your local city office, your household waste disposal service or the shop where you purchased the product.



## Something not working

### IMPORTANT!

The dishwasher will not start or stops during operation.

Certain problems are due to the lack of simple maintenance or oversights, which can be solved with the help of the indications described in the chart, without calling out an engineer.

Switch off the dishwasher, open the door and carry out the following suggested corrective actions.

Fault code / malfunction	Possible cause	Solution
The dishwasher does not fill with water. - <b>continuous flashing of the start / cancel light</b> - <b>1 flash of the "End" light</b>	The water tap is blocked or furred with limescale. The water tap is turned off. The filter (where present) in the threaded hose fitting at the water inlet valve is blocked. The water inlet hose has not been correctly laid or it is bent or squashed.	Clean the water tap.  Turn the water tap on. Clean the filter in the threaded hose fitting.  Check the water inlet hose connection.
The dishwasher will not drain. - <b>continuous flashing of the start/cancel light</b> - <b>2 flashes of the "End" light</b>	The sink spigot is blocked.  The water drain hose has not been correctly laid or it is bent or squashed.	Clean out the sink spigot.  Check the water drain hose connection.
- <b>continuous flashing of the start / cancel light</b> - <b>3 flashes of the "End" light</b>	Anti-flood device is activated.	Close the water tap and contact your local Service Force Centre.
The programme does not start.	The dishwasher door has not been properly closed.	Close the door
	The main plug is not plugged in.	Insert the mains plug
	The fuse has blown in the household fuse box.	Replace the fuse.

Once these checks have been carried out; close the door, switch on the dishwasher and press the **start / cancel** button. The programme will continue from the point at which it was interrupted. If the malfunction or fault code reappears contact the Service Force Centre.

For other combinations of fault codes not described in the above chart, please contact your Service Force Centre.

## The wash results are not satisfactory

<p>The dishes are not clean</p>	<ul style="list-style-type: none"> <li>● The wrong washing programme has been selected.</li> <li>● The dishes were arranged in such a way as to stop water reaching all parts of the surface. The baskets must not be overloaded.</li> <li>● The spray arm do not rotate freely due to incorrect arrangement of the load.</li> <li>● The filters in the base of the washing compartment are dirty or incorrectly positioned.</li> <li>● Too little or no detergent has been used.</li> <li>● Where there are limescale deposits on the dishes; the salt container is empty or the incorrect level of the water softener has been set.</li> <li>● The drain hose connection is not correct.</li> <li>● The salt container cap is not properly closed.</li> </ul>
<p>The dishes are wet and dull</p>	<ul style="list-style-type: none"> <li>● Rinse aid was not used.</li> <li>● The rinse aid dispenser is empty.</li> </ul>
<p>There are streaks, milky spots or a bluish coating on glasses and dishes</p>	<ul style="list-style-type: none"> <li>● Decrease rinse aid dosing.</li> </ul>
<p>Water drops have dried onto glasses and dishes</p>	<ul style="list-style-type: none"> <li>● Increase rinse aid dosing.</li> <li>● The detergent may be the cause, Contact the detergent manufacturer's consumer care line.</li> </ul>

If after all these checks, the problem persists, contact your local Service Force Centre, quoting the model (Mod.), product number (PNC) and serial number (S.N.). This information can be found on the rating plate located on the side of the dishwasher door (see picture).

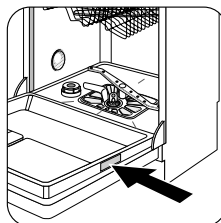

So that you always have these numbers at hand, we recommend you to make a note of them here:

Mod. : .....  
 PNC : .....  
 S.N. : .....

## Technical data

Dimensions	Width Height Depth.	60 cm 85 cm 61 cm
Electrical connection Voltage - Overall power - Fuse	Information on the electrical connection is given on the rating plate on the inner edge of the dishwasher's door.	
Water supply pressure	Minimum Maximum	0,05 MPa (0.5 bar) 0,8 MPa (8 bar)
Capacity	12 place settings	
Max. weight	41	
Noise level	51 dB (A)	

## Consumption values

The consumption values are intended as a guide and depends on the pressure and the temperature of the water and also by the variations of the power supply and the amount of dishes.

Programme	Programme duration (minutes)	Energy (kWh)	Water (litres)
<b>POWER WASH 70°</b>	85 - 95	1,7 - 1,9	23 - 25
<b>NORMAL WASH 65°</b>	108 - 118	1,7 - 1,8	24 - 26
<b>QUICK WASH 65°</b>	25 - 35	0,7 - 0,8	8
<b>ECO WASH 50°</b> (Test programme for Test Institutes)	140	1,05	18
<b>RINSE &amp; HOLD</b>	12	< 0,1	4

## Hints for test institutes

Testing in accordance with **EN 60704** must be carried out with appliance fully loaded and using the test programme (see "Consumption values").

Test in accordance with **EN 50242** must be carried out when the salt container and rinse aid dispenser have been filled with salt and rinse aid respectively and using the test programme (see "Consumption values").

	Full load: 12 standard place settings
Amount of detergent required:	5 g + 25 g (Type B)
Rinse aid setting:	position 4 (Type III)



Upper basket



Cutlery basket



Lower basket

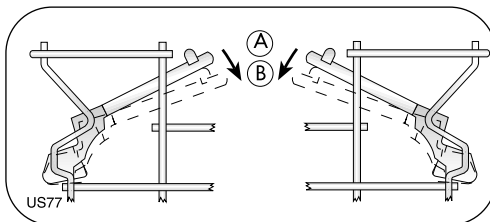

Cup racks: position A

## Installation

### **WARNING!**

Any electrical and/or plumbing work required to install this appliance should be carried out by a qualified electrician and/or plumber or competent person.

## Water connection

### **WARNING!**

The dishwasher must not be connected to open water appliances or instantaneous water heaters. This dishwasher must be fed with cold water.

### **WARNING!**

Only use, for connection to the water mains, new hose-set; old hose-set must not be reused.

### **CAUTION!**

If the machine is connected to new pipes or pipes which have not been used for a long time, you should run the water for a few minutes before connecting the inlet hose.

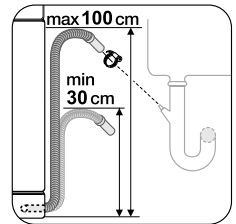
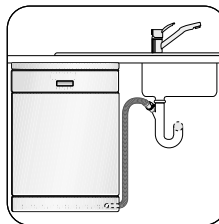
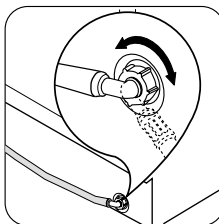
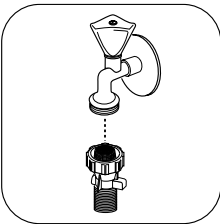

## Inlet hose

Connect the inlet hose to a water tap with an external thread of 3/4".

The inlet hose can be turned either to the left or the right to suit the installation by means of the locknut.

The locknut must be correctly fitted to avoid water leaks.

## Drain hose

- Connect drain hose to the sink. Secure it with the supplied hose clamp.
- Required height: 30 to 100 cm above bottom of the dishwasher.
- If you use a drain hose extension the total length should not be longer than 4 metres. Likewise the internal diameter of the couplings used for connections to the waste outlet must be no smaller than the diameter of the hose provided.

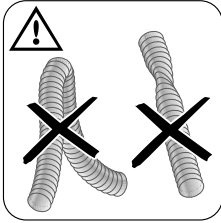

Ensure that the hoses are not kinked, crushed or entangled.

### **CAUTION!**

Always be sure, that there is no water leakage from hoses and their connections after the installation.

## Electrical connection

### **WARNING!**

Safety standards require the appliance to be earthed. The manufacturer accepts no liability for failure to observe the above safety precautions.

Prior to using the appliance for the first time, ensure that the rated voltage and type of supply on the rating plate match that of the supply where the appliance is to be installed. The fuse rating is also to be found on the rating plate.

Always plug the mains plug into a correctly installed shockproof socket.

### **WARNING!**

Multi-way plugs, connectors and extension cables must not be used. This could constitute a fire hazard through overheating.

If necessary, have the domestic wiring system socket replaced. In case that the electrical cable has to be replaced, contact your local Service Force centre.

The plug must be accessible after the appliance has been installed.

Never unplug the appliance by pulling on the cable. Always pull the plug.

## Fitting under a counter

By removing the dishwasher's worktop, you can install it under a close fitting sink unit or a pre-existing top.

Be sure that once the appliance has been installed, it is easily accessible for the service engineer in the event that a repair is required.

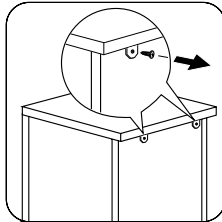
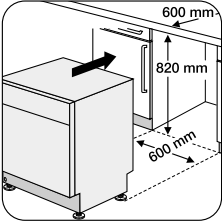

Unscrew the two screws at the rear.

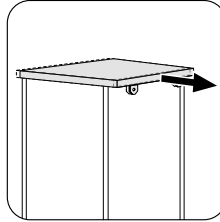

Push the top backwards about 1 cm.

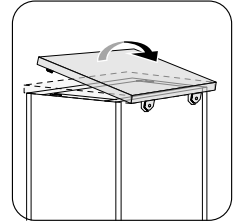

Lift top at the front and remove it.

## Levelling

Good levelling is essential for correct closure and sealing of the door. When the appliance is correctly levelled, the door will not catch on either side of the cabinet.



Check if the dishwasher is levelled.

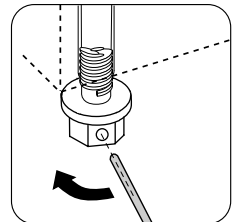

If not, loosen or tighten the adjustable feet until the appliance is perfectly levelled.

## Service and spare parts

**SERVICE FORCE**

In the event of your appliance requiring service, or if you wish to purchase spare parts please contact your local Service Force Centre by telephoning:

**08705 929929**

Your telephone call will be automatically routed to the Service Force Centre covering your post code area.

For the address of your local Service Force Centre and further information about Service Force, please visit the website at [www.serviceforce.co.uk](http://www.serviceforce.co.uk)

Before calling out an engineer, please ensure you read the details under the heading "Something not working".

When you contact the Service Force Centre you will need to give the following details:

1. Your name, address and post code
2. Your telephone number
3. Clear and concise details of the fault
4. The model and serial number of the appliance (found on the rating plate)
5. The purchase date

**Please note that a valid purchase receipt or guarantee documentation is required for in-guarantee service calls.**

For Customer Service in The Republic of Ireland please contact us at the address below:

Electrolux Group (Irl) Ltd

Long Mile Road

Dublin 12

Republic of Ireland

Tel: + 353 (0)1 4090751

Email: [service.eid@electrolux.ie](mailto:service.eid@electrolux.ie)

## Customer Care Department

For general enquiries concerning your Tricity Bendix appliance or for further information on Tricity Bendix products please contact our Customer Care Department by letter or telephone at the address below or visit our website at [www.tricity-bendix.co.uk](http://www.tricity-bendix.co.uk)

Customer Care Department

### Major Appliances

Tricity Bendix  
Addington Way  
Luton  
Bedfordshire  
LU4 9QQ

Tel: 08705 950950 (\*)

*\* calls to this number may be recorded for training purposes*



## Guarantee conditions

---

### Standard Guarantee Conditions

We, Tricity Bendix, undertake that if within 12 months of the date of purchase this Tricity Bendix appliance or any part thereof is proved to be defective by reason only of faulty workmanship or materials, we will, at our option repair or replace the same **FREE OF CHARGE** for labour, materials or carriage on condition that:

- The appliance has been correctly installed and used only on the electricity supply stated on the rating plate.
- The appliance has been used for normal domestic purposes only, and in accordance with the manufacturer's instructions.
- The appliance has not been serviced, maintained repaired, taken apart or tampered with by any person not authorised by us.
- All service work under this guarantee must be undertaken by a Service Force Centre.
- Any appliance or defective part replaced shall become the Company's property.
- This guarantee is in addition to your statutory and other legal rights.

Home visits are made between **8.30am** and **5.30pm** Monday to Friday. Visits may be available outside these hours in which case a **premium** will be charged.

### Exclusions

**This guarantee does not cover:**

- Damage or calls resulting from transportation, improper use or neglect, the replacement of any light bulbs or removable parts of glass or plastic.
- Costs incurred for calls to put right an appliance which is improperly installed or calls to appliances outside the United Kingdom.
- Appliances found to be in use within a commercial environment, plus those which are subject to rental agreements.
- Products of Tricity Bendix manufacture which are not marketed by Tricity Bendix.



## European guarantee

This appliance is guaranteed by Electrolux, in each of the countries listed in the following page, for the period specified in the appliance guarantee or otherwise by law. If you move from one of these countries to another of these countries the appliance guarantee will move with you subject to the following qualifications:

- The appliance guarantee starts from the date you first purchased the appliance which will be evidenced by production of a valid purchase document issued by seller of the appliance.
- The appliance guarantee is for the same period and to the same extent for labour and parts as exists in your country of residence for this particular model or range of appliances.
- The appliance guarantee is personal to the original purchaser of the appliance and cannot be transferred to another user.
- The appliance is installed and used in accordance with instructions issued by Electrolux and is only used within the home, i.e. is not used for commercial purposes.
- The appliance is installed in accordance with all relevant regulations in force within your new country of residence.

The provisions of this European Guarantee do not affect any of the rights granted to you by law.

[www.electrolux.com](http://www.electrolux.com)

		
Albania	+35 5 4 261 450	Rr. Pjeter Bogdani Nr. 7 Tirane
Belgique/België/Belgien	+32 2 363 04 44	Bergensesteenweg 719, 1502 Lembeek
Česká republika	+420 2 61 12 61 12	Budějovická 3, Praha 4, 140 21
Danmark	+45 70 11 74 00	Sjællandsgade 2, 7000 Fredericia
Deutschland	+49 180 32 26 622	Muggenhofer Str. 135, 90429 Nürnberg
Eesti	+37 2 66 50 030	Mustamäe tee 24, 10621 Tallinn
España	+34 902 11 63 88	Carretera M-300, Km. 29,900 Alcalá de Henares Madrid
France	<a href="http://www.electrolux.fr">www.electrolux.fr</a>	
Great Britain	+44 8705 929 929	Addington Way, Luton, Bedfordshire LU4 9QQ
Hellas	+30 23 10 56 19 70	4 Limnou Str., 54627 Thessaloniki
Hrvatska	+385 1 63 23 338	Slavonska avenija 3, 10000 Zagreb
Ireland	+353 1 40 90 753	Long Mile Road Dublin 12
Italia	+39 (0) 434 558500	C.so Lino Zanussi, 26 - 33080 Porcia (PN)
Latvija	+37 17 84 59 34	Kr. Barona iela 130/2, LV-1012, Riga
Lietuva	+370 5 27 80 609	Verkių 29, LT-09108 Vilnius
Luxembourg	+35 2 42 43 13 01	Rue de Bitbourg, 7, L-1273 Hamm
Magyarország	+36 1 252 1773	H-1142 Budapest XIV, Erzsébet királyné útja 87
Nederland	+31 17 24 68 300	Vennootsweg 1, 2404 CG - Alphen aan den Rijn
Norge	+47 81 5 30 222	Risløkkvn. 2, 0508 Oslo
Österreich	+43 18 66 400	Herziggasse 9, 1230 Wien
Polska	+48 22 43 47 300	ul. Kolejowa 5/7, Warsaw
Portugal	+35 12 14 40 39 39	Quinta da Fonte - Edifício Gonçalves Zarco - Q 35 - 2774 - 518 Paço de Arcos
Romania	+40 21 451 20 30	Str. Garii Progresului 2, S4, 040671 RO
Schweiz/Suisse/Svizzera	+41 62 88 99 111	Industriestrasse 10, CH-5506 Mägenwil
Slovenija	+38 61 24 25 731	Electrolux Ljubljana, d.o.o. Tržaška 132, 1000 Ljubljana
Slovensko	+421 2 43 33 43 22	Electrolux Slovakia s.r.o., Electrolux Domáce spotrebiče SK, Seberínho 1, 821 03 Bratislava Konepajanranta 4, 28100 Pori
Suomi	+35 8 26 22 33 00	
Sverige	+46 (0)771 76 76 76	Electrolux Service, S:t Göransgatan 143, S-105 45 Stockholm
Türkiye	+90 21 22 93 10 25	Tarlabası caddesi no : 35 Taksim Istanbul
Россия	+7 495 9377837	129090 Москва, Олимпийский проспект, 16 БЦ „Олимпик”

# TRICITY BENDIX

[www.electrolux.com](http://www.electrolux.com)

[www.tricity-bendix.co.uk](http://www.tricity-bendix.co.uk)

## Free Manuals Download Website

<http://myh66.com>

<http://usermanuals.us>

<http://www.somanuals.com>

<http://www.4manuals.cc>

<http://www.manual-lib.com>

<http://www.404manual.com>

<http://www.luxmanual.com>

<http://aubethermostatmanual.com>

Golf course search by state

<http://golfingnear.com>

Email search by domain

<http://emailbydomain.com>

Auto manuals search

<http://auto.somanuals.com>

TV manuals search

<http://tv.somanuals.com>