

TRICITY BENDIX

*OPERATING & INSTALLATION
INSTRUCTIONS*

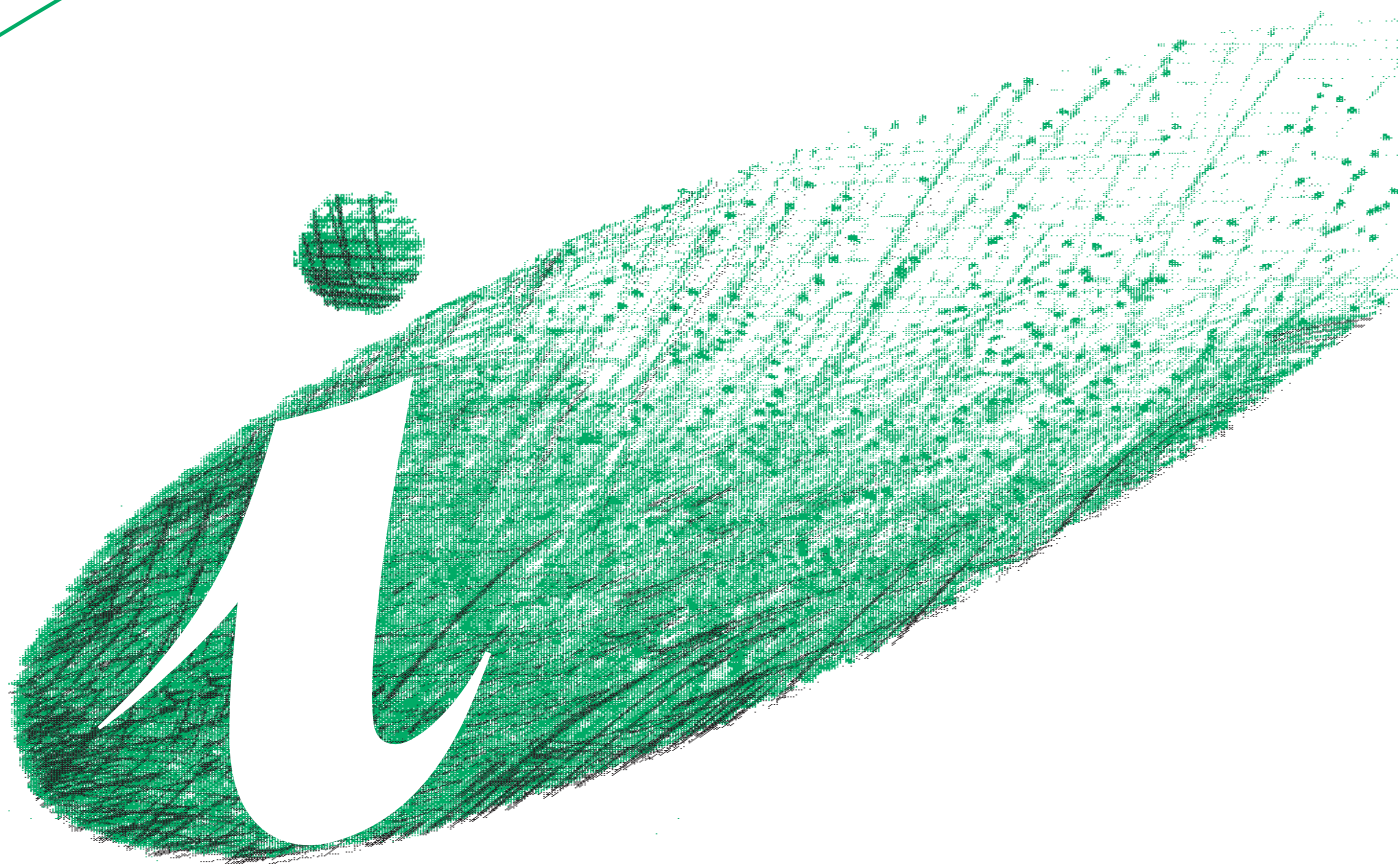

SPLASHBACK ELECTRIC COOKER

SB412

PLEASE READ THIS INSTRUCTION BOOKLET BEFORE USING THE APPLIANCE

TECHNICAL DETAILS

MODEL NO. SB412

Voltage:	230-240 Volts AC 50Hz
Wattage:	9.8-10.7kW
Height:	1290mm
Width:	550mm
Depth:	595mm
Weight:	55 kg

 This appliance complies with: European Council Directive 73/23/EEC.
EMC Directive 89/336/EEC.
CE Marking Directive 93/68/EEC

CONTENTS

Technical Details	2
Contents	3
Preface	4
Safety	5
Before Installation	5
During Operation	5
After Use	6
General	6
Introduction	7
Rating Plate	7
Installation	7
General Notes on Using Your Appliance	8
About Condensation and Steam	8
Grill and Oven Furniture	8
Control Panel Indicator Neon	8
Getting to Know Your Appliance	9
The Control Panel	9
The Radiant Hob	10
Recommended Saucepans	10
Hints and Tips	10
Deep Fat Frying	11
Preserving	11
The Grill	12
The Grill Pan and Handle	12
Hints and Tips	12
Grilling Chart	13
The Oven	14
To Fit the Oven Shelves	14
Hints and Tips	14
Oven Cooking Chart	15
Oven Roasting Chart	16
Care and Cleaning	17
Cleaning Materials	17
Cleaning the Outside of the Appliance	17
Cleaning the Hob and Hotplate Trims	17
Cleaning the Grill and Oven Furniture	17
Cleaning Inside the Grill and Oven Compartments	18
Something Not Working?	19
Service and Spare Parts	20
Guarantee Conditions	21
Notes	22

PREFACE

Dear Customer,

Thank you for buying a Tricity Bendix appliance. With our 80 years experience in developing and manufacturing the very best in U.K. appliances, you can be assured that you have purchased a hard working, reliable, quality product.

Tricity Bendix appliances comply with British Standard safety and performance requirements. They have been approved by BEAB (British Electrotechnical Approvals Board) and are covered by a 12 month parts and labour guarantee.

To get the best from your new Tricity Bendix appliance, we ask that you PLEASE READ THESE INSTRUCTIONS CAREFULLY. Particular attention should be made to cooking times and temperatures, which may differ, from your previous appliance.

It is most important that this instruction book is retained with the appliance for future reference. Should the appliance be sold, or if you move house and leave the appliance, always ensure that the book remains with the appliance. This will enable the new owner to be acquainted with the functioning of the appliance and the relevant warnings.

Please read the whole instruction book before attempting to use the appliance ensuring you follow the recommendations given.

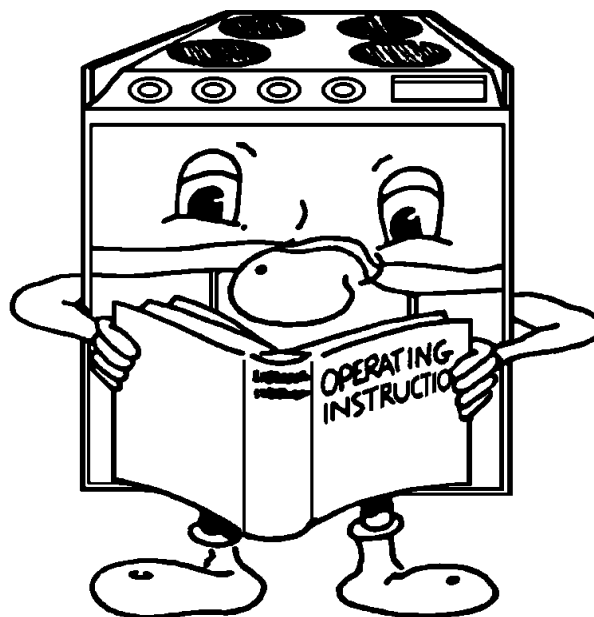

SAFETY

THESE WARNINGS ARE PROVIDED IN THE INTERESTS OF YOUR SAFETY. ENSURE THAT YOU UNDERSTAND THEM ALL BEFORE INSTALLING OR USING THE APPLIANCE.

PLEASE
READ
CAREFULLY



BEFORE INSTALLATION



This appliance is heavy and care **must** be taken when moving it.

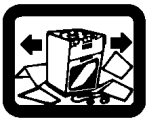

Ensure that all packaging, both inside and outside the appliance has been removed before the appliance is used.

If the appliance is to be placed on a base, measures must be taken to prevent the appliance slipping from the base.



Do not try to *lift* or move the appliance by pulling the door handles.

The electrical installation work **must** be undertaken by a qualified electrician/competent person.



It is dangerous to alter or modify the specifications of the appliance in any way.



Do not allow young children to play with any part of the packaging.



After installation, please dispose of the packaging with due regard to safety and the environment, your local authority can arrange this.

DURING OPERATION

This appliance is not intended to be operated by means of an external timer or remote control system.



Do not use this appliance if it is in contact with water. **Never** operate it with wet hands.



This appliance is designed to be operated by adults. Young children **must not** be allowed to tamper with the appliance or play with the controls.

During use the appliance becomes **Hot**. Care should be taken to avoid touching the heating elements inside the oven.

CAUTION: Accessible parts may be hot when the grill is in use. Young children should be kept away.



Take **great care** when heating fats and oils, as they will ignite if they become too **hot**.

This appliance has been designed for cooking edible foodstuffs only, and **must not** be used for any other purposes.



Never place plastic or any other material which may melt in the oven or on the hob.



Ensure cooking utensils are large enough to contain foods to prevent spillages and boil overs.

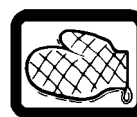

The handles of saucepans which are smaller than the heated area on the hob will become hot. **Ensure** your hand is protected before handling the pan.



Take care to follow the recommendations given for tending the food when grilling.

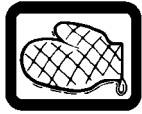

Always use oven gloves to remove and replace food in the oven.

Ensure that all vents are left unobstructed to ensure ventilation of the oven cavity.

Ensure the anti-tilt shelves are put in place correctly. Refer to instructions on page 14.



Never line any part of the appliance with foil. **Do not** allow heatproof cooking materials e.g. roasting bags, to come into contact with oven elements.



Always stand back from the appliance when opening the oven door to allow any build up of steam or heat to release.



Never leave the appliance unattended when the door is open.



Do not place sealed cans or aerosols inside the oven. They may explode if they are heated.

AFTER USE



Ensure that all control knobs are in the OFF position when not in use.



For hygiene and safety reasons this appliance should be kept clean at all times. A build-up of fats or other foodstuffs could result in a fire, especially in the grill pan.



Do not leave utensils containing foodstuffs, e.g. fat or oil in or on the appliance in case it is inadvertently switched ON.



Appliances and hobs become **very hot**, and retain their heat for a long period of time after use. Children should be kept well away from the appliance until it has cooled.

GENERAL



Under no circumstances should any repairs be carried out by an inexperienced person as this may cause injury or serious malfunction.

This appliance should be serviced by an authorised service Engineer and only genuine-approved spare parts should be used.



Do not stand on the appliance or on the open oven door.



Do not hang towels, dishcloths or clothes from the appliance or its handle. They are a safety hazard.

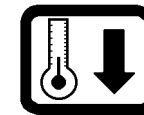

Always switch OFF the appliance at its power point and allow the appliance to cool before any maintenance or cleaning work is carried out.



Only clean this appliance in accordance with the instructions given in this book.

Your safety is of paramount importance.

Therefore, if you are unsure about any of the meanings of these WARNINGS contact the:

**Customer Care Department
Telephone 0870 5 950950**

INTRODUCTION

WARNING: THIS APPLIANCE MUST BE EARTHED

RATING PLATE

This is situated on the lower front frame of the appliance and can be seen upon opening the door. Alternatively the rating plate may also be found on the back or top of some models (where applicable).

The appliance must be protected by a suitably rated fuse or circuit breaker. The rating of the appliance is given on the rating plate.

Do not remove the rating plate from the appliance as this may invalidate the guarantee.

INSTALLATION

If your appliance has been damaged in transit, contact your supplier immediately. **DO NOT** attempt to install it.

Your appliance left the factory fully packaged to protect it from damage. If it is delivered without packaging and damage has occurred, the manufacturer cannot accept responsibility. Contact your supplier for advice.

Once the packaging has been removed the appliance should only be moved by hand. **DO NOT** use a sack barrow or any other aid to lift the appliance as damage may occur.

Connection to the electricity supply must be carried out by a qualified electrician/competent person.

The electrical connection should be made using a double pole isolating switch (cooker socket) with at least 3mm contact separation in all poles. The cable must have conductors of sufficiently high cross-sectional area to prevent overheating and deterioration.

The recommended cross-section area is six square millimetres (6.00mm²).

SB 412WTS

The electrical connection must be made using an all pole isolating switch, or other suitable means of disconnection, with at least 3mm contact separation. The cable must have conductors of sufficiently high cross-sectional area to prevent overheating and comply with all relevant wiring regulations.

The cable should be routed away from potentially hot areas marked by 'X' in the diagram below.

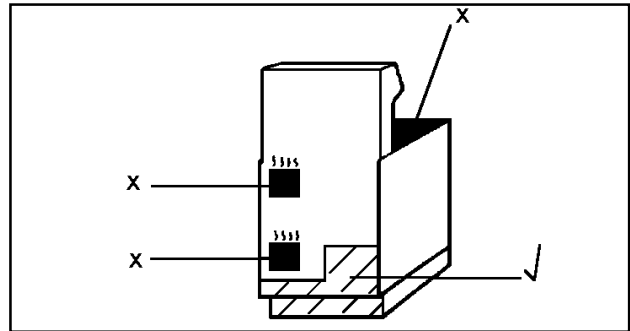

To move the appliance, open the main oven door, and lift the appliance by holding inside the top of the oven compartment.

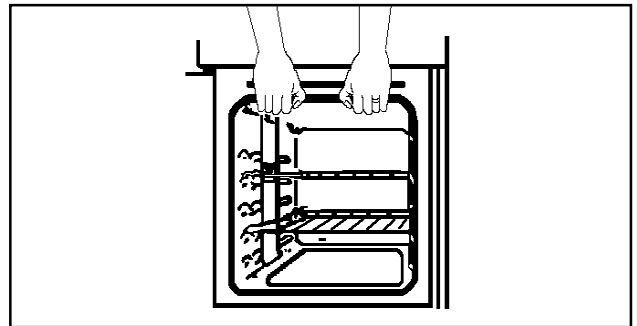

This is a type 'Y' appliance, which means it is free-standing and can be fitted with cabinets on one or both sides.

Side walls which are above hob level should be protected by heat resistant non-combustible material and **MUST NOT** be nearer than 40mm to the hob side.

A nominal air gap of 2mm at either side of the appliance is required to enable the appliance to be moved into position.

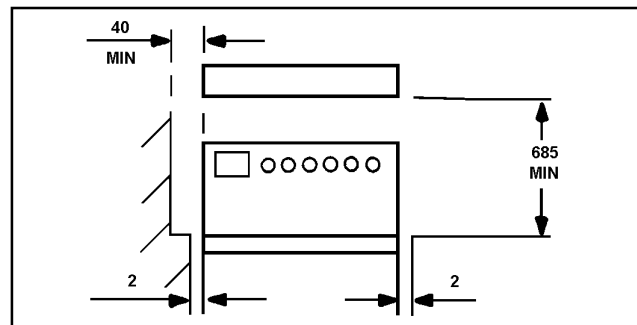

Overhanging surfaces or a cooker hood should be a minimum of 685mm above the hob.

It is important to ensure that the appliance is level after installation. Levelling feet are fitted to the appliance to accommodate uneven floors.

GENERAL NOTES ON USING YOUR APPLIANCE

We suggest that you run the oven elements for 10 – 15 minutes at 220°C to burn off any residue from their surfaces. The procedure should be repeated with the grill for approximately 5 – 10 minutes. During this period an odour may be emitted, it is therefore advisable to open a window for ventilation.

ABOUT CONDENSATION AND STEAM

When food is heated it produces steam similar to a boiling kettle. The oven is vented to allow some of this steam to escape between the wall and the rear of the appliance. However, always stand back from the appliance when opening the oven door to allow any build up of steam or heat to release.

If the steam comes into contact with a cool surface on the outside of the appliance, e.g. a trim, it will condense and produce water droplets. This is quite normal and is not caused by a fault on the appliance.

To prevent discolouration, regularly wipe away condensation and also soilage from surfaces.

For your safety wall coverings at the rear of the appliance should be securely fixed to the wall.

CONTROL PANEL INDICATOR NEON

The light will indicate whether the oven is switched on, the neon also indicates when the set temperature has been reached. The neon will turn on and off during use to show that the temperature is being maintained.

GRILL AND OVEN FURNITURE

The following items of grill/oven furniture have been supplied with the appliance. If you require replacements of any of the items listed below, please contact your local Service Force Centre quoting the relevant part number.

1 grill pan
(311409401)

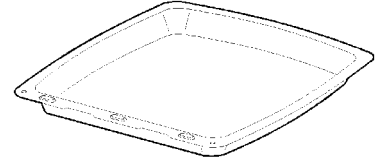

1 grill pan handle
(311468100)

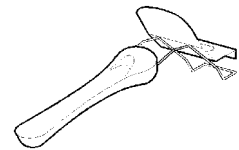

Note:

If you require an additional handle for your grill pan, this can be ordered from your local Service Force Centre by quoting part number 311479800\6.

1 grill pan grid
(311419801)

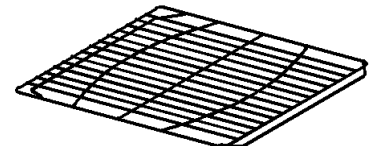

1 straight shelf
for grilling

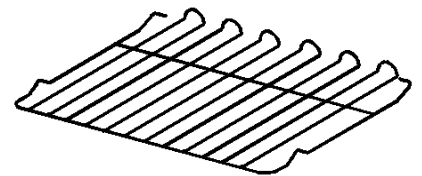

2 straight shelves
for oven cooking

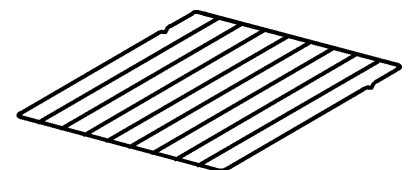

GETTING TO KNOW YOUR APPLIANCE

THE CONTROL PANEL

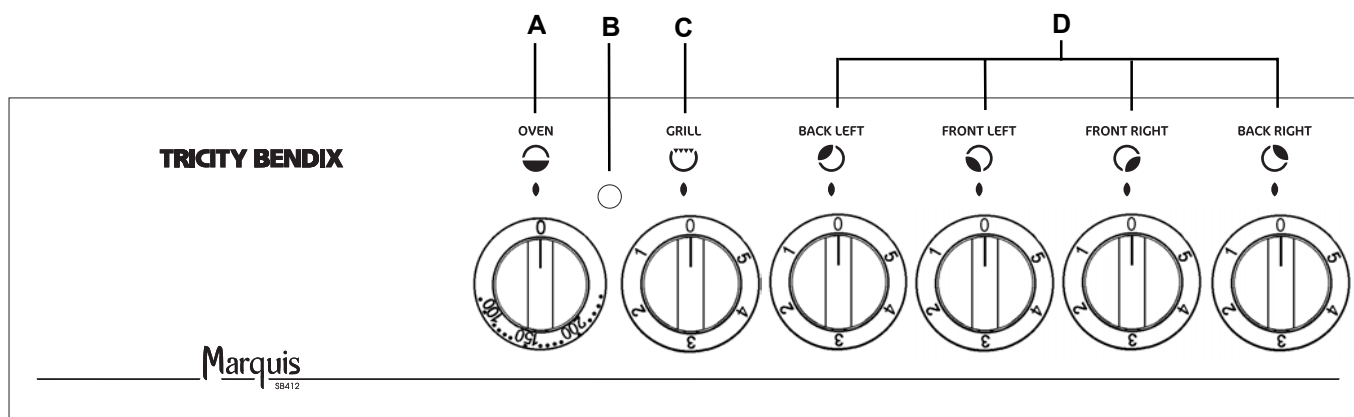

FEATURES

- A - Oven Temperature Control
- B - Oven Indicator Neon
- C - Grill Control
- D - Hotplate Controls

THE RADIANT HOB

USING THE HOB

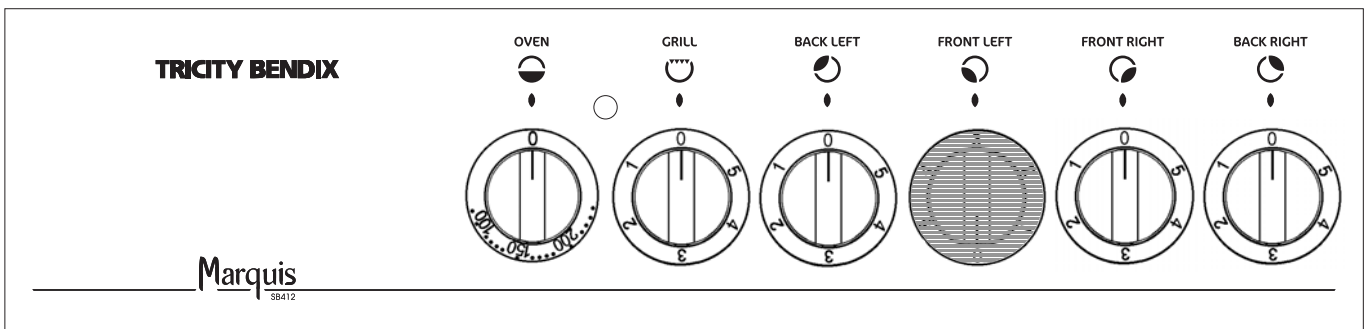

- To operate the hotplates, turn the control knobs clockwise from the OFF position to the required setting.
- The highest number represents the hottest setting and the lowest number represents the coolest setting. Choose a setting appropriate to the quantity and type of food to be cooked.

RECOMMENDED SAUCEPANS

For speed and economy only good quality saucepans with flat bases and close fitting lids are recommended.

The saucepan base should cover the hotplate as much as possible. A base diameter of up to 225mm (9") may be used on a 180mm (7") hotplate.

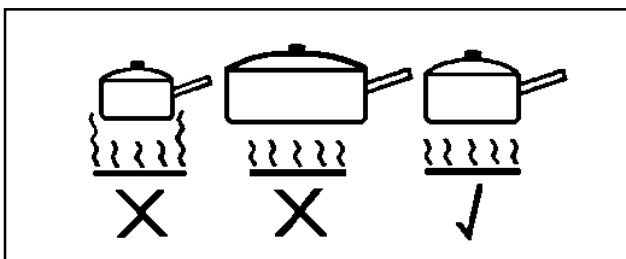

Pressure cookers, preserving pans etc., should comply with the recommendations given above. Traditional round bottomed Woks **must not be** used even with a stand. Woks with flat-bottomed bases are available and do comply with the above recommendations.

HINTS AND TIPS

- Lift, rather than slide saucepans on and off the hob to help reduce scratches and maintain the efficiency of the hotplates.

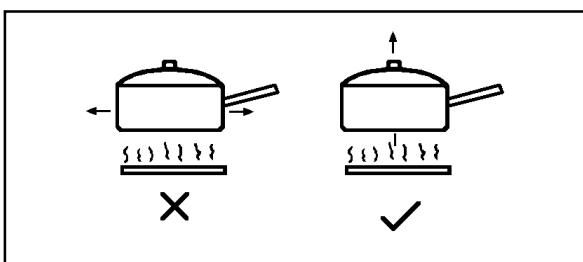

- Avoid placing fish kettles or large preserving pans across two hotplates as this may cause damage.

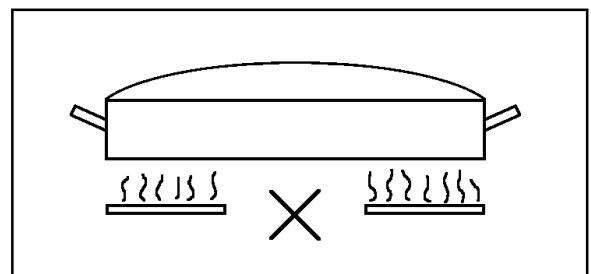

- Follow any guidelines provided by the saucepan manufacturer, particularly those relating to recommended heat settings.
- Avoid using thin, badly dented or distorted saucepans. Those with uneven bases should not be used.

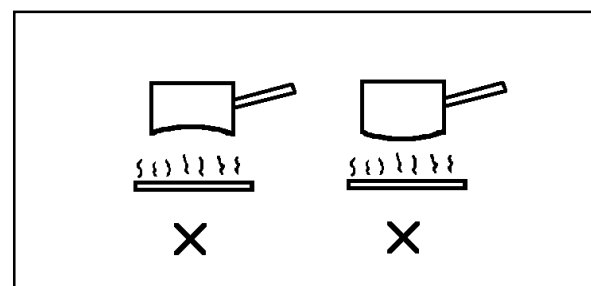

- To prolong the life of the hotplates:
 - Never use utensils with a skirt, e.g. a bucket.
 - Never use an asbestos mat.
 - Never line the spillage tray with foil.
 - Never leave the hotplates ON when not covered with a saucepan.
- For full details on deep fat frying and preserving refer to instructions on page 11.

DEEP FAT FRYING

SPECIAL FRYING NOTE:

For safety purposes when deep fat frying, fill the pan one third full of oil, **DO NOT** cover the pan with a lid and **DO NOT** leave the pan unattended. In the unfortunate event of a fire, switch the appliance OFF at the electricity supply and cover the pan with a lid or damp cloth to assist in smothering the flames.

DO NOT use water on the fire. Leave the pan to cool for at least 30 minutes before moving it.

DO NOT leave the fat or oil in the frying pan on the hob to store it in case the hob is inadvertently switched ON.

1. Preparing the food.

Seal the food by coating with flour, egg and breadcrumbs or batter. **Do not** use a basket with batter coated foods as they will stick.

2. Amount of oil.

For safety purposes fill the pan only one-third full of oil.

3. Testing the temperature of the oil.

It is advisable to use a thermometer to test the temperature of the oil. Alternatively, drop a small cube of bread into the oil which should brown in just under a minute if the oil is at the correct temperature of 190°C/375°F.

4. Cooking the food.

Lower the food gently into the oil. **Do Not** add too much food at once or the temperature of the oil will be reduced and may result in soggy, greasy food.

Turn the food if necessary; doughnuts float to the surface so will not brown on the upperside if not turned. Once cooked, drain the food on absorbent paper.

5. Double frying chips.

Double frying will ensure good chips. First fry the chips for a few minutes at 170°C/340°F to seal the outside. Remove the chips from the oil. Increase the temperature of the oil to 190°C/375°F to finish cooking and brown the chips.

Chips may be kept for several hours after the first frying before finishing off with the second frying.

6. Frying temperatures

	Celsius Scale (°C)	Fahrenheit Scale (°F)
	150	300
First frying of potatoes	170 175 180	340 350 360
Second frying of potatoes	190	375
Frying chicken and fish	195 200	380 390

PRESERVING

1. **DO NOT** use a pan that overlaps the perimeter of the hob trim.

2. To allow for a full rolling boil, the pan should be no more than one third full when all the ingredients have been added. It is better to use two pans rather than overfill one, or use half quantities.

3. Use firm fruit or vegetables and wash well before using.

4. Preserving sugar gives clear jam, however granulated sugar is cheaper and gives equally good flavour.

5. Crystallization may be caused if sugar is not completely dissolved before bringing jam to the boil. Over boiling will affect the flavour, setting properties and colour of the jam.

6. To test jam for setting:

If a jam thermometer is available, boil jam to 104°C. Marmalade should be boiled to 106°C.

If a jam thermometer is not available, remove pan from heat, place sample of jam on a cold dish and cool quickly (i.e. in a freezer or frozen food storage compartment of a refrigerator). When cold, it will crinkle and hold the mark of a finger run through it, if it is at setting point.

7. The scum should be removed as soon as possible after setting point has been reached. Marmalade should be allowed to cool before potting to prevent the peel rising.

THE GRILL

CAUTION – ACCESSIBLE PARTS MAY BECOME HOT WHEN THE GRILL IS IN USE. CHILDREN SHOULD BE KEPT AWAY.

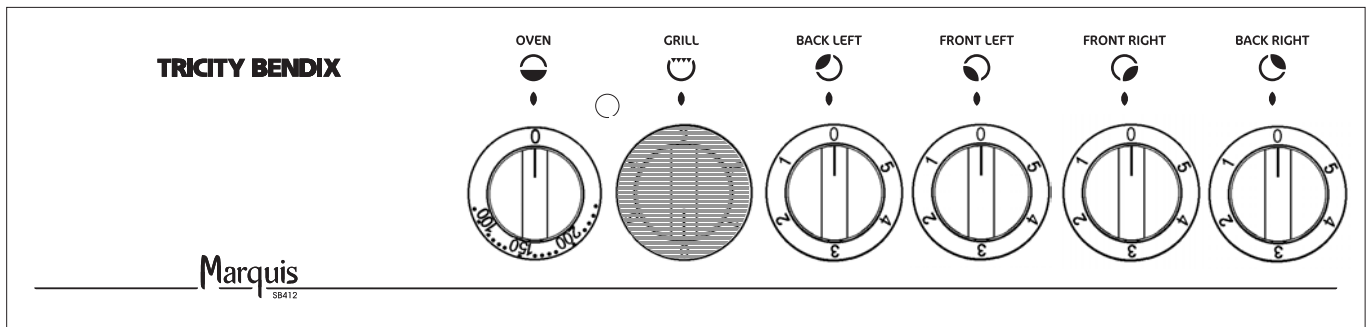

- To operate the grill, turn the control in either direction to the required setting.
- The highest number represents the hottest setting and the lowest number represents the coolest setting.

NOTE:

THE GRILL DOOR MUST BE LEFT OPEN DURING GRILLING.

THE GRILL PAN AND HANDLE

The grill pan is supplied with a removable handle.

To attach the handle, place the wirework under the cut out top so that the metal plate hooks over the top of the grill pan.

Slide the handle to the left and over the central bump on the grill pan.

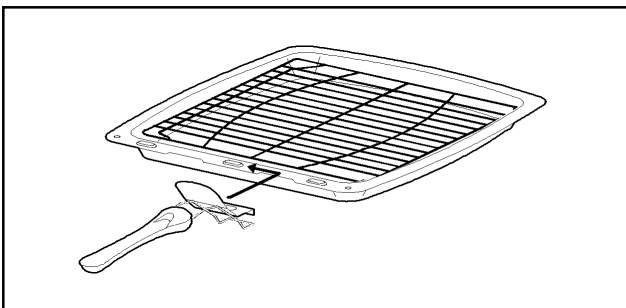

Ensure the handle is correctly located. It is not necessary to remove the grill pan handle during grilling.

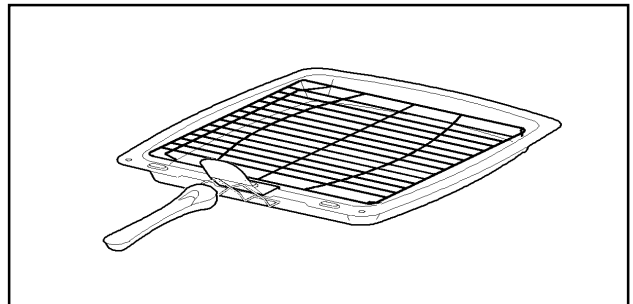

To remove the handle, slide the handle to the right and lift the handle away from the cut out on the grill pan.

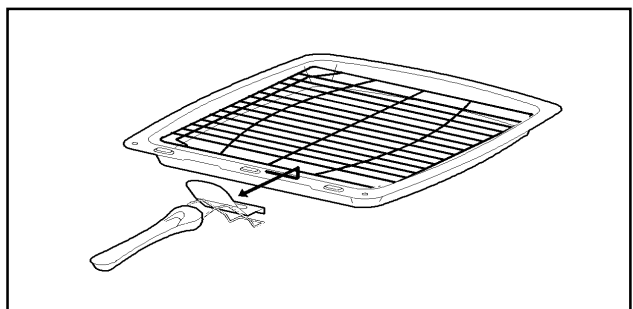

Place the grill pan on the shelf so that the pan is positioned centrally beneath the grill.

To check the progress of the food being grilled, the grill pan should be withdrawn on the shelf to attend to food during cooking.

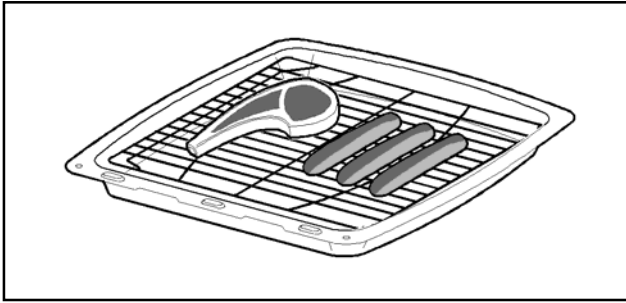

HINTS AND TIPS

- Food should be thoroughly dried before grilling to minimise splashing. Brush lean meats and fish lightly with a little oil or melted butter to keep them moist during cooking.
- Adjust the height of the grilling grid and grill pan runner position to allow for different thicknesses of foods.
- Accompaniments such as tomatoes and mushrooms may be placed underneath the grid when grilling meats.

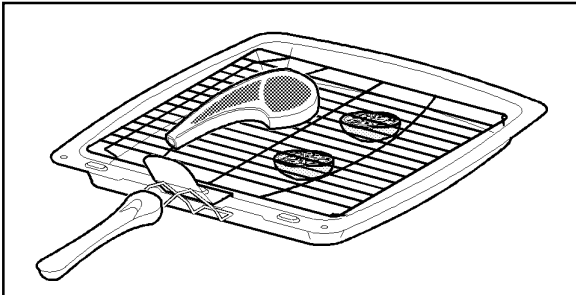

- When toasting bread use the straight shelf in position 1 with the grid in the high position.
- Preheat the grill on a full setting for a few minutes before cooking. Adjust the heat setting and the shelf as necessary during cooking.
- The food should be turned over during cooking as required.

NOTE:

If you require an additional handle for your grill pan, this can be ordered from your local Service Force Centre by quoting part number 3111479800\6.

GRILLING CHART

FOOD	SHELF	GRILL TIME (mins in total)
Bacon Rashers	Adjust	5 - 6
Beefburgers	shelf	10 - 15
Chicken Joints	position	30 - 40
Chops – Lamb Pork	and	15 - 20 20 - 30
Fish Whole Trout/Mackerel	grill pan	15 - 25
Fillets – Plaice/Cod	grid	10 - 15
Kebabs	to	20 - 30
Kidneys – Lamb/Pig	suit	8 - 12
Liver Lamb/Pig	different	10 - 20
Sausages	thicknesses	20 - 30
Steaks – Rare Medium Well Done	of food	6 - 12 12 - 16 14 - 20
Toasted sandwiches		3 - 4

Shelf positions are counted from the bottom upwards.

The times quoted above are given as a guide and should be adjusted to suit personal taste.

THE OVEN

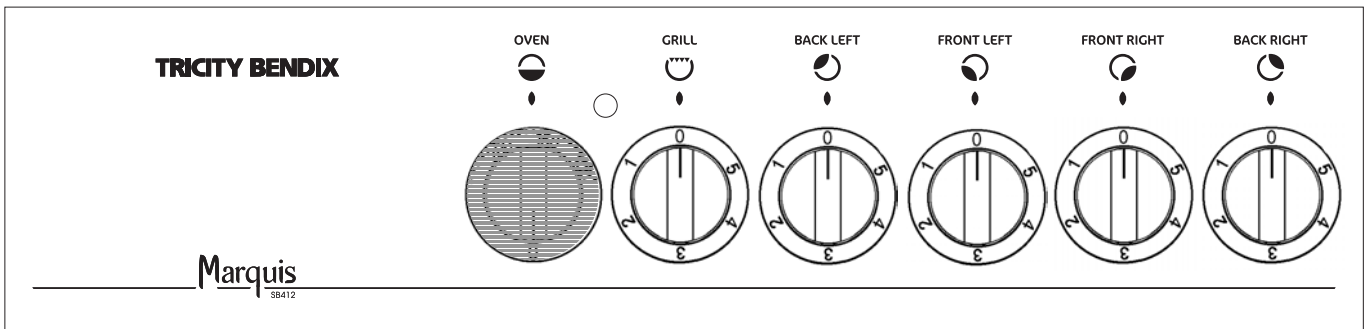

- To operate the oven turn the oven control to the required temperature.

THINGS TO NOTE

The oven indicator neon will glow until the oven has reached the required temperature and then go out. It will turn ON and OFF periodically during cooking showing that the temperature is being maintained.

TO FIT THE OVEN SHELVES

The shelves should be fitted with the straight rods uppermost on the frame and the forms towards the back of the oven. If not fitted correctly the anti-tilt and safety stop mechanism will be affected.

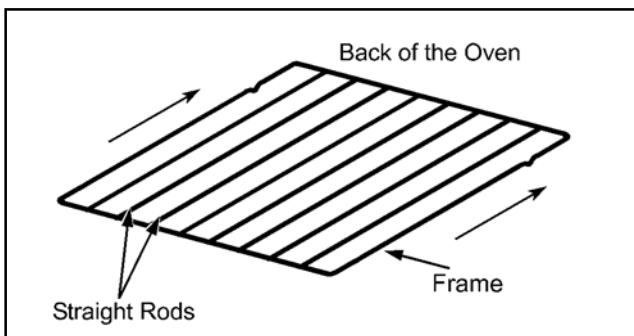

HINTS AND TIPS

- Arrange the shelves in the required positions before switching the oven ON. Shelf positions are numbered from the bottom upwards.
- The oven is fitted with side elements. The top of the oven is the hottest part of the oven and the bottom the coolest.
- Avoid placing food too close to the side element oven linings to prevent scorching.

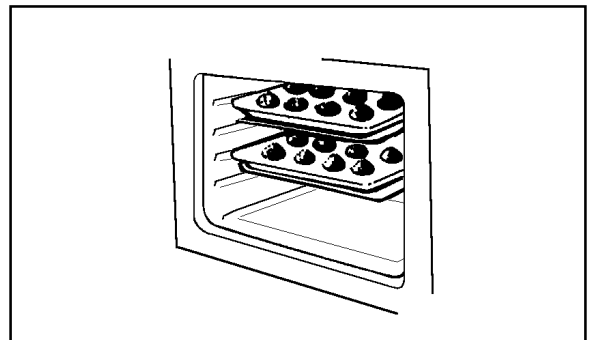

- **Do not** line any part of the oven with foil as it may cause damage or interfere with the air circulation.

For best results always:-

- Preheat the oven until the indicator neon goes out.
- For economy leave the door open for the shortest possible time particularly when placing food into a pre-heated oven.

OVEN COOKING CHART

The oven temperatures are intended as a guide only. It may be necessary to increase or decrease the temperatures by 10°C to suit individual preferences and requirements.

FOOD	OVEN SHELF POSITIONS	COOKING TEMP (°C)	APPROXIMATE COOK (TIME MINS)
Biscuits	4 and 5	190 - 200	10 - 20
Flapjacks	5	180 - 190	25 - 30
Shortbread	3	150 - 160	45 - 65
Bread			
Bread rolls/buns	1 and 5	210 - 220	20 - 30
Casseroles- Beef	3	140 - 150	2 - 3 hours
Chicken	3	180 - 190	1½ hours
Cakes: Small & Queen	2 and 5	180 - 190	20 - 25
Victoria sandwich	2 and 5	180 - 190	20 - 25
Gingerbread	3	150 - 160	1¼ - 1½ hours
Madeira	3	170 - 180	1 - 1¼ hours
Rich fruit	3	150 - 160	2¼ - 2¾ hours
Christmas	2	140 - 150	Depending on size 3 - 4½ h
Meringues	2	90 - 100	2½ - 3 hours
Convenience foods		Follow instructions on the pack	
Fish	3	180 - 190	20 - 30
Fish pie (potato topped)	3	200 - 210	20 - 25
Shepherds pie	4	210 - 220	40 - 45
Fruit pies and crumbles	4	210 - 220	40 - 45
Milk puddings	2	150 - 160	1½ - 2 hours
Pastry: Choux – Chocolate eclairs	2 and 5	190 - 200	30 - 35
Profiteroles	2 and 5	180 - 190	20 - 30
Shortcrust – Mince pies	2 and 5	200 - 210	15 - 20
Flaky/Puff pies	3	220 - 230	30 - 40
Quiche Lorraine/tarts/flan	5	200 - 210	30 - 45
Meat pie	5	200 - 210	30 - 45
Plate tarts/pies	2 and 5	200 - 210	30 - 45
Scones	2 and 5	230 - 240	8 - 12
Soufflé	3	200	30 - 40
Roasting Meat and Poultry	1	180 - 200	See Roasting Chart
Pasta e.g. Lasagne	3	200	30 - 40
Vegetable dishes			
Baked jacket potatoes	2 and 4	200	1 - 1½ hours
Roast potatoes	5	200 - 220	1 - 1½ hours
Yorkshire puddings: Large	5	230	35 - 40
Individual	2 and 5	230	35 - 40

Note: Shelf positions are counted from the bottom of the oven.

ROASTING CHART

MEAT	TEMPERATURES (°C)	COOKING TIME
	OVEN	
Beef	180 - 200°C	20-35 minutes per ½kg (1lb) and 20-35 minutes over
Beef, boned	180 - 200°C	25-35 minutes per ½kg (1lb) and 25-35 minutes over
Mutton and Lamb	180 - 200°C	25-35 minutes per ½kg (1lb) and 25-35 minutes over
Pork and Veal	180 - 200°C	30-40 minutes per ½kg (1lb) and 30-40 minutes over
Ham	180 - 200°C	30-40 minutes per ½kg (1lb) and 30-40 minutes over
Chicken	180 - 200°C	15-20 minutes per ½kg (1lb) and 20 minutes over
Turkey and Goose	180 - 200°C	15-20 minutes per ½kg (1lb) up to 3½kg (7lb) then 10 minutes per ½kg (1lb) over 3½kg (7lb)
Duck	180 - 200°C	25-35 minutes per ½kg (1lb) and 25-35 minutes over
Pheasant	180 - 200°C	35-40 minutes per ½kg (1lb) and 35-40 minutes over
Rabbit	180 - 200°C	20 minutes per ½kg (1lb) and 20 minutes over
Potatoes with meat	180 - 200°C	According to size
Potatoes without meat	190 - 200°C	According to size

The roasting temperatures and times given in the chart should be adequate for most joints, but slight adjustments may be required to allow for personal requirements and the shape and texture of the meat. However, lower temperatures and longer cooking times are recommended for less tender cuts or larger joints.

Wrap joints in foil if preferred, for extra browning uncover for the last 20 – 30 min. cooking time.

CARE AND CLEANING

ALWAYS SWITCH OFF THE ELECTRICITY SUPPLY AT THE MAIN WALL SWITCH AND ALLOW THE APPLIANCE TO COOL BEFORE CLEANING.

CLEANING MATERIALS

Before using any cleaning materials on your appliance, check that they are suitable and that their use is recommended by the manufacturer.

Cleaners that contain bleach should NOT be used as they may dull the surface finishes. Harsh abrasives should also be avoided.

CLEANING THE OUTSIDE OF THE APPLIANCE

DO NOT use abrasive cleaning materials, or scourers on the outside of the appliance as some of the finishes are painted and damage may occur. Regularly wipe over the control panel, doors and appliance sides using a soft cloth and liquid detergent.

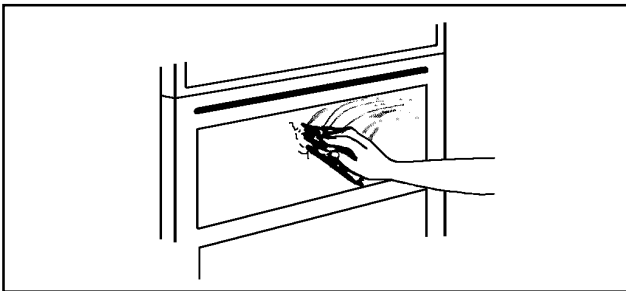

DO NOT ATTEMPT TO REMOVE ANY OF THE CONTROL KNOBS FROM THE APPLIANCE AS THIS MAY CAUSE DAMAGE AND IS A SAFETY HAZARD.

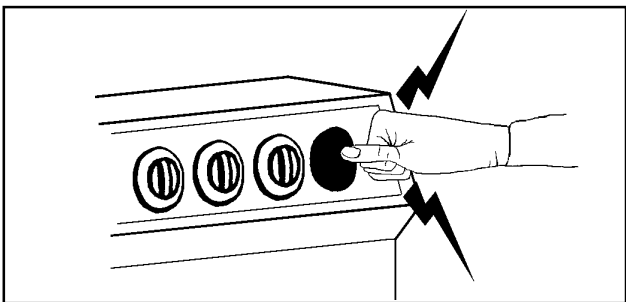

CLEANING THE HOB AND HOTPLATE TRIMS

Clean the hob surface with liquid detergent or a mild abrasive cleaner.

The chrome hotplate trims are removable for cleaning, and can be washed in the dishwasher. The chrome hotplate supports should NOT be removed.

The spillage tray below the hotplates can be cleaned using a soap impregnated steel wool pad.

For convenience, the hob is hinged and can be supported using the stay rod during cleaning.

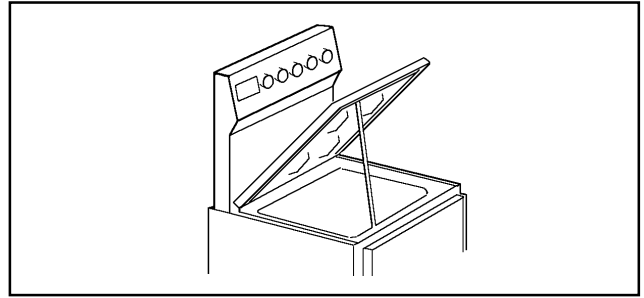

CLEANING THE GRILL AND OVEN FURNITURE

All removable parts, except the grill pan handle can be washed in the dishwasher.

The grill pan, grill pan grid and oven shelves may be cleaned using a soap impregnated steel wool pad. Soaking first in hot soapy water will make cleaning easier.

CLEANING INSIDE THE OVEN AND GRILL COMPARTMENTS

The vitreous enamel in the grill compartment and on the oven base can be cleaned using normal oven cleaners or aerosol oven cleaners with care.

Ensure that the manufacturers instructions are followed and that all parts are well rinsed afterwards.

Aerosol cleaners must not be used on Stayclean surfaces and must not come into contact with elements as this may cause damage.

CARE OF STAYCLEAN SURFACES

Your appliance has oven linings coated with a special finish to help make cleaning the oven easier.

The Stayclean surfaces destroy splashes of food and fats when the oven temperature is raised to around 220°C.

It is a good idea to run the oven for an hour or two per week to ensure continued good performance from the Stayclean finish.

THINGS TO NOTE

When operating the appliance at higher temperatures than used in normal cooking the surfaces of the appliance may get hotter than usual. Children should be kept away.

HINTS AND TIPS

- Manual cleaning of the Stayclean surfaces IS NOT recommended. Damage will occur if abrasives or aerosol sprays of any kind are used.
- Slight discolouration and polishing of the Stayclean surfaces may occur in time. This **DOES NOT** affect the Stayclean properties in any way.
- A good time to allow the oven to run on is after the weekly roast. After removing the roast, turn the oven up to 220°C and allow to run for an hour or so. It is important not to allow a build-up of soilage as this can prevent the Stayclean surfaces from working.
- Follow the recommendations below to keep oven soilage to a minimum.
- Cook at the recommended temperatures. Higher temperatures during roasting will increase soilage. Try cooking at lower temperatures for an increased length of time, you will save energy and often the joint is more tender.
- Use minimal, if any, extra oil or fat when roasting meat, potatoes only require brushing with fat before cooking. Extra fat in the oven during roasting will increase splashing and soilage.
- It is **not** necessary to add water to a meat tin when roasting. The water and the fat juices from the joint create excessive splattering during cooking, even at normal temperatures, as well as causing condensation.
- Covering joints during cooking will also prevent splashing onto the interior surfaces. Removing the covering for the last 20-30 minutes will allow extra browning if required. Some large joints and turkeys especially benefit by this method of cooking, allowing the joint to cook through before the outside is over-browned.

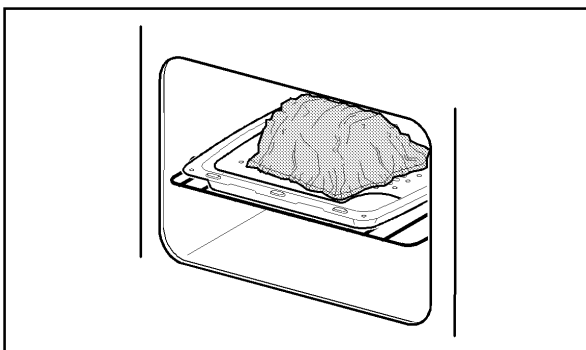

SOMETHING NOT WORKING?

We strongly recommend that you carry out the following checks on your appliance before calling a Service Engineer. It may be that the problem is a simple one which you can solve yourself without the expense of a Service call.

If our Service Engineer finds that the problem is listed below you will be charged for the call whether or not the appliance is under guarantee.

The appliance does not work at all:

- * Check that the appliance has been wired in and is switched on at the wall.
- * Check that the main appliance fuse is working.

The oven temperature is too high or too low:

- * Check that the recommended temperatures are being used (see page 15). Be prepared to adjust the temperature up or down by 10°C to achieve the results you want.

The hotplates are slow to boil or simmer inadequately:

- * Check that the saucepans being used are suitable. See page 10.

The oven is not cooking evenly or the side opening door will not stay open:

- * Check that the appliance is level.

SERVICE AND SPARE PARTS

In the event of your appliance requiring service, or if you wish to purchase spare parts, please contact your local Service Force Centre by telephoning:-

0870 5 929929

Your telephone call will be automatically routed to the Service Force Centre covering your post code area.

For the address of your local Service Force Centre and further information about Service Force, please visit the website at www.serviceforce.co.uk.

Before calling out an engineer, please ensure you have read the details under the heading "Something Not Working?".

When you contact the Service Force Centre you will need to give the following details:

1. Your name, address and post code.
2. Your telephone number.
3. Clear and concise details of the fault.
4. The model and serial number of the appliance (found on the rating plate).
5. The purchase date.

Please note that a valid purchase receipt or guarantee documentation is required for in-guarantee service calls.

For Customer Service in Ireland please contact us at the address below:

Tricity Bendix
Electrolux Group (Irl) Ltd
Long Mile Road
Dublin 12
Republic of Ireland

Tel: +353 (0) 1 4090752

Email: service.eid@electrolux.ie

CUSTOMER CARE DEPARTMENT

For general enquires concerning your Tricity Bendix appliance, or for further information on Tricity Bendix products, please contact our Customer Care Department by letter or telephone at the address below;

Customer Care Department
Tricity Bendix
55 – 77 High Street
Slough
Berkshire
SL1 1DZ
Tel: 0870 5 950950 (*)

*calls to this number may be recorded for training purposes.

GUARANTEE CONDITIONS

Standard guarantee conditions

We, Tricity Bendix, undertake that if within 12 months of the date of the purchase this Tricity Bendix appliance or any part thereof is proved to be defective by reason only of faulty workmanship or materials, we will, at our option repair or replace the same FREE OF CHARGE for labour, materials or carriage on condition that:

- The appliance has been correctly installed and used only on the electricity supply stated on the rating plate.
- The appliance has been used for normal domestic purposes only, and in accordance with the manufacturer's instructions.
- The appliance has not been serviced, maintained, repaired, taken apart or tampered with by any person not authorised by us.
- All service work under this guarantee must be undertaken by a Service Force Centre.
- Any appliance or defective part replaced shall become the Company's property.
- This guarantee is in addition to your statutory and other legal rights.

Home visits are made between **8.30am** and **5.30pm** Monday to Friday. Visits may be available outside these hours in which case a **premium** will be charged.

Exclusions

This guarantee does not cover:

- Damage or calls resulting from transportation, improper use or neglect, the replacement of any light bulbs or removable parts of glass or plastic.
- Costs incurred for calls to put right an appliance which is improperly installed or calls to appliances outside the United Kingdom.
- Appliances found to be in use within a commercial environment, plus those which are subject to rental agreements.
- Products of Tricity Bendix manufacture which are not marketed by Tricity Bendix.

European Guarantee

If you should move to another country within Europe then your guarantee moves with you to your new home subject to the following qualifications:

- The guarantee starts from the date you first purchased your product.
- The guarantee is for the same period and to the same extent for labour and parts as exists in the new country of use for this brand or range of products.
- This guarantee relates to you and cannot be transferred to another user.
- Your new home is within the European Community (EC) or European Free Trade Area.
- The product is installed and used in accordance with our instructions and is only used domestically, i.e. a normal household.
- The product is installed taking into account regulations in your new country.

Before you move please contact your nearest Customer Care centre, listed below, to give them details of your new home. They will then ensure that the local Service Organisation is aware of your move and able to look after you and your appliances.

France	Senlis	+33	(0) 3 44 62 20 13
Germany	Nürnberg	+49	(0) 800 234 7378
Italy	Pordernone	+39	(0) 800117511
Sweden	Stockholm	+46	(0) 20 78 77 50
UK	Slough	+44	(0) 1753 219898
Ireland	Dublin	+353	(0) 1 4090752

NOTES

NOTES

TRICITY BENDIX

Tricity Bendix, 55-77 High Street, Slough, Berkshire SL1 1DZ

Consumer care telephone number 08705 950950

IMPORTANT NOTICE

In line with our continuing policy of research and development, we reserve the right to alter models and specifications without prior notice.

This instruction booklet is accurate at the date of printing, but will be superseded if specifications or appearance are changed.

SB412 - 311666600

© Electrolux plc 2003

 **From the Electrolux Group.** *The world's No.1 choice.*

The Electrolux Group is the world's largest producer of powered appliances for kitchen, cleaning and outdoor use. More than 55 million Electrolux Group products (such as refrigerators, cookers, washing machines, vacuum cleaners, chain saws and lawn mowers) are sold each year to a value of approx. USD 14 billion in more than 150 countries around the world.

Download from www.Somanuals.com. All Manuals Search And Download.

Free Manuals Download Website

<http://myh66.com>

<http://usermanuals.us>

<http://www.somanuals.com>

<http://www.4manuals.cc>

<http://www.manual-lib.com>

<http://www.404manual.com>

<http://www.luxmanual.com>

<http://aubethermostatmanual.com>

Golf course search by state

<http://golfingnear.com>

Email search by domain

<http://emailbydomain.com>

Auto manuals search

<http://auto.somanuals.com>

TV manuals search

<http://tv.somanuals.com>