

TRICITY BENDIX

*OPERATING & INSTALLATION
INSTRUCTIONS*

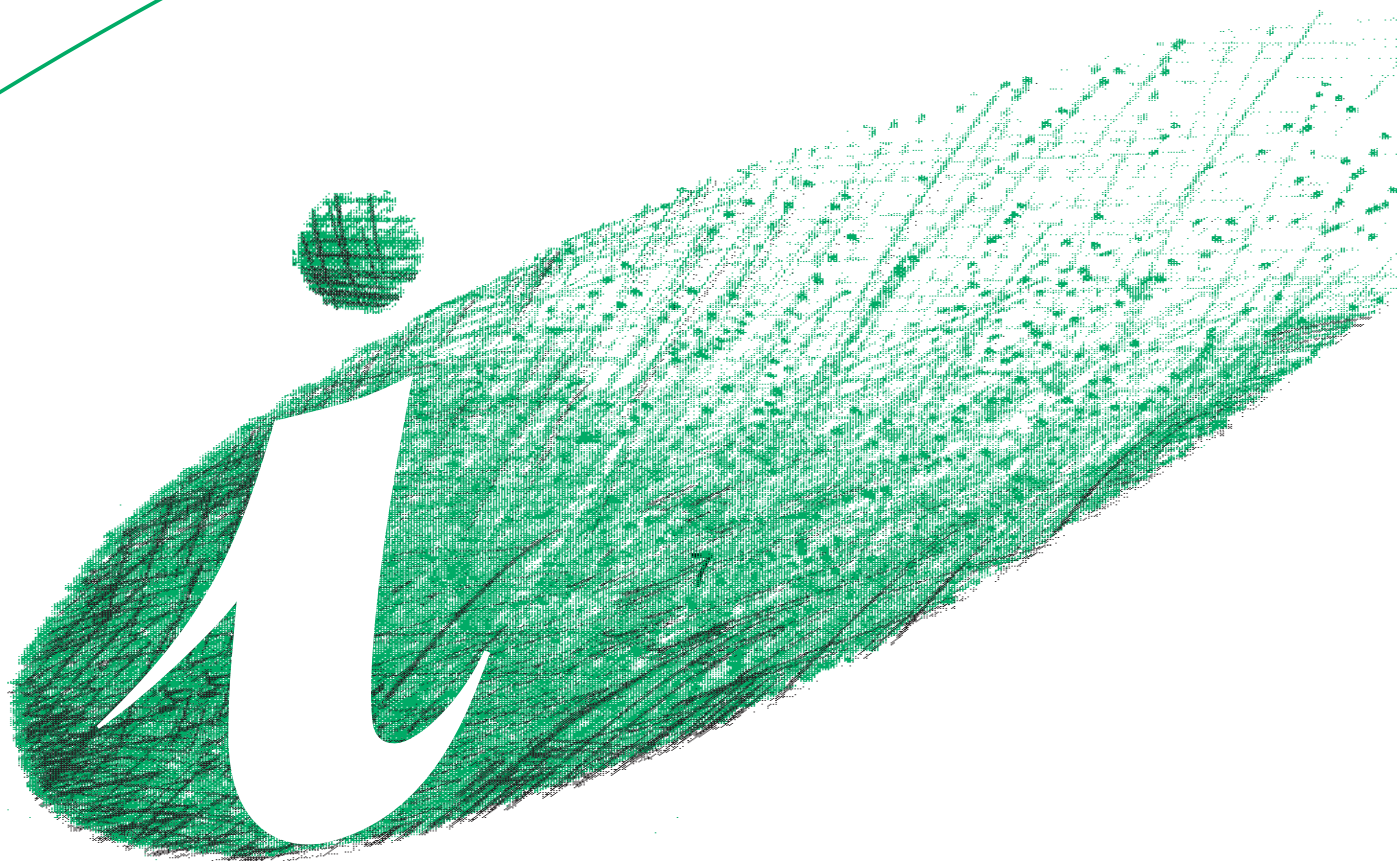

SLIP IN ELECTRIC COOKER

SE305

PLEASE READ THIS INSTRUCTION BOOKLET BEFORE USING THE APPLIANCE

TECHNICAL DETAILS

MODEL NO. SE 305

Voltage:	230-240 Volts AC 50Hz
Wattage:	9.3-10.2kW
Height:	900mm
Width:	500mm
Depth:	600mm
Weight:	50kg

 This appliance complies with: European Council Directive 73/23/EEC.
EMC Directive 89/336/EEC.
CE Marking Directive 93/68/EEC

CONTENTS

Technical Details	2
Contents	3
Preface	5
Safety	6
Before Installation	6
During Operation	6
After Use	7
General	7
Introduction	8
Rating Plate	8
Installation	8
General Notes on Using Your Appliance	9
Oven Indicator Neon	9
About Condensation and Steam	9
Control Panel Indicator Neon	9
Grill and Oven Furniture	9
Getting to Know Your Appliance	10
The Control Panel	10
The Sealed Hotplates	11
Recommended Saucepans	11
Hints and Tips	11
Deep Fat Frying	12
Preserving	12
The Grill	13
Uses of the Grill	13
Selecting the Grill	13
Things to Note	13
The Grill Pan and Handle	13
Hints and Tips	14
Grilling Chart	14
The Fan Oven	15
Uses of the Fan Oven	15
Selecting the Fan Oven	15
Things to Note	15
To Fit the Oven Shelves	15
Hints and Tips	16
Fan Oven Cooking Chart	17
Roasting Chart	18

CONTENTS

Defrost Feature	19
Uses of Defrost Feature	19
Selecting Defrost	19
Things to Note	19
Hints and Tips	19
Care and Cleaning	20
Cleaning Materials	20
Cleaning the Outside of the Appliance	20
Cleaning the Sealed Hotplates and Hotplate Trims	20
Things to Note	20
For Normal Soilage	20
For Heavy Soilage	20
Cleaning the Hotplates Trims	20
Cleaning the Vitreous Enamel	20
After Cleaning	20
Cleaning the Grill and Oven Furniture	21
Cleaning Inside the Oven/Grill Compartments	21
Hints and Tips	21
Something not Working?	22
Service and Spare Parts	23
Guarantee Conditions	24
Notes	25

PREFACE

Dear Customer,

Thank you for buying a Tricity Bendix appliance. With our 80 years experience in developing and manufacturing the very best in U.K. appliances, you can be assured that you have purchased a hard working, reliable, quality product.

Tricity Bendix appliances comply with British Standard safety and performance requirements. They have been approved by BEAB (British Electrotechnical Approvals Board) and are covered by a 12 month parts and labour guarantee.

To get the best from your new Tricity Bendix appliance, we ask that you PLEASE READ THESE INSTRUCTIONS CAREFULLY. Particular attention should be made to cooking times and temperatures, which may differ, from your previous appliance.

It is most important that this instruction book is retained with the appliance for future reference. Should the appliance be sold, or if you move house and leave the appliance, always ensure that the book remains with the appliance. This will enable the new owner to be acquainted with the functioning of the appliance and the relevant warnings.

Please read the whole instruction book before attempting to use the appliance ensuring you follow the recommendations given.

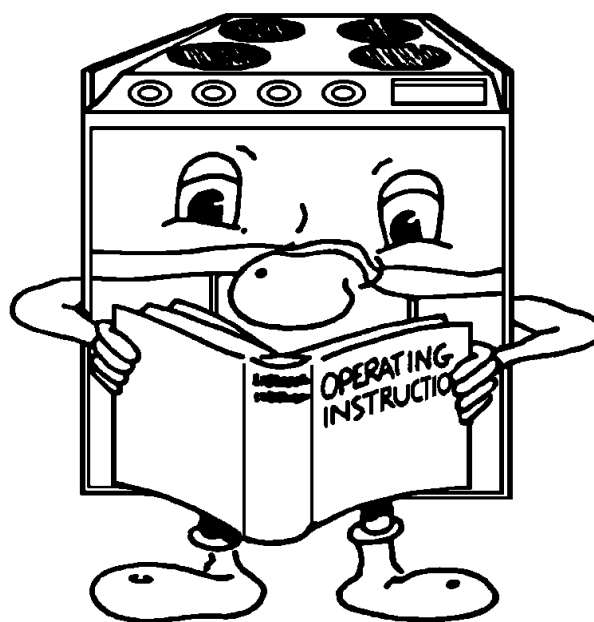

SAFETY

THESE WARNINGS ARE PROVIDED IN THE INTERESTS OF YOUR SAFETY. ENSURE THAT YOU UNDERSTAND THEM ALL BEFORE INSTALLING OR USING THE APPLIANCE.

PLEASE
READ
CAREFULLY



BEFORE INSTALLATION



This appliance is heavy and care **must** be taken when moving it.



Ensure that all packaging, both inside and outside the appliance has been removed before the appliance is used.

If the appliance is to be placed on a base, measures must be taken to prevent the appliance slipping from the base.



Do not try to lift or move the appliance by pulling the door handles.

The electrical installation work **must** be undertaken by a qualified electrician/competent person.



It is dangerous to alter or modify the specifications of the appliance in any way.



Do not allow young children to play with any part of the packaging.



After installation, please dispose of the packaging with due regard to safety and the environment, your local authority can arrange this.

DURING OPERATION

This appliance is not intended to be operated by means of an external timer or separate remote control system.



Do not use this appliance if it is in contact with water. **Never** operate it with wet hands.



This appliance is designed to be operated by adults. Young children **must not** be allowed to tamper with the appliance or play with the controls.

During use the appliance becomes **Hot**. Care should be taken to avoid touching the heating elements inside the oven.

'CAUTION': Accessible parts may be hot when the grill is in use. Young children should be kept away.

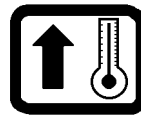

Take **great care** when heating fats and oils, as they will ignite if they become too hot.

This appliance has been designed for cooking edible foodstuffs only, and **must not** be used for any other purposes.



Never place plastic or any other material which may melt in the oven or on the hob.



Ensure cooking utensils are large enough to contain foods to prevent spillages and boil overs.



The handles of saucepans which are smaller than the heated area on the hob will become hot. **Ensure** your hand is protected before handling the pan.



Take care to follow the recommendations given for tending the food when grilling.



Always use oven gloves to remove and replace food in the oven.



Ensure that you support the grill pan when it is in the withdrawn or partially withdrawn position

Ensure that all vents are left unobstructed to ensure ventilation of the oven cavity.

Ensure the anti-tilt shelves are put in place correctly. Refer to instructions on page 15.



Never line any part of the appliance with foil. **Do not** allow heatproof cooking materials e.g. roasting bags, to come into contact with oven elements.



Always stand back from the appliance when opening the oven door to allow any build up of steam or heat to release.



Never leave the appliance unattended when the door is open.



Do not place sealed cans or aerosols inside the oven. They may explode if they are heated.

Do not leave the hotplates switched ON for long periods when not covered by a saucepan. The controls and cabinets may overheat.

AFTER USE



Ensure that all control knobs are in the OFF position when not in use.



For hygiene and safety reasons this appliance should be kept clean at all times. A build-up of fats or other foodstuffs could result in a fire, especially in the grill pan.



Do not leave utensils containing foodstuffs, e.g. fat or oil in or on the appliance in case it is inadvertently switched ON.



Cookers and hobs become **very hot**, and retain their heat for a long period of time after use. Children should be kept well away from the appliance until it has cooled.

GENERAL



Under no circumstances should any repairs be carried out by an inexperienced person as this may cause injury or serious malfunction.

This appliance should be serviced by an authorised service Engineer and only genuine-approved spare parts should be used. Details of repair and servicing arrangements are supplied on page 23 of this book.



Do not stand on the appliance or on the open oven door.



Do not hang towels, dishcloths or clothes from the appliance or its handle. They are a safety hazard.

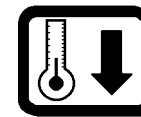

Always switch OFF the appliance at its power point and allow the appliance to cool before any maintenance or cleaning work is carried out.



Only clean this appliance in accordance with the instructions given in this book.

Your safety is of paramount importance.

Therefore, if you are unsure about any of the meanings of these WARNINGS contact the:

**Customer Care Department
Telephone 0870 5 950950**

INTRODUCTION

WARNING: THIS APPLIANCE MUST BE EARTHED

RATING PLATE

This is situated on the front frame of the appliance and can be seen upon opening the door. Alternatively the rating plate may also be found on the back or top of some models (where applicable).

The appliance must be protected by a suitably rated fuse or circuit breaker. The rating of the appliance is given on the rating plate.

Do not remove the rating plate from the appliance as this may invalidate the guarantee.

INSTALLATION

If your appliance has been damaged in transit, contact your supplier immediately. **DO NOT** attempt to install it.

Your appliance left the factory fully packaged to protect it from damage. If it is delivered without packaging and damage has occurred, the manufacturer cannot accept responsibility. Contact your supplier for advice.

Once the packaging has been removed the appliance should only be moved by hand. **DO NOT** use a sack barrow or any other aid to lift the appliance as damage may occur.

Connection to the electricity supply must be carried out by a qualified electrician/competent person.

The electrical connection should be made using a double pole isolating switch (cooker socket) with at least 3mm contact separation in all poles. The cable must have conductors of sufficiently high cross-sectional area to prevent overheating and deterioration.

The recommended cross-section area is six square millimetres (6.00mm²).

The cable should be routed away from potentially hot areas marked by X in the diagram below.

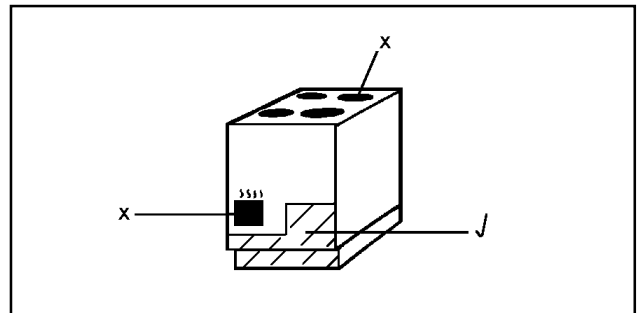

To move the appliance, open the fan oven door, and lift the appliance by holding inside the top of the compartment.

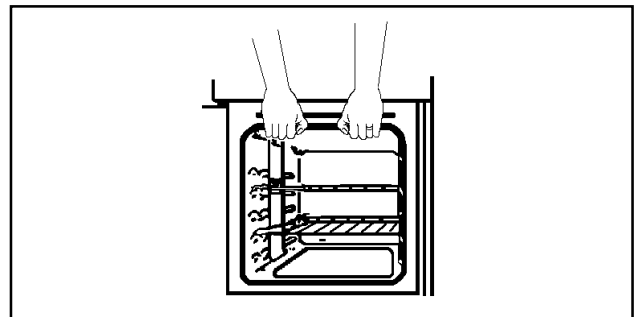

This is a type X appliance, which means it is free-standing and can be fitted with cabinets on one or both sides. It may also be fitted in a corner setting.

Side walls which are above hob level should be protected by heat resistant non-combustible material and **MUST NOT** be nearer than 40mm to the hob side.

A nominal air gap of 2mm all around the appliance is required to enable the appliance to be moved into position. It is recommended that proprietary trims are fitted to protect the worktops of either side of the appliance. These are available from most DIY stores.

Always ensure an air gap is maintained at hotplate level. Tile or other forms of deep wall covering should not obscure this gap.

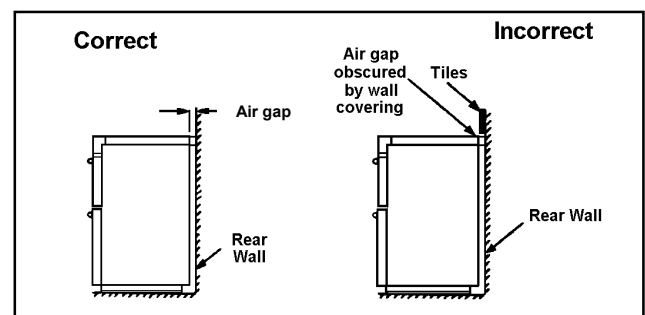

Note: Vapours from the oven vent may in time cause discolouration of wallcoverings behind the appliance. For ease of cleaning it may be preferable to tile behind the appliance.

Overhanging surfaces or a cooker hood should be a minimum of 685mm above the hob.

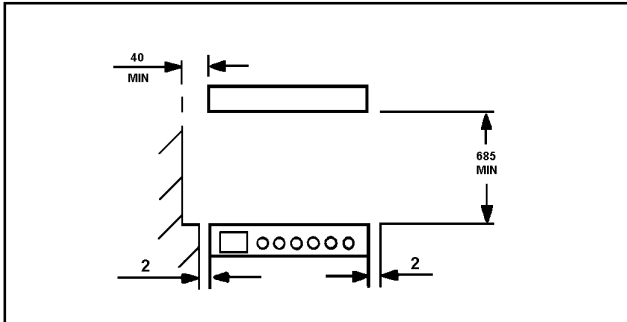

It is important to ensure that the appliance is level after installation. Levelling feet are fitted to the appliance to accommodate uneven floors.

GENERAL NOTES ON USING YOUR APPLIANCE

We suggest that you run the oven elements for 10 – 15 minutes at 220°C to burn off any residue from their surfaces. The procedure should be repeated with the grill for approximately 5 – 10 minutes. During this period an odour may be emitted, it is therefore advisable to open a window for ventilation.

ABOUT CONDENSATION AND STEAM

When food is heated it produces steam similar to a boiling kettle. The oven is vented to allow some of this steam to escape. However, always stand back from the appliance when opening the oven door to allow any build up of steam or heat to release.

If the steam comes into contact with a cool surface on the outside of the appliance, e.g. a trim, it will condense and produce water droplets. This is quite normal and is not caused by a fault on the appliance.

To prevent discolouration, regularly wipe away condensation and also soilage from surfaces.

CONTROL PANEL INDICATOR NEON

The light will indicate whether the oven is switched on, the neon also indicates when the set temperature has been reached. The neon will turn on and off during use to show that the temperature is being maintained.

GRILL AND OVEN FURNITURE

The following items of grill/oven furniture have been supplied with the appliance:

1 grill pan

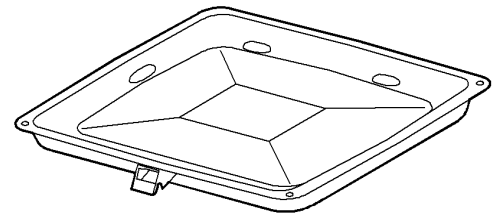

1 grill pan handle

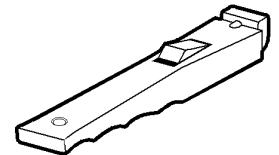

1 grill pan grid

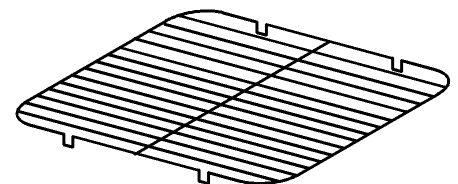

1 straight shelf for grilling only

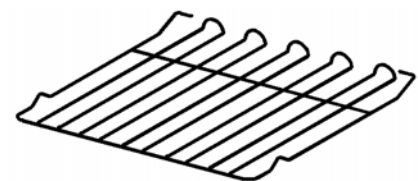

2 straight shelves for fan oven cooking

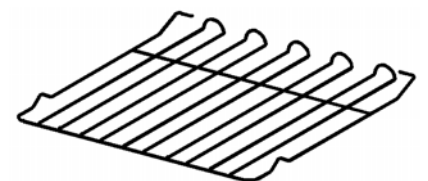

GETTING TO KNOW YOUR APPLIANCE

THE CONTROL PANEL

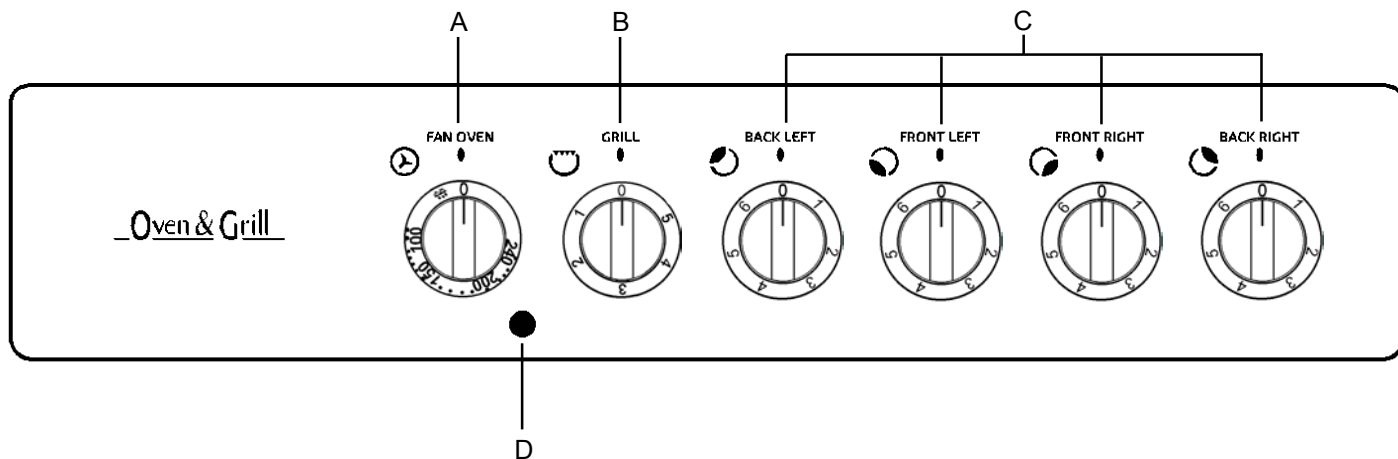

FEATURES

- A - Fan Oven Control
- B - Grill Control
- C - Hotplate Controls
- D - Fan Oven Indicator Neon

THE SEALED HOTPLATES

BEFORE USING THE HOTPLATES FOR THE FIRST TIME

Turn the control knob to a medium/high setting and allow the hotplate to heat, uncovered by a saucepan for 3-5 minutes. This hardens the protective coating on the hotplates and makes it more resistant to normal use. A harmless smoke will be given off from the hotplates.

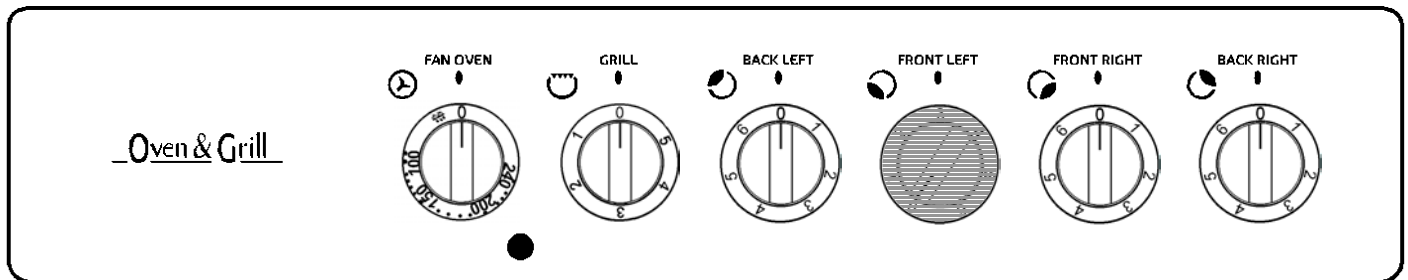

- To operate the hotplates turn the control knobs in either direction to vary the heat setting.
- The highest number represents the hottest setting and the lowest number represents the coolest setting. Choose a setting appropriate to the quantity and type of food to be cooked.

RECOMMENDED SAUCEPANS

For speed and economy only good quality saucepans with flat bases and close fitting lids are recommended.

To check the flatness of the saucepan, place a ruler across the pan base, hold at eye level and look for light showing. There should be very little or no light visible between the ruler and the pan base.

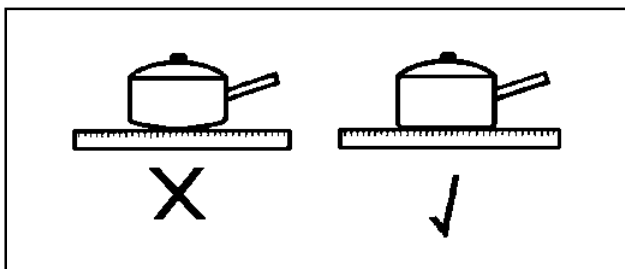

The size of the base of the saucepan should be the same or up to 2.5cm/1 inch larger than the hotplate. If the base is too small, energy will be wasted, boilovers will also be more difficult to deal with as spillage will fall directly onto the hotplate.

Pressure cookers, preserving pans etc., should comply with the recommendations given above. Traditional round bottomed Woks **must not be** used even with a stand. Woks with flat-bottomed bases are available and do comply with the above recommendations.

HINTS AND TIPS

- Lift, rather than slide saucepans on and off the hob to help reduce scratches and maintain the efficiency of the hotplates.

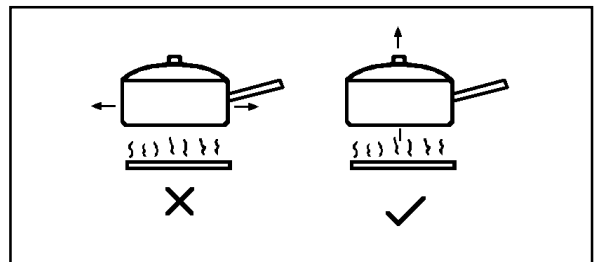

- Avoid the use of decorative covers as they can cause condensation to form on the hotplates which may lead to deterioration.
- Follow any guidelines provided by the saucepan manufacturer, particularly those relating to recommended heat settings.
- Avoid using thin, badly dented or distorted saucepans as they can lead to sticking and burning of food.

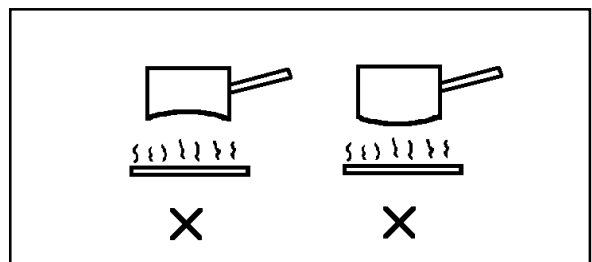

- To prolong the life of the hotplates:
 - Never use utensils with a skirt, e.g. a bucket.
 - Never use an asbestos mat.
 - Never leave the hotplates ON when not covered with a saucepan.

DEEP FAT FRYING

SPECIAL FRYING NOTE:

For safety purposes when deep fat frying, fill the pan one third full of oil, **DO NOT** cover the pan with a lid and **DO NOT** leave the pan unattended. In the unfortunate event of a fire, switch the appliance OFF at the electricity supply and cover the pan with a lid or damp cloth to assist in smothering the flames.

DO NOT use water on the fire. Leave the pan to cool for at least 30 minutes before moving it.

DO NOT leave the fat or oil in the frying pan on the hob to store it in case the hob is inadvertently switched ON.

1. Preparing the food.

Seal the food by coating with flour, egg and breadcrumbs or batter. **Do not** use a basket with batter coated foods as they will stick.

2. Amount of oil.

For safety purposes fill the pan only one-third full of oil.

3. Testing the temperature of the oil.

It is advisable to use a thermometer to test the temperature of the oil. Alternatively, drop a small cube of bread into the oil which should be brown in just under a minute if the oil is at the correct temperature of 190°C/375°F.

4. Cooking the food.

Lower the food gently into the oil. **Do Not** add too much food at once or the temperature of the oil will be reduced and may result in soggy, greasy food.

Turn the food if necessary; doughnuts float to the surface so will not brown on the upperside if not turned. Once cooked, drain the food on absorbent paper.

5. Double frying chips.

Double frying will ensure good chips. First fry the chips for a few minutes at 170°C/340°F to seal the outside. Remove the chips from the oil. Increase the temperature of the oil to 190°C/375° to finish cooking and brown the chips.

Chips may be kept for several hours after the first frying before finishing off with the second frying.

6. Frying temperatures

	Celsius Scale (°C)	Fahrenheit Scale (°F)
	150	300
First frying of potatoes	170 175 180	340 350 360
Second frying of potatoes Frying chicken and fish	190 195 200	375 380 390

PRESERVING

1. **DO NOT** use a pan that overlaps the perimeter of the hob trim.

2. To allow for a full rolling boil, the pan should be no more than one third full when all the ingredients have been added. It is better to use two pans rather than overfill one, or use half quantities.

3. Use firm fruit or vegetables and wash well before using.

4. Preserving sugar gives clear jam, however granulated sugar is cheaper and gives equally good flavour.

5. Crystallization may be caused if sugar is not completely dissolved before bringing jam to the boil. Over boiling will affect the flavour, setting properties and colour of the jam.

6. To test jam for setting:

If a jam thermometer is available, boil jam to 104°C. Marmalade should be boiled to 106°C.

If a jam thermometer is not available, remove pan from heat, place sample of jam on dish and cool quickly (i.e. in a freezer or frozen food storage compartment of a refrigerator). When cold it will crinkle and hold the mark of a finger run through it, if it is at setting point.

7. The scum should be removed as soon as possible after setting point has been reached. Marmalade should be allowed to cool before potting to prevent the peel rising.

THE GRILL

USES OF THE GRILL

CAUTION – ACCESSIBLE PARTS MAY BECOME HOT WHEN THE GRILL IS IN USE. CHILDREN SHOULD BE KEPT AWAY.

SELECTING THE GRILL

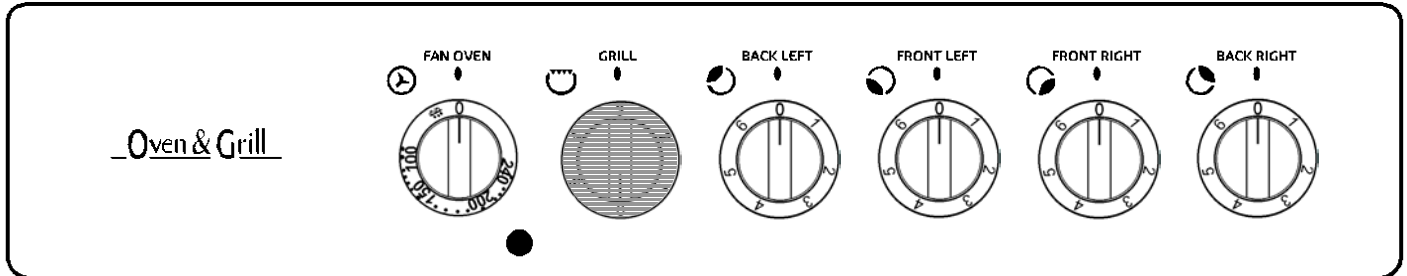

- To operate the grill open the grill door and turn the grill control in either direction.
- The highest number represents the hottest setting and the lowest number represents the coolest setting.
- Setting 5 represents the grill on Full. At lower settings the grill may turn on and off over time and you may prefer to use these settings for keeping food warm. The food will however continue to cook gently if the grill is used for this purpose.

THINGS TO NOTE

THE GRILL DOOR MUST BE LEFT OPEN DURING GRILLING.

Closing the grill door will cut OFF the power to the grill element preventing incorrect use.

Some smoke from fat splashes may be evident as the grill cleans itself.

THE GRILL PAN AND HANDLE

The grill pan is supplied with a removable handle.

To insert the handle, press the button on the handle with the thumb and pivot the handle slightly upwards inserting the lip into the widest part of the bracket. Move the handle towards the right to remove from the bracket.

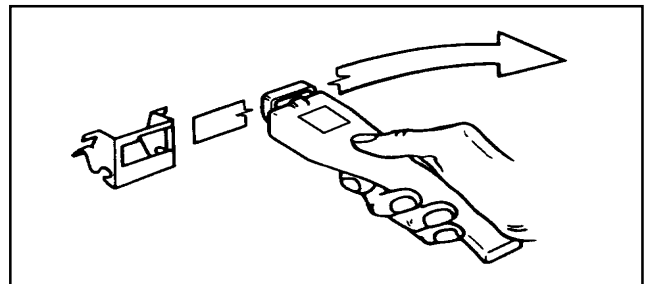

Ensure your hand is protected when removing the grill pan handle as the grill element can become very hot.

ALWAYS REMOVE THE GRILL PAN HANDLE DURING GRILLING.

To correctly locate the grill pan on the shelf, ensure that the cut out on the underside of the handle bracket locates over the front bar of the shelf.

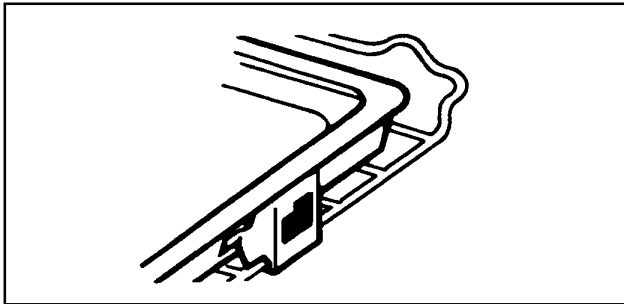

To check the progress of the food being grilled, the grill pan should be withdrawn on the shelf to attend to food during cooking.

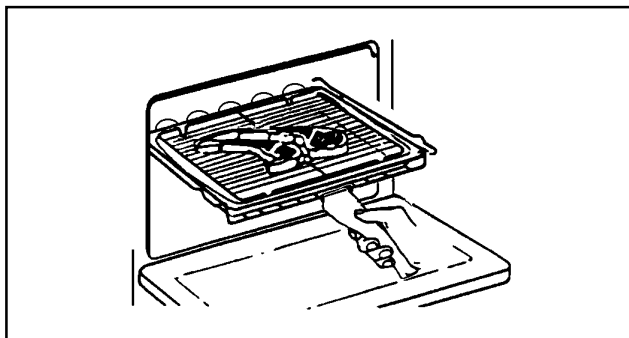

HINTS AND TIPS

- Food should be thoroughly dried before grilling to minimise splashing. Brush lean meats and fish lightly with a little oil or melted butter to keep them moist during cooking.
- Adjust the grid and grill pan runner position to allow for different thicknesses of foods.

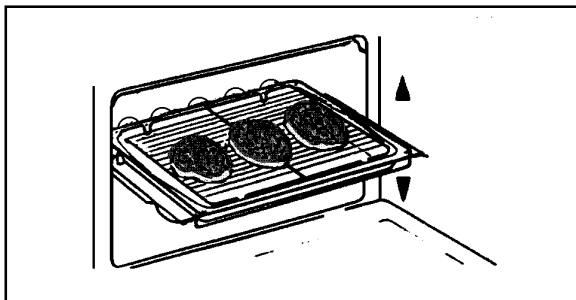

- Accompaniments such as tomatoes and mushrooms may be placed underneath the grid when grilling meats.

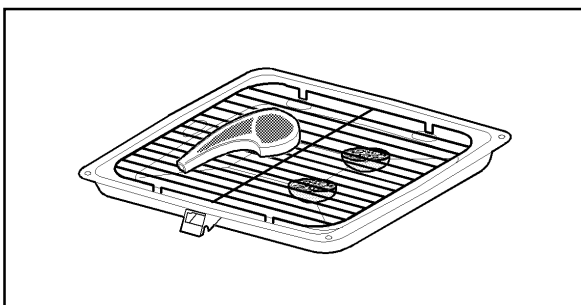

- When toasting bread use the straight shelf in position 1 with the grid in the high position.
- Preheat the grill on a full setting for a few minutes before sealing steaks or toasting. Adjust the heat setting and the shelf as necessary during cooking.
- The food should be turned over during cooking as required.

GRILLING CHART

FOOD	RUNNER POSITION	GRILL TIME (mins in total)
Bacon Rashers	1	2-3 each side
Beefburgers	1	6-10 each side
Chicken Joints	1	15-20 each side
Chops - Lamb	1	7-10 each side
Pork	1	10-15 each side
Fish – Whole	1	
Trout/Mackerel	1	8-12 each side
Filletts – Plaice/Cod	1	4-6 each side
Kebabs	1	10-15 each side
Kidneys – Lamb/Pig	1	4-6 each side
Liver – Lamb/Pig	1	5-10 each side
Sausages	1	10-15 each side
Steaks – Rare	1	3-6 each side
Medium	1	6-8 each side
Well Done	1	7-10 each side
Toasted Sandwiches	1	1¼-1½ each side

Shelf positions are counted from the bottom upwards.

The times quoted above are given as a guide and should be adjusted to suit personal taste.

THE FAN OVEN

USES OF THE FAN OVEN

PREHEATING

The fan oven quickly reaches its temperature, so it is not usually necessary to preheat the oven. Without preheating however, you may find you need to add an extra 5 – 10 minutes on the recommended cooking times. For recipes needing high temperatures, e.g. bread, pastries, scones, soufflés etc., best results are achieved if the oven is preheated first. For best results when cooking frozen or cooked chilled ready meals always preheat the oven first.

COOKING TEMPERATURES

Fan oven cooking generally requires lower temperatures than conventional cooking. Follow the temperatures recommended in the chart on page 17. As a guide reduce temperatures by about 20°C – 25°C for your own recipes, using a conventional oven.

BATCH BAKING

The fan oven cooks evenly on both shelf levels, especially useful when batch baking.

SELECTING THE FAN OVEN

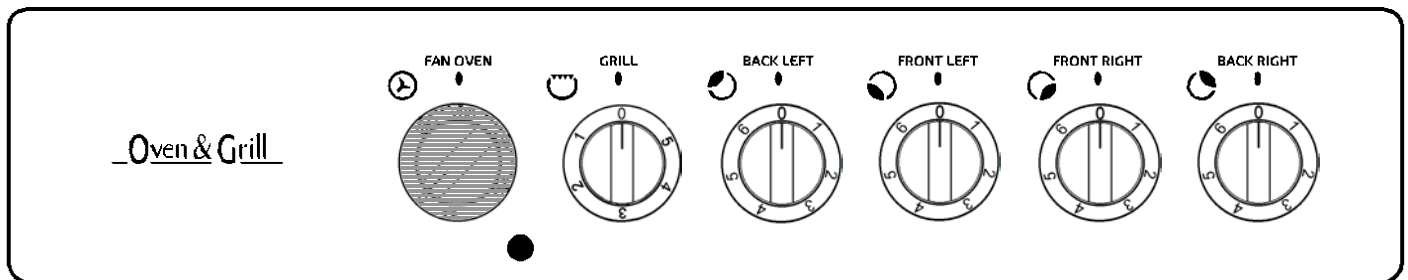

- Turn the fan oven temperature control to the required setting.

THINGS TO NOTE

The fan oven indicator neon will glow until the oven has reached the desired temperature and then go out. It will turn ON and OFF periodically during cooking showing that the temperature is being maintained.

TO FIT THE OVEN SHELVES

The shelves should be fitted with the straight rods uppermost on the frame and the forms towards the back of the oven. If not fitted correctly the anti-tilt and safety stop mechanism will be affected.

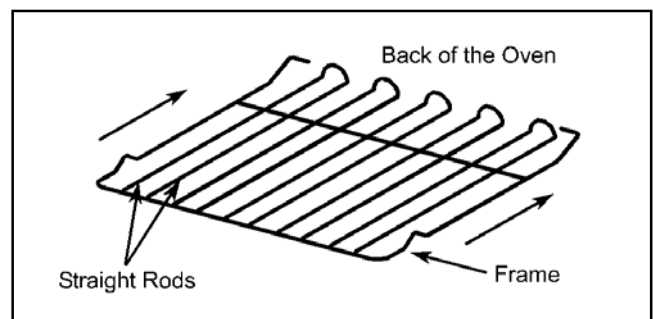

HINTS AND TIPS

- Arrange the shelves in the required positions before switching the oven ON. Shelf positions are numbered from the bottom upwards.

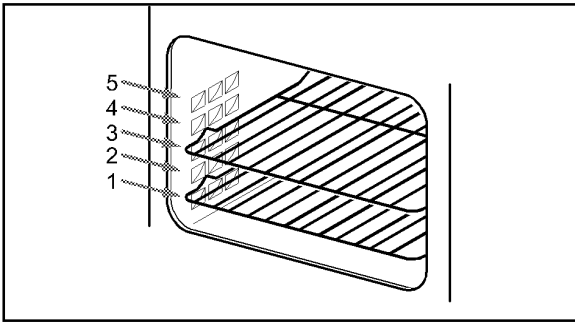

- When cooking more than one dish in the fan oven, place dishes centrally on different shelves rather than cluster several dishes on one shelf, this will allow the heat to circulate freely for the best cooking results.
- When batch baking one type of food e.g. Victoria sandwich cakes, those of similar size will be cooked in the same time.

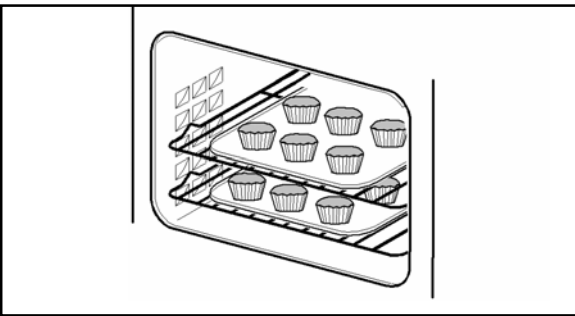

- It is recommended that when baking larger quantities, the shelf positions should be evenly spaced to suit the load being cooked. A slight increase in cooking time may be necessary.
- **DO NOT** place dishes or baking trays directly on the oven base as it interferes with the oven air circulation and can lead to base burning; use the lower shelf position.

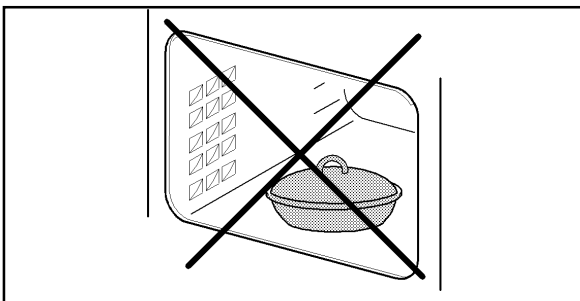

- The use of excessively high temperatures can cause uneven browning. It may be necessary to reduce the temperatures slightly. Refer to the recommendations given in the oven cooking chart on page 17.

FAN OVEN COOKING CHART

The oven temperatures are intended as a guide only. It may be necessary to increase or decrease the temperatures by 10°C to suit individual preferences and requirements.

FOOD		FAN OVEN			
		SHELF POSITION	COOKING TEMP (°C)	APPROXIMATE COOK TIME (m)	
Biscuits			180-190	10 - 20	
Bread			200-220	25 - 30	
Bread rolls/buns			200-220	15 - 20	
Cakes:	Small & Queen	Shelf positions	160-170	18 - 25	
	Sponges		160-170	18 - 20	
	Victoria Sandwich		160-170	18 - 25	
	Madeira		140-150	1¼ - 1½	
	Rich Fruit	are not	130-140	2¼ - 2½	
	Christmas		130-140	3 - 4½	
				depends on size	
		Gingerbread		140-150	1¼ - 1½
		Meringues	critical	90-100	2½ - 3h
		Flapjack		170-180	25 - 30
	Shortbread		130-140	45 - 65	
Casseroles:	Beef/Lamb	but ensure	140-160	2½ - 3h	
	Chicken		180-190	1¼-1½ h	
Convenience Foods			Follow manufacturer's instructions		
Fish		that oven	170-190	20 - 30	
Fish Pie (Potato Topped)			190-200	20 - 25	
Fruit Pies, Crumbles			190-200	40 - 50	
Milk Puddings			130-140	1½ - 2h	
Pasta Lasagne etc.		shelves are	190-200	40 - 45	
Pastry:	Choux		190-200	30 - 35	
	Eclairs, Profiteroles		170-180	20 - 30	
	Flaky/Puff Pies	evenly	210-220	25 - 40	
Shortcrust	Mince Pies		190-200	15 - 20	
	Meat Pies		190-210	25 - 35	
	Quiche, Tarts, Flans	spaced	180-210	25 - 45	
Roasting Meat, Poultry			160-180	See roasting chart	
Scones			210-220	8 - 12	
Shepherd's Pie		when more	190-200	30 - 40	
Soufflés			170-180	20 - 30	
Vegetables:	Baked Jacket		180-190	1 - 1½h	
	Roast Potatoes	than one is	180-190	1 - 1½h	
Yorkshire Puddings:	Large		210-220	25 - 40	
	Individual	used	200-210	15 - 25	

ROASTING CHART

ROASTING CHART		
INTERNAL TEMPERATURES – Rare : 50-60°C, Medium : 60-70°C, Well done : 70-80°C		
MEAT	FAN OVEN	COOKING TIME
Beef	160-180°C	20-35 minutes per ½kg (1lb) and 20-35 minutes over
Beef, boned	160-180°C	25-35 minutes per ½kg (1lb) and 25-35 minutes over
Mutton and Lamb	160-180°C	25-35 minutes per ½kg (1lb) and 25-35 minutes over
Pork and veal	160-180°C	30-40 minutes per ½kg (1lb) and 30-40 minutes over
Ham	160-180°C	30-40 minutes per ½kg (1lb) and 30-40 minutes over
Chicken	160-180°C	15-20 minutes per ½kg (1lb) and 20 minutes over
Turkey and Goose	160-180°C	15-20 minutes per ½kg (1lb) up to 3½kg (7lb) then 10 minutes per ½kg (1lb) over 3½kg (7lb)
Duck	160-180°C	25-35 minutes per ½kg (1lb) and 25-35 minutes over
Pheasant	160-180°C	35-40 minutes per ½kg (1lb) and 35-40 minutes over
Rabbit	160-180°C	20 minutes per ½kg (1lb) and 20 minutes over
Potatoes with meat	160-180°C	According to size
Potatoes without meat	180-190°C	According to size

The roasting temperatures and times given in the chart should be adequate for most joints, but slight adjustments may be required to allow for personal requirements and the shape and texture of the meat. However, lower temperatures and longer cooking times are recommended for less tender cuts or larger joints.

Wrap joints in foil if preferred, for extra browning uncover for the last 20 – 30 min. cooking time.

DEFROST FEATURE

USES OF DEFROST FEATURE

This fan oven function defrosts most foods faster than more conventional methods. It is particularly suitable for delicate frozen foods which are to be served cold e.g. cream filled gateaux, cakes covered with icings or frostings, cheesecakes, biscuits, scones, etc.

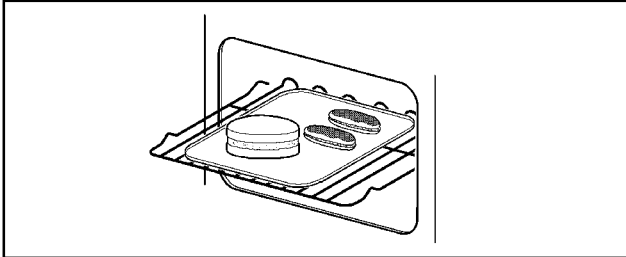

It is preferable to thaw fish, meat and poultry slowly in the fridge. However, this process can be accelerated by using the defrost function.

SELECTING DEFROST

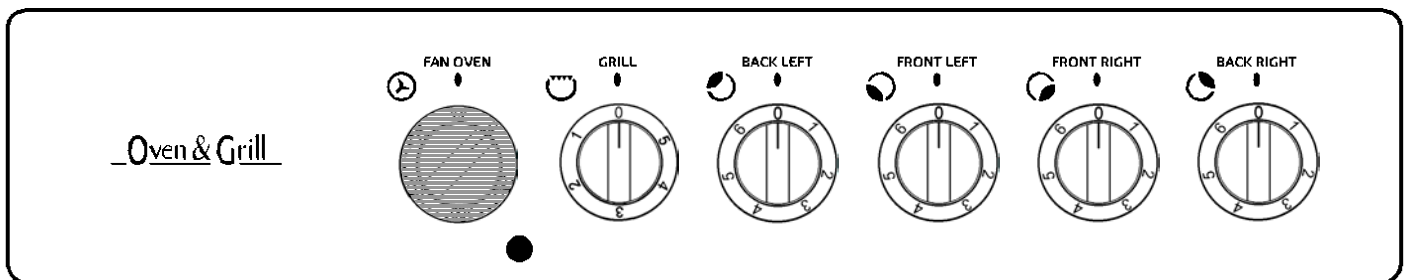

- Turn the fan oven temperature control to the defrost setting. 
- When defrost is selected, the oven indicator neon may come ON. It will stay ON until the oven reaches room temperature and then go OFF.
- It may turn ON and OFF periodically during defrosting to maintain steady room temperature inside the oven.

THINGS TO NOTE

Care must always be taken when handling foods in the home. Always follow the basic rules of food hygiene to prevent bacterial growth and cross contamination when defrosting, preparing, cooking, cooling and freezing foods.

Small or thin fish fillets, frozen peeled prawns, cubed or minced meat, liver, thin chops, steaks etc., can be thawed in 1 – 2 hours.

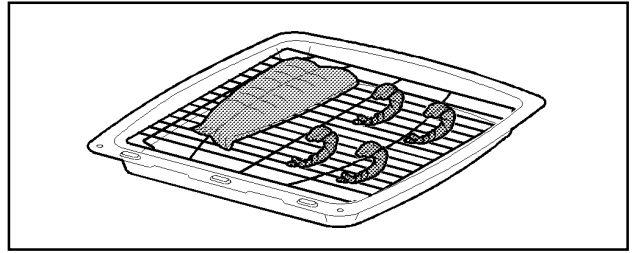

A 1kg/2¼lb oven ready chicken will be thawed in approximately 5 hours. Remove the giblets as soon as possible during the thawing process.

Joints of meat up to 2kg/4½lb in weight can be thawed using the defrost function.

ALL JOINTS OF MEAT AND POULTRY MUST BE THAWED THOROUGHLY BEFORE COOKING.

ALWAYS COOK THOROUGHLY IMMEDIATELY AFTER THAWING.

HINTS AND TIPS

- Place the frozen food in a single layer where possible and turn it over half way through the defrosting process.

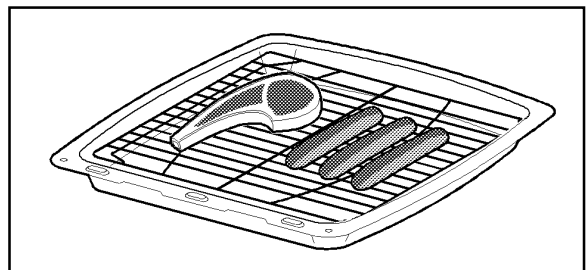

- The actual speed of defrosting is influenced by room temperature. On warm days defrosting will be faster than on cooler days.
- **DO NOT** leave food at room temperature once it is defrosted. Cook raw food immediately or store cooked food in the fridge, once it has cooled.

CARE AND CLEANING

BEFORE CLEANING THE APPLIANCE ALWAYS ALLOW THE COOLING FAN TO COOL THE APPLIANCE DOWN BEFORE SWITCHING OFF AT THE ELECTRICITY SUPPLY

CLEANING MATERIALS

Before using any cleaning materials on your appliance, check that they are suitable and that their use is recommended by the manufacturer.

Cleaners that contain bleach should NOT be used as they may dull the surface finishes. Harsh abrasives should also be avoided.

CLEANING THE OUTSIDE OF THE APPLIANCE

DO NOT use abrasive cleaning materials, or scourers on the outside of the appliance as some of the finishes are painted and damage may occur. Cleaners that contain bleach should NOT be used as they may dull the surface finishes. Regularly wipe over the control panel, splashback, oven doors and appliance sides using a soft cloth and liquid detergent.

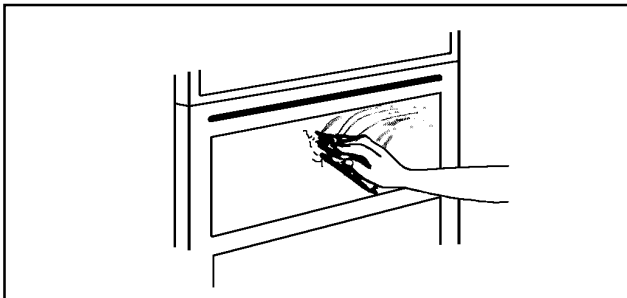

DO NOT ATTEMPT TO REMOVE ANY OF THE CONTROL KNOBS FROM THE APPLIANCE AS THIS MAY CAUSE DAMAGE AND IS A SAFETY HAZARD.

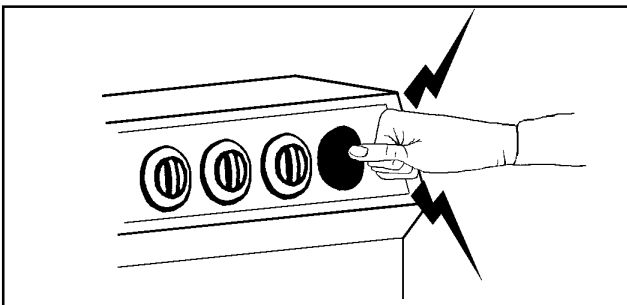

CLEANING THE SEALED HOTPLATES AND HOTPLATE TRIMS

In order to maintain the appearance of your appliance's sealed hotplates and trims, you are advised to use the recommended cleaning agents daily. If you do not allow spillages to burn on they will be much easier to clean off.

THINGS TO NOTE

The red spot in the centre of the hotplates may be removed with some abrasive cleaning agents. This is not a fault and does not affect the performance of the hotplates.

FOR NORMAL SOILAGE

Wipe over the hotplates and trims using a clean damp cloth then switch to a low or medium setting for a few minutes to thoroughly dry.

FOR HEAVY SOILAGE

Use a clean damp cloth or scourer with a cream cleaner e.g. 'Cif' or a powder cleaner e.g. 'Ajax' on the hotplate and trims. Follow the circular grooved pattern on the hotplate when cleaning. Rinse off cleaning agents thoroughly. Dry as for normal soilage.

For more stubborn marks warm the hotplate on a low setting for 30 seconds. Clean the sealed plate with 'Ajax' powder cleaner, 'Cif' cream cleaner or a 'Brillo' pad. You may have to rub hard for several minutes.

Rinse off cleaning agents thoroughly with a damp cloth. Switch to a low or medium setting for a few minutes until the hotplate is thoroughly dry.

CLEANING THE HOTPLATE TRIMS

The stainless steel trims may become straw coloured during use. Using a proprietary stainless steel cleaner, e.g. 'Shiny Sinks' will help maintain a bright appearance. Alternatively a powder cleaner such as 'Bar Keepers Friend' may be used regularly.

CLEANING THE VITREOUS ENAMEL

Use a clean damp cloth or scourer made for non-stick saucepans with 'Cif' or cream cleaner.

AFTER CLEANING

To maintain the appearance of the hotplates occasionally apply a little salt free vegetable oil or commercial restorative agent.

To apply vegetable oil, first heat the hotplate on a medium setting for 30 seconds then turn OFF. Pour a very small amount of oil onto kitchen paper, apply the paper to the hotplate and wipe off any excess oil. Heat the hotplate on a medium setting for 1 minute.

To apply restorative agent, apply a thin coating of '4 Hob' or use a 'Minky' Hotplate Cleaning Cloth following the manufacturers instructions.

CLEANING THE GRILL AND OVEN FURNITURE

All removable parts, except the grill pan handle can be washed in the dishwasher.

The grill pan, grill pan grid and oven shelves may be cleaned using a soap impregnated steel wool pad. Soaking first in hot soapy water will make cleaning easier.

CLEANING INSIDE THE OVEN AND GRILL COMPARTMENTS

The Stayclean surface on the rear oven panel should not be cleaned manually.

The vitreous enamel oven base and sides in the grill compartment and the fan oven base and sides can be cleaned using normal oven cleaners or aerosol oven cleaners with care. Ensure that the manufacturers instructions are followed and that all parts are well rinsed afterwards.

Aerosol cleaners must not be used on the Stayclean surface rear oven panel and must not come into contact with elements as this may cause damage.

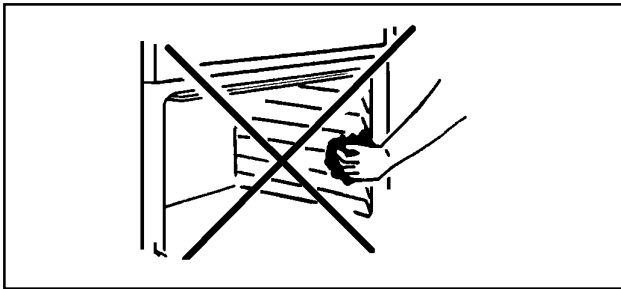

HINTS AND TIPS

- Manual cleaning of the Stayclean surfaces IS NOT recommended. Damage will occur if abrasives or aerosol sprays of any kind are used.
- The Stayclean surface destroys splashes of food and fats when the oven temperature is raised to around 220°C.
- It is a good idea to run the oven for an hour or two per week to ensure good performance from the Stayclean finish.
- Slight discolouration and polishing of the Stayclean surfaces may occur in time. This DOES NOT affect the Stayclean properties in any way.
- Follow the recommendations below to keep oven soilage to a minimum.
- Cook at the recommended temperatures. Higher temperatures during roasting will increase soilage. Try cooking at lower temperatures for an increased length of time, you will save energy and often the joint is more tender.
- Use minimal, if any, extra oil or fat when roasting meat, potatoes only require brushing with fat before cooking. Extra fat in the oven during roasting will increase splashing and soilage.
- It is not necessary to add water to a meat tin when roasting. The water and the fat juices from the joint create excessive splattering during cooking even at normal temperatures as well as causing condensation.
- Covering joints during cooking will also prevent splashing onto the interior surfaces. Removing the covering for the last 20-30 minutes will allow extra browning if required. Some large joints and turkeys especially benefit by this method of cooking, allowing the joint to cook through before the outside is over-browned.

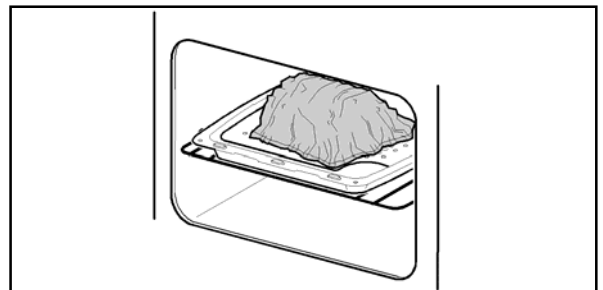

SOMETHING NOT WORKING?

Before calling an Engineer please carry out the following checks, you may be able to solve the problem without the expense of an engineer.

If our Service Engineer finds that the problem is listed below you will be charged for the call whether or not the appliance is under guarantee.

The appliance does not work at all:

- * Check that the appliance has been wired in and is switched on at the wall.
- * Check that the main appliance fuse is working.

The hotplates and oven work but the grill does not:

- * Check that you have carefully followed the instructions for the operation of the grill.

The grill does not work:

- * Check that the grill door is left open during grilling.

The oven temperature is too high or low:

- * Check that the recommended temperatures are being used (see page 17). Be prepared to adjust the temperature up or down by 10°C to achieve the results you want.
- * Care should be taken when using an oven thermometer to check oven temperatures as they may be inaccurate.

The following factors should be considered.

- * Ensure you purchase and accurate good quality instrument.
- * The oven will cycle about a set temperature and will not be constant.

If the oven is not cooking evenly or the side opening door will not stay open:

- * Check that the appliance is level.
- * Check that the recommended temperatures and shelf positions are being used.

The fan oven is noisy:

- * Check that the oven is level.
- * Check that bakeware and shelves are not vibrating in contact with the back panel in the oven.

SERVICE AND SPARE PARTS

In the event of your appliance requiring service, or if you wish to purchase spare parts, please contact your local Service Force Centre by telephoning:-

0870 5 929929

Your telephone call will be automatically routed to the Service Force Centre covering your post code area.

For the address of your local Service Force Centre and further information about Service Force, please visit the website at www.serviceforce.co.uk

Before calling out an engineer, please ensure you have read the details under the heading "Something Not Working?".

When you contact the Service Force Centre you will need to give the following details:

1. Your name, address and post code.
2. Your telephone number.
3. Clear and concise details of the fault.
4. The model and serial number of the appliance (found on the rating plate).
5. The purchase date.

Please note that a valid purchase receipt or guarantee documentation is required for in-guarantee service calls.

For Customer Service in Ireland please contact us at the address below:

Tricity Bendix
Electrolux Group (Irl) Ltd
Long Mile Road
Dublin 12
Republic of Ireland

Tel: +353 (0) 1 4090752

Email: service.eid@electrolux.ie

CUSTOMER CARE DEPARTMENT

For general enquires concerning your Tricity Bendix appliance, or for further information on Tricity Bendix products, please contact our Customer Care Department by letter or telephone at the address below;

Customer Care Department
Tricity Bendix
55 – 77 High Street
Slough
Berkshire
SL1 1DZ
Tel: 0870 5 950950 (*)

*calls to this number may be recorded for training purposes.

GUARANTEE CONDITIONS

Standard guarantee conditions

We, Tricity Bendix, undertake that if within 12 months of the date of the purchase this Tricity Bendix appliance or any part thereof is proved to be defective by reason only of faulty workmanship or materials, we will, at our option repair or replace the same FREE OF CHARGE for labour, materials or carriage on condition that:

- The appliance has been correctly installed and used only on the electricity supply stated on the rating plate.
- The appliance has been used for normal domestic purposes only, and in accordance with the manufacturer's instructions.
- The appliance has not been serviced, maintained, repaired, taken apart or tampered with by any person not authorised by us.
- All service work under this guarantee must be undertaken by a Service Force Centre.
- Any appliance or defective part replaced shall become the Company's property.
- This guarantee is in addition to your statutory and other legal rights.

Home visits are made between **8.30am** and **5.30pm** Monday to Friday. Visits may be available outside these hours in which case a **premium** will be charged.

Exclusions

This guarantee does not cover:

- Damage or calls resulting from transportation, improper use or neglect, the replacement of any light bulbs or removable parts of glass or plastic.
- Costs incurred for calls to put right an appliance which is improperly installed or calls to appliances outside the United Kingdom.
- Appliances found to be in use within a commercial environment, plus those which are subject to rental agreements.
- Products of Tricity Bendix manufacture which are not marketed by Tricity Bendix.

European Guarantee

If you should move to another country within Europe then your guarantee moves with you to your new home subject to the following qualifications:

- The guarantee starts from the date you first purchased your product.
- The guarantee is for the same period and to the same extent for labour and parts as exists in the new country of use for this brand or range of products.
- This guarantee relates to you and cannot be transferred to another user.
- Your new home is within the European Community (EC) or European Free Trade Area.
- The product is installed and used in accordance with our instructions and is only used domestically, i.e. a normal household.
- The product is installed taking into account regulations in your new country.

Before you move please contact your nearest Customer Care centre, listed below, to give them details of your new home. They will then ensure that the local Service Organisation is aware of your move and able to look after you and your appliances.

France	Senlis	+33 (0) 3 44 62 20 13
Germany	Nürnberg	+49 (0) 800 234 7378
Italy	Pordernone	+39 (0) 800117511
Sweden	Stockholm	+46 (0) 20 78 77 50
UK	Slough	+44 (0) 1753 219898
Ireland	Dublin	+353 (0) 1 4090752

NOTES

NOTES

NOTES

TRICITY BENDIX

Tricity Bendix, 55-77 High Street, Slough, Berkshire SL1 1DZ

Consumer care telephone number 08705 950950

IMPORTANT NOTICE

In line with our continuing policy of research and development, we reserve the right to alter models and specifications without prior notice.

This instruction booklet is accurate at the date of printing, but will be superseded if specifications or appearance are changed.

SE305 - 311679300

© Electrolux plc 2003

 **From the Electrolux Group. The world's No.1 choice.**

The Electrolux Group is the world's largest producer of powered appliances for kitchen, cleaning and outdoor use. More than 55 million Electrolux Group products (such as refrigerators, cookers, washing machines, vacuum cleaners, chain saws and lawn mowers) are sold each year to a value of approx. USD 14 billion in more than 150 countries around the world.

Free Manuals Download Website

<http://myh66.com>

<http://usermanuals.us>

<http://www.somanuals.com>

<http://www.4manuals.cc>

<http://www.manual-lib.com>

<http://www.404manual.com>

<http://www.luxmanual.com>

<http://aubethermostatmanual.com>

Golf course search by state

<http://golfingnear.com>

Email search by domain

<http://emailbydomain.com>

Auto manuals search

<http://auto.somanuals.com>

TV manuals search

<http://tv.somanuals.com>