

TRICITY

TMSS1710



Microwave Oven

Instruction Manual

WARNING

RISK OF ELECTRIC SHOCK. DO NOT DISMANTLE

Please follow all the precautions listed below for safety and to reduce the risk of injury or electrical shock.

- Read all the instructions and retain them.
- Before use check that the voltage stated on the rating plate on the rear of your microwave oven corresponds to your mains voltage.
- The mains socket must be well earthed. Do not plug the oven into a mains adaptor into which other units are connected.
- WARNING: If the door or door seals are damaged, the oven must not be operated until it has been repaired by a competent person.
- WARNING: It is hazardous for anyone other than a competent person to carry out any service or repair operation that involves the removal of a cover which gives protection against exposure to microwave energy;
- Do not use the microwave oven with a damaged cord or plug or after the appliance has malfunctioned or is damaged. Seek expert assistance.
- Do not touch hot surfaces. Use handles or knobs only. Allow the appliance to cool before cleaning.
- WARNING: Do not operate the microwave oven empty. This could cause damage to the oven.
- Do not immerse the body of the microwave oven or the electrical cord or plug in water or liquids.
- Do not place the microwave oven on or near a hot gas or electric burner.
- Use the appliance on a stable heat-resistant surface.
- Never leave the microwave oven unattended when it is operational.
- Make sure that the power cable does not touch any hot surface or overhang a table edge.
- Do not use the microwave oven outdoors.
- Unplug the oven when not in use and before cleaning.
- Do not obstruct the ventilation slots or place objects on top of the oven.
- Do not use attachments or accessories not recommended by the manufacturer.
- This appliance is not intended for use by persons (including children) with reduced physical, sensory or mental capabilities, or lack of experience and knowledge, unless they have been given supervision or instruction concerning use of the appliances by a person responsible for their safety
- Children should be supervised to ensure that they do not play with the appliance.
- **WARNING:** Only allow children to use the oven without supervision when adequate instructions have been given so that the child is able to use the oven in a safe way and understands the hazards of improper use.
- Heat-insulation (oven) gloves should be used when removing a hot container from the oven.
- Do not use the microwave oven for any purpose not expressly specified in this manual.
- When not in use, do not store utensils, food or other objects in the oven.
- There are no user serviceable parts in your microwave oven. Unauthorised dismantling or servicing will void the product warranty.

When cooking with your oven:

- Only use utensils that are suitable for use in microwave ovens.
- When heating food in plastic or paper containers, keep an eye on the oven due to the possibility of ignition.
- If you use plastic film when re-heating or cooking food use only film designed for microwave ovens and ensure that the film does not touch the food. If necessary, prick the film all over to allow steam to escape.
- Use your microwave oven only to heat food.
- Do not heat oil for frying, or try to fry food in the microwave oven. The oil could catch fire.
- Liquids and other foods must not be heated in sealed containers since they are liable to explode. If covered containers are used, the covers should be loose. Move such containers to and from the oven with care as food may splash and the lid may fall.
- Eggs in their shells (whether raw or cooked), fruits in thick skins and nuts in their shells should not be heated in the microwave as they may explode even after microwave heating has ended.
- Items such as potatoes, sausages and chestnuts must be peeled or pierced thoroughly before cooking.
- The contents of feeding bottles and baby food jars shall be stirred or shaken and the temperature checked before consumption, in order to avoid burns.
- Microwave heating of beverages can result in delayed eruptive boiling, therefore care must be taken when handling the container.
- Food can burn if overcooked. If you are unsure about how long to cook a food for, start with a short cooking time, and check the food regularly.
- Clean the inside of your microwave regularly and remove any food deposits.
- Failure to maintain the oven in a clean condition could lead to deterioration of the surface that could adversely affect the life of the appliance and possibly result in a hazardous situation.
- If smoke is observed, switch off or unplug the appliance and keep the door closed in order to stifle any flames.

RAW MEAT AND RAW MEAT PRODUCTS

- Meat and meat products should not be fully cooked from raw in a microwave oven. Raw meat may be partially cooked in a microwave oven but the final cooking process must be carried out by conventional

Important Safety Instructions

cooking processes, (i.e boiling, roasting, frying, grilling etc) using a conventional cooker.

- When defrosting raw meat and meat products in a microwave oven ensure the item is fully defrosted and then immediately cook the meat using conventional cooking processes.
- Always clean the oven cavity thoroughly after partially cooking or defrosting raw meat.

ELECTRICAL INFORMATION

Before using this appliance ensure that the voltage of your electricity supply is the same as that indicated on the rating plate of the appliance.

THIS APPLIANCE MUST BE EARTHED.

The disconnect device for this appliance is the mains plug. The mains plug must not be obstructed in any way and must remain readily removable from the mains supply.

GENERAL NOTES

Steam: Steam is a natural product of microwave cooking. It escapes from the vents in the appliance. These vents should never be blocked. Steam may condense in and around the oven during cooking and should be dried off after use.

Smoke: If during cooking, smoke starts to come from the oven do NOT open the oven door! Immediately switch off at the mains, unplug the oven and wait for the smoke to completely subside and the oven to fully cool down before removing the food. Before you use your microwave oven again, consult a service technician and have the oven tested.

Testing Your Oven: Place a cup of water in the oven and heat it on full power for 2 minutes. If the water gets hot the oven is working.

Dim Oven Light: During low power microwave cooking the oven light may appear to dim slightly. This is normal and not a cause for concern.

If the oven fails to work or will not respond to commands: Unplug the oven and inspect the plug fuse. If this is intact, leave the oven for 30 minutes and then plug the oven in again. The oven should now work normally.

Useful Information

TIPS FOR GOOD COOKING

Please read this section together with the Safety Guide on Page 2.

- Stir liquids and purees before during and after cooking to distribute the heat evenly. Mashed potato will cook more evenly and more thoroughly if lightly covered.
- Never tightly cover food. Always cover it loosely.
- Do not allow plastic film to touch food as it may chemically break down, melt or even catch fire and contaminate the food.
- Arrange food in the dish so that the thicker part is on the outside and the thinner part inside for more even cooking. Fold under the thin edges of fish fillets and tapered foods.
- 6-7 minutes per 500 gr. will cook most fruit and vegetables. Seafood takes less time.
- Different foods require different temperatures to cook. Add more minutes as you drop the power.
- Up to 20% of the cooking takes place after the oven turns off so always remember that your food will continue cooking after you've removed it.
- Food that takes an hour in to cook in a regular oven should take around 15 minutes in the microwave.
- Foods with baking powder should stand a few minutes before cooking to allow the leavening agents to work.
- If a recipe calls for milk and water, reduce the water.
- Rotate large items of food occasionally during cooking to encourage even heat distribution.
- Food cooks best and reheats better in a round dish or a dish with curved sides.
- Salt attracts microwaves. Don't just sprinkle it on food before cooking, stir it in or add it later.
- Fats and sugars attract microwaves - thoroughly mix sugar with other ingredients. Care should be taken when cooking foods with high sugar or fat contents as they can reach very high temperatures.
- Handle pastry-wrapped foods like mince pies carefully as the filling gets hotter than the pastry.

Hints for reheating food

- Heat leftovers and pre-cooked food to at least 70°C. Food should be hot and steaming before it is served.

- When re-heating liquids such as meat stews see that the liquid boils for around 3-5 minutes to ensure the pieces of meat are completely heated through.

Is it cooked?

- Temperature should reach 70°C for meat, fish and eggs.
- Fish should be opaque and flake easily.

Hints for defrosting

- Only defrost food in the microwave if you plan to cook the food immediately after it has thawed. Some areas of the food may begin to cook during defrosting, which can allow bacteria can flourish. **Do not cook defrosted raw meat in a microwave oven.**
- Remove the food from the wrapping, place it on a microwave safe dish. Rotate and re-arrange food during defrosting. Where appropriate, stir the food and if possible, separate the food items and remove those which have already defrosted.

About Your Microwave Oven

The microwave power output of your oven is 700 watts.

Because the temperature in a microwave oven is relatively cool you have to remember that the food can be extremely hot. Always take precautions when handling containers.

Auto Cook buttons

Your oven has 6 Auto Cook keys. These allow you to automate the cooking of a range of standard foods for greater convenience.

Radio Interference:

Operation of the microwave oven can cause interference to your radio, TV or similar equipment. When there is interference, it may be reduced or eliminated by taking the following measures:

- Clean the door and sealing surface of the oven.
- Reorient the receiving antenna of radio or television.
- Relocate the microwave oven with respect to the receiver.
- Move the microwave oven away from the receiver.

Suitable and unsuitable containers:

Use heat resistant porcelain, glass or plastic containers made for microwave ovens, otherwise there is a risk of shrinking, deforming or burning. Metal containers, or containers having metal decoration or trim are not suitable for use with your microwave oven.

Avoid containers which narrow at the top as these may cause the contents to erupt when removed from the oven.

Tesco stores stock a wide range of microwave containers and wraps designed for microwave ovens. Plastic films should not touch food as they may gas, melt or break down when hot and contaminate food.

Wax paper, oven cooking bags, parchment paper and white microwave paper towels are safe for microwave use. Wooden objects may catch fire - so avoid their use.

Do not use aluminium foil for microwave cooking unless the recipe requires it. Keep foil at least 25mm away from the oven walls. Metal skewers, ties, etc. should be removed from food before cooking.

Some basic guidelines are given in the table below.

Heat-resistant glass	✓	Ordinary glass	✗
Heatproof plastic	✓	Ordinary plastic	✗
Microwaveable film	!	Metal containers	✗
Ceramics	✓	Metal Grilles	✗
		Melamine	✗

Getting Started

Please read all the instructions and the safety notes and familiarise yourself with the features and operation of your oven before use.

Unpacking the Microwave Oven

Remove the polystyrene top packing pieces and lift out the oven. Unpack the oven completely removing all the protective tape.

Open the oven door. In the oven compartment you should find the turntable and rotating support ring. Unpack all these items.

Check the oven carefully, especially the door, door seals and the locking mechanism. If any items are missing or damaged, contact your nearest Tesco store for assistance.

If possible retain the packaging. If you dispose of the packaging, do so having regard to recycling provisions in your area.

Features and Controls

General Overview

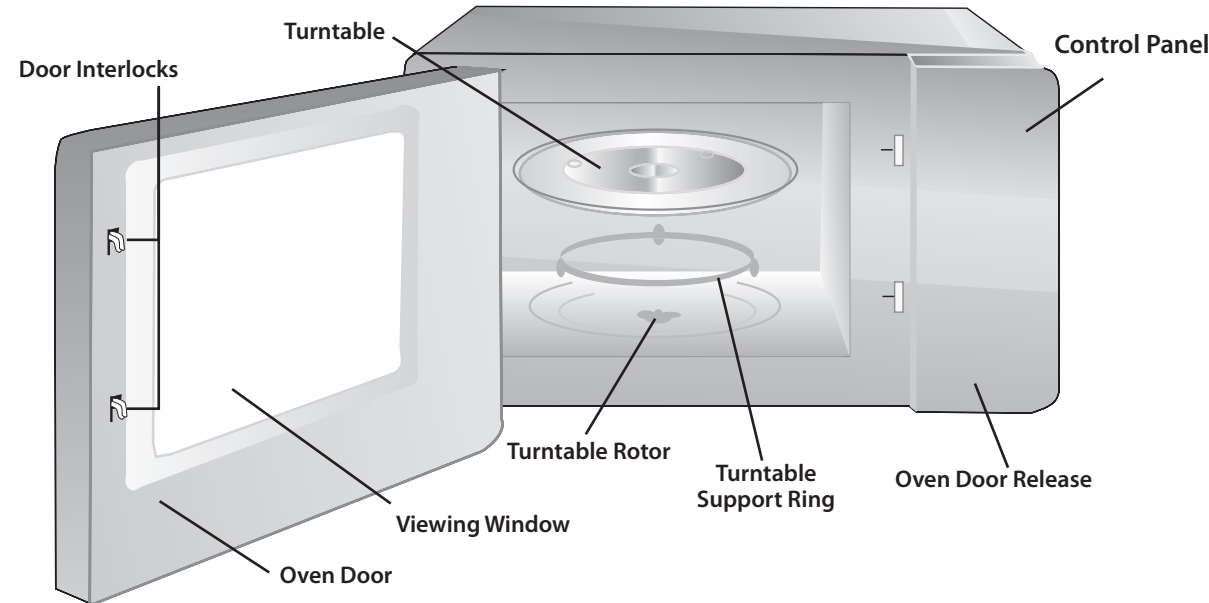

Assembly and Placement

Place your microwave oven on a flat, level stable work surface away from sources of cold, heat and damp.

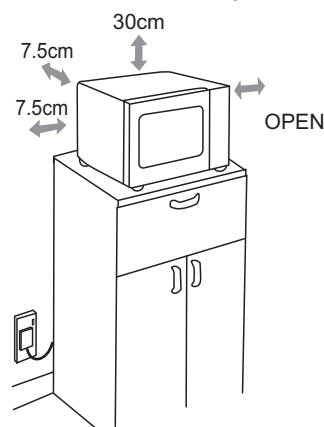

For good ventilation, the rear of the oven should have a clearance of at least 10 cm from the wall, the free distance above the top should be at least 20 cm with a gap of at least 5cm at both sides.

Remove all packing materials plastic film, etc. before connecting the oven.

Installing the Oven

Always operate your microwave oven with the turntable assembly properly installed.

Press the Door Release to open the door. Drop the Turntable Rotor gently through the hole in the centre of the oven and locate it on the spindle beneath. There is a flat machined on the spindle to hold the rotor securely during operation.

Place the support ring in the recess. Place the turntable on the support ring with the smooth side uppermost. Locate the turntable on the rotor and check that it is central to and properly supported by the ring. Refer to the drawing below.

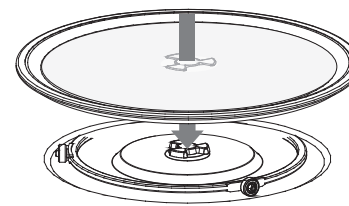

Close the door. Unwrap the power cord fully. Plug the oven directly into the wall socket.

Control Panel

1: MENU ACTION SCREEN

Clock, cooking time, power, action indicators are displayed.

2: Power Setting

Press repeatedly to choose a power setting from full power (100%) to 10%.

3: W.T/Time Defrost

Press once to defrost food by weight
Press twice to defrost food by time.
Now rotate the TIME/WEIGHT knob to set the time or weight.

4: Clock/Pre-set

Use to set the time of day or recall the time of day.

5: Stop/Clear

Press once to stop a cooking process.
Press twice to cancel a program and clear the setting.

Use to set/cancel the Child Lock.

6: Start/+30SEC./Confirm

Press to confirm an Auto-Cook process.
Touch to start cooking or defrosting.
In Quick Start mode the oven will auto-start at full power as soon as the button is pressed. Further presses of the button will extend cooking time up to a maximum of 12 minutes.

7: FUNCTION KNOB

Use with other controls to set the Clock Time, Weight and Auto Defrost settings.
From STOP, use to set an Auto Cook Programme.

8: DOOR RELEASE

Press to open the oven door.

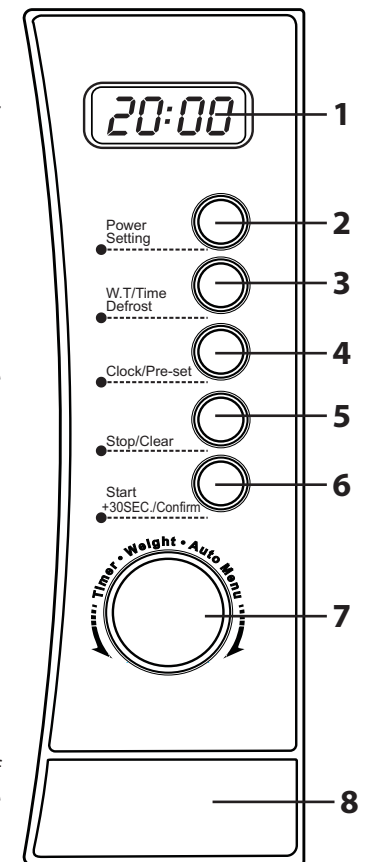

Operation - 1

GETTING STARTED

Plug the oven in

Switch on at the mains point.

The screen will display



SETTING THE CLOCK

The clock is a 24 hour clock. To enter a time of 8:30 pm

- Press the Clock/Pre-set button



- Rotate the **Function** knob to select 20 hours.

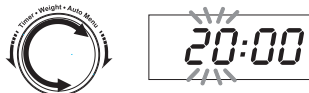

- Press Clock/Pre-set again



- Rotate the **Function** knob to select 30 minutes



- Press Clock/Pre-set again



The time is set To reset the clock follow the above procedure.

BASIC COOKING

- Press the Door Release to open the oven door.
- Place the food in a suitable container. Site the container centrally within the rim of the turntable. Close the door.
- Rotate the **Function** knob one click to the left
- Rotate the **Function** knob in either direction to set a cooking time from 10 seconds to a maximum of 95 minutes.

Each click increases/decreases the time interval as follows:

0-1 min : 5 seconds : 1-5 min : 10 seconds : 5-10 min : 30 seconds

10-30 min : 1 minute : 30-95 min : 5 minute intervals

- Press **Start/+30SEC./Confirm**. The oven will commence cooking at full power. The clock displays the remaining time left for the cooking programme.

- Example: Cook food at full power for 10 min.**

- Rotate the **Function** knob one click to the **left**



- Rotate the **Function** knob to set 10 minutes

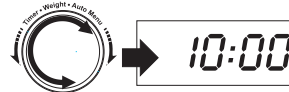

- Press **Start/+30SEC./Confirm** to start cooking

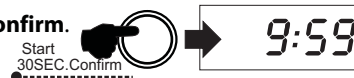

STOPPING THE OVEN

Open the door to interrupt cooking. To continue cooking, close the oven door and press the **Start/30SEC. Confirm** button.

Press Stop/Clear:

The cooking process is interrupted.



To continue cooking press the **Start/+30SEC./Confirm** button.

Pressing Stop/Clear twice will stop the oven and any cooking programme will be erased.

WHEN COOKING HAS ENDED

The oven will beep 5 times

The clock time will re-appear.



- Open the door and remove the food. Close the door

VARYING THE POWER LEVEL

The default setting of the oven is full (100%) power. Many recipes call for lower power settings. There are 5 power settings available on your oven. 100% - 80% - 50% - 30% - 10%

To alter the microwave power level

Press **Power Setting**.



Rotate the **Function** knob



Repeatedly pressing **Power Setting** will also vary the Power level..

Example: Cook food at 50% power for 10 min.

- Press the **Power Setting** button



- Rotate the **Function** knob to select 50% power



- Press **Start/+30SEC./Confirm**



- Rotate the **Function** knob to set 10 minutes



- Press **Start/+30SEC./Confirm** to start cooking



QUICK START (EXPRESS) COOKING

By pressing the **Start/+30SEC./Confirm** button repeatedly you can program the oven for Express cooking. at FULL power(100%).

- Each press of the **Start/+30SEC./Confirm** button increases the cooking time in **30 second** intervals.
- The oven will start almost as soon you press the **Start/+30SEC./Confirm** button so be prepared!!
- During the cooking cycle, you can top up the remaining time to a maximum of 95 minutes by further presses of the **Start/+30SEC./Confirm** button.
- Express cooking is a very good way of rapidly heating small portions of food, or easily adding a small amount of cooking time to finish dishes that are slightly undercooked.



All cooking programs can be set up with the oven door open or closed with the exception of the Quick Start program which requires the door to be closed.

If you are setting up a program when the door is open, pressing the **Stop/Clear** button once will erase the program.

AUTO DEFROST

There are two auto-defrosting programmes

DEFROST PROGRAMME 1 (DEF 1) - defrost by weight. You can auto defrost 100g to 2kg of food (in 100g increments)

DEFROST PROGRAMME 2 (DEF 2) - defrost by time.

Example 1: Auto Defrost 1 kg of food

- Press **W.T/Time Defrost**



- Dial in the weight of the food

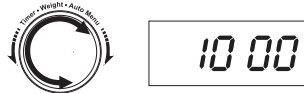

- Press **Start/+30SEC./Confirm** to start cooking

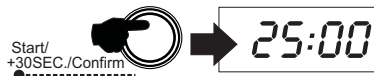

The programme automatically calculates the time required.

Example 2. Auto-Defrost food for 20 minutes

- Press **W.T/Time Defrost** twice



- Dial in the time

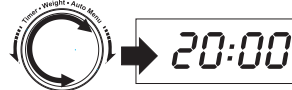

- Press **Start/+30SEC./Confirm** to start cooking



During Defrosting:

- It is good practice to periodically check food during the defrosting process, turning it if necessary.

After Defrosting:

- Open the oven door. Remove the food and check that it has fully defrosted. If the food is partially defrosted, replace it in the oven and re-select Auto Defrost programme 2 (DEF 2) and add sufficient time to fully defrost the food.

AUTO COOKING

Your oven can calculate the cooking time of various foods. Just select the program from the table below and enter the weight.

The results of auto-cooking depend on many factors, the actual type of food, the temperature it goes into the oven at, etc. If after the program has ended the food is underdone, use the Basic Cooking Procedure for a short time to complete the process.

- Rotate the **Function** knob to the **right**. Each click brings up an Auto cook Menu. There are 8 menus.



- Press **Start/+30SEC./Confirm**



- Dial in the weight (use the table below)



ROTATE TO THE RIGHT TO INCREASE WEIGHT
ROTATE TO THE LEFT TO DECREASE WEIGHT

MENU	SUGGESTED FOOD	POWER	NUMBER OF CLICKS		
			1	2	3
A-1	Reheat Food	100%	200g	400g	600g
A-2	Most Vegetables	100%	200g	300g	400g
A-3	Fish	80%	250g	350g	450g
A-5	Pasta*	80%	50g plus 450g water	100g plus 750g water	
A-6	Baked Potato	100%	200g	400g	600g
A-7	Pizza	100%	200g	400g	
A-8	Soup	80%	200g	400g	450g

***NOTE:** Add enough boiling water to the food before cooking.

- Press **Start/+30SEC./Confirm**



Example: Auto Cook 450g of Fish:

- Select **Fish: Menu A-3**



- Press **Start/+30SEC./Confirm**



Select 450 grammes



- Press **Start/+30SEC./Confirm** to start cooking



ADDING TIME DURING COOKING



During normal cooking and defrosting, you can increase the cooking time by repeatedly pressing the START/QUICK START button.

You cannot add time during the 'Defrost by Weight' and 'Auto-Cook' programs

CHILD LOCK

The Child safety lock prevents operation by small children. All oven functions are disabled including the clock when the child lock is on.

- Press and hold the **Stop/Clear** button for about five seconds after which time a beep sounds and the LOCK indicator appears.



- To cancel, press and hold the **Stop/Clear** button until the beep sounds and the clock re-appears.

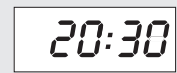

MULTI-STAGE COOKING

You can combine two cooking processes in a multi-stage programme. There are two main uses for this process.

A Cook food for a period at one power setting and then finish with another power setting. You can for example, cook food and then keep it warm by setting a low power for the second process

B Defrost food and then cook it in one combined process.

After the first stage, the buzzer will sound once and the next stage will automatically start.

! If you are defrosting food, this must always be the first process.
The Auto-Cook program cannot be combined with a multi-stage cooking process.

Example: Defrost the food for 20 minutes, then cook at 50% microwave power for 10 minutes.

1 Press **W.T/Time Defrost** Twice



2 Dial in the time

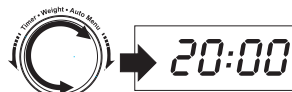

3 Press the **Power Setting** button



4 Rotate the **Function** knob to select 50% power



5 Press **Start/+30SEC./Confirm**



6 Rotate the **Function** knob to set 10 minutes

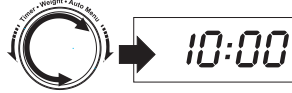

7 Press **Start/+30SEC./Confirm**

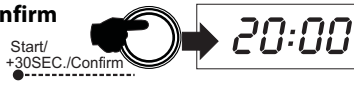

The defrost cycle will commence. When the defrost cycle has ended the oven will move on to the cooking process.

TIME DELAYED COOKING

You can preset the time at which the cooking process starts.

A Make sure the clock is set to the correct time

B Input the cooking program. Do NOT press the START button

C Set the clock to the required start time -see Page 3

D Press **START/QUICK START** to set the programme.

Example: Cook food at 50% power for 10 min starting at 21:20

Press the **Power Setting** button.



Select 50% power.



Press **Start/+30SEC./Confirm**



Rotate the **Function** knob to set 10 minutes



Press the **Clock/Pre-set** button



Rotate the **Function** knob to select 21 hours.



Press the **Clock/Pre-set** button again.



Rotate the **Function** knob to select 20 minutes



Press **Start/+30SEC./Confirm**

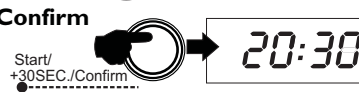

The display reverts to clock time: When the preset time comes the buzzer sounds twice and the oven will begin the programme.

When Time Delayed cooking is preset:

You cannot operate other oven functions.

Press **Stop/Clear** to clear a Pre-set program and revert to normal operation.

NOTES ON TIME DELAYED COOKING:

You can use a single program, a multistage program or an Auto-cook menu. You cannot use Express or Basic cooking. Do not use raw or frozen fish products or foods which may deteriorate during the waiting period. Do not use time-delayed cooking with a defrost programme. The clock must be set!

QUERIES

- **During cooking:** press the POWER button to briefly display the microwave power in the current programme.
- **During cooking:** press the CLOCK button to briefly display the clock time.
- **In Time Delay mode:** pressing the CLOCK button will briefly display the start time of the pre-set process.

DISPLAYS AND OVEN STATES

- Every time you press a button, the oven will beep once. If the button is not fully depressed, or the action is not part of the process you will not hear a beep and nothing will happen..
- When you first rotate the **Function** knob in either direction during a cooking process the oven will beep once.
- When setting a cooking process, if you do not confirm the process by pressing the **Start/+30SEC./Confirm** button within one minute, the process will be cancelled and the oven will revert to displaying the clock time.
- The buzzer will sound five times to remind you when cooking is finished.
- Before inputting any cooking process, it is good practice to press the **Stop/Clear** button twice to clear the oven memory.

TROUBLESHOOTING: If the oven fails to operate:

- Check that the oven is plugged in securely. If it is not, unplug from the outlet, wait 10 seconds and plug it in again securely.
- Check for a blown fuse or a tripped circuit breaker. If these are intact, test the outlet with another appliance.
- Check that the clock is set and that the child lock is off.
- Make sure that the oven door closes fully and securely.

If none of the above rectifies the situation, contact the Tesco helpline. **Do not try to adjust or repair the oven yourself.**

Care, Warranty & Specifications

Suggested Cooking Times

APPROXIMATE COOKING TIMES FOR FISH (ON FULL POWER)

Item	Weight	Cooking Time	Standing Time
Cod fillets	450g	3-4 minutes	4-10 minutes
Cod steaks	225g	3-4 minutes	4-10 minutes
Haddock fillets	225g	3-4 minutes	4-10 minutes
Kipper fillets	450g	3.4 minutes	4-6 minutes
Plaice fillets	225g	3-4 minutes	6-8 minutes
Trout (2 fish, gutted but whole) turn fish over half way through		3.5-5 minutes	4-6 minutes

The times given above are approximate and should be adjusted to suit portion sizes and individual taste. The average cooking time for fish is around 3.5 minutes per 450 g (1 lb). The fish should be lightly covered during the standing period. Temperature of the fish should reach 70° C. The fish should be opaque and flake easily.

APPROXIMATE COOKING TIMES FOR FRESH VEGETABLES (ON FULL POWER)

Item	Weight	Added water	Cooking Time
Aubergines (peeled and diced)	450g	30-40 ml	4.5-5.5 minutes
Broccoli (trimmed and sliced into spears)	225g	50 ml	3.5-4.5 minutes
Brussels Sprouts(peeled)	225g	50 ml	5.5-7.5 minutes
Carrots (diced)	225g	30 ml	5.5-7.5 minutes
Cauliflower (in florets)	450g	50-60 ml	7-9 minutes
Courgettes (diced or sliced)	450g	10 ml	5.5-7.5 minutes
Peas (removed from pods)	225g	40-50 ml	4.5-5.5 minutes
Potatoes, jacket (2, scrubbed and pierced all round)	225g	None	7-9 minutes
Potatoes, (in 40mm pieces)	450 g	40-50 ml	6-7 minutes
Spinach (shredded)	225g	None	3.5-5.5 minutes

The times given above are approximate and should be adjusted to suit quantities, portion sizes and individual taste. The average cooking time for vegetables is around 5.5 minutes per 450 g (1 lb). When adding salt, mix it with the water or add it after cooking. To cook vegetables: Mix them with the water in a ceramic curved bottomed bowl and cover lightly. After cooking leave the vegetables to stand for 2-3 minutes before straining (if necessary) and serving.

CLEANING AND CARE

These steps should be taken after every use.

- Disconnect the power supply and wait for the appliance to completely cool down.
- Remove the turntable support ring and the turntable and wash then in warm soapy water.
- Clean the oven cavity, the outer edge of the cavity, and the oven door with water and a mild detergent. A special microwave oven cleaner is not necessary. Do not use scouring pads, or other abrasives.
- Wipe outer surfaces and control panel with a damp soft cloth.
- If liquids have been splashed on the wall of the oven cavity, they must be fully removed otherwise smoke may occur when the appliance is next used.
- If the cavity emits odours, boil a cup of water with a squeeze of lemon juice for 5-7 min. to remove them.
- Dry all parts thoroughly and replace them.

WARRANTY

Your Tesco appliance is covered by a warranty for 12 months from the date of purchase. If a fault develops during this period, please contact the TESCO electrical help line on 0845 456 6767. Please have your original purchase receipt with you when you call. This warranty in no way affects your consumer rights.

SPECIFICATIONS

Mains Supply: 230V-240V AC, 50 Hz: 1150W

Microwave Output: 700 Watts

Dimensions: 258mm(H)×440mm(W)×345mm(D)

Oven Capacity: 17 Litres

Microwave Frequency; 2,450 MHz

Net Weight: 10.7 kg

TRICITY

Tesco Stores Ltd, Delamare Road,
Cheshunt, Herts, EN8 9SL



UK: Waste electrical products should not be disposed of with household waste. Separate disposal facilities exist, for your nearest facilities see www.recycle-more.co.uk or in-store for details.

ROI: Produced after 13th August 2005. Waste electrical products should not be disposed of with household waste. Please recycle where facilities exist. Check with your Local Authority or retailer for recycling advice.

Free Manuals Download Website

<http://myh66.com>

<http://usermanuals.us>

<http://www.somanuals.com>

<http://www.4manuals.cc>

<http://www.manual-lib.com>

<http://www.404manual.com>

<http://www.luxmanual.com>

<http://aubethermostatmanual.com>

Golf course search by state

<http://golfingnear.com>

Email search by domain

<http://emailbydomain.com>

Auto manuals search

<http://auto.somanuals.com>

TV manuals search

<http://tv.somanuals.com>