



900 mm Built In Oven

OPERATING AND INSTALLATION INSTRUCTIONS

MODEL NO.
BD 912/2

TECHNICAL DETAILS

MODEL NO. BD 912/2

Voltage:	230/240 Volts AC 50Hz
Wattage:	5.0/5.4kW
Height:	885mm
Width:	595mm
Depth:	545mm (excluding handles and knobs)
Weight:	53kg

This appliance complies with: European Council Directive 73/23/EEC.
EMC Directive 89/336/EEC.
CE Marking Directive 93/68/EEC.

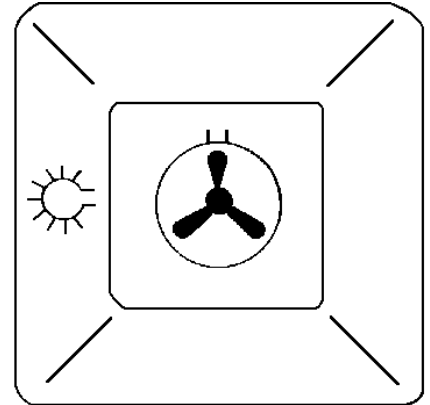
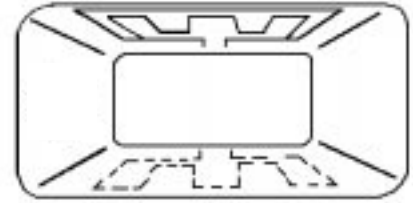

CONTENTS

Please follow these instructions step by step to install and operate your oven safely and easily.

Technical Details	2
Contents	3
Preface	5
Safety	6
Before Installation	6
During Operation	6
After Use	7
General	7
Installation Instructions	8
Things You Need to Know	8
Warnings	8
Things to Note	8
Getting Things Ready	8
Choice of Electrical Connection	8
Preparing Cabinet for Fitting Oven	9
Recommended Cabinet Dimensions	10
How to Finish Unpacking	11
Tools Required	11
Making the Electrical Connections	11
Preparing Cable	11
To Remove Cover of Mains Terminal	11
Connecting to the Mains Terminal	12
Connecting to a Hob or Cooker Point	12
Checking Electrical Connections	12
Fitting Into The Cabinet	13
Introduction	14
Getting to Know Your Oven	14
Rating Plate	15
General Notes on Using The Ovens	15
About Condensation and Steam	15
Cookware	15
The Cooling Fan for the Controls	15
Control Panel Indicator Neons	15
Grill and Oven Furniture	16
The Oven Timer	17
The Grill	20
Uses of the Dual Grill	20
Selecting the Dual Grill	20
Things to Note	20
The Grill Pan and Handle	20
Hints and Tips	21
Grilling Chart	22

CONTENTS

The Second Oven	23
Uses of the Second Oven	23
Selecting the Second Oven	23
Things to Note	23
To Fit the Top Oven Shelf	23
Hints and Tips	23
The Main Fan Oven	25
Uses of the Fan Oven	25
Selecting the Fan Oven	25
Things to Note	25
To Fit the Main Oven Shelves	26
Hints and Tips	26
Oven Cooking Chart	27
Roasting Chart	28
Defrosting	29
Uses of Defrost Feature	29
Selecting Defrost	29
Things to Note	29
Hints and Tips	29
Helpful Hints when Buying and Preparing Food	30
Care and Cleaning	31
Cleaning Materials	31
Cleaning the Outside of the Cooker	31
Cleaning Inside the Ovens	31
Cleaning the Grill Deflector, Meat Tin, Grill Pan, Grill Pan Grid and Oven Shelves ..	31
Cleaning Between the Outer and Inner Door Glass	31
Cleaning inside the Oven and Grill Compartments	32
Care of Stayclean Surfaces	32
Hints and Tips	32
Replacing the Oven Light Bulb	33
Something Not Working?	34
Service and Spare Parts	35
Customer Service Centres	36
Guarantee Conditions	38

PREFACE

Dear Customer,

Thank you for buying a Tricity Bendix cooker. With our 80 years experience in developing and manufacturing the very best in U.K. cookers, you can be assured that you have purchased a hard working, reliable, quality cooker.

Tricity Bendix cookers comply with British Standard safety and performance requirements. They have been approved by BEAB (British Electrotechnical Approvals Board) and are covered by a 12 month parts and labour guarantee.

To get the best from your new Tricity Bendix cooker, we ask that you PLEASE READ THESE INSTRUCTIONS CAREFULLY. Particular attention should be made to cooking times and temperatures which may differ from your previous cooker.

It is most important that this instruction book is retained with the cooker for future reference. Should the cooker be sold, or transferred to another owner, or should you move house and leave the cooker, always ensure that the book remains with the cooker so that the new owner can be acquainted with the functioning of the cooker and the relevant warnings.

Please read the whole instruction book before attempting to use the cooker ensuring you follow the recommendations given.



SAFETY

THESE WARNINGS ARE PROVIDED IN THE INTERESTS OF YOUR SAFETY. ENSURE THAT YOU UNDERSTAND THEM ALL BEFORE INSTALLING OR USING THE COOKER.

PLEASE
READ
CAREFULLY

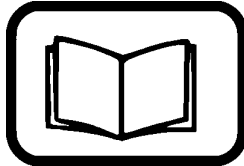

BEFORE INSTALLATION



This cooker is heavy and care **must** be taken when moving it.



Ensure that all packaging, both inside and outside the cooker has been removed before the cooker is used.



Do not try to move the cooker by pulling the door handles. Refer to installation instructions.



The cooker must be installed according to the instructions supplied. Any electrical installation work **must** be undertaken by a qualified electrician/competent person.

It is dangerous to alter or modify the specifications of the cooker in any way.



After installation, please dispose of the packaging with due regard to safety and the environment.

DURING OPERATION



Do not use this cooker if it is in contact with water and never operate it with wet hands.



This cooker is designed to be operated by adults. Young children **must not** be allowed to tamper with the cooker or play with the controls.

Accessible parts, especially around the grill area, may become hot when the cooker is in use. Children should be **kept away** until it has cooled.



Take **great care** when heating fats and oils as they will ignite if they become too hot.

This cooker has been designed for cooking edible foodstuffs only, and **must not** be used for any other purposes.



Never place plastic or any other material which may melt in the oven.



Ensure cooking utensils are large enough to contain foods to prevent spillages and boil overs.



Take care to follow the recommendations given for tending the food when grilling. Use the handle provided in the recommended way.



Do not leave the handle in position, when grilling, as it will become hot.



Always use oven gloves to remove and replace food in the oven. Similarly always use oven gloves to remove and replace the grill pan handle, when grilling. Recommendations given on page 20.



Ensure that you support the grill pan when it is in the withdrawn or partially withdrawn position.

Ensure that all vents are left unobstructed to ensure ventilation of the oven.



You must ensure that the grill control is in the 'OFF' position when the timer control has been set for automatic cooking.

Ensure that the anti-tilt shelves are put in place correctly. Refer to instructions on pages 23 and 26.



Never line any part of the cooker with aluminium foil. Do not allow heatproof cooking material, e.g. roasting bags, to come into contact with oven elements.



Always stand back from the cooker when opening the oven door to allow any build up of steam or heat to release.



Stand clear when opening the drop down oven door. **Do not** allow it to fall open - support it using the door handle, until it is fully open.



Do not place sealed cans or aerosols inside the oven. They may explode if they are heated.

AFTER USE

Ensure that all control knobs are in the OFF position when not in use.



For hygiene and safety reasons this cooker should be kept clean at all times. A build-up of fats or other foodstuffs could result in a fire, especially in the grill pan.



Do not leave utensils containing foodstuffs, e.g. fat or oil in or on the cooker in case it is inadvertently switched ON.

Cookers and hobs become **very hot**, and retain their heat for a long period of time after use. Children should be kept well away from the cooker until it has cooled.

GENERAL



Under no circumstances should repairs be carried out by inexperienced persons as this may cause injury or serious malfunction. This cooker should be serviced by an authorised Service Engineer and only genuine approved spare parts should be used. Details of servicing and repair arrangements are supplied on page 35 of this book.



Do not stand on the cooker or on the open oven door.



Do not hang towels, dishcloths or clothes from the cooker or its handle. They are a safety hazard.

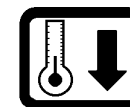

Always allow the cooling fan to cool the cooker down before switching off at the wall prior to carrying out any cleaning or maintenance work.



Only clean this cooker in accordance with the instructions given in this book.

Your safety is of paramount importance.

Therefore, if you are unsure about any of the meanings of these WARNINGS contact the:

**Consumer Care Department
Telephone: (01635) 525542**

INSTALLATION INSTRUCTIONS

THINGS YOU NEED TO KNOW

WARNINGS:

- This cooker must be installed by a qualified electrician/competent person. Safety may be impaired if installation is not carried out in accordance with these instructions.
- This cooker must be earthed.
- Do not remove the screws from the earth tab extending from the oven mains terminal block (Fig. 6).
- Before connecting the cooker make sure that the voltage of your electricity supply is the same as that indicated on the rating plate. The rating plate can be seen by opening the oven door and looking below the oven door seal.
- Do not alter the electrical circuitry of this cooker.

THINGS TO NOTE

- This cooker is designed to be fitted in cabinets of the recommended dimensions as shown (Fig. 2).
- If your cabinet interior dimension is between 565-570mm the oven may still be fitted. However a minor modification to the cabinet will be required.
- The dimensions given provide adequate air circulation around the unit within the cabinet, ensuring compliance with BS EN60-335.
- Enquiries regarding the installation of the cooker point, if required, should be made to your Regional Electricity Company to ensure compliance with their regulations.
- The cooker socket switch should be outside the cabinet but within 2m of the cooker to make it accessible to switch off the cooker in case of an emergency.
- To protect the hands, wear gloves when lifting the oven into its housing.

NOTE: HOUSE CIRCUIT

Earth leakage and continuity tests must be carried out before the cooker is connected to the mains supply and re-checked after fitting.

GETTING THINGS READY

CHOICE OF ELECTRICAL CONNECTION

- There are three possible ways to connect your cooker. In each case the cooker should be operated using at least 6mm² twin core and earth PVC insulated multicore cable. Please choose from the most appropriate after reading the different methods:-
- a) By connecting the cooker to a cooker point (having a double pole isolating switch with at least 3mm contact separation in all poles and neutral) and protected with a fuse or miniature circuit breaker at your mains fuse box.

Subject to Regional Electricity Companies regulations if you wish to connect the oven and hob to the power supply you may use one of the following two methods:-

- b) By connecting the cooker together with a hob directly to a cooker point(s). Having a double pole isolating switch with at least 3mm contact separation in all poles and neutral.
- c) If you wish to connect an oven and a hob to a cooker point you can by connecting the oven and hob separately to the cooker point. Oven and hob units should be separately connected to a control panel. See Fig. 1.

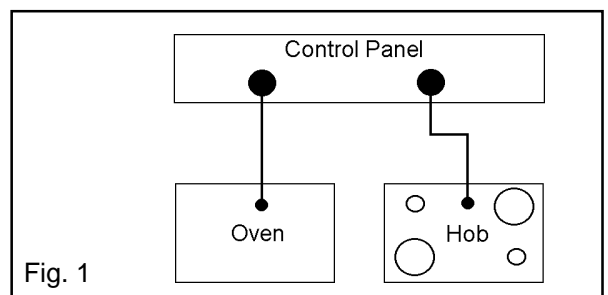

Fig. 1

NOTE: It is good practice to:

- Fit an Earth Leakage Circuit Breaker to your house wiring.
- Wire your appliance to the latest IEE regulations.

PREPARING CABINET FOR FITTING OF OVEN

- Make sure the cabinet is the correct size for the appliance to be fitted (Ref. Fig. 2).
- If the size is between 565-570mm, then the cabinet should be modified so that at the screw fixing points the recommended dimension of at least 560-565mm is maintained. The modification should ideally be localised to ensure that after screw fitment the oven is **securely** fixed into position.
- The cabinet must be stable and level by firmly securing it to the wall or floor. If necessary, make arrangements to ensure the shelf upon which the oven will rest is level.

RECOMMENDED CABINET DIMENSIONS (IN MILLIMETRES)

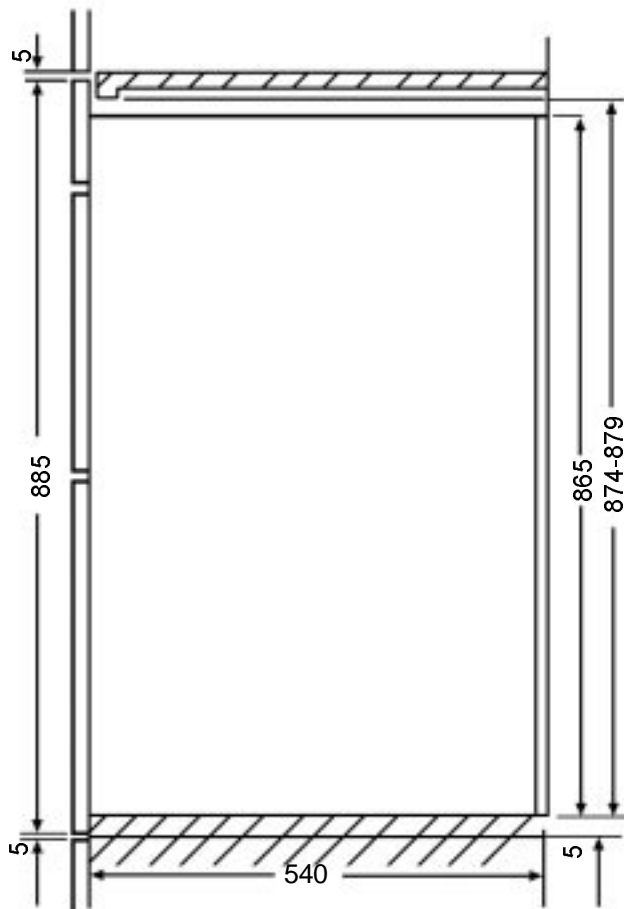
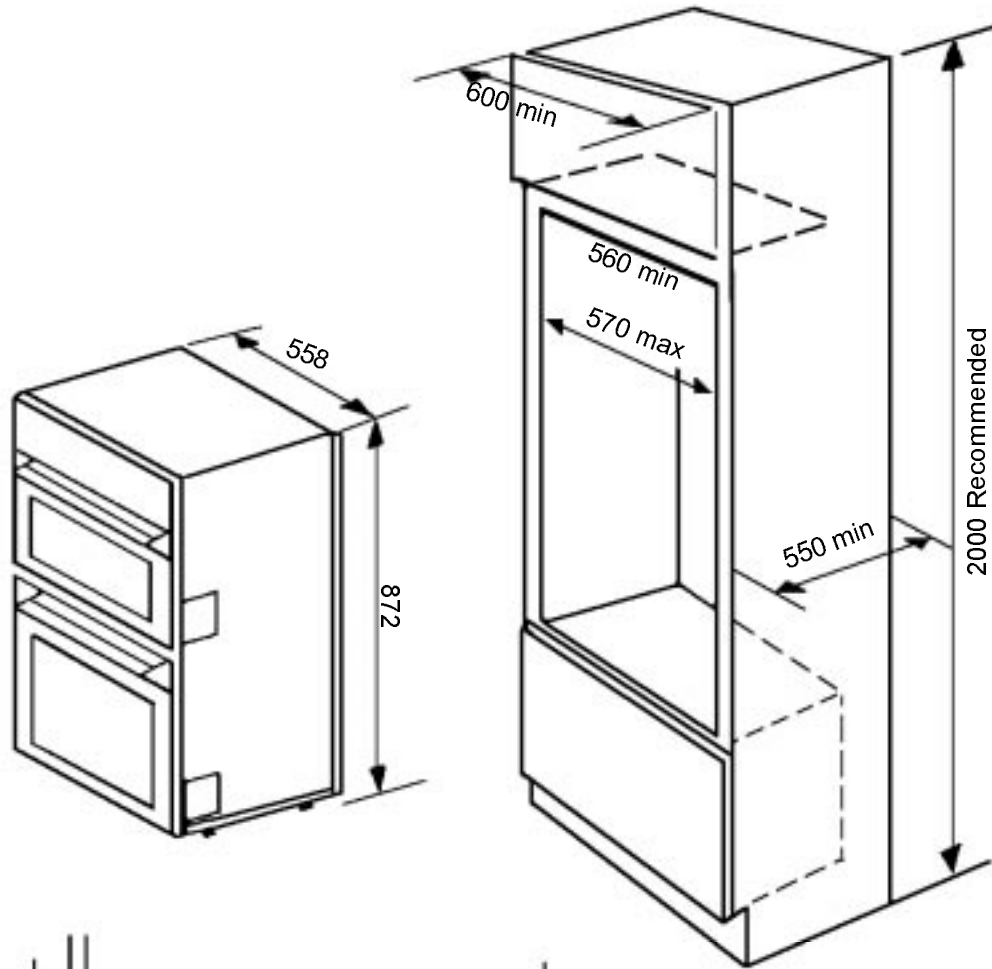

**Cross section
through
cabinet
showing oven
positioned**

Fig.2 Built In Installation

HOW TO FINISH UNPACKING

- Place packed cooker next to the cabinet in which it will be installed.
- Remove the cooker packing except for bottom tray which should be left in position until the cooker is ready to be fitted into its cabinet.
- Ensure the owner is given these operating instructions.

TOOLS REQUIRED

The following tools will be needed and it helps to assemble them before starting to install your oven:

A terminal screwdriver (3mm wide blade)
A pozidrive screwdriver
Pliers
Wirestrippers
Knife
Sidecutters
Adhesive Tape
Tape Measure

MAKE THE ELECTRICAL CONNECTIONS

Important: Switch off at mains, miniature circuit breaker and, if appropriate, remove fuse before commencing any electrical work.

PREPARING CABLE

We recommend you use a new length of cable to ensure your safety.

- Ensure you have the correct length of cable appropriate to the wiring method you are using. When fitting new cable allow sufficient cable for removal of the unit at a later date, should it be necessary.
- Score, but do not cut through, around the sheathing with a knife 100mm (4in) from each end of the cable and break through to the encased wires by bending the cable backwards and forwards to fatigue the sheathing.

- Carefully score down from each end of the cable sheathing along the length of the bare earth wire (if a cut was made along the length of the live or neutral wires, it might cut into their sheathing) to the cuts already made.
- Carefully prise open the sheathing at each end of the cable to expose the encased wiring.

TO REMOVE COVER OF MAINS TERMINAL

From the rear of the cooker, remove mains input terminal cover to gain access to terminal block.

- First remove retaining screw with pozidrive screwdriver. See Fig. 3.

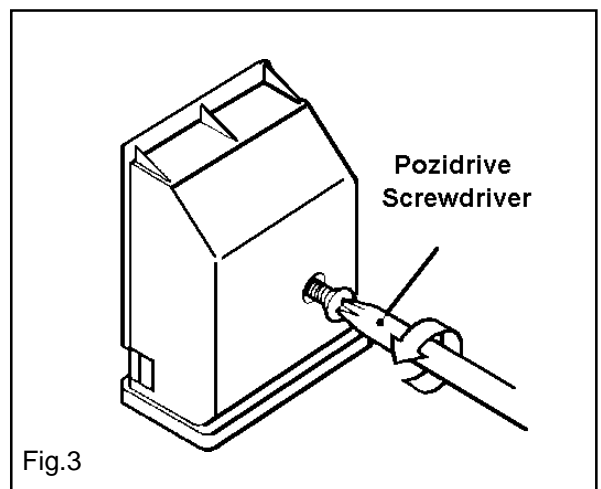

- Prise cover loose using screwdriver in position (1) then lever off with screwdriver in position (2) at either side. See Fig. 4.

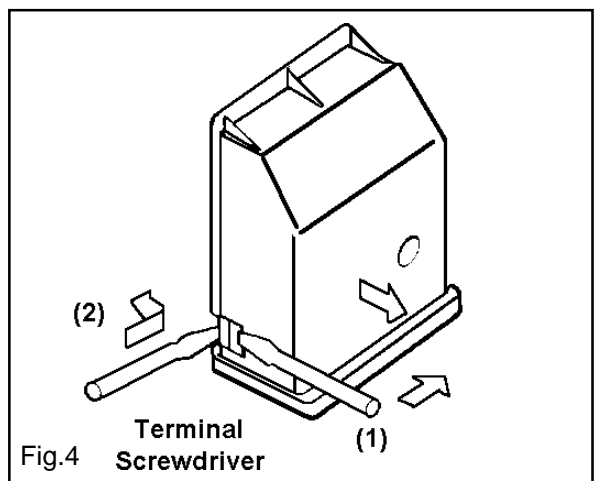

- Lift cover and remove screw from cable clamp. See Fig. 5.

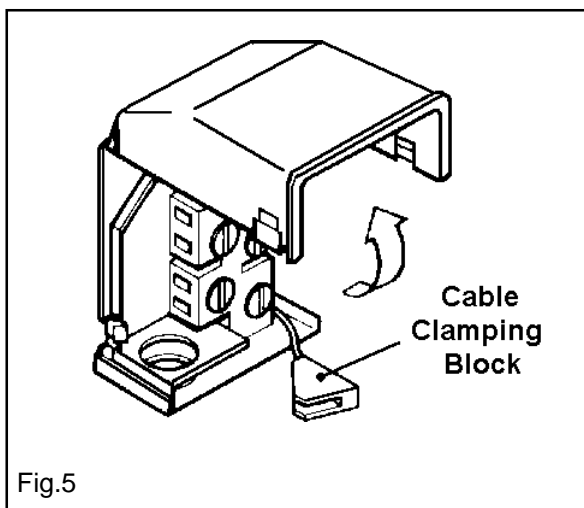

CONNECTING TO MAINS TERMINAL

Warning: This cooker must be earthed.

- Make connection as shown in Fig. 6 by proceeding as follows:-

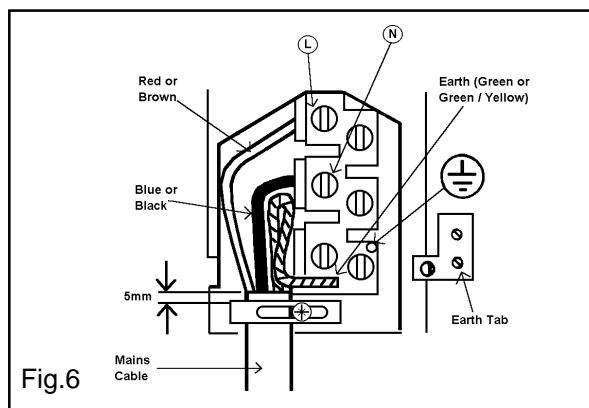

- Preform wires to the appropriate shape to suit fitting into the mains terminal block.
- Strip inner insulation on wires using wirestrippers.
- Twist the bared wires using pliers.
- Cut bared wires 10mm away from the end of the inner insulation. Where uninsulated Earth wires are used ensure they are suitably sheathed to leave 10mm bare wire to fit into the terminal.
- Clamp bare wires into the relevant terminal and check they are held by tugging each one in turn.

- Clamp the mains cable securely ensuring 5mm of the outer insulation is inside the terminal block and that the wires are not taught but not so slack as to cause any fouling. See Fig. 6.
- Place fuse/ miniature circuit breaker in circuit and switch on at mains.

CONNECTING TO A HOB OR COOKER POINT

WARNING: THIS COOKER MUST BE EARTHED.

- Either follow in general terms the instructions for connecting to the terminal block or refer to the hob suppliers installation instructions.

Feed the cable through the cabinet and arrange to route the cable away from the cooker which may become hot.

CHECKING ELECTRICAL CONNECTIONS

- Correct electrical connection can be confirmed when switching on the appliance as the electronic minute minder will be flashing.

NOTE: HOUSE CIRCUIT

Earth leakage and continuity tests must be carried out before the cooker is connected to the mains supply and re-checked after fitting.

FITTING INTO THE CABINET

IMPORTANT: Ensure that the oven is switched off at the wall before any further work is carried out.

- Using a tape measure establish the internal width of the cabinet. Refer to page 8 if greater than 565mm.
 - Position the cooker in front of the cabinet. See Fig. 7.
 - Take out all oven furniture before installation to reduce the weight you need to lift. The oven door should be taped up to keep it closed whilst lifting.
 - To place the cooker into the cabinetry follow the procedure below:
 - N.B. Two people will be required to carry out the lifting procedure.
- a) Each person should squat either side of the cooker.
 - b) Tilt the cooker so that your hands can support the underside of the cooker.
 - c) Keeping your back straight, raise the appliance to the cabinet by straightening at the knees.
 - d) Rest the rear underside of the cooker on the cabinet floor while your hands support the front.
 - e) The cooker can be pushed fully into the cabinet. Take care to avoid fouling the mains lead.
 - f) Ensure the cooker is central in the cabinet and level.
 - g) When the cooker is fully housed screw the stability screws (supplied with the cooker) into the side of the cabinet taking care not to distort the side trims (See Fig. 8). It is advisable to turn each screw alternately to avoid damaging the trims.
 - h) Switch on the cooker then refer to the operating instructions in the following pages.

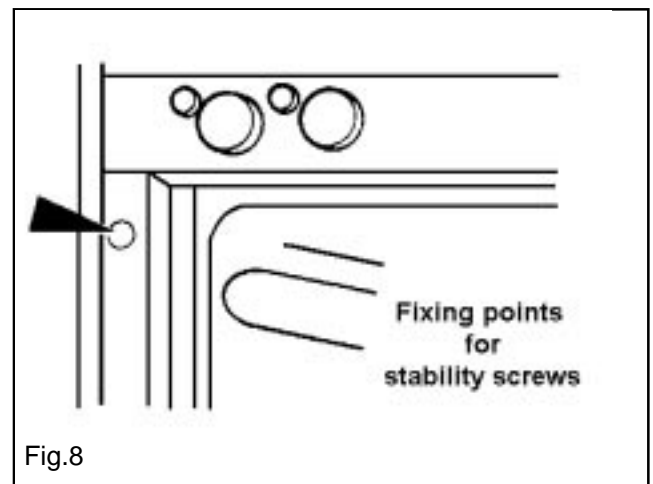
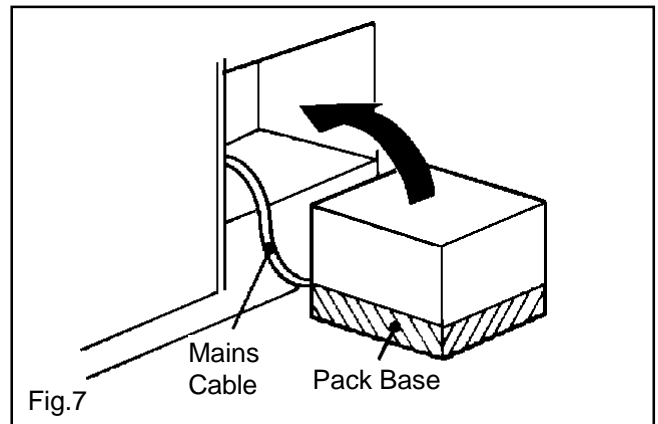

INTRODUCTION

WARNING: THIS COOKER MUST BE EARTHED

GETTING TO KNOW YOUR OVEN

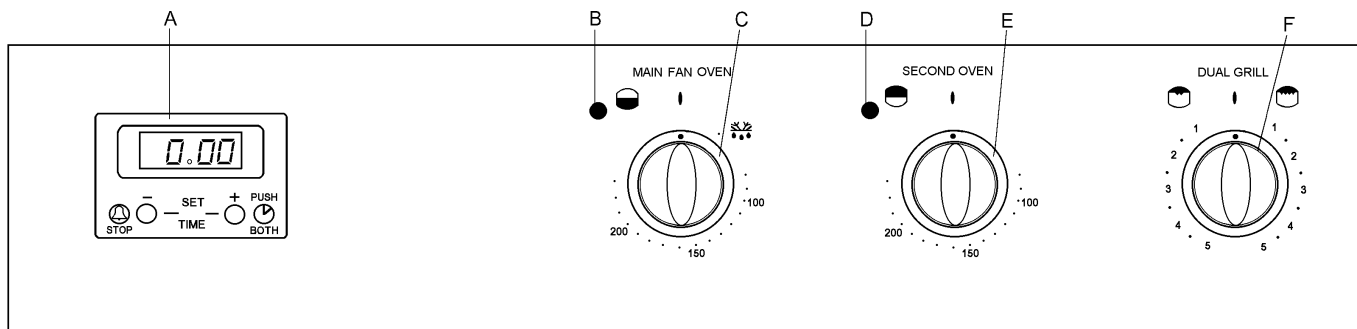

A - Oven Timer

B - Main Oven Indicator Neon

C - Main Oven Temperature Control

D - Second Oven Indicator Neon

E - Second Oven Temperature Control

F - Dual Grill Control

INTRODUCTION

RATING PLATE

Record the model, product and serial numbers of your cooker on the back cover of this instruction book. These numbers can be found on the lower front frame of the cooker upon opening the oven door.

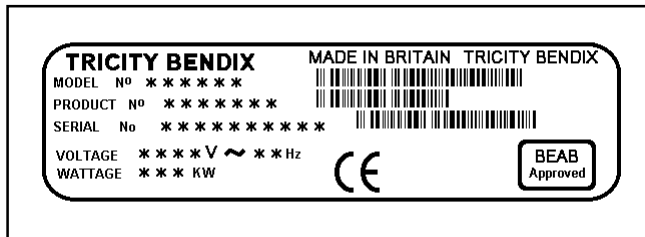

The cooker must be protected by a suitably rated fuse or circuit breaker. The rating of the cooker is given on the rating plate.

GENERAL NOTES ON USING THE OVENS

We suggest that you run the elements for 10-15 minutes at 220°C to burn off any residue from their surfaces.

The procedure should be repeated with the grill for approximately 5 - 10 minutes.

During this period an odour may be emitted, it is therefore advisable to open a window for ventilation.

ABOUT CONDENSATION AND STEAM

When food is heated it produces steam similar to a boiling kettle. The ovens are vented to allow some of this steam to escape. However, always stand back from the cooker when opening the oven door to allow any build up of steam or heat to release.

If the steam comes into contact with a cool surface on the outside of the cooker, e.g. a trim, it will condense and produce water droplets. This is quite normal and is not caused by a fault on the cooker.

To prevent discolouration, regularly wipe away condensation and also soilage from surfaces.

COOKWARE

Baking trays, oven dishes etc., should not be placed directly against the grid covering the fan at the back of the oven.

Do not use baking trays larger than 30cm x 35cm (12" x 14") as they will restrict the circulation of heat and may affect performance.

THE COOLING FAN FOR THE CONTROLS

The cooling fan comes on immediately when the grill is switched on and after a short time when the oven is in use. It runs on after the controls are switched off until the cooker has cooled. During the initial period the cooling fan may cycle ON and OFF, this is quite normal.

Do not switch off the cooker at its power point before the cooling fan has cooled the appliance down.

CONTROL PANEL INDICATOR NEONS

These lights indicate whether the ovens are switched ON. The neons also indicate when the set temperature has been reached.

If the neons do not operate as the instructions indicate the controls have been incorrectly set. Return all controls to zero and reset following the instructions for the required setting.

GRILL AND OVEN FURNITURE

The following items of grill and oven furniture have been supplied with the cooker.

1 grill pan



1 grill pan handle



1 grill pan grid

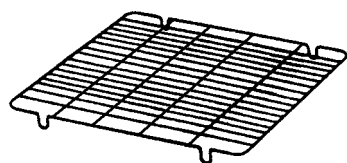

1 grill deflector

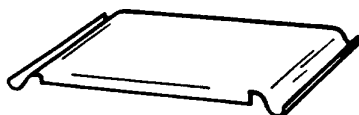

1 meat tin



1 cranked shelf
(for grilling
and second
oven cooking only)

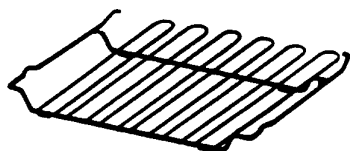

2 straight shelves
(for main oven
cooking)

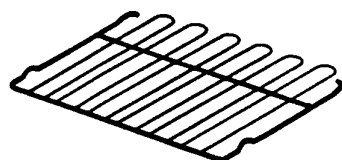

Scuffing of the Stayclean oven lining by the oven furniture pack may occur during transit.

These marks will disappear after the oven elements have been burnt off for the first time.

THE OVEN TIMER

- 1 = (-) DECREASE CONTROL & MINUTE MINDER SETTING BUTTON
- 2 = (+) INCREASE CONTROL
- (☹) COOKPOT SYMBOL
- (🕒) CLOCK SETTING SYMBOL
- (🔔) MINUTE MINDER SYMBOL

The electronic minute minder can indicate the time of day, operate as a minute minder and it can be used to time and switch off the main oven.

1. SET THE TIME OF DAY

When the electricity supply is first switched ON, the display will flash 0.00. See Fig. 1.

Press buttons (1) and (2) together. The display will momentarily read 88.88. See Fig. 2. Release buttons, 0.00 will appear in the display as Fig. 3. **Within 5 seconds** press button 2, 12.00 will show in the display as Fig. 4.

Within 5 seconds press and hold either button (1) to decrease or button (2) to increase the time until the correct time of day on the 24 hour clock is reached, e.g.14.30. See Fig. 5.

Note: The increase and decrease control buttons operate slowly at first, and then more rapidly. They should be pressed separately.

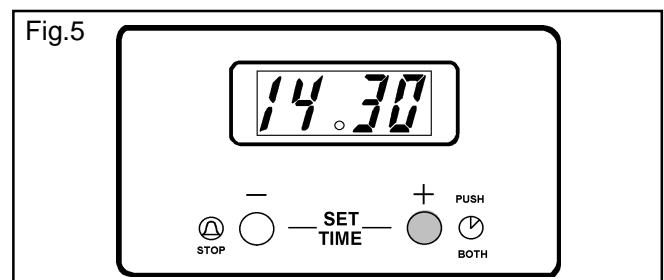
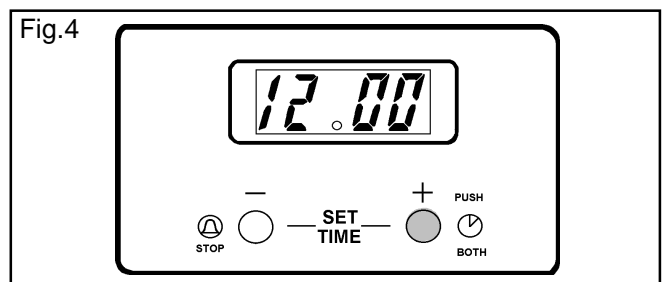
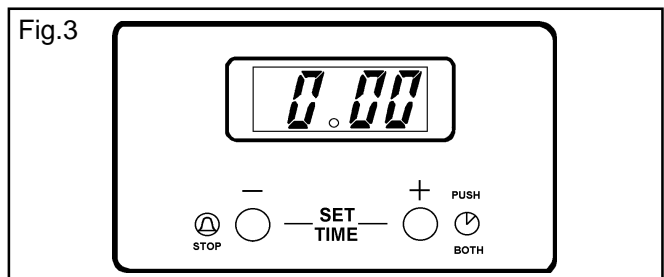
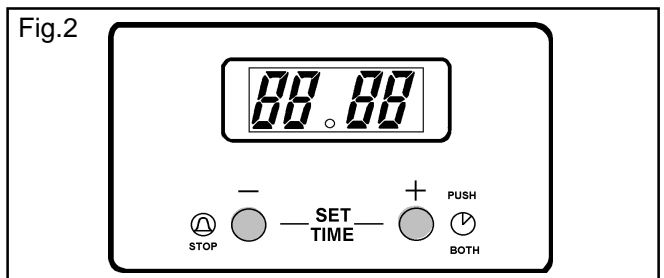
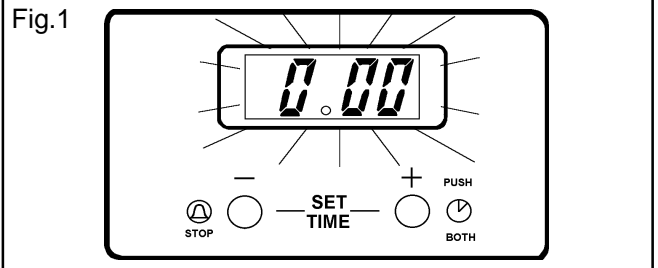
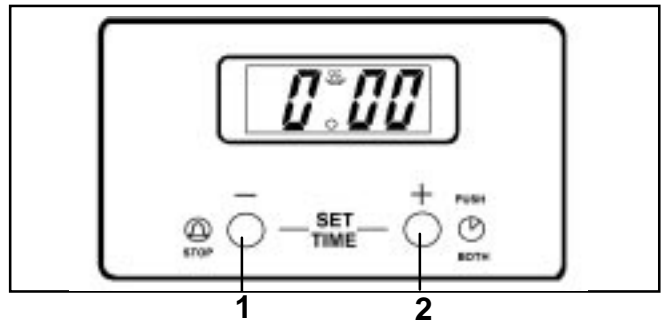

2. THE MINUTE MINDER

IMPORTANT

The minute minder can be used to time a set cooking period. At the end of the cook time the minute minder will automatically switch off the main oven if in use.

The minute minder gives an audible reminder at the end of any period of cooking up to 23 hours and 59 minutes.

To set press button (1) and the display will read 0:00, see Fig. 6.

Release button (1) and press and hold button (2). The display will count up in one minute intervals until the interval to be timed is reached e.g. 30 minutes, see Fig. 7. If necessary press and hold button (1) to achieve the correct time interval.

The minute minder will begin to count down once set. At the end of the timed period the minute minder will click, switching the main oven OFF if in use.

An audible signal will sound for up to 2 minutes. The second oven, if in use will remain ON. The cookpot symbol will flash and the time of day will show in the display. See Fig. 8.

To stop the sound press button (1). The display will stop flashing and show the time of day, e.g. 15.00. The cookpot symbol () will go out, see Fig. 9. If using the main oven it will come on again once button (1) has been depressed. The second oven will remain on. When cooking is complete remove food and turn OFF oven temperature control.

3. TO CANCEL THE MINUTE MINDER

Press and release button (1). Press and hold button 1 and the display will count down in one minute intervals to 0:00 See Fig 10. Release button (1). After a few seconds the cookpot symbol will flash and the time of day will show in the display. See Fig. 11.

If the main oven is in use this will switch OFF after a few seconds. The second oven if in use will remain ON.

To reset, press buttons (1) and (2) together. See Fig. 12.

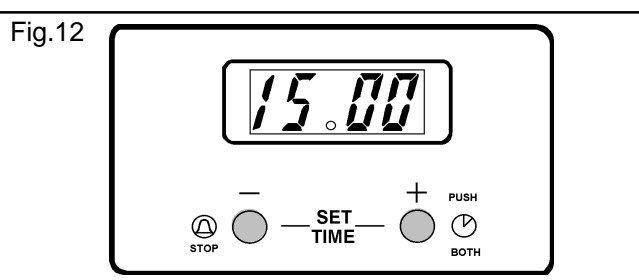
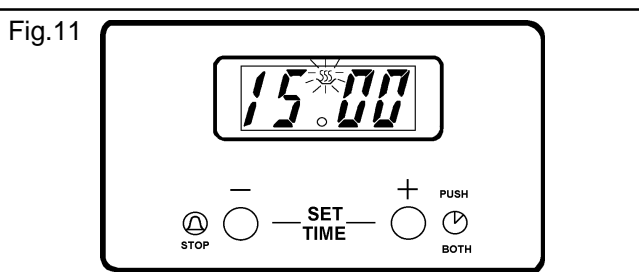
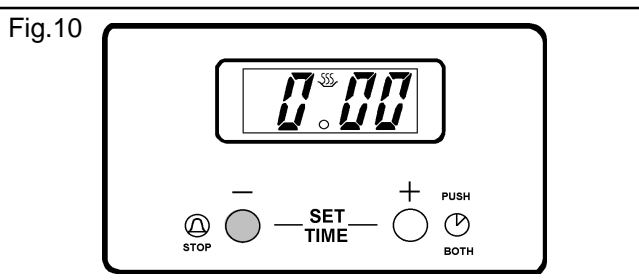
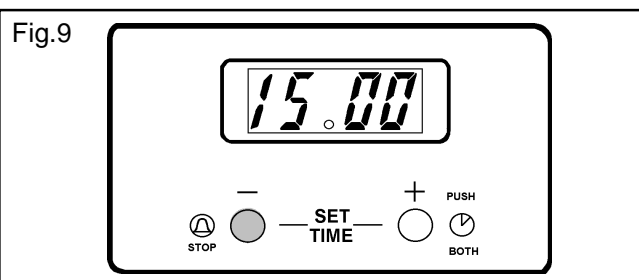
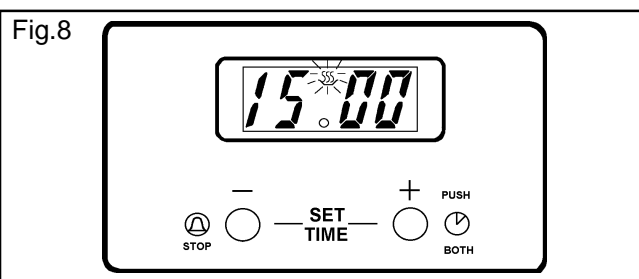
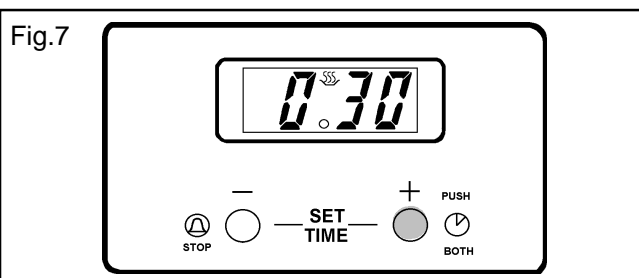
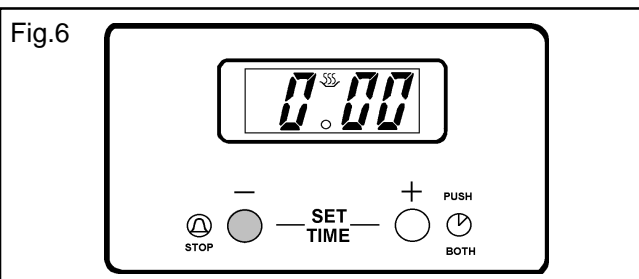

4. THINGS TO NOTE

1. The time of day must be set before the main oven will operate. There will be a few seconds delay before the oven switches on.
2. The minute minder function controls the main oven only and will switch the oven OFF at the end of a timed period. This function is useful if you want to begin cooking now and have the oven switch OFF automatically.
3. If you have used the minute minder to time food cooking in the main oven you will need to reset the timer by pushing both buttons before the oven can operate again.



USES OF THE DUAL GRILL

CAUTION - ACCESSIBLE PARTS MAY BECOME HOT WHEN THE GRILL IS IN USE. CHILDREN SHOULD BE KEPT AWAY.

The grill is a dual circuit grill which means that the whole area of the grill can be used or, for economy purposes the centre section only can be used when cooking smaller quantities of food.

SELECTING THE DUAL GRILL

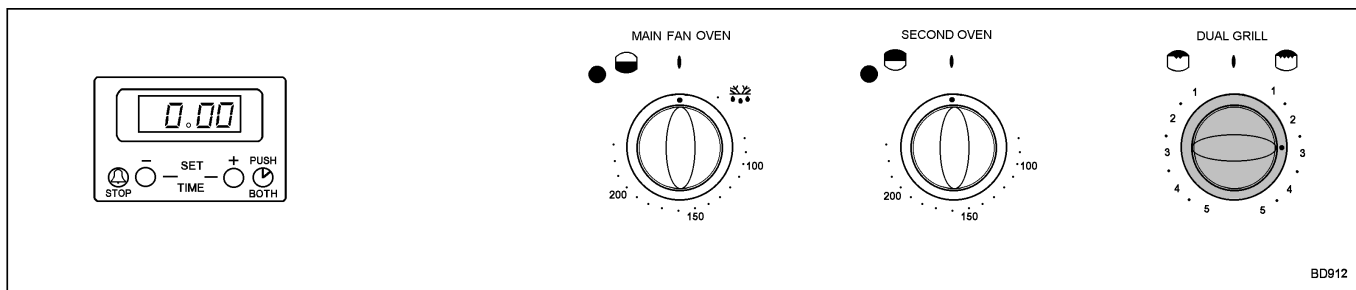

- Turn the grill control clockwise for full grill or anticlockwise for the centre section only.
- Ensure the second oven control is in the OFF position 'O'.

THINGS TO NOTE

THE GRILL DOOR MUST BE LEFT OPEN DURING GRILLING

1. The cooling fan for the controls will operate in conjunction with the grill.
2. The outer grill element may appear to glow slightly brighter than the inner element. This is quite normal.
3. The dual grill operates independently of the oven.

THE GRILL PAN AND HANDLE

The grill pan is supplied with a removable handle.

To insert the handle, press the button on the handle with the thumb and pivot the handle slightly upwards inserting the lip into the widest part of the bracket. Move the handle towards the left, lower into position and release the button.

Ensure the handle is positively located.

When removing the handle press the button on the handle with the thumb and pivot the handle slightly upwards and towards the right to remove from the bracket.

Ensure your hand is protected when removing the grill pan handle as the grill element can become very hot.

ALWAYS REMOVE THE GRILL PAN HANDLE DURING GRILLING

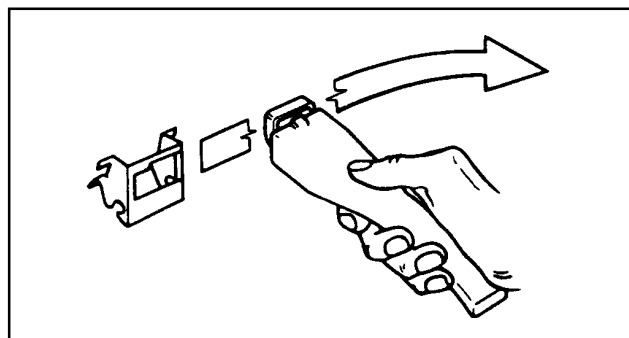

To correctly locate the grill pan on the shelf, ensure that the cut-out on the underside of the handle bracket locates over the front bar of the shelf.

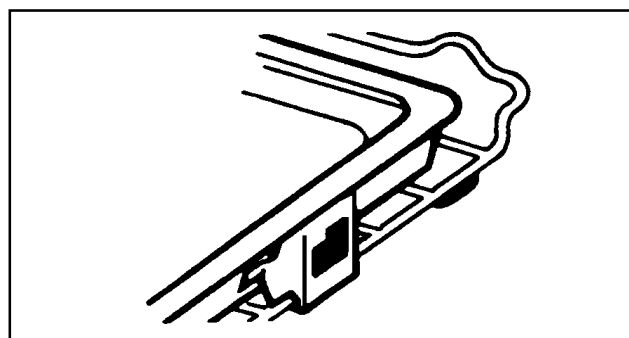

To check the progress of the food being grilled, the grill pan should be withdrawn on the shelf to attend to food during cooking.

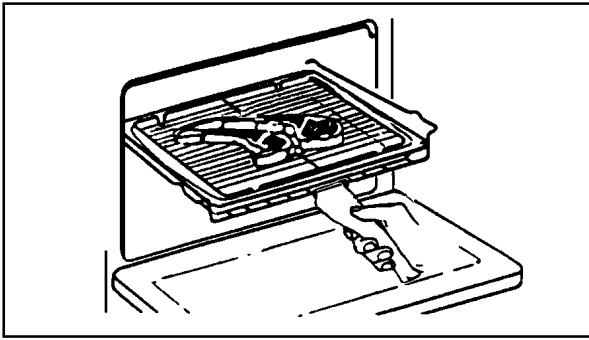

HINTS AND TIPS

- Most foods should be placed on the grid in the grill pan to allow maximum circulation of air to lift the food out of the fats and juices. Food such as fish, liver and kidneys may be placed directly on the grill pan base if preferred.

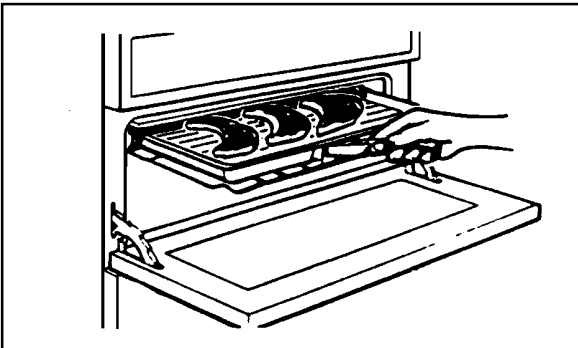

- Adjust the grid and grill pan runner position to allow for different thicknesses of food. Position the food close to the element for faster cooking and further away for more gentle cooking.

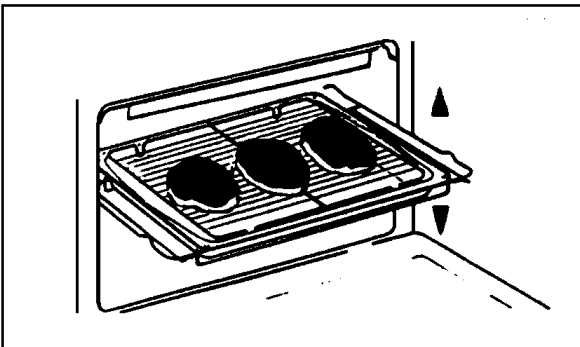

- Food should be thoroughly dried before grilling to minimise splashing. Brush lean meats and fish lightly with a little oil or melted butter to keep them moist during cooking.

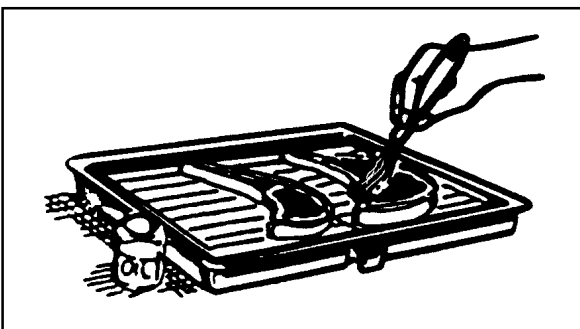

- Accompaniments such as tomatoes and mushrooms may be placed underneath the grid when grilling meats.

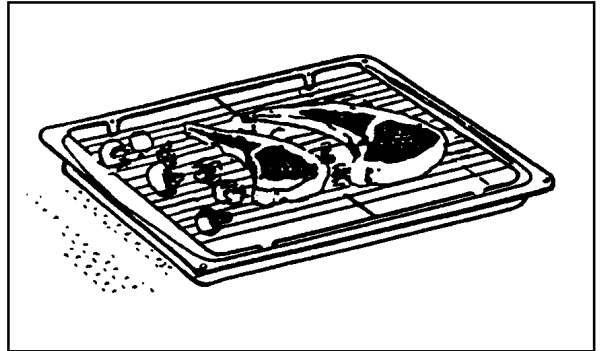

- When toasting bread, we suggest that the top runner position is used with the grid in its 'high' position.
- Preheat the grill on a full setting for a few minutes before sealing steaks or toasting. Adjust the heat setting and the shelf as necessary during cooking.
- The food should be turned over during cooking as required.

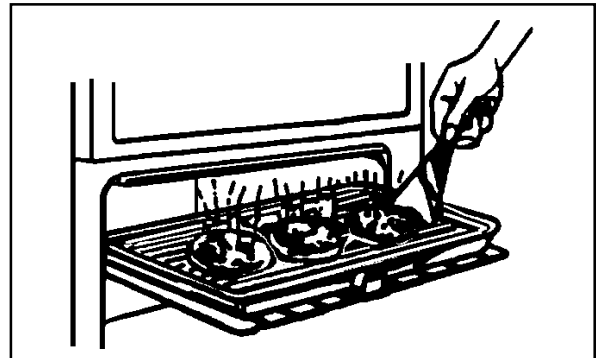

GRILLING CHART

FOOD	SHELF	GRILL TIME (mins in total)
Toast	2crk.	4-6
Bacon Rashers	2crk.	10
Beefburgers	2crk.	10-15
Chicken Joints	2crk.	30-40
Chops - Lamb	2crk.	15-20
Pork	2crk.	20-30
Fish - Whole Trout/Mackerel	2crk.	15-25
Fillets - Plaice/Cod	2crk.	15
Kebabs	2crk.	20-30
Kidneys - Lamb/Pig	2crk.	8-12
Sausages	2crk.	20-30
Steaks - Rare	2crk.	6-12
Medium	2crk.	12-16
Well Done	2crk.	14-20
Toasted Sandwiches	2crk.	3-4

crk. = Cranked Shelf

Shelf positions are counted from the bottom of the oven upwards.

The times quoted above are given as a guide and should be adjusted to suit personal taste.

The cranked shelf should be used for grilling and top oven cooking only.



USES OF THE SECOND OVEN

The second oven is the smaller of the two ovens. It is heated by elements in the top and bottom of the oven. It is designed for cooking smaller quantities of food. It gives especially good results if used to cook fruit cakes, sweet and savoury flans or quiche.

The second oven is also ideal for use as a warming compartment to warm dishes and keep food hot. Use a temperature setting of 80° - 100°C on the second oven temperature control.

SELECTING THE SECOND OVEN

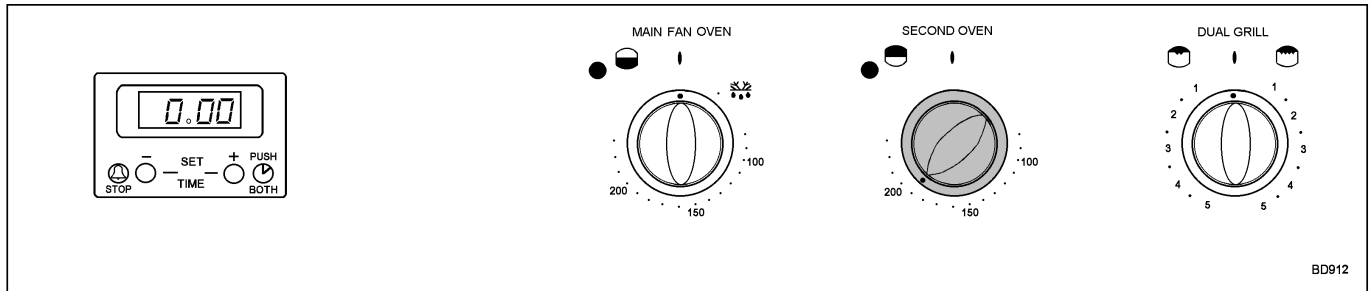

- Ensure the grill control is in the off, '0' position.
- Turn the second oven temperature control to the required setting.

THINGS TO NOTE

1. The second oven indicator neon will glow until the oven has reached the desired temperature and then go out. It will cycle ON and OFF periodically during cooking showing that the temperature is being maintained.
2. The cooling fan for the controls will operate, after a period of time.
3. Dishes, tins or trays should not be placed directly on the oven floor as it becomes very hot and damage will occur.

TO FIT THE TOP OVEN SHELF

The cranked shelf should be fitted with the straight rods uppermost on the frame and the forms towards the back of the oven. If not fitted correctly the anti-tilt and safety stop mechanism will be affected.

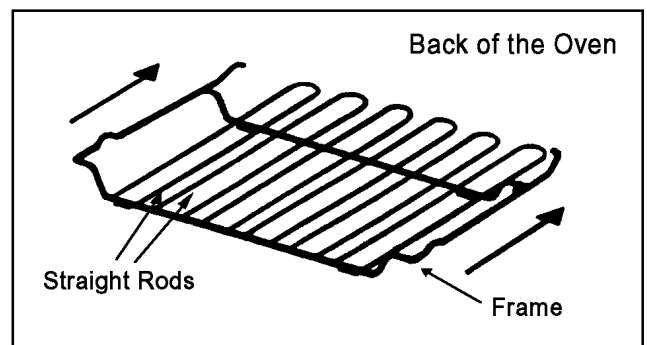

HINTS AND TIPS

- All cooking should be carried out on shelf positions one and two using a cranked shelf. When more space is required, for example when roasting or casseroles, a straight shelf from the main oven may be placed on the second oven base.

- There should always be at least 2.5cm (1") between the top of the food and the element. This gives best cooking results and allows room for rise in yeast mixtures, Yorkshire puddings etc. When cooking cakes, pastry, scones, bread etc., place the tins or baking trays centrally below the element.

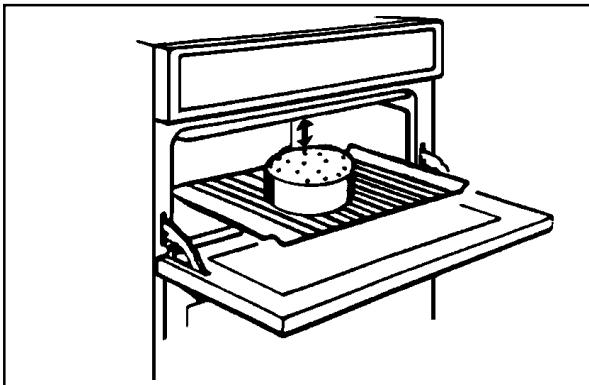

- Ensure that food is placed centrally on the shelf and there is sufficient room around the baking tray/dish to allow for maximum circulation.

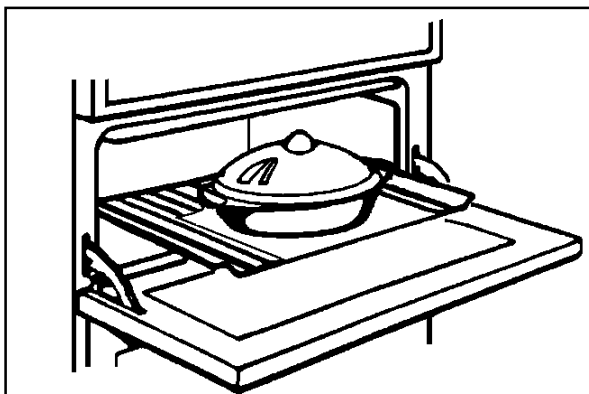

- Stand dishes on suitably sized baking trays to prevent spillage onto the oven base and to help reduce cleaning.
- The material and finish of the baking tray and dishes will affect the degree of base browning of the food. Enamelware, dark, heavy or non-stick utensils increase base browning. Shiny aluminium or polished steel trays reflect the heat away and give less base browning.
- DO NOT use the grill pan or meat tin as a baking tray as this will increase base browning of the food.
- Because of the smaller cooking space, lower temperatures and shorter cooking times are sometimes required. Be guided by the recommendations on page 27.
- For economy leave the door open for the shortest possible time, particularly when placing food into a pre-heated oven.



USES OF THE FAN OVEN

PREHEATING

The fan oven quickly reaches its temperature, so it is not usually necessary to preheat the oven. Without preheating however, you may find you need to add an extra 5-10 minutes on the recommended cooking times. For recipes needing high temperatures, e.g. bread, pastries, scones, soufflés, etc., best results are achieved if the oven is preheated first.

COOKING TEMPERATURES

Fan oven cooking generally requires lower temperatures than conventional cooking. Follow the temperatures recommended in the chart on page 27. As a guide reduce temperatures by about 20°C - 25°C for your own recipes.

BATCH BAKING

The fan oven cooks evenly on all shelf levels, especially useful when batch baking.

SELECTING THE FAN OVEN

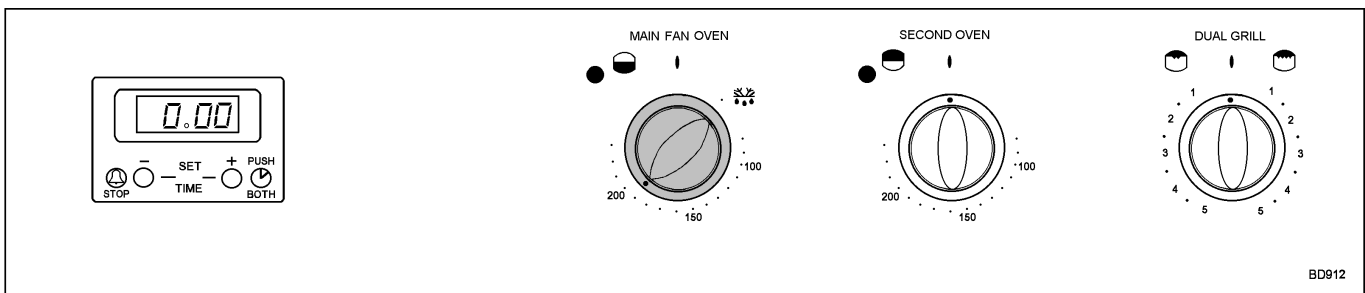

- Turn the main oven temperature control to the required setting.

THINGS TO NOTE

- 1) The main oven indicator neon will glow until the oven has reached the desired temperature and then go out. It will cycle ON and OFF periodically during cooking showing that the temperature is being maintained.
- 2) The oven fan will operate continually during cooking.
- 3) The cooling fan for the controls operates after a period of time.
- 4) The internal oven light will come on.

BD912

TO FIT THE MAIN OVEN SHELVES

The shelves should be fitted with the straight rods uppermost on the frame and the forms towards the back of the oven. If not fitted correctly the anti-tilt and safety stop mechanism will be affected. Only use straight shelves in the main oven.

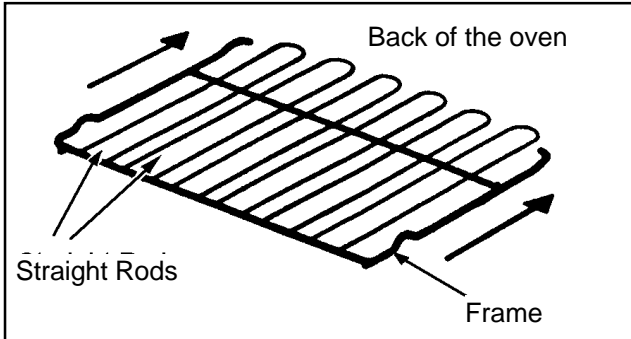

HINTS AND TIPS

- Arrange the shelves in the required positions before switching the oven ON. Shelves are numbered from the bottom upwards.

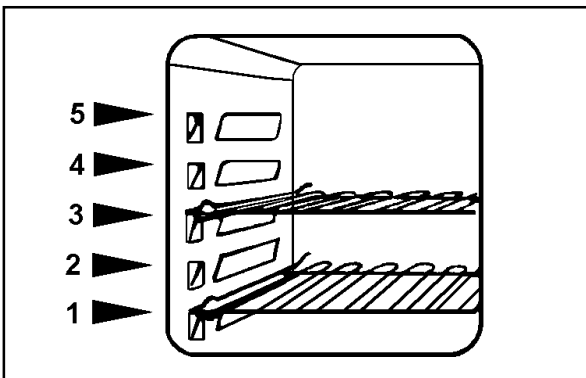

- When cooking more than one dish in the fan oven, place dishes centrally on different shelves rather than cluster several dishes on one shelf, this will allow the heat to circulate freely for the best cooking results.
- If it is unavoidable that several dishes are placed on the shelves, for your safety DO NOT withdraw the shelf when removing food or dishes from the oven.
- When batch baking one type of food, e.g. Victoria sandwich cakes, those of similar size will be cooked in the same time.

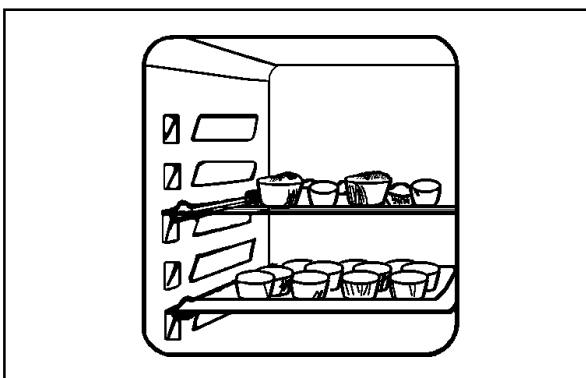

- Do not use the cranked shelf from the grill in the main oven.
- It is recommended that when baking larger quantities, the shelf positions should be evenly spaced to suit the load being cooked. A slight increase in cooking time may be necessary.
- DO NOT place baking trays directly on the oven floor as it interferes with the oven air circulation and can lead to base burning; use the lower shelf position. However, non critical dishes may be placed on the oven base when more space is required.

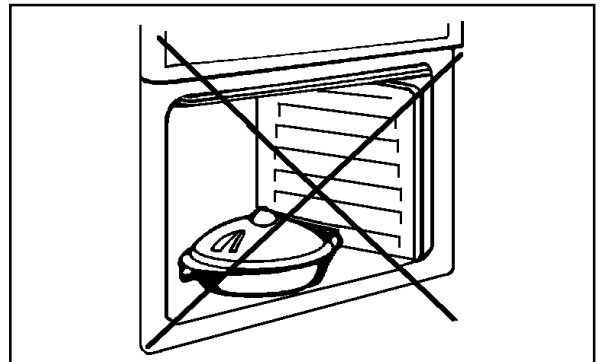

- The use of excessively high temperatures can cause uneven browning. It may be necessary to reduce temperatures slightly. Refer to the recommendations given in the oven cooking chart, see page 27.

OVEN COOKING CHART

The oven temperatures are intended as a guide only. It may be necessary to increase or decrease the temperatures by 10°C to suit individual preferences and requirements.

FOOD	FAN OVEN		TOP OVEN		
	SHELF POSITION	COOKING TEMP °C	SHELF POSITION	COOKING TEMP °C	APPROX COOK TIME (m)
Biscuits		180-190	1 crk.	170-190	10 - 20
Bread		200-220	1 crk.*	200-220	25 - 30
Bread rolls/buns	Shelf	200-220	1 crk.	200-220	15 - 20
Cakes:	Small & Queen	160-170	1 crk.	180-190	18 - 25
	Sponges	160-170	1 crk.	160-170	18 - 20
	Victoria Sandwich	160-170	1 crk.	160-170	18 - 25
	Madeira	140-150	1 crk.	140-150	1¼ - 1½h
	Rich Fruit	130-140	1 crk.	130-140	2¼ - 2½h
	Christmas	130-140	1 crk.	130-140	3 - 4½h
					depends on size
	Gingerbread	140-150	1 crk.	140-150	1¼ - 1½h
	Meringues	80-100	1 crk.	90-100	2½ - 3h
	Flapjack	170-180	1 crk.	170-180	25 - 30
	Shortbread	130-140	1 crk.	140-150	45 - 65
Casseroles:	Beef/lamb	140-160	1 crk.*	140-160	2½ - 3h
	Chicken	180-190	1 crk.*	180-190	1¼ - 1½h
Convenience Foods		Follow manufacturer's instructions			
Fish	that oven	170-190	1 crk.	170-190	20 - 30
Fish Pie (Potato Topped)		190-200	1 crk.*	190-200	20 - 25
Fruit Pies, Crumbles		190-200	1 crk.	190-200	40 - 50
Milk Puddings	shelves are	130-140	1 crk.	140-150	1½ - 2h
Pasta, Lasagne etc.		190-200	1 crk.	170-180	40 - 45
Pastry:	Choux	190-200	1 crk.	180-190	30 - 35
	Eclairs, Profiteroles	170-180	1 crk.	170-180	20 - 30
	Flaky/Puff Pies	210-220	1 crk.*	210-220	25 - 40
Shortcrust	Mince Pies	190-200	1 crk.	190-200	15 - 20
	Meat Pies	190-210	1 crk.*	190-210	25 - 35
	Quiche, Tarts, Flans	180-210	1 crk.	180-200	25 - 45
Patés and Terrines		150-160	1 crk.	150-160	1-1½h
Roasting Meat, Poultry	when more	160-180	1 crk.*	160-180	see roasting chart
Scones		210-220	1 crk.	220-230	8 - 10
Shepherd's Pie		190-200	1 crk.*	190-200	30 - 40
Soufflés	than one is	170-180	1 crk.	170-180	20 - 30
Vegetables:	Baked Jacket Potatoes	180-190	1 crk.	180-190	1-1½h
	Roast Potatoes	180-190	1 crk.	180-190	1-1½h
	Stuffed Marrow	180-190	1 crk.	180-190	30 - 35
	Stuffed Tomatoes	180-190	1 crk.	180-190	15 - 20
Yorkshire Puddings:	Large	210-220	1 crk.	200-210	25 - 40
	Individual	200-210	1 crk.	200-210	15 - 25

crk. = cranked shelf

* or on a straight shelf on the oven base.

Note : Shelf positions are counted from the bottom of the oven
Do not use the cranked shelf from the grill in the main oven.

ROASTING CHART

ROASTING CHART		
INTERNAL TEMPERATURES - Rare : 50-60°C; Medium : 60-70°C; Well :70-80°C		
MEAT	SECOND/FAN OVEN	COOKING TIME
Beef	160-180°C	20-35 min per ½kg/1lb and 20-35 min over
Beef, boned	160-180°C	20-35 min per ½kg/1lb and 25-35 min over
Mutton and Lamb	160-180°C	25-35 min per ½kg/1lb and 25-35 min over
Pork and Veal	160-180°C	30-40 min per ½kg/1lb and 30-40 min over
Ham	160-180°C	30-40 min per ½kg/1lb and 30-40 min over
Chicken	160-180°C	15-20 min per ½kg/1lb and 20 min over
Turkey and Goose	160-180°C	15-20 min per ½kg/1lb up to 3½kg/7lb then 10 min per ½kg/1lb
Duck	160-180°C	25-35 min per ½kg/1lb and 25-30 min over
Pheasant	160-180°C	35-40 min per ½kg/1lb and 35-40 min over
Rabbit	160-180°C	20 min per ½kg/1lb and 20 min over
Potatoes with meat	160-180°C	according to size
Potatoes without meat	180-190°C	according to size

The roasting temperatures and times given in the chart should be adequate for most joints, but slight adjustments may be required to allow for personal requirements and the shape and texture of the meat. However, lower temperatures and longer cooking times are recommended for less tender cuts or larger joints.

Wrap joints in foil if preferred, for extra browning uncover for the last 30 - 60 min. cooking time.

DEFROSTING

USES OF DEFROST FEATURE

This main oven function defrosts most foods faster than more conventional methods. It is particularly suitable for delicate frozen foods which are to be served cold, e.g. cream filled gateaux, cakes covered with icings or frostings, cheesecakes, biscuits, scones, etc.

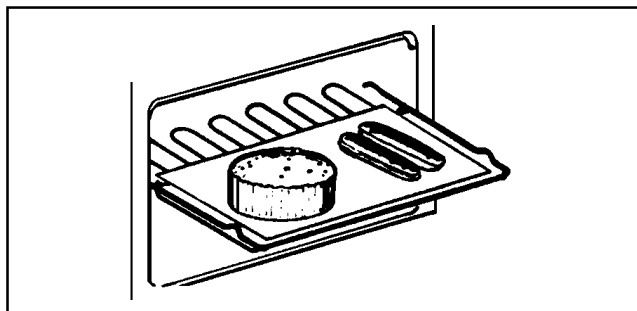

It is preferable to thaw fish, meat and poultry slowly in the fridge. However, this process can be accelerated by using the defrost function.

Small or thin fish fillets, frozen peeled prawns, cubed or minced meat, liver, thin chops, steaks etc., can be thawed in 1 - 2 hours.

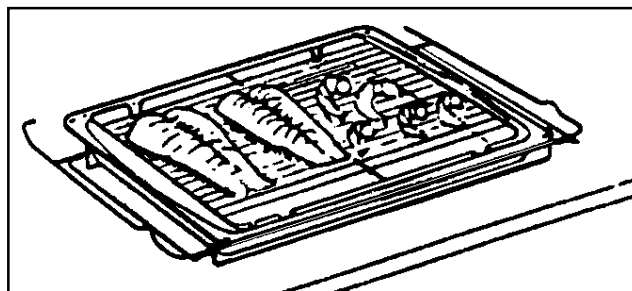

A 1kg/2¼lb oven ready chicken will be thawed in approximately 5 hours. Remove the giblets as soon as possible during the thawing process.

Joints of meat up to 2kg/4½lb in weight can be thawed using the defrost function.

ALL JOINTS OF MEAT AND POULTRY MUST BE THAWED THOROUGHLY BEFORE COOKING.

ALWAYS COOK THOROUGHLY IMMEDIATELY AFTER THAWING.

SELECTING DEFROST

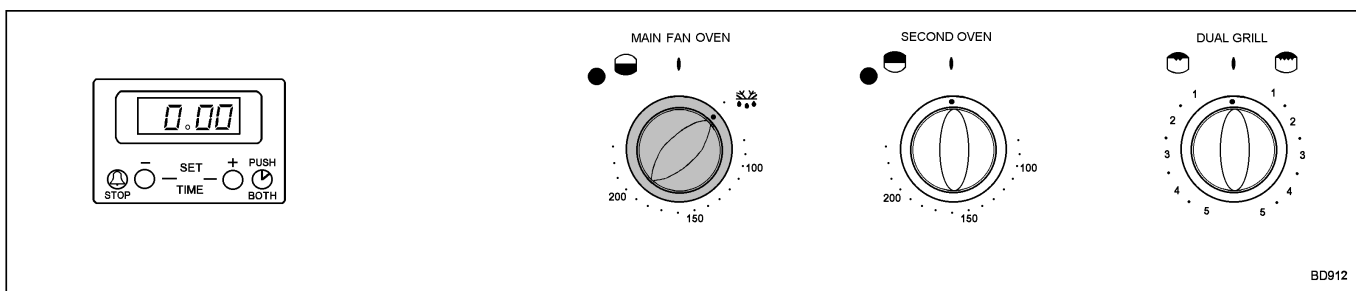

- Turn the main oven temperature control to the defrost setting ().

THINGS TO NOTE

1. Care must always be taken when handling foods in the home. Always follow the basic rules of food hygiene to prevent bacterial growth and cross contamination when defrosting, preparing, cooking, cooling and freezing foods.
2. The oven fan and internal oven light will come on.
3. The cooling fan does not operate.

HINTS AND TIPS

- Place the frozen food in a single layer where possible and turn it over half way through the defrosting process.

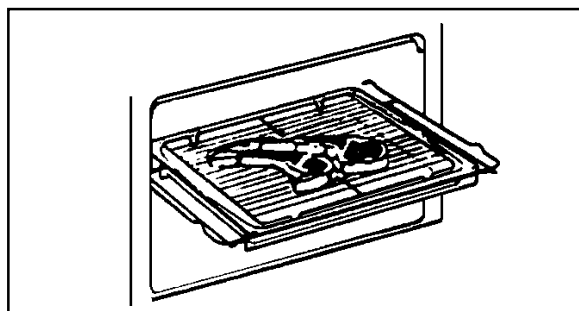

- The actual speed of defrosting is influenced by room temperature. On warm days defrosting will be faster than on cooler days.
- DO NOT leave food at room temperature once it is defrosted. Cook raw food immediately or store cooked food in the fridge.

HELPFUL HINTS WHEN BUYING AND PREPARING FOOD

Care must be taken when handling foods in the home. Always follow the basic rules of food hygiene to prevent bacterial and microbial growth and cross contamination when preparing, reheating, cooking, cooling, defrosting and freezing foods:-

1. Always ensure food you purchase is of good quality and in prime condition. Shop at a reliable source and buy the 'freshest' looking package - avoid shop-worn labels or produce covered in dust.
2. Avoid buying chilled or frozen products if you cannot store them straight away. The use of an insulated container when shopping is advisable.
3. Buy and consume foods prior to the 'Sell by' or 'Best Before' date.
4. When you arrive home, place perishable foods in the refrigerator or freezer immediately. Ensure they are well covered to prevent them drying out and to prevent any possible cross contamination with bacteria from raw to cooked foods.
5. Follow the cooking instructions on packets of prepacked and cook chill foods, but be prepared to adjust cooking time and temperatures to suit your particular oven. For example, the fan oven generally requires 20-25°C lower temperature than conventional ovens.
6. Always ensure that cook chill foods are thoroughly re-heated until they are piping hot throughout.
7. It is preferable to defrost frozen foods slowly in the refrigerator. Alternatively, a microwave cooker or the Defrost function on your oven may be used.
8. Always cook defrosted foods immediately after thawing. Thawed food should never be refrozen.
9. Joints of meat and poultry should be thoroughly defrosted before cooking.

10. Cook meat thoroughly - use a meat thermometer if preferred, which penetrates the joint to check that the centre temperature has reached the required temperature (see table below).

MEAT	TEMPERATURES
Beef	Rare - 60°C Medium - 70°C Well Done - 80°C
Pork	Well Done - 80°C
Lamb	Medium - 70°C Well Done - 80°C

11. If not eaten straightaway after cooking, food should be cooled as quickly as possible (within one hour) and then refrigerated or frozen as required. (**Do not** put hot food into a Refrigerator or Freezer).
12. In the kitchen keep work tops, chopping boards and utensils clean with hot soapy water between preparation stages. Ideally, keep one chopping board for raw meat and another for other foods. Keep your dish cloths and tea towels clean.

CARE AND CLEANING

BEFORE CLEANING ALWAYS ALLOW THE COOLING FAN TO COOL THE COOKER DOWN BEFORE SWITCHING OFF AT THE ELECTRICITY SUPPLY

CLEANING MATERIALS

Before using any cleaning materials on your cooker, check that they are suitable and that their use is recommended by the manufacturer.

Cleaners that contain bleach should NOT be used as they may dull the surface finishes. Harsh abrasives should also be avoided.

CLEANING THE OUTSIDE OF THE COOKER

DO NOT use abrasive cleaning materials or scourers on the outside of the cooker, as some of the finishes are painted and damage may occur. Regularly wipe over the control panel, oven doors and cooker sides using a soft cloth and liquid detergent.

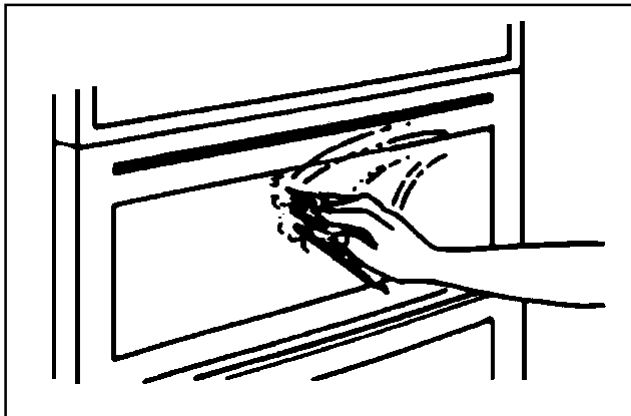

DO NOT ATTEMPT TO REMOVE ANY OF THE CONTROL KNOBS FROM THE PANEL AS THIS MAY CAUSE DAMAGE AND IS A SAFETY HAZARD.

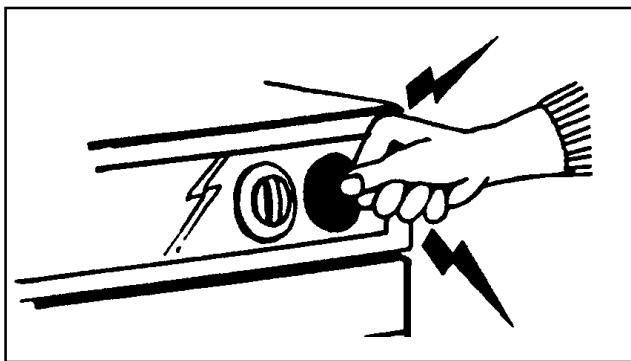

CLEANING INSIDE THE OVENS

The Stayclean surface inside the main oven should not be cleaned manually. See page 32 "Care of Stayclean Surfaces".

The vitreous enamel oven base can be cleaned using normal oven cleaners or aerosol oven cleaners with care. Ensure that the manufacturers instructions are followed and that all parts are well rinsed afterwards.

Aerosol cleaners must not be used on Stayclean surfaces and must not come into contact with elements or the door seal as this may cause damage.

CLEANING THE GRILL DEFLECTOR, MEAT TIN, GRILL PAN, GRILL PAN GRID AND OVEN SHELVES

All parts, except the grill pan handle can be washed in the dishwasher. Alternatively, soak them in hot soapy water if they are heavily soiled. They will then clean more easily.

The grill pan, meat tin and grill deflector may be cleaned using a soap impregnated steel wool pad. The grill pan grid and oven shelves should be cleaned using hot soapy water. Soaking first in soapy water will make cleaning easier.

CLEANING BETWEEN THE OUTER AND INNER DOOR GLASS

The outer door glass is removable for cleaning.

TO REMOVE THE OUTER GLASS

1. Open the oven door slightly to gain access to the two cross head screws on the top of the oven door.
2. Loosen the two screws using a Pozidrive screwdriver.
3. Hold the door glass securely with one hand, before removing the screws completely with the other hand.
4. Using both hands, gently tilt the top of the door glass towards you. Lift slightly to disengage the locators from the two bottom brackets. As you do this the door will close.

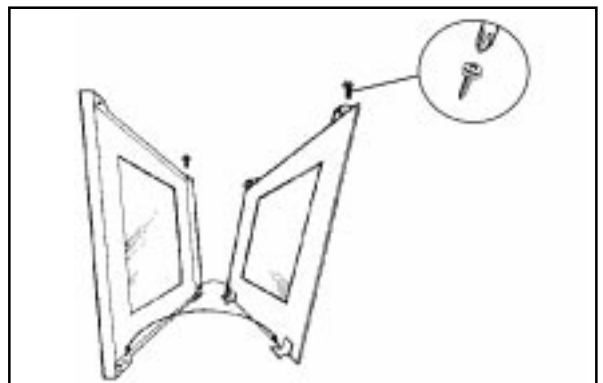

- Clean the outer and inner glass using hot soapy water or Hob Brite. DO NOT try to clean the aluminium foil which is inside the door. The foil is there to help keep the door cool, if it is damaged it will not work. Ensure that all parts are well rinsed and thoroughly dry before attempting to replace the outer door glass.

TO REPLACE THE OUTER GLASS

- Holding the oven glass with both hands, gently place the locators into the holes of the brackets at the bottom of the oven door.
- Push the top of the oven glass towards the oven door ensuring the screw location holes line up.
- Hold the glass in place at the top of the door. Still holding the glass, carefully open the door and insert the cross head screw into the location holes. Give the screws one turn to ensure the glass is secure.
- Tighten the screws positively with the Pozidrive screwdriver before closing the oven door.

DO NOT attempt to use the oven without the glass being in place.

CLEANING INSIDE THE OVEN AND GRILL COMPARTMENTS

The vitreous enamel coating in the oven and grill cavities can be cleaned using normal oven cleaners or aerosol oven cleaners with care. Ensure that the manufacturers instructions are followed and that all parts are well rinsed afterwards.

CARE OF STAYCLEAN SURFACES

Stayclean surfaces destroy splashes of food and fats when the oven temperature is raised to around 220°C.

It is a good idea to run the oven for an hour or two per week to ensure continued good performance from the Stayclean finish.

HINTS AND TIPS

- Manual cleaning of Stayclean is not recommended. Damage will occur if oven sprays or abrasives of any kind are used.

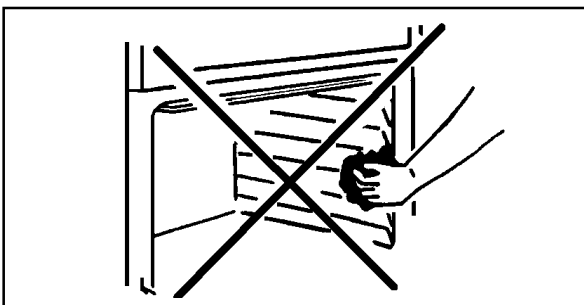

- Slight discolouration and polishing of the Stayclean surface may occur in time. This does not affect the Stayclean properties in any way.
- A good time to allow the oven to run on is after the weekly roast. After removing the roast, turn the oven up to 220°C and allow to run for an hour or so. It is important not to allow a build-up of soilage as this can prevent the Stayclean from working.
- Follow the recommendations below to keep oven soilage to a minimum.
- Cook at the recommended temperatures. Higher temperatures during roasting will increase soilage. Try cooking at lower temperatures for an increased length of time, you will save energy and often the joint is more tender.
- Use minimal, if any, extra oil or fat when roasting meat; potatoes only require brushing with fat before cooking. Extra fat in the oven during roasting will increase splashing and soilage.
- It is not necessary to add water to the meat tin when roasting. The water and the fat juices from the joint create excessive splattering during cooking even at normal temperatures as well as causing condensation.
- Covering joints during cooking will also prevent splashing onto the interior surfaces; removing the covering for the last 20-30 minutes will allow extra browning, if required. Some large joints and turkeys especially benefit by this method of cooking, allowing the joint to cook through before the outside is overbrowned.

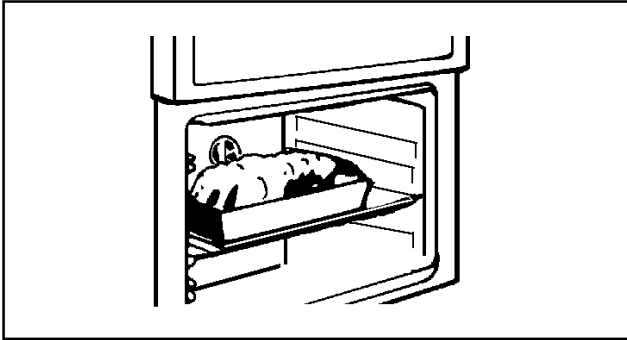

REPLACING THE OVEN LIGHT BULB

The type of bulb required is a 300C 25 watt small Edison Screw. Part number 572 491 5431-00/1. (Available through Tricity Bendix service centres).

CAUTION: DISCONNECT THE COOKER FROM THE ELECTRICITY SUPPLY BEFORE REPLACING THE BULB.

Open door and remove the shelves to enable easy access to the oven light assembly. Insert a flat blade screwdriver between the oven side and the glass which covers the bulb.

Support the glass with your hand and prise out sufficiently to release the glass cover. Unscrew the bulb in an anti-clockwise direction until it is possible to remove the bulb with ease.

Fit the new bulb by turning in a clockwise direction until it is secure. Ensuring the indent to the flange is pointing to the rear of the oven, replace the glass by pushing it firmly into the hole to cover the bulb assembly.

Replace the shelves. Restore the electricity supply and adjust the time of day and clock, as necessary.

SOMETHING NOT WORKING?

Before calling an Engineer please carry out the following checks, you may be able to solve the problem without the expense of an Engineer.

If our Service Engineer finds that the problem is listed below you will be charged for the call whether or not the cooker is under guarantee.

The grill, oven and timer do not work.

- * Check that the cooker has been wired in and is switched on at the wall.
- * Check that the main cooker fuse is working.

If you have checked the above:

- * Switch OFF cooker at the wall and allow the appliance to cool for a couple of hours. Switch ON again. The cooker should now be working normally.

The grill works but the main oven does not:

- * Check that the grill control is in the OFF position.
- * Switch OFF at the wall to allow the oven to cool. Check that the oven is now working normally.

The second oven and grill work but the main oven does not.

- * Switch OFF at the wall to allow the oven to cool. Check that the oven is now working normally.

The clock and minute minder do not work.

- * Check that the operating instructions for the timer are being closely followed.

The grill does not work or cuts out after being used for a long period of time.

- * Leave the oven to cool for a couple of hours. Check that the grill is now operating normally. Ensure that the door is left open during grilling.
- * If the cooling fan fails the grill will not work. contact the Customer Service Centre.

The oven temperature is too high or low.

- * Check that the recommended temperatures are being used (see page 27). Be prepared to adjust up or down by 10°C to achieve the results you want.
- * Care should be taken if using an oven thermometer to check oven temperatures as they may be inaccurate.

The following factors should be considered.

- * Ensure you purchase an accurate good quality instrument.
- * Ovens will cycle about a set temperature and will not be constant.

If the oven is not cooking evenly.

- * Check that the cooker is correctly installed and that it is level.
- * Check that the recommended temperatures and shelf positions are being used.

The oven light fails to illuminate.

- * Refer to page 33 ' Replacing the Oven Light Bulb.'

The oven fan is noisy.

- * Check that the oven is level.
- * Check that bakeware and shelves are not vibrating in contact with the back panel in the oven.

HELP US TO HELP YOU

Please determine your type of enquiry before writing or telephoning.

SERVICE

It is a recommendation by the manufacturer that annual servicing of the product is done by the manufacturers approved service organisation.

In the event of your appliance requiring service, or if you wish to purchase spare parts please contact your local Tricity Bendix Service Force Centre by telephoning:

0990 929929

The address of your local Service Force Centre is detailed on the following pages headed Tricity Bendix Service Force.

Before calling out an engineer, please ensure you have read the details under the heading 'Something Not Working?' and have the model number and purchase date to hand.

Please note that all enquiries concerning service should be addressed to your local Service Centre.

CUSTOMER CARE DEPARTMENT

For general enquiries concerning your Tricity Bendix cooker or for further information on Tricity Bendix products, you are invited to contact our Customer Care Department by letter or telephone as follows:

Customer Care Department
Tricity Bendix
PO Box 47
Newbury
Berkshire
RG14 5XL

Tel: (01635) 525542

TRICITY BENDIX SERVICE FORCE

To contact your local Tricity Bendix Service Centre telephone **0990 929929**

CHANNEL ISLANDS		<p>ORKNEY (M65) Corsie Domestics 7 King Street Kirkwall Orkney KW15</p>	NORTH EAST		
GUERNSEY	Guernsey Electricity PO Box 4 Vale, Guernsey Channel Islands	<p>SHETLAND Tait Electronic Systems Ltd. Holmsgarth Road Lerwick Shetland ZE1 0PW</p>	GATESHEAD (M39)	Unit 356a Dukesway Court Dukesway Team Valley Gateshead NE11 0BH	
JERSEY	Jersey Electricity Company PO Box 45 Queens Road St Helier Jersey Channel Islands JE4 8NY	<p>(OWN SALES)</p> <p>SHETLAND Bolts Shetland Ltd 26 North Road Lerwick Shetland ZE1 0PE</p>	GRIMSBY (M42)	Unit 2 Cromwell Road Grimsby South Humberside DN31 2BN	
SCOTLAND		<p>WHALSAY Leask Electrical Harlsdale Symbister, Whalsay Shetland ZE2 9AA</p>	HULL (M41)	Unit 1 Boulevard Industrial Estate Hull HU3 4AY	
SCOTLAND		NORTHERN IRELAND		LEEDS (M37)	64-66 Cross Gates Road Leeds LS15 7NN
ABERDEEN (M05)	8 Cornhill Arcade Cornhill Drive Aberdeen AB2 5UT	WALES		NEWTON AYCLIFFE (M45)	Unit 16 Gurney Way Aycliffe Ind Estate Newton Aycliffe DL5 6UJ
AUCHTERMUCHY (M03)	33A Burnside Auchtermuchy Fife KY14 7AJ	BELFAST (M27)	Owenmore House Kilwee Industrial Estate Upper Dunmury Lane Belfast BT17 0HD	SHEFFIELD (M38)	Pennine House Roman Ridge Ind. Roman Ridge Road Sheffield S9 1GB
BLANTYRE (M07)	Unit 5 Block 2 Auchenraith Ind Estate Rosendale Way Blantyre G72 0NJ	WALES		NORTH WEST	
DUMFRIES (M01)	93 Irish Street Dumfries Scotland DG1 2PQ	CARDIFF (M28)	Guardian Industrial Estate Clydesmuir Road Tremorfa, Cardiff CF2 2QS	BIRKENHEAD (M11)	1 Kelvin Park Dock Road Birkenhead L41 1LT
DUNOON (M67)	Briar Hill 7 Hill Street, Dunoon Argyll PA23 7AL	CLYWD (M14)	Unit 6-7 Coed - Parc Abergele Road Rhuddlan Clwyd Wales LL18 5UG	CARLISLE (M10)	Unit 8 South John Street Carlisle CA2 5AJ
GLASGOW (M04)	20 Cunningham Road Clyde Estate Rutherglen, Glasgow, G73 1PP	DYFED (M77)	Maes Y Coen High Mead Llanybydder Dyfed SA40 9UL	ISLE OF MAN (M64)	South Quay Ind Estate Douglas Isle of Man
INVERNESS (M06)	Unit 3B Smithton Indust. Est. Smithton Inverness IV1 AJ	HAVERFORDWEST (M75)	Cromlech Lodge Amerlston Haverfordwest SA62 5DS	LIVERPOOL (M15)	Unit 1 Honeys Green Precinct Honeys Green Lane Liverpool L12 9JH
ISLE OF ARRAN (OWN SALES)	Arran Domestics Unit 4 The Douglas Centre Brodict Isle of Arran KA27 8AJ	OSWESTRY (M17)	Plas Ffynnon Warehouse Middleton Road Oswestry SY11 2PP	MANCHESTER (M09)	Unit 30, Oakhill Trading Estate Devonshire Road Worsley Manchester M28 3PT
ISLE OF BARRA (OWN SALES)	J Zerfah 244 Bruernish Isle of Barra Western Islands HS9 5QY	WALES		PRESTON (M13)	Unit 250 Dawson Place Walton Summit Bamber Bridge Preston Lancashire PR5 8AL
ISLE OF BUTE (M66)	Walker Engineering Glenmhor Upper Serpentine Road Rothesay Isle of Bute PA20 9EH	WALES		STOCKPORT (M16)	Unit 20 Haigh Park Haigh Avenue Stockport SK4 1QR
ISLE OF LEWIS (M69)	ND Macleod 16 James Street Stornoway Isle of Lewis PA87 2QW	WALES			
KELSO (M08)	2-8 Wood Market Kelso Borders TD5 7AX	WALES			

To contact your local Tricity Bendix Service Centre telephone **0990 929929**

MIDLANDS

BIRMINGHAM (M18)	66 Birch Road East, Wyrley Road Industrial Estate Witton Birmingham B6 7DB
BOURNE (M44)	Manning Road Ind Estate Pinfold Road Bourne PE10 9HT
BRIDGNORTH (M72)	1 Underhill Street Bridgnorth Salop WV16 4BB
GLOUCESTER (M23)	101 Rycroft Street Gloucester GL1 4NB
HEREFORD (M31)	Unit 3 Bank Buildings Cattle Market Hereford HE4 9HX
HIGHAM FERRERS (M51)	30 High Street Higham Ferrers Northants NN10 8BB
ILKESTON (M43)	Unit 2 Furnace Road Ilkeston DE7 5EP
LEICESTER (M22)	Unit 7 Oaks Industrial Estate Coventry Road Narborough Leicestershire LE9 5GF
LINCOLN (M40)	Unit 8 Stonefield Park Clifton Street Lincoln LN5 8AA
NEWCASTLE UNDER LYME (M12)	18-21 Croft Road Brampton Industrial Estate Newcastle under Lyme Staffordshire ST5 0TW
NUNEATON (M21)	19 Ptarmigan Place Townsend Drive Nuneaton CV11 6RX
REDDITCH (M20)	13 Thornhill Road North Moons Moat Redditch Worcestershire B98 9ND
TAMWORTH (M19)	Unit 3 Sterling Park Claymore Tamworth B77 5DO
WORCESTER (M73)	Unit 1 Northbrook Close Gregorys Mill Ind Estate Worcester WR3 8BP

LONDON & EAST ANGLIA

CHELMSFORD (M47)	Hanbury Road Widford Ind Estate Chelmsford Essex CM12 3AE
COLINDALE (M53)	Unit 14 Capitol Park Capitol Way Colindale London NW9 0EQ
ENFIELD (M49)	284 Alma Road Enfield London EN3 7BB
GRAVESEND (M57)	Unit B4, Imperial Business Estate Gravesend Kent DA11 0DL
HARPENDEN (M46)	Unit 4 Riverside Estate Coldharbour Lane Harpenden AL5 4UN
LETCHWORTH (M50)	16-17 Woodside Ind Est. Works Road Letchworth Herts SG6 1LA
MAIDENHEAD (M60)	Reform Road Maidenhead Berkshire SL6 8BY
MOLESEY (M61)	10 Island Farm Avenue West Molesey Surrey KT8 2UZ
NEWBURY (M24)	PO Box 5627 Newbury Berkshire RG14 5GF
IPSWICH (M48)	Unit 2B Elton Park Business Centre Hadleigh Road Ipswich IP2 0DD
NORWICH (M52)	2b Trafalgar Street Norwich NR1 3HN
SUNBURY (M63)	Unit 1a The Summit Hanworth Road Hanworth Ind Estate Sunbury on Thames TW16 5D
SYDENHAM (M62)	Unit 6 Metro Centre Kangley Bridge Road Sydenham SE26
WEST DRAYTON (M76)	2 / 4 Royal Lane Yiewsley West Drayton Middlesex UB7 8DL

SOUTH EAST

ASHFORD (M58)	Unit 2 Bridge Road Business Estate Bridge Road Ashford Kent TN2 1BB
FLEET (M59)	Unit 1 Redfields Industrial Estate Church Crookham Fleet Hampshire GU13 0RD
HAYWARDS HEATH (M55)	21-25 Bridge Road Haywards Heath Sussex RH16 1UA
TONBRIDGE (M56)	Unit 30 Deacon Trading Estate Morley Road Tonbridge Kent TN9 1RA

SOUTH WEST

BARNSTAPLE (M30)	P.O. Box 12 Barnstaple North Devon EX31 2YB
BOURNEMOUTH (M26)	63-65 Curzon Road Bournemouth Dorset BH1 4PW
BRIDGEWATER (M35)	6 Hamp Industrial Estate Bridgewater Somerset TA6 3NT
BRISTOL (M25)	11 Eldon Way Eldonwall Trading Bristol Avon BS4 3QQ
EMSWORTH (M33)	266 Main Road Southbourne Emsworth PO10 8JL
ISLE OF WIGHT (M34)	Unit 8 Enterprise Court Ryde Business Park Ryde Isle of Wight PO33 1DB
NEWTON ABBOT (M29)	Unit 2 Zealley Industrial Estate Kingsteignton Newton Abbot S. Devon TQ12 3TD
PLYMOUTH (M32)	16 Faraday Mill Cattedown Plymouth PL4 0ST
REDRUTH (M36)	Unit 7D Pool Industrial Estate Wilson Way, Redruth, Cornwall TR15 3QW

GUARANTEE CONDITIONS

Standard guarantee conditions

We, Tricity Bendix, undertake that if within 12 months of the date of the purchase this Tricity Bendix appliance or any part thereof is proved to be defective by reason only of faulty workmanship or materials, we will, at our option repair or replace the same FREE OF CHARGE for labour, materials or carriage on condition that:

- The appliance has been correctly installed and used only on the electricity supply stated on the rating plate.
- The appliance has been used for normal domestic purposes only, and in accordance with the manufacturer's instructions.
- The appliance has not been serviced, maintained, repaired, taken apart or tampered with by any person not authorised by us.
- All service work under this guarantee must be undertaken by a Tricity Bendix service centre.
- Any appliance or defective part replaced shall become the Company's property.
- This guarantee is in addition to your statutory and other legal rights.

Home visits are made between **8.30am** and **5.30pm** Monday to Friday. Visits may be available outside these hours in which case a **premium** will be charged.

Exclusions

This guarantee does not cover:

- Damage or calls resulting from transportation, improper use or neglect, the replacement of any light bulbs or removable parts of glass or plastic.
- Costs incurred for calls to put right an appliance which is improperly installed or calls to appliances outside the United Kingdom.
- Appliances found to be in use within a commercial environment, plus those which are subject to rental agreements.
- Products of Tricity Bendix manufacture which are not marketed by Tricity Bendix.

European Guarantee

If you should move to another country within Europe then your guarantee moves with you to your new home subject to the following qualifications:

- The guarantee starts from the date you first purchased your product.
- The guarantee is for the same period and to the same extent for labour and parts as exists in the new country of use for this brand or range of products.
- This guarantee relates to you and cannot be transferred to another user.
- Your new home is within the European Community (EC) or European Free Trade Area.
- The product is installed and used in accordance with our instructions and is only used domestically, i.e. a normal household.
- The product is installed taking into account regulations in your new country.

Before you move please contact your nearest Customer Care centre, listed below, to give them details of your new home. They will then ensure that the local Service Organisation is aware of your move and able to look after you and your appliances.

France	Senlis	+33 (0)3 44 62 28 28
Germany	Nürnberg	+49 (0)911 323 2600
Italy	Pordenone	+39 (0)1678 47053
Sweden	Stockholm	+46 (0)20 78 77 50
UK	Newbury	+44 (0)1635 525 542

RATING PLATE REFERENCE

MAKE AND MODEL NO.	PRODUCT NO.	SERIAL NO.	DATE OF PURCHASE

IMPORTANT NOTICE

In line with our continuing policy of research and development, we reserve the right to alter models and specifications without prior notice.

This handbook is accurate at the date of printing, but will be superseded and should be disregarded if specifications or appearance are changed.



TRICITY BENDIX, PO BOX 47, NEWBURY, BERKSHIRE, RG14 5XL
TELEPHONE (01635) 525542

MODEL NO.
BD 912/2



PART NO.
311399004

1998

Free Manuals Download Website

<http://myh66.com>

<http://usermanuals.us>

<http://www.somanuals.com>

<http://www.4manuals.cc>

<http://www.manual-lib.com>

<http://www.404manual.com>

<http://www.luxmanual.com>

<http://aubethermostatmanual.com>

Golf course search by state

<http://golfingnear.com>

Email search by domain

<http://emailbydomain.com>

Auto manuals search

<http://auto.somanuals.com>

TV manuals search

<http://tv.somanuals.com>