

TRICITY BENDIX

Better Products. Better Value.



900 mm Built In Oven

OPERATING AND INSTALLATION INSTRUCTIONS

MODEL NO.
BD 921/BD 931

TECHNICAL DETAILS

MODEL NO. BD 921

Voltage:	230/240 Volts AC 50 Hz
Wattage:	5.3/5.8 kW
Height:	885 mm
Width:	595 mm
Depth:	545 mm (excluding handles and knobs)
Weight:	53kg

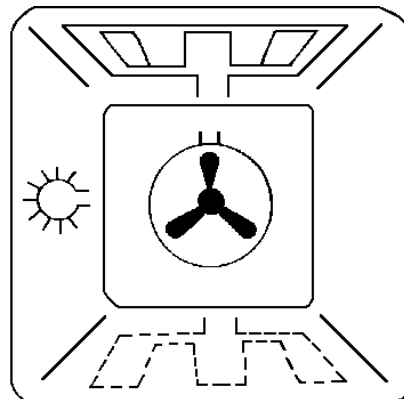
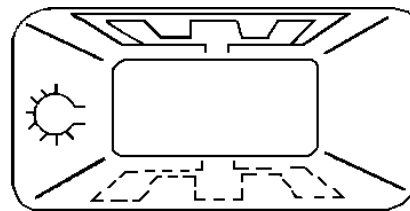

MODEL NO. BD 931

Voltage:	230/240 Volts AC 50 Hz
Wattage:	5.3/5.8 kW
Height:	885 mm
Width:	595 mm
Depth:	545 mm (excluding handles and knobs)
Weight:	53kg

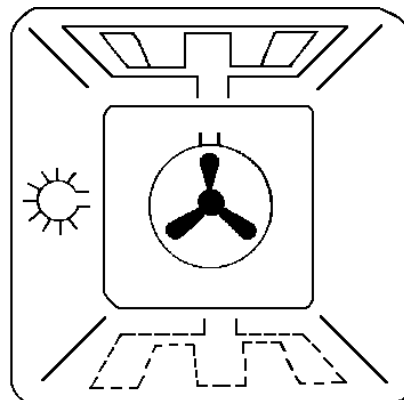
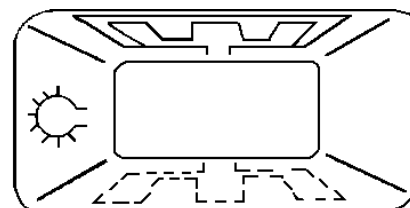

This appliance complies with: European Council Directive 73/23/EEC.
EMC Directive 89/336/EEC.
CE Marking Directive 93/68/EEC.

CONTENTS

Please follow these instructions step by step to install and operate your oven safely and easily.

Technical Details	2
Contents	3
Preface	5
Safety	6
Before Installation	6
During Operation	6
After Use	7
General	7
Installation Instructions	8
Things You Need to Know	8
Warnings	8
Things to Note	8
Getting Things Ready	8
Choice of Electrical Connection	8
Preparing Cabinet for Fitting Oven	8
Recommended Cabinet Dimensions	9
How to Finish Unpacking	10
Tools Required	10
Making the Electrical Connections	10
Preparing Cable	10
To Remove Cover of Mains Terminal	10
Connecting to the Mains Terminal	11
Connecting to a Hob or Cooker Point	11
Checking Electrical Connections	11
Fitting Into The Cabinet	12
Introduction	13
Getting to Know Your Oven (BD 921)	13
Getting to Know Your Oven (BD 931)	14
Rating Plate	15
General Notes on Using The Ovens	15
When First Switching On	15
About Condensation and Steam	15
Cookware	15
The Trivet	15
The Shelf Positions	15
Push to Turn Controls (BD 931 only)	16
The Cooling Fan for the Controls	16
Control Panel Indicator Neons	16
Grill and Oven Furniture	16
The Grill	17
Uses of the Dual Grill	17
Selecting the Dual Grill	17
Things to Note	17
The Grill Pan and Handle	18
Hints and Tips	18
Grilling Chart	19
The Second Oven	20
Uses of the Second Oven	20
Selecting the Second Oven	20
Things To Note	20
To Fit the Top Oven Shelf	21
Hints and Tips	21
Second Oven Cooking Chart	21

CONTENTS

The Main Fan Oven	22
Uses of the Fan Oven	22
Selecting the Fan Oven	22
Things to Note	23
To Fit the Main Oven Shelves	23
Hints and Tips	23
Defrost Feature	24
Uses of Defrost Feature	24
Selecting Defrost	24
Things to Note	24
Hints and Tips	25
The Conventional Oven	26
Uses of the Conventional Oven	26
Selecting the Conventional Oven	26
Things to Note	26
Hints and Tips	27
The Zoned Oven	28
Uses of the Zoned Oven	28
Selecting the Zoned Oven	28
Things to Note	28
Hints and Tips	29
Oven Cooking Chart	30
Thermal Grilling	31
Uses of Thermal Grilling	31
Selecting Thermal Grilling	31
Things to Note	31
Hints and Tips	32
Thermal Grilling Chart	33
Oven Clean Feature	34
Uses of Oven Clean Feature	34
Selecting Oven Clean	34
Things to Note	34
Hints and Tips	35
How to Use the Electronic Timer (BD 921)	36
How to Use the Electronic Timer (BD 931)	39
Helpful Hints when Buying and Preparing Food	43
Care and Cleaning	44
Cleaning Materials	44
Cleaning the Outside of the Cooker	44
Cleaning Between the Outer and Inner Door Glass	44
Cleaning Inside the Ovens	45
Cleaning the Oven Shelves and Grill/Oven Furniture	45
Care of Stayclean Surfaces	45
Hints and Tips	45
Cooking to Reduce Soilage	45
Replacing the Oven Light Bulb	46
Something Not Working?	47
Service and Spare Parts	48
Customer Service Centres	49
Guarantee Conditions	53

PREFACE

Dear Customer,

Thank you for buying a Tricity Bendix built-in oven. With our 80 years experience in developing and manufacturing the very best in U.K. cookers, you can be assured that you have purchased a hard working, reliable, quality cooker.

In addition Tricity Bendix cookers comply with British Standard safety and performance requirements. They have been approved by BEAB (British Electrotechnical Approvals Board) and are covered by a 12 month parts and labour guarantee.

In order that you get the best from your new Tricity Bendix cooker, the following instructions have been prepared. **PLEASE MAKE SURE YOU READ THEM CAREFULLY.** Particular attention should be paid to cooking times and temperatures which may differ from your previous cooker.

It is most important that this instruction book should be retained with the cooker for future reference. Should the cooker be sold, or transferred to another owner, or should you move house and leave the cooker, always ensure that the book remains with the cooker so that the new owner can be acquainted with the functioning of the cooker and the relevant warnings.

Please read the whole instruction book before using the cooker ensuring you follow the recommendations given.



SAFETY

THESE WARNINGS ARE PROVIDED IN THE INTERESTS OF YOUR SAFETY. ENSURE THAT YOU UNDERSTAND THEM ALL BEFORE INSTALLING OR USING THE COOKER.

PLEASE
READ
CAREFULLY

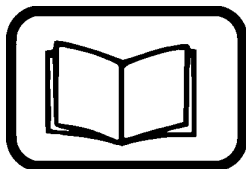

BEFORE INSTALLATION



This cooker is heavy and care **must** be taken when moving it.



Ensure that all packaging, both inside and outside the cooker has been removed before the cooker is used.



Do not try to move the cooker by pulling the door handles. Refer to installation instructions.



The cooker must be installed according to the instructions supplied. Any electrical installation work **must** be undertaken by a qualified electrician/competent person.

It is dangerous to alter the specifications or modify the cooker in any way.



After installation, please dispose of the packaging with due regard to safety and the environment.

DURING OPERATION



Do not use this cooker if it is in contact with water. **Never** operate it with wet hands.



This cooker is designed to be operated by adults and children under supervision. Young children **must not** be allowed to tamper with the controls or play near or with the cooker.

Caution accessible parts especially around the grill area may become hot when the cooker is in use. Children should be **kept away** until it has cooled.



Take **great care** when heating fats and oils as they will ignite if they become too hot.

This cooker has been designed for cooking edible foodstuffs only, and **must not** be used for any other purposes.



Never place plastic or any other material which may melt in or on the oven.



Ensure cooking utensils are large enough to contain foods to prevent spillages and boil overs.



Take care to follow the recommendations given for tending the food when grilling. Use the handle provided in the recommended way (see page 18).



Do not leave the handle in position when grilling as it will become hot.



Always use oven gloves to remove and replace food in the oven. Similarly always use oven gloves to remove and replace the grill pan handle when grilling. Recommendations given on page 18.



Ensure that you support the grill pan when it is in the withdrawn or partially withdrawn position.

Ensure that all vents are left unobstructed to ensure ventilation of the oven cavity.



You must ensure that the grill control is in the 'OFF' position when the timer control has been set for automatic cooking.

Ensure that the anti-tilt shelves are put in place correctly. Refer to instructions on pages 21 and 23.



Never line any part of the cooker with aluminium foil. **Do not** allow heatproof cooking material, e.g. roasting bags to come into contact with oven elements.



Always stand back from the cooker when opening the oven door to allow any build up of steam or heat to release.



Stand clear when opening the drop down oven door. **Do not** allow it to fall open - support it using the door handle until it is fully open.



Do not place sealed cans or aerosols inside the oven. They may explode if they are heated.

AFTER USE



Ensure that all control knobs are in the OFF position when not in use.



For hygiene and safety reasons this cooker should be kept clean at all times. A build-up of fats or other foodstuffs could result in a fire, especially in the grill pan.



Do not leave utensils containing foodstuffs, e.g. fat or oil in or on the cooker in case it is inadvertently switched ON.

Cookers and hobs become **very hot**, and retain their heat for a long period of time after use. Children should be kept well away from the cooker until it has cooled.

GENERAL



Under no circumstances should repairs be carried out by inexperienced persons as this may cause injury or serious malfunction. This cooker should be serviced by an authorised Service Engineer and only genuine approved spare parts should be used. Details of servicing and repair arrangements are supplied on page 47 of this book.



Do not stand on the cooker or on the open oven door.



Do not hang towels, dishcloths or clothes from the cooker or its handle. They are a safety hazard.



Always allow the cooling fan to cool the cooker down before switching off at the wall prior to carrying out any cleaning or maintenance work.



Only clean this cooker in accordance with the instructions given on page 44.

Your safety is of paramount importance.

Therefore, if you are unsure about any of the meanings of these WARNINGS contact the:

**Consumer Care Department
Telephone: (01582) 585858**

INSTALLATION INSTRUCTIONS

THINGS YOU NEED TO KNOW

WARNINGS:

- This cooker must be installed by a qualified electrician/competent person. Safety may be impaired if installation is not carried out in accordance with these instructions.
- This cooker must be earthed.
- Do not remove the screws from the earth tab extending from the oven mains terminal block (Fig. 6).
- Before connecting the cooker make sure that the voltage of your electricity supply is the same as that indicated on the rating plate. The rating plate can be seen by opening the oven door and looking below the oven door seal.
- Do not alter the electrical circuitry of this cooker.

THINGS TO NOTE

- This cooker is designed to be fitted in cabinets of the recommended dimensions as shown in Fig. 2. If your cabinet interior dimension is between 565-570mm the oven may still be fitted. However a minor modification to the cabinet will be required.
- The dimensions given provide adequate air circulation around the unit within the cabinet, ensuring compliance with BS EN60-335.
- Enquiries regarding the installation of the cooker point if required should be made to your Regional Electricity Company to ensure compliance with their regulations.
- The cooker point should be within 2m of the cooker to make it accessible to switch off the cooker in case of an emergency.
- To protect the hands wear gloves when lifting the oven into its housing.

NOTE: HOUSE CIRCUIT

Earth leakage and continuity tests must be carried out before the cooker is connected to the mains supply and re-checked after fitting.

GETTING THINGS READY

CHOICE OF ELECTRICAL CONNECTION

- There are three possible ways to connect your cooker. In each case the cooker should be operated using at least 6mm² twin core and earth PVC insulated multicore cable. Please choose from the most appropriate after reading the descriptions:

- a) By connecting the cooker to a cooker point having a double pole isolating switch with at least 3mm contact separation in all poles and neutral, and protected with a fuse or miniature circuit breaker at your mains fuse box.

Subject to Regional Electricity Company regulations if you wish to connect the oven and hob to the power supply you may use one of the following two methods:-

- b) By connecting the cooker together with a hob box directly to a cooker point(s). Having a double pole isolating switch with at least 3mm contact separation in all poles and neutral.
- c) If you wish to connect an oven and a hob to a cooker point you can by connecting the oven and hob separately to the cooker point. Oven and hob units should be separately connected to a control panel. See Fig. 1.

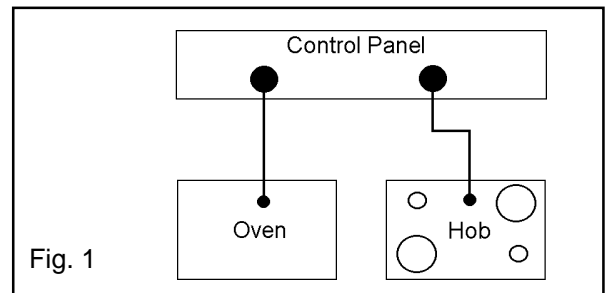

NOTE: It is good practice to:

- Fit an Earth Leakage Circuit Breaker to your house wiring.
- Wire your appliance to the latest IEE regulations.

PREPARING CABINET FOR FITTING OVEN

- Make sure the cabinet is the correct size for the appliance to be fitted (Ref. Fig. 2).
- If the size is between 565-570*mm, then the cabinet should be modified so that at the screw fixing points the recommended dimension of at least 560-565mm is maintained. The modification should ideally be localised to ensure that after screw fitment the oven is **securely** fixed into position.
- The cabinet must be stable and level by firmly securing it to the wall or floor. If necessary, make arrangements to ensure the shelf upon which the oven will rest is level.

RECOMMENDED CABINET DIMENSIONS (IN MILLIMETRES)

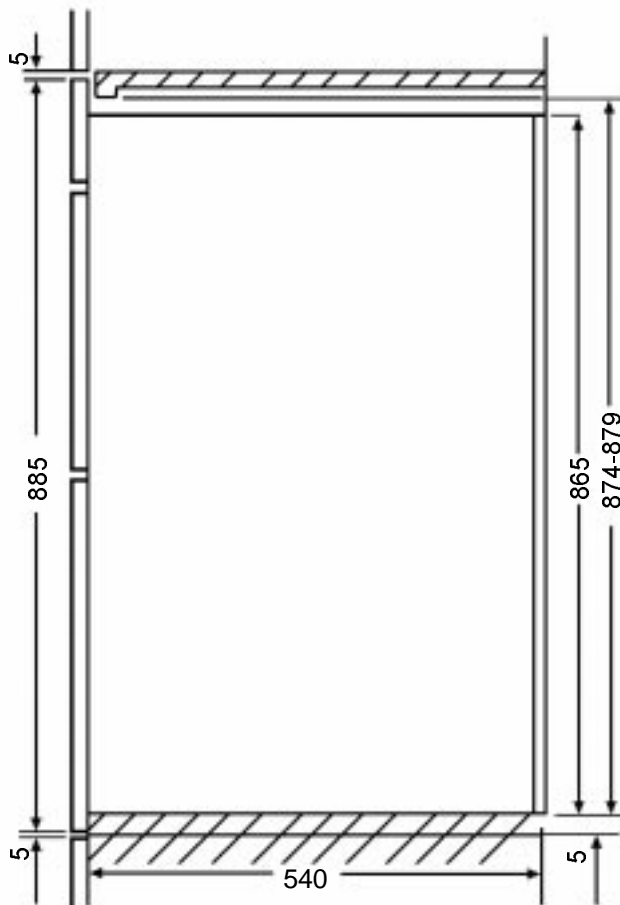
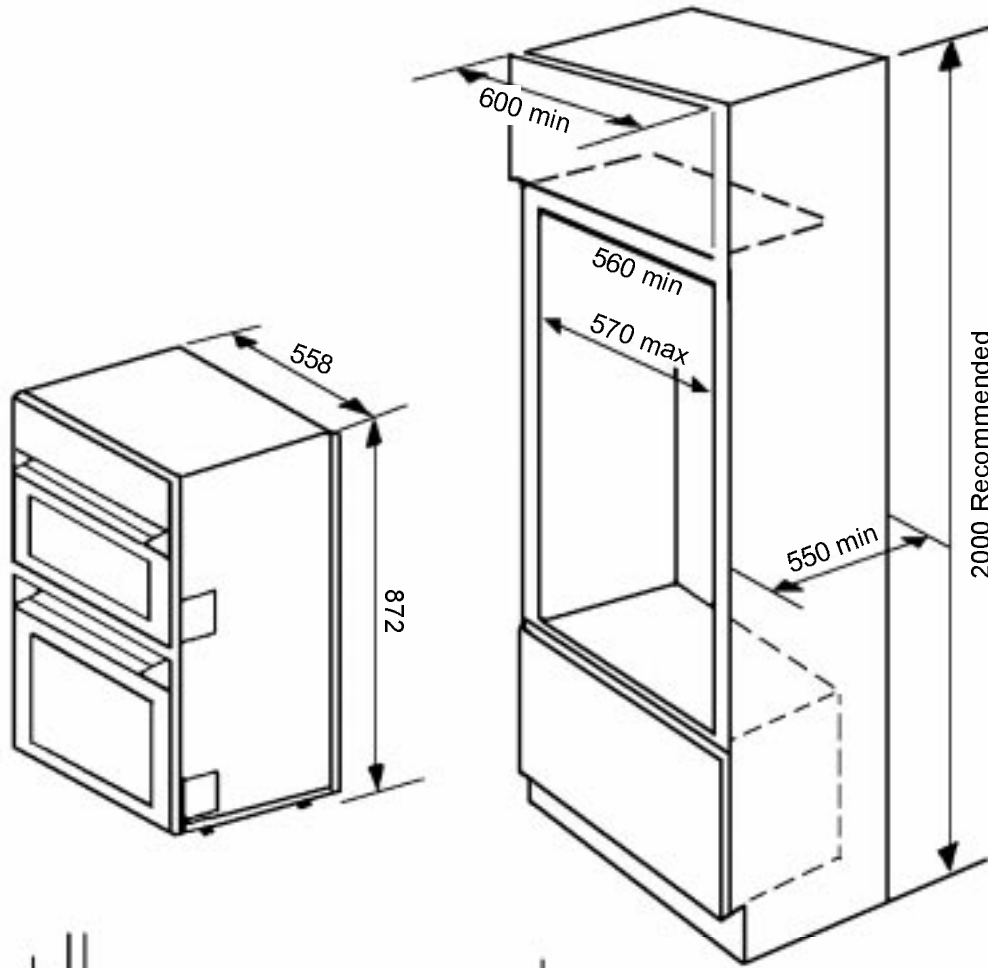

**Cross section
through
cabinet
showing oven
positioned**

Fig.2 Built In Installation

HOW TO FINISH UNPACKING

- Place packed cooker next to the cabinet in which it will be installed.
- Remove the cooker packing except for bottom tray which should be left in position until the cooker is ready to be fitted into its cabinet.
- Ensure the owner is given these operating instructions.

TOOLS REQUIRED

The following tools will be needed and its helps to assemble them before starting to install your oven:

A terminal screwdriver (3mm wide blade)
A pozidrive screwdriver
Pliers
Wirestrippers
Knife
Sidecutters
Adhesive Tape
Tape Measure

MAKING THE ELECTRICAL CONNECTIONS

Important: Switch off at mains, miniature circuit breaker and, if appropriate, remove fuse before commencing any electrical work.

PREPARING CABLE

We recommend you use a new length of cable to ensure your safety.

- Ensure you have the correct length of cable appropriate to the wiring method you are using. When fitting new cable allow sufficient cable for removal of the unit at a later date, should it be necessary.
- Score, but do not cut through, around the sheathing with a knife 100mm (4in) from each end of the cable and break through to the encased wires by bending the cable backwards and forwards to fatigue the sheathing.
- Carefully score down from each end of the cable sheathing along the length of the bare earth wire (if a cut was made along the length of the live and neutral wires, it might cut into their sheathing) to the cuts already made.
- Carefully prise open the sheathing at each end of the cable to expose the encased wiring.

TO REMOVE COVER OF MAINS TERMINAL

From the rear of the cooker, remove mains input terminal cover to gain access to terminal block.

- First remove retaining screw with pozidrive screwdriver. See Fig. 3.

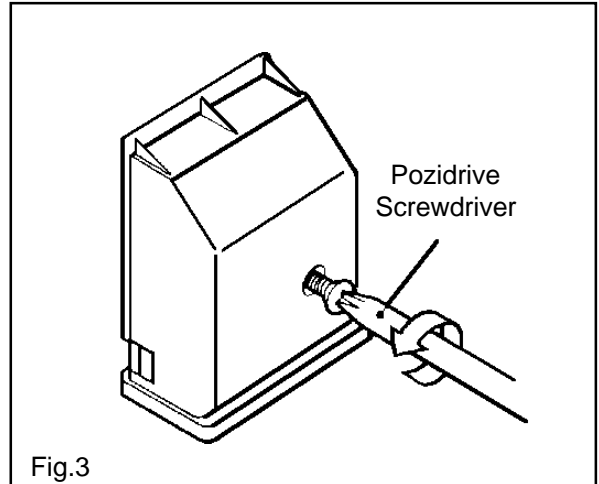

- Prise cover loose using screwdriver in position (1) then lever off with screwdriver in position (2) at either side. See Fig. 4.

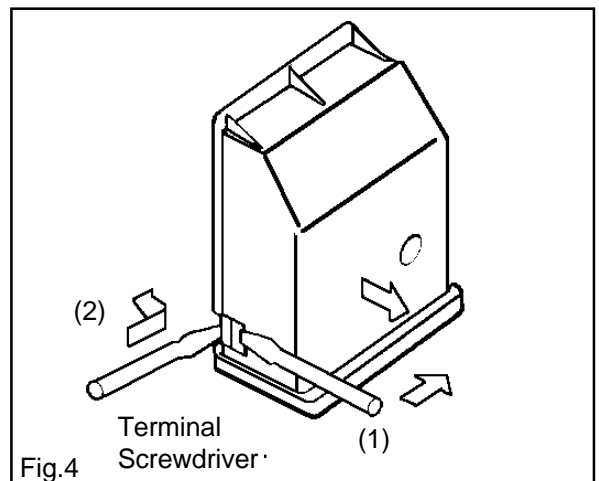

- Lift cover and remove screw from cable clamp. See Fig. 5.

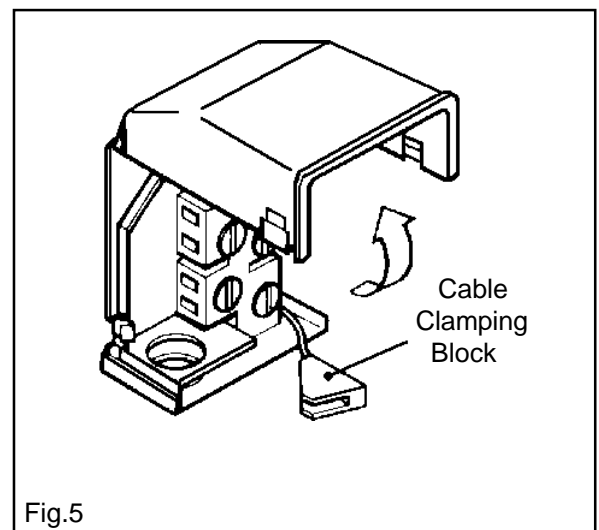

CONNECTING TO THE MAINS TERMINAL

Warning: This cooker must be earthed.

- Make connection as shown in Fig. 6 by proceeding as follows:-

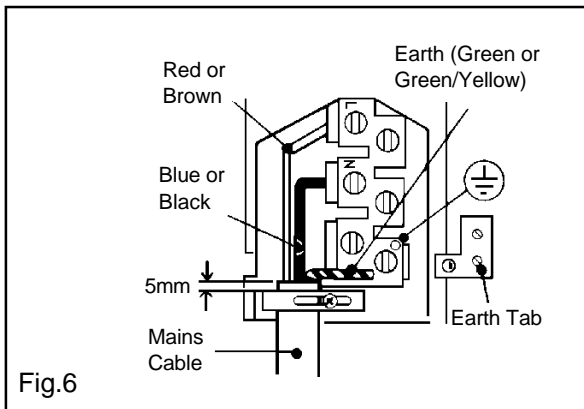

- Preform wires to the appropriate shape to suit fitting into the mains terminal block.
- Strip inner insulation on wires using wirestrippers.
- Twist the bared wires using pliers.
- Cut bared wires 10mm away from the end of the inner insulation. Where uninsulated Earth wires are used ensure they are suitably sheathed to leave 10mm bare wire to fit into the terminal.
- Clamp bare wires into the relevant terminal and check they are held by tugging each one in turn.
- Clamp the mains cable securely ensuring 5mm of the outer insulation is inside the terminal block and that the wires are not taugt but not so slack as to cause any fouling. See Fig. 6.
- Place fuse/ miniature circuit breaker in circuit and switch on at mains.

CONNECTING TO A HOB OR COOKER POINT

Warning: This cooker must be earthed.

- Either follow in general terms the instructions for connecting to the terminal block or refer to the hob suppliers installation instructions.

Feed the cable through the cabinet and arrange to route the cable away from the cooker which may become hot.

CHECKING ELECTRICAL CONNECTIONS

- Confirm the cooker is correctly connected by switching on and observing the various oven functions indicators.
- The electronic timer will flash on and off.

NOTE: HOUSE CIRCUIT

Earth leakage and continuity tests must be carried out before the cooker is connected to the mains supply and re-checked after fitting.

FITTING INTO THE CABINET

IMPORTANT: Ensure that the oven is switched off at the wall before any further work is carried out.

- Using a tape measure establish the internal width of the cabinet. Refer to page 8 if greater than 565mm.
- Position the cooker in front of the cabinet. See Fig. 7.

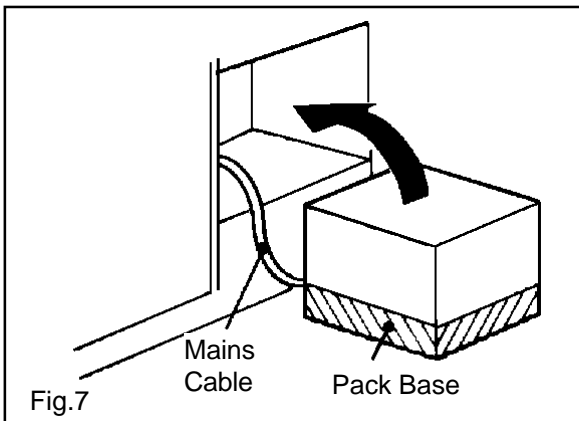

- Take out all oven furniture before installation to reduce the weight you need to lift. The oven door should be taped up to keep it closed whilst lifting.
 - To place the cooker into the cabinetry follow the procedure below:
 - N.B. Two people will be required to carry out the lifting procedure.
- a) Each person should squat either side of the cooker.
 - b) Tilt the cooker so that your hands can support the underside of the cooker.
 - c) Keeping your back straight, raise the appliance to the cabinet by straightening at the knees.
 - d) Rest the rear underside of the cooker on the cabinet floor while your hands support the front.
 - e) The cooker can be pushed fully into the cabinet. Take care to avoid fouling the mains lead.
 - f) Ensure the cooker is central in the cabinet and level.

- g) When the cooker is fully housed, screw the stability screws (supplied with the cooker) into the side of the cabinet taking care not to distort the side trims (see Fig. 8). It is advisable to turn each screw alternately to avoid damaging the trims.
- h) Switch on the cooker then refer to the operating instructions in the following pages.

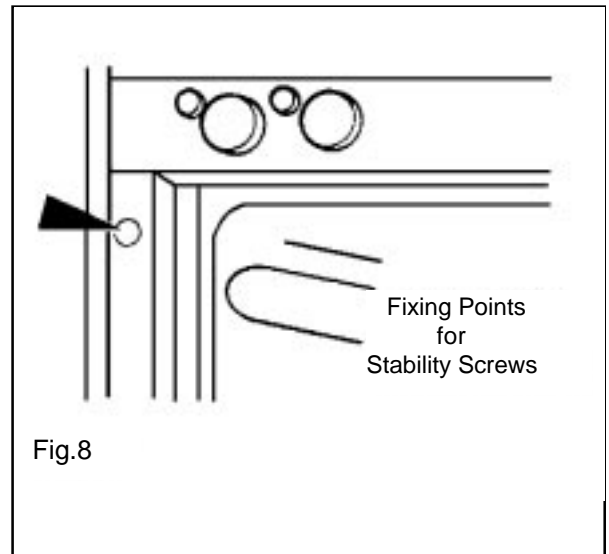







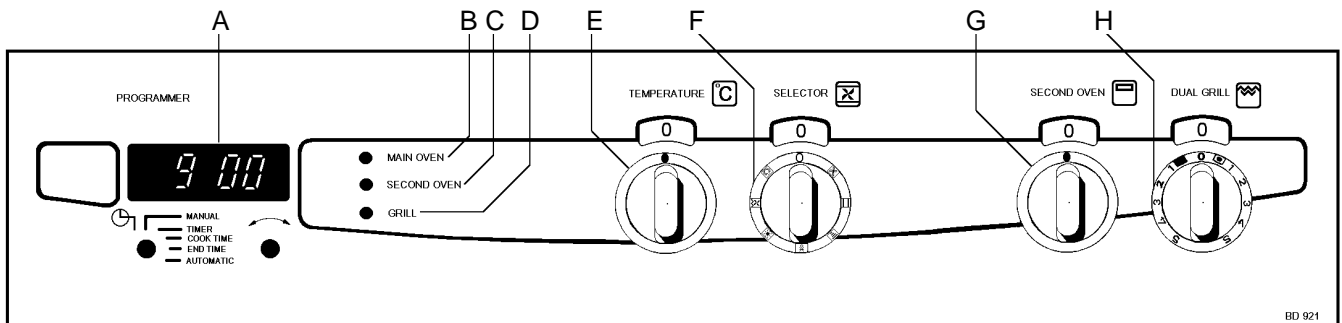

INTRODUCTION

WARNING: THIS COOKER MUST BE EARTHED

This cooker complies with Radio interference requirements of the EEC Directive 87/308/EEC







GETTING TO KNOW YOUR OVEN (BD 921)

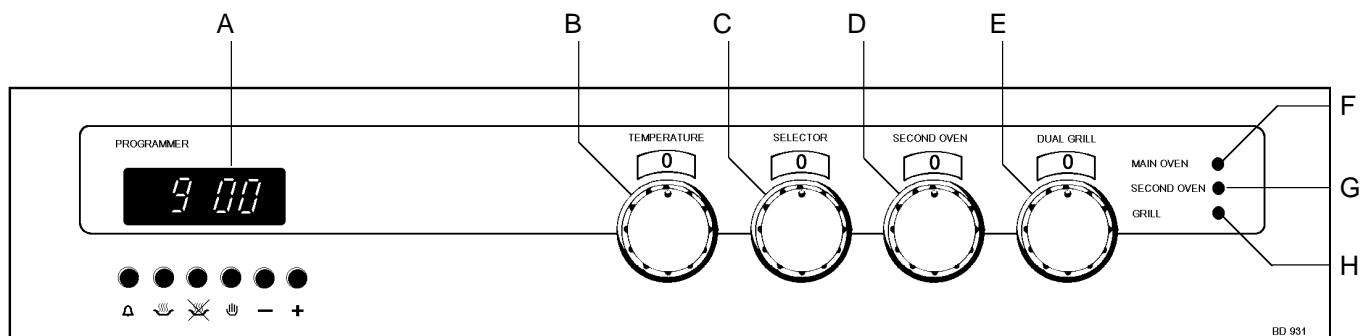

- A - Electronic Timer
- B - Main Oven Indicator Neon
- C - Second Oven Indicator Neon
- D - Dual Grill Indicator Neon
- E - Main Oven Temperature Control
- F - Multifunction Selector
-  Fan Oven
-  Conventional Oven
-  Zoned Oven
-  Defrost
-  Oven Clean
-  Thermal Grilling
-  Oven Light
- G - Second Oven Temperature Control
- H - Dual Grill Control

GETTING TO KNOW YOUR OVEN (BD 931)



- A - Electronic Timer
- B - Main Oven Temperature Control
- C - Multifunction Selector
-  Fan Oven
-  Conventional Oven
-  Zoned Oven
-  Defrost
-  Oven Clean
-  Thermal Grilling
-  Oven Light
- D - Second Oven Temperature Control
- E - Dual Grill Control
- F - Main Oven Indicator Neon
- G - Second Oven Indicator Neon
- H - Dual Grill Indicator Neon

RATING PLATE

Record the model and serial numbers of your cooker on the back cover of this instruction book for future reference. These numbers can be found on the rating plate on the lower front frame of the cooker upon opening the oven door.

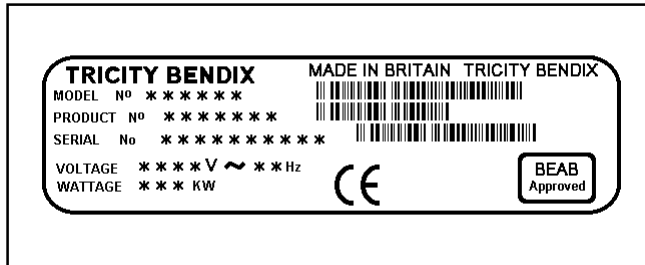

The cooker must be protected by a suitably rated fuse or circuit breaker. The rating of the cooker is given on the rating plate.

GENERAL NOTES ON USING THE OVENS

We suggest that you run all the elements for a short period to burn off any residue from their surfaces.

During this period an unpleasant odour may be emitted, it is therefore advisable to open a window for ventilation.

WHEN FIRST SWITCHING ON

The timer must be set to manual before the ovens can be operated. See pages 36 and 39. This must be done whenever the cooker is switched off at the wall or when there has been a power failure.

If the oven indicator neons do not glow when the controls are switched on, it is most likely that the timer is set for automatic cooking.

ABOUT CONDENSATION AND STEAM

When food is heated it produces steam in the same way as a boiling kettle does. The oven is vented to allow some of this steam to escape. However, always stand back from the cooker when opening the oven door to allow any build up of steam or heat to release.

If the steam comes into contact with a cool surface on the outside of the cooker, e.g. a trim, it will condense and produce water droplets. This is quite normal and is not caused by a fault on the cooker.

To prevent discolouration, regularly wipe away condensation and also soilage from surfaces.

COOKWARE

Baking trays, oven dishes etc., should not be placed directly against the grid covering the fan at the back of the oven.

Do not use baking trays larger than 30cm x 35cm (12" x 14") as they will restrict the circulation of heat and may affect performance. Advice on the effect of different materials and finishes of bakeware is given in 'Hints and Tips' in the appropriate oven section.

THE TRIVET

When roasting do use the trivet in the meat tin. Fat and meat juices will drain into the meat tin below and can be used to make gravy. The trivet also prevents splashes of fat from soiling the oven interior.

N.B. The meat tin should not be placed on a heated hotplate as this may cause the enamel to crack.

THE SHELF POSITIONS

Recommended shelf positions have been shown in the cooking chart on page 30.

If not fitted correctly the shelf will lie at an angle and the safety stop will not be effective. To ensure that the shelf has the correct side uppermost, the wire stringers which make up the shelf should lie on top of the surrounding frame.

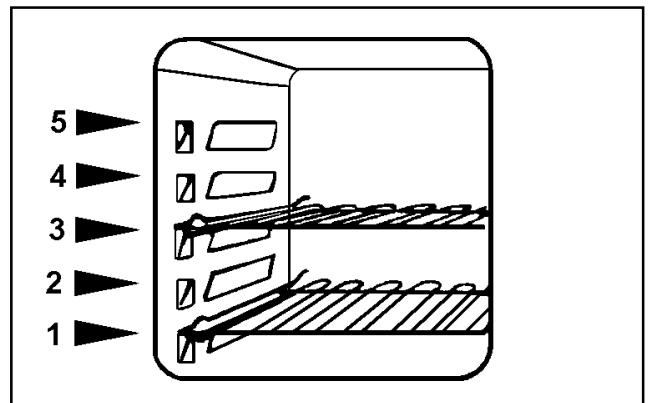

PUSH TO TURN CONTROLS (BD 931 only)

The control knobs must be pushed in towards the panel before they can be turned or adjusted.

THE COOLING FAN FOR THE CONTROLS

The cooling fan comes on immediately when the grill is switched on and after a short time when either of the ovens are in use and switches off when cooking is completed.

During the initial period the cooling fan may cycle ON and OFF, this is quite normal.

It may run on after the ovens or grill are switched off to keep the controls cool.

Always allow the cooling fan to cool the cooker down before switching off at the wall prior to carrying out any cleaning or maintenance work.

NOTE

The action of the cooling fan will depend on how long the oven(s) or grill have been used and at what temperature. It may not switch in at all at lower temperature settings nor run on where the grill or oven has only been used for a short time.

CONTROL PANEL INDICATOR NEONS

These lights indicate whether the grill or ovens are switched ON. In the case of the ovens, the neons also indicate when the set temperature has been reached. They will cycle on and off during use to show that the temperature is being maintained.

If the neons do not operate as the instructions indicate the controls have been incorrectly set. Return all controls to zero and re-set following the instructions for the required setting.

When the oven has been set for automatic cooking the neon should remain unlit during OFF periods.

GRILL AND OVEN FURNITURE

The following items of oven furniture have been supplied with the cooker.

1 grill pan



1 grill pan handle

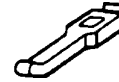

1 grill pan grid

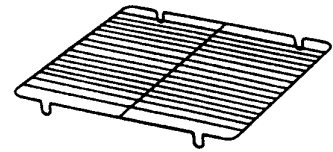

1 grill deflector



1 trivet

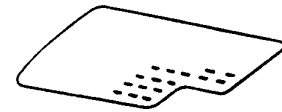

1 meat tin



2 straight shelves

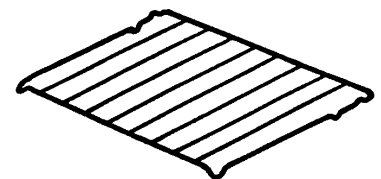

1 cranked shelf for grilling and top oven cooking only

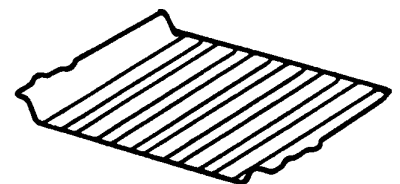

Scuffing of the Stayclean lining by the oven furniture pack may occur during transit.

These marks will disappear after the oven elements have been burnt off for the first time.



USES OF THE DUAL GRILL

CAUTION - ACCESSIBLE PARTS MAY BECOME HOT WHEN THE GRILL IS IN USE. CHILDREN SHOULD BE KEPT AWAY.

The grill is a dual circuit grill which means that the full area of the grill can be used or for economy purposes the centre section only can be used when cooking smaller quantities of food.

SELECTING THE DUAL GRILL

BD 921

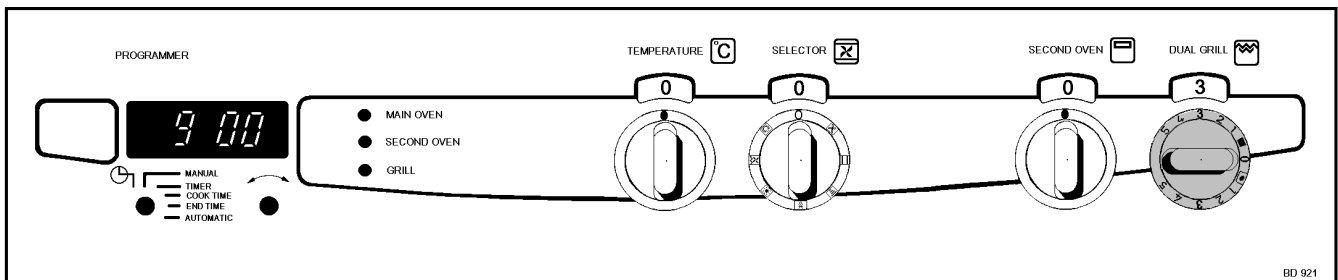

BD 931

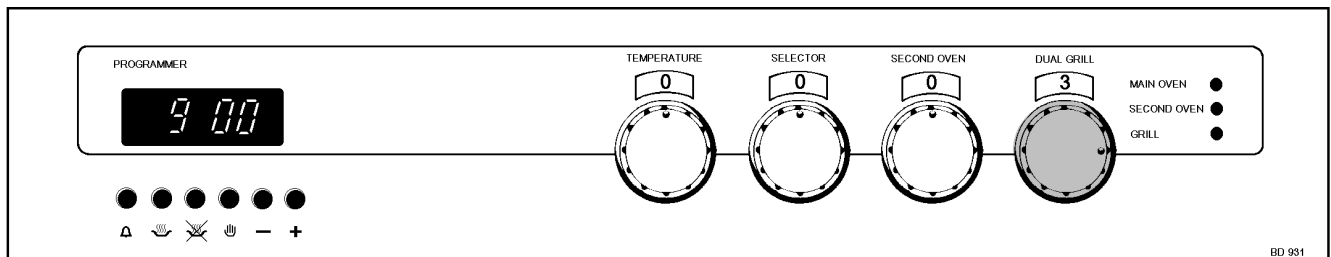

- Turn the grill control clockwise for full grill or anticlockwise for the centre section only.
- Ensure the second oven control is in the OFF position 'O'.
- The dual grill operates independently of the oven.

THINGS TO NOTE

THE GRILL DOOR MUST BE LEFT OPEN DURING GRILLING

1. The cooling fan for the controls will operate immediately in conjunction with the grill.
2. The grill indicator neon will illuminate.
3. The grill indicator window will illuminate.
4. Do not attempt to use the grill when the fan oven has been set to automatic as overheating will occur.
5. The outer grill element may appear to glow slightly brighter than the inner element. This is quite normal.

THE GRILL PAN AND HANDLE

The grill pan is supplied with a removable handle.

To insert the handle, press the button on the handle with the thumb and pivot the handle slightly upwards inserting the lip into widest part of the bracket. Move the handle towards the left, lower into position and release the button.

Ensure the handle is positively located.

To remove the handle, press the button on the handle with the thumb and pivot the handle slightly upwards and towards the right to remove from the bracket.

Ensure your hand is protected when removing the grill pan handle as the grill element can become very hot.

ALWAYS REMOVE THE GRILL PAN HANDLE DURING GRILLING.

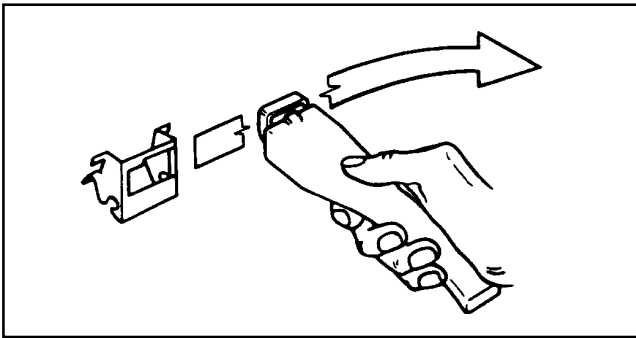

To correctly locate the grill pan on the shelf, ensure that the cut out on the underside of the handle bracket locates over the front bar of the shelf.

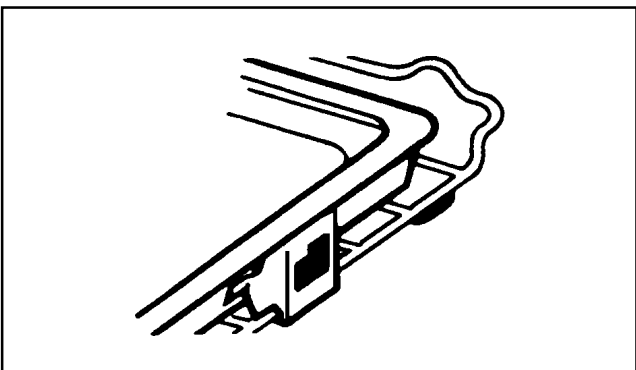

To check the progress of the food being grilled, the grill pan should be withdrawn on the shelf to attend to food during cooking.

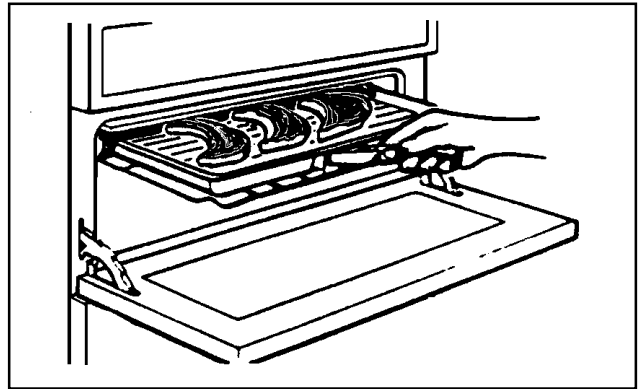

HINTS AND TIPS

- Most foods should be placed on the grid in the grill pan to allow maximum circulation of air to lift the food out of the fats and juices. Food such as fish, liver and kidneys may be placed directly on the trivet in the grill pan if preferred.

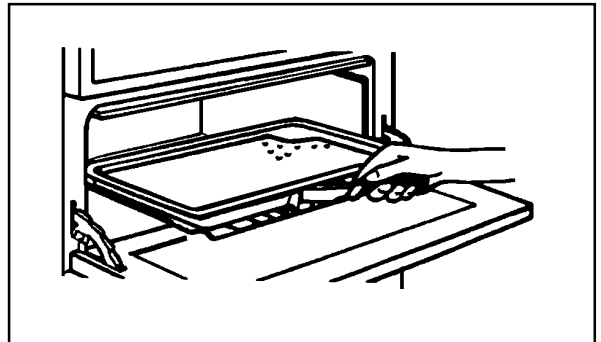

- Adjust the grid and grill pan runner position to allow for different thicknesses of food. Position the food close to the element for faster cooking and further away for more gentle cooking.

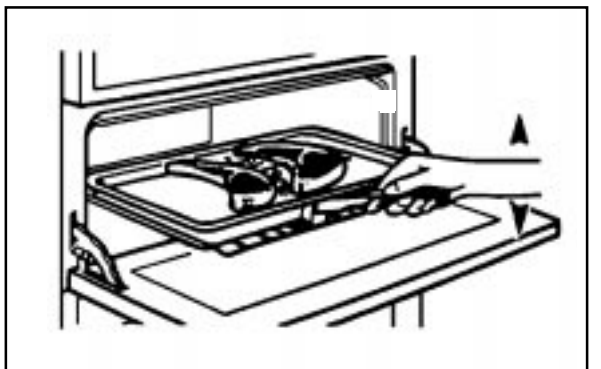

- Food should be thoroughly dried before grilling to minimise splashing. Brush lean meats and fish lightly with a little oil or melted butter to keep them moist during cooking.

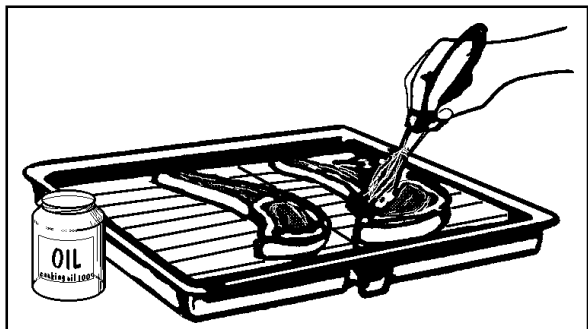

- Accompaniments such as tomatoes and mushrooms may be placed underneath the grid when grilling meats.

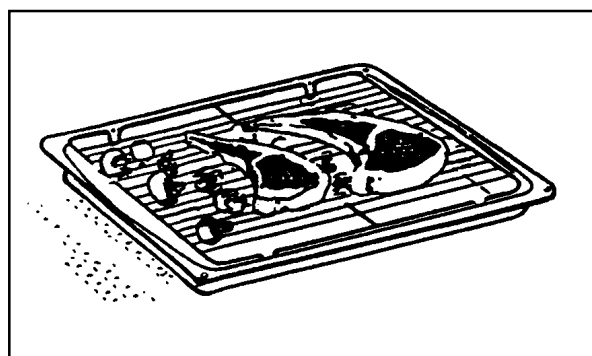

- When toasting bread, we suggest that the top runner position is used with the grid in its 'High' position.
- Preheat the grill on a full setting for a few minutes before sealing steaks or toasting. Adjust the heat setting and the shelf as necessary during cooking.
- The food should be turned over during cooking as required.
- The grill door must be left open when grilling.

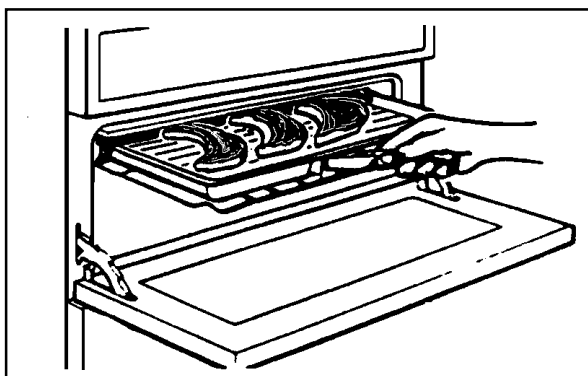

GRILLING CHART

FOOD	SHELF	GRILL TIME (mins in total)
Toast	2crk.	4-6
Bacon Rashers	2crk.	10
Beefburgers	2crk.	10-15
Chicken Joints	2crk.	30-40
Chops - Lamb	2crk.	15-20
Pork	2crk.	20-30
Fish - Whole Trout/Mackerel	2crk.	15-25
Fillets - Plaice/Cod	2crk.	15
Kebabs	2crk.	20-30
Kidneys - Lamb/Pig	2crk.	8-12
Sausages	2crk.	20-30
Steaks - Rare	2crk.	6-12
Medium	2crk.	12-16
Well Done	2crk.	14-20
Toasted Sandwiches	2crk.	3-4

crk. = cranked shelf

Shelf positions are counted from the bottom of the oven upwards.

The times and shelf positions quoted above are given as a guide and should be adjusted to suit personal taste.

THE SECOND OVEN



USES OF THE SECOND OVEN

The second oven is the smaller of the two ovens. It is heated by elements in the top and bottom of the oven. It is designed for cooking smaller quantities of food. It gives especially good results if used to cook fruit cakes, sweet and savoury flans or quiche.

The second oven is also ideal for use as warming compartment to warm dishes and keep food hot. Use a temperature setting of 80° - 100°C on the second oven temperature control.

SELECTING THE SECOND OVEN

BD 921

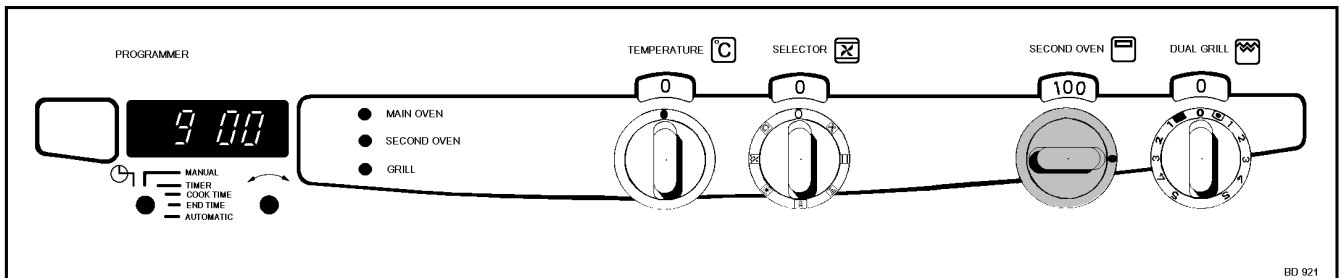

BD 931

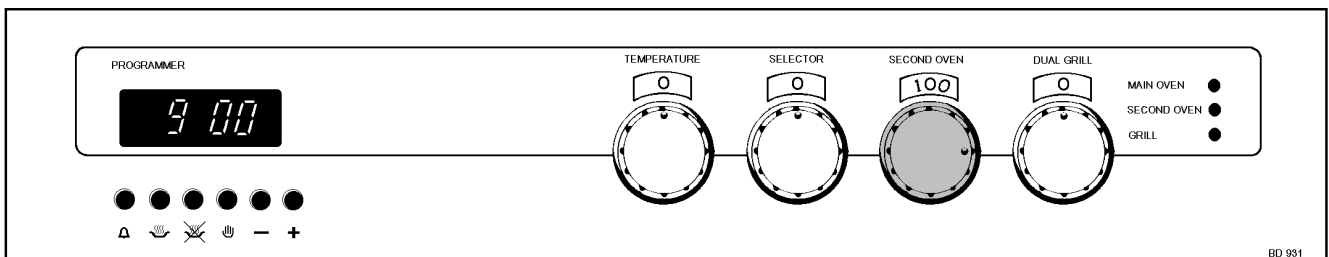

- Ensure the grill control is in the off 'O' position .
- Turn the second oven temperature control to the required setting.

THINGS TO NOTE

1. The second oven neon will glow until the oven has reached the desired temperature and then go out. It will cycle ON and OFF periodically during cooking showing that the temperature is being maintained.
2. The second oven indicator window will illuminate.
3. The controls cooling fan will operate after a time. See page 16 for more information on the cooling fan.

4. The second oven works independently of the main oven and is not controlled by the selector.
5. Dishes, tins and trays should not be placed directly on oven floor as it becomes very hot and damage will occur.

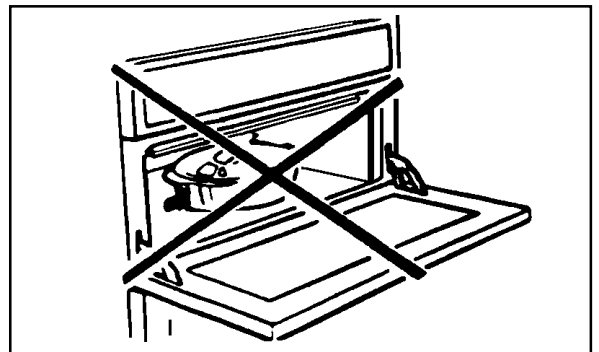

TO FIT THE TOP OVEN SHELF

The shelf should be fitted with the straight rods uppermost on the frame and the forms towards the back of the oven. If not fitted correctly the anti-tilt and safety stop mechanism will be affected.

HINTS AND TIPS

- There should always be at least 2.5cm (1") between the top of the food and the element. This gives best cooking results and allows room for rise in yeast mixtures, Yorkshire puddings etc. When cooking cakes, pastry, scones bread etc., place the tins or baking trays centrally below the element.
- Ensure that food is placed centrally on the shelf and there is sufficient room around the baking tray/dish to allow for maximum circulation.

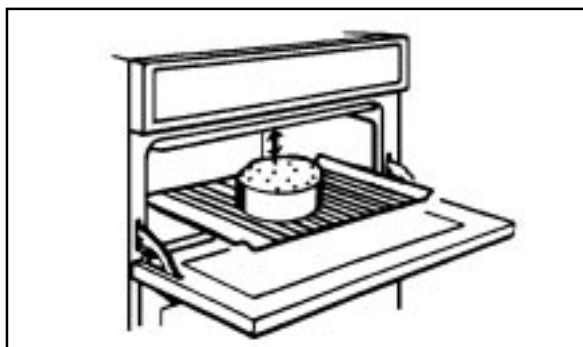

- Stand dishes on a suitably sized baking tray on the shelf to prevent spillage onto the oven base and to help reduce cleaning.
- The material and finish of the baking tray and dishes will affect the degree of base browning of the food. Enamelware, dark, heavy or non-stick utensils increase base browning. Shiny aluminium or polishes steel trays reflect the heat away and give less base browning.
- **DO NOT** place dishes or baking trays directly onto the oven base as it becomes very hot and damage may occur.
- **DO NOT** use the grill pan or meat tin as a baking tray as this will increase base browning of the food.
- Because of the smaller cooking space, lower temperatures and shorter cooking times are sometimes required. Be guided by the recommendations below.

- For economy leave the door open for the shortest possible time, particularly when placing food into a pre-heated oven.

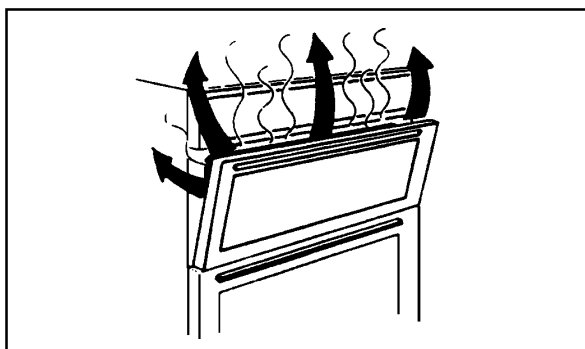

SECOND OVEN COOKING CHART

FOOD	Shelf Position	Cooking Temp°C
Biscuits	2crk.	180-190
Bread	1crk.*	210-220
Casseroles	1crk.*	130-140
Cakes:		
Small/queen	2 crk.	180-190
Sponges	2crk.	160-170
Madeira	1crk.	140-150
Rich Fruit	1crk.	130-140
Christmas	1crk.	130-140
Meringues	1crk.	90-100
Fish	1crk.	170-190
Fruit Pies & Crumble	1crk.	190-200
Milk Puddings	1crk.	140-150
Pastry: Choux	1crk.	160-170
- Shortcrust	} Depending on dish	
- Flaky		
- Puff		
Plate Tarts	2crk.	190
Quiches/Flans	1crk.	180
Scones	2crk.	210-220
Roasting:		
Meat & Poultry	1crk.*	170-180

crk. = Cranked shelf

* or on a straight shelf from the main oven on the base.

THE MAIN FAN OVEN



USES OF THE FAN OVEN

The oven is heated by an element around the fan situated behind the back panel. The fan draws air from the oven and the element heats the air which is circulated into the oven via the vents in the back panel. The advantages of fan oven cooking are:

PREHEATING

The fan oven quickly reaches its temperature, so it is not usually necessary to preheat the oven. Without preheating however, you may find you need to add an extra 5-10 minutes on the recommended cooking times. For recipes needing high temperatures, e.g. bread, pastries, scones, soufflés, etc., best results are achieved if the oven is preheated first.

COOKING TEMPERATURES

Fan oven cooking generally requires lower temperatures than conventional cooking. Follow the temperatures recommended in the chart on page 30 and in the recipes given in the cookbook supplied with the cooker. As a guide reduce temperatures by about 20°C-25°C for your own recipes.

BATCH BAKING

The fan oven cooks evenly on all shelf levels, especially useful when batch baking.

SELECTING THE FAN OVEN

BD 921

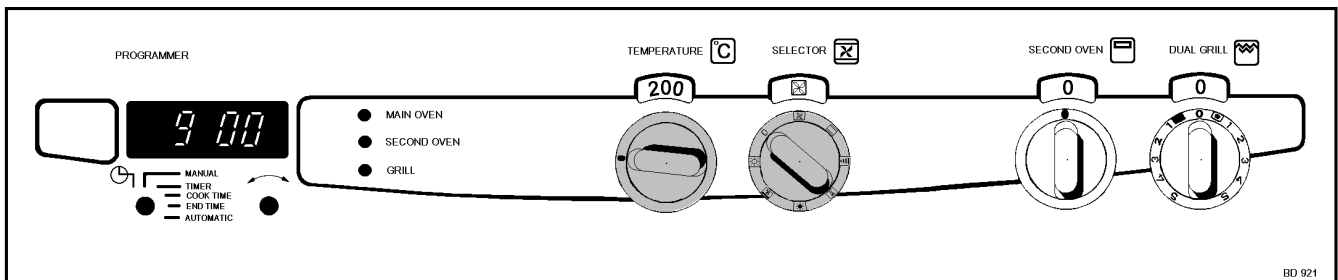

BD 931

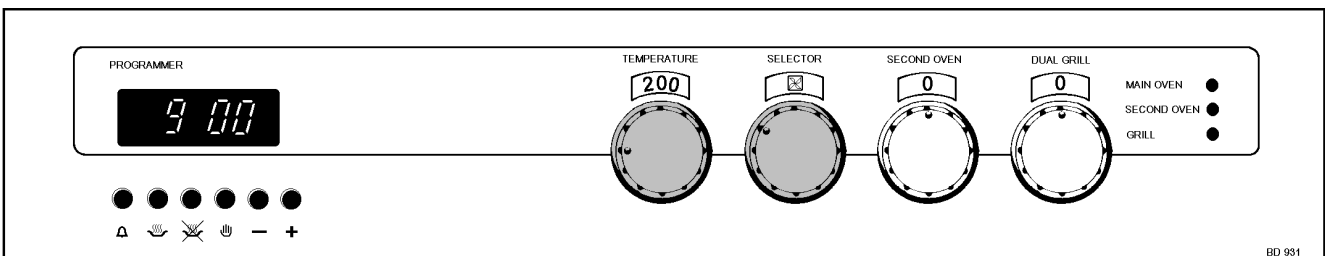

- Turn the selector to Fan Oven .
- Turn the main oven temperature control to the required setting.

NOTE:

- a) The selector and main oven indicator windows will illuminate.
- b) The oven light will come on.
- c) The cooling fan for the controls will operate after a time. See page 16 for further details on the operation of the cooling fan.

THINGS TO NOTE

1. The oven fan will operate continually during cooking.
2. The oven indicator neon will glow until the oven has reached the desired temperature. It will cycle ON and OFF periodically during cooking showing that the temperature is being maintained.
3. The oven light operates when the selector is set.
4. If an automatic programme is set, the oven fan and oven light do not come on until the cook time begins.

TO FIT THE MAIN OVEN SHELVES

The shelves should be fitted with the straight rods uppermost on the frame and the forms towards the back of the oven. If not fitted correctly the anti-tilt and safety stop mechanism will be affected.

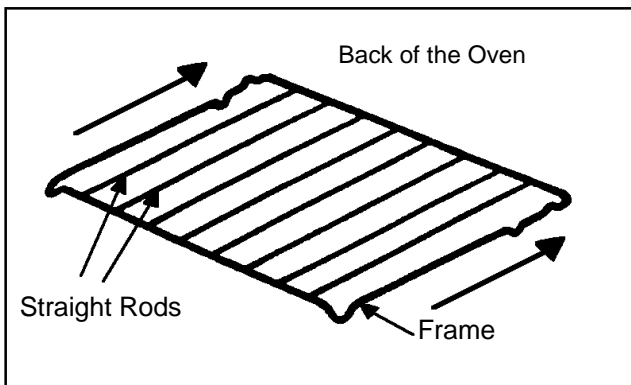

HINTS AND TIPS

- Arrange the shelves in the required positions before switching the oven ON. Shelves are numbered from the bottom upwards.

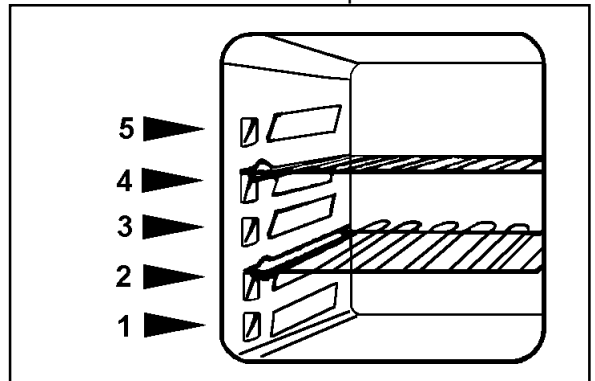

- When cooking more than one dish in the fan oven, place dishes centrally on different shelves rather than cluster several dishes on one shelf, this will allow the heat to circulate freely for the best cooking results.
- When batch baking one type of food, e.g. Victoria sandwich cakes, those of similar size will be cooked in the same time.

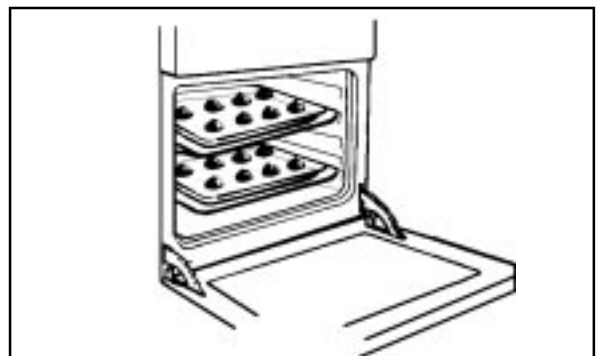

- It is recommended that when baking larger quantities, the shelf positions should be evenly spaced to suit the load being cooked. A slight increase in cooking time may be necessary.
- The use of excessively high temperatures can cause uneven browning. It may be necessary to reduce temperatures slightly. Refer to the recommendations given in the oven cooking chart, see page 30.

DEFROST FEATURE



USES OF DEFROST FEATURE

This function enables you to defrost most foods faster than some conventional methods as the oven fan circulates air around the food. It is particularly suitable for delicate frozen foods which are to be served cold e.g. cream filled gateaux, cakes covered with icings or frostings, cheesecakes, biscuits, scones etc.

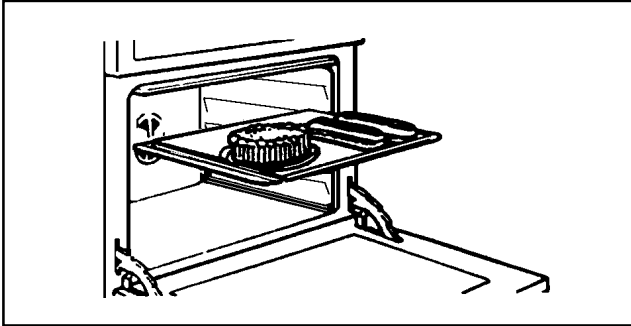

It is preferable to thaw fish, meat and poultry slowly in the fridge. However, this process can be accelerated by using the defrost function.

Small or thin fish fillets, frozen peeled prawns, cubed or minced meat, liver, thin chops, steaks etc., can be thawed in 1 - 2 hours.

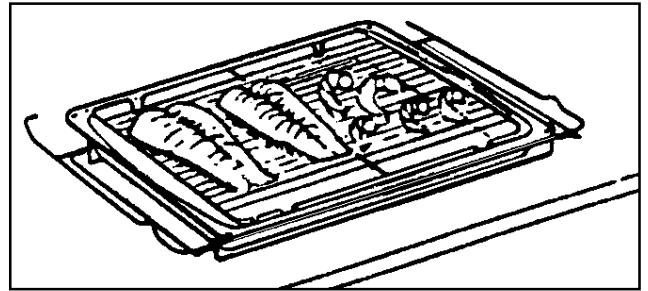

A 1kg/2¼lb oven ready chicken will be thawed in approximately 5 hours. Remove the giblets as soon as possible during the thawing process.

Joints of meat up to 2kg/4½lb in weight can be thawed using the defrost function.

ALL JOINTS OF MEAT AND POULTRY MUST BE THAWED THOROUGHLY BEFORE COOKING.

ALWAYS COOK THOROUGHLY IMMEDIATELY AFTER THAWING.

SELECTING DEFROST

BD 921

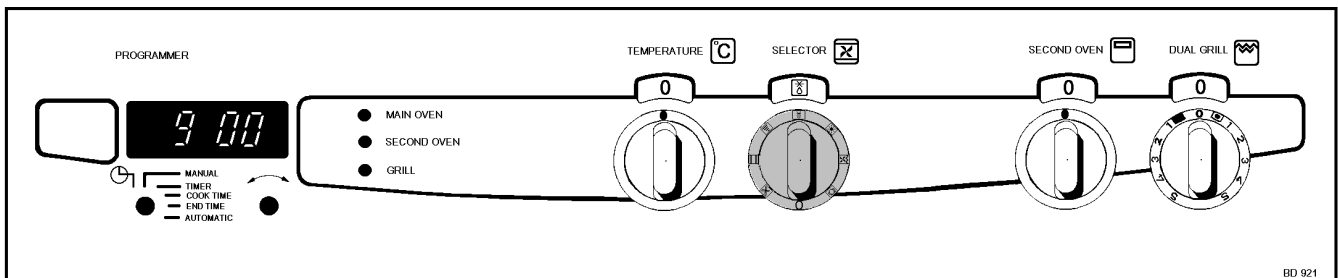

BD 931

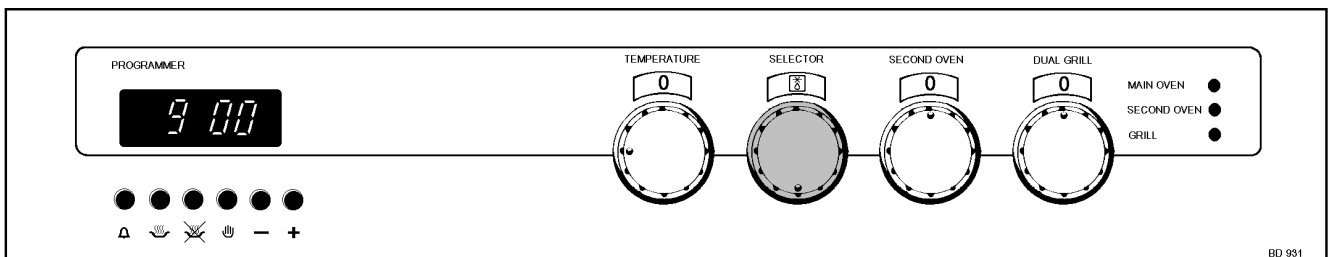

- Turn the multifunction selector to Defrost
- This function **DOES NOT** require a temperature setting on the main oven temperature control

THINGS TO NOTE

- a) The selector indicator window will illuminate.
- b) The oven fan and internal oven light will operate.

HINTS AND TIPS

- Place the frozen food in a single layer where possible and turn it over half way through the defrosting process.

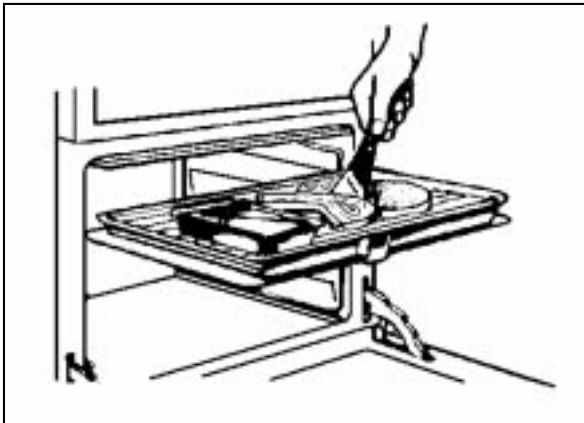

- The actual speed of defrosting is influenced by room temperature. On warm days defrosting will be faster than on cooler days.
- DO NOT leave food at room temperature once it is defrosted. Cook raw food immediately or store cooked food in the fridge.
- Care must always be taken when handling foods in the home. Always follow the basic rules of food hygiene to prevent bacterial growth and cross contamination when defrosting, preparing, cooking cooling and freezing foods. See Helpful Hints on Buying and Preparing Food on page 43.

THE CONVENTIONAL OVEN



USES OF THE CONVENTIONAL OVEN

This function uses the top and lower elements to give single level cooking. This is particularly suitable for dishes which require extra base browning such as pizzas, quiches and flans. Gratins, lasagnes and hotpots which require extra top browning also cook well in the conventional oven. This form of cooking gives you the opportunity to cook without the fan oven in operation.

SELECTING THE CONVENTIONAL OVEN

BD 921

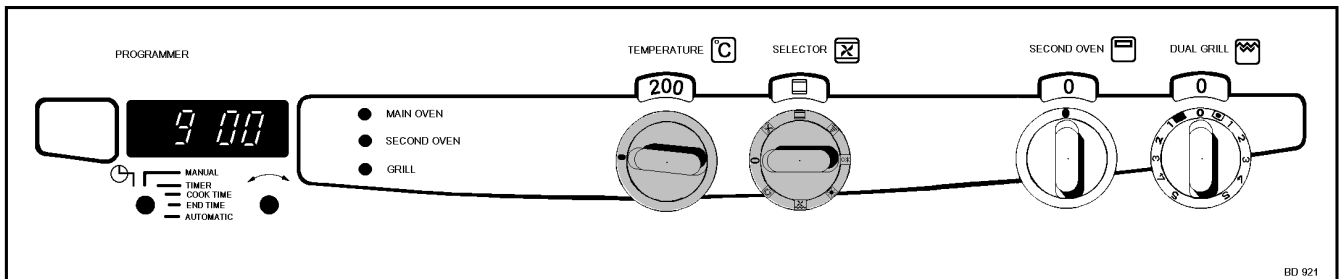

BD 931

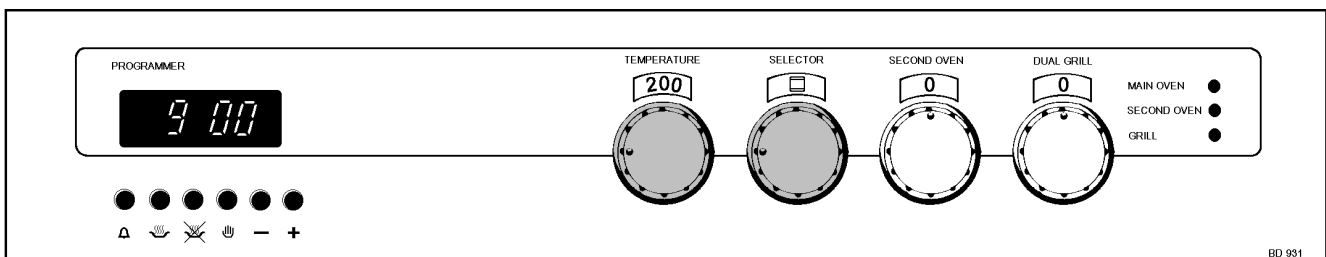

- Turn the multifunction selector to Conventional Oven .
- Turn the main oven temperature control to the required setting.

NOTE:

- a) The selector and oven temperature indicator windows will illuminate.
- b) The oven indicator neon will glow.

THINGS TO NOTE

1. The oven indicator neon will glow until the oven has reached the desired temperature and then go OUT. It will then cycle ON and OFF showing that the oven temperature is being maintained.
2. The internal oven light operates when the selector is set. If an automatic programme is set, the oven light will come on when the cook time starts.
3. The control cooling fan will operate after a short time and runs on after the controls are switched off until the appliance has cooled. See page 16 for more details on the cooling fan.

HINTS AND TIPS

- The middle shelf allows for the best heat distribution. To increase base browning simply lower the shelf position. To increase top browning, raise the shelf position.

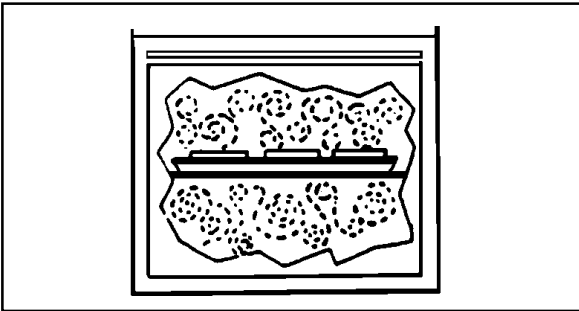

- The material and finish of the baking trays and dishes used will affect base browning. Enamelware, dark heavy or non-stick utensils increase base browning, while oven glassware, shiny aluminium or polished steel trays reflect the heat away and give less base browning.
- Always place dishes centrally on the shelf to ensure even browning.

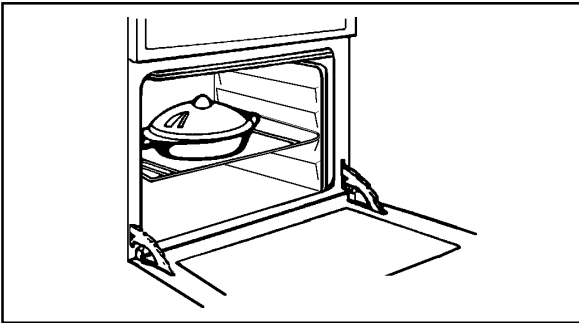

- Stand dishes on suitably sized baking trays to prevent spillage onto the base of the oven and make cleaning easier.
- **Do not** place dishes, tin or baking trays directly on the oven base as it becomes very hot and damage will occur.

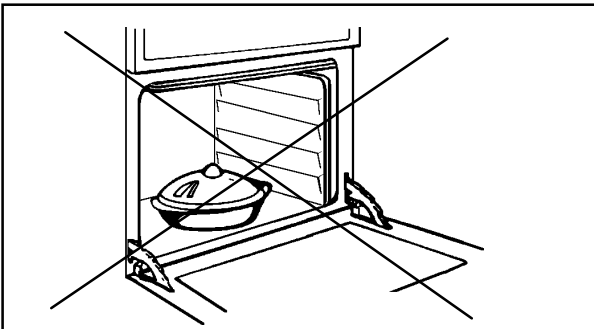

- For faster preheating use the fan oven function to preheat the oven until the oven indicator neon goes out, then switch the selector to the conventional oven setting.
- Single level cooking gives best results. If you require more than oven level cooking use the fan or zoned oven functions.



USES OF THE ZONED OVEN

When the Zoned Oven is selected the top oven element operates in conjunction with the fan with effect that the top of the oven is hotter than the bottom. As there is a difference of up to 30°C between the top and bottom of the oven this feature is especially useful for dishes requiring different temperatures at the same time, making it ideal for cooking a complete meal on two shelves.

SELECTING THE ZONED OVEN

BD 921

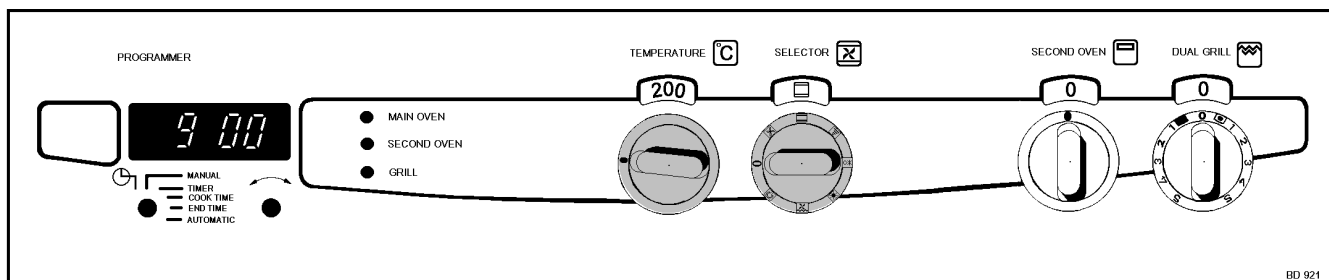

BD 931

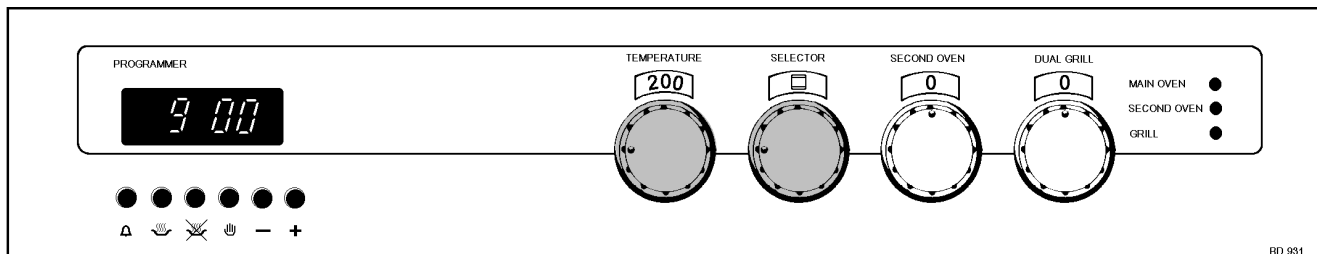

- Turn the multifunction selector to Zoned Oven.

- Turn the main oven temperature control to the required setting.

NOTE:

- a) The selector and oven temperature indicator windows will illuminate.
- b) The internal oven light and oven indicator neon will illuminate.

THINGS TO NOTE

1. If an automatic programme is set, the internal oven light will come on when the cook time starts.
2. The oven indicator neon will glow until the oven has reached the desired temperature and then go OUT. It will then cycle ON and OFF showing that the oven temperature is being maintained.
3. The control cooling fan will operate after a short time. It runs on after the controls are switched off until the appliance has cooled. See page 16 for further details on the cooling fan.

HINTS AND TIPS

- Remember that the top of the oven is hotter than the bottom. The approximate difference in temperature between the top and the bottom is 30°C.
- If a higher shelf position is used than is recommended in the chart on page 30 it may be necessary to lower the cooking temperature by approximately 10°C.
- Be prepared to interchange dishes between the higher and lower shelf position during cooking where necessary.

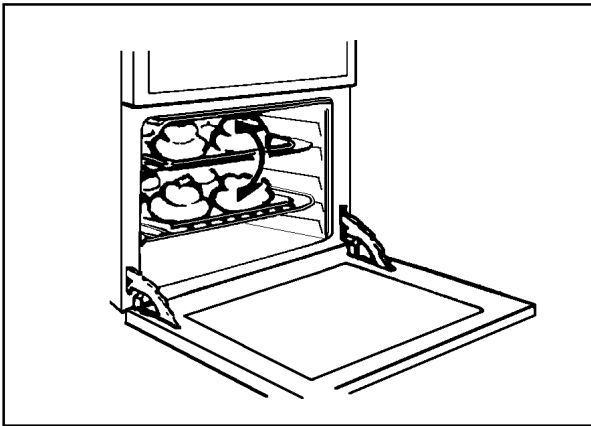

- It is best to cover dishes where practical for part of the cooking time to prevent over browning. Covering the food will also reduce fat splashing onto the oven interior and help to keep the oven clean. Uncover food for the last 15-30 minutes of cooking time to allow the food to brown.

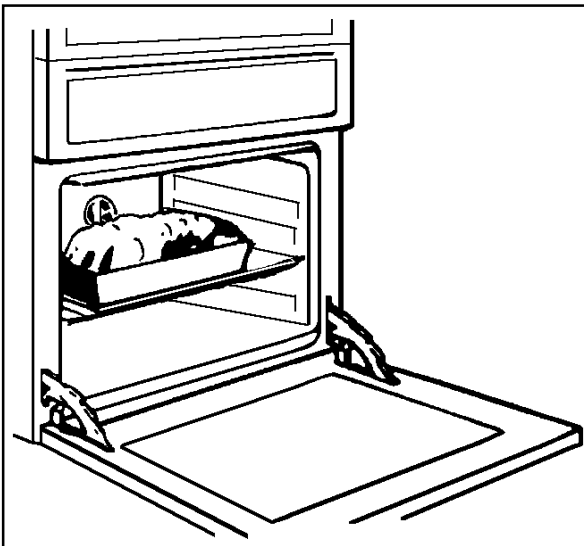

- Ensure that food is placed centrally on the shelves and that there is sufficient room around the dishes to allow for maximum air circulation.

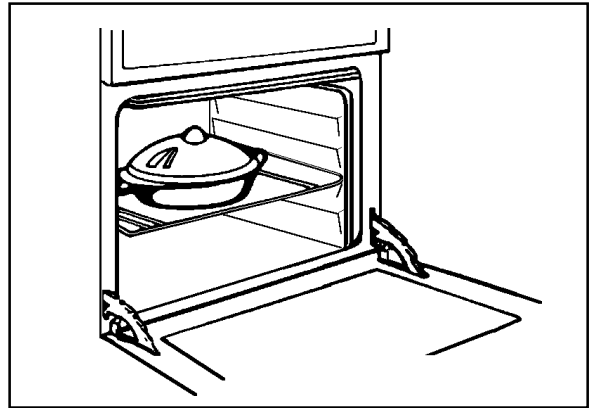

- The use of enamelware or dark, heavy or non-stick utensils will help to increase base browning for dishes such as Yorkshire Pudding, Plate Pies etc.
- For faster preheating use the fan oven function to preheat the oven until the oven indicator neon goes out, then switch to the zoned oven following the times, temperatures and shelf positions recommended.

OVEN COOKING CHART

The oven temperatures are intended as a guide only. It may be necessary to increase or decrease the temperatures by 10°C to suit individual preferences and requirements.

Note: Shelf positions are counted from the bottom of the oven.

Food	FAN OVEN		ZONED OVEN		CONVENTIONAL OVEN	
	Shelf Position	Cooking Temp °C	Shelf Position	Cooking Temp °C	Shelf Position	Cooking Temp °C
Biscuits		180-190	1/3	160-170	2	180-190
Bread		210-220	2	200-210	2	210-220
Casseroles	Shelf	130-140	3	160-170	2	150-180
Cakes: Small & Queen	positions are not critical but ensure that oven shelves are evenly spaced when more than one is used	160-170	1/3	160-170	2	170-180
Sponges		160-170	1/3	160-170	2	170-180
Madeira		140-150	2	140-150	2	160-170
Rich Fruit		130-140	1	130-140	2	150-160
Christmas		130-140	-	-	1	130-140
Meringues		90-100	1/3	90-100	2	100-110
Fish		170-190	1/3	160-180	2	170-190
Fruit Pies and Crumbles		190-200	3	190-200	3	190-200
Milk Puddings		130-140	3	130-140	3	130-140
Pastry: Choux	}	190-200	3	160	2	160-170
Shortcrust			1/3	170-180	3	190-200
Flaky						
Puff						
Plate Tarts		180-190	1/3	170-180	2	190-200
Quiches/Flans		170-180	3	170-180	2	190-200
Scones		210-220	1/3	210-220	3	230
Roasting: Meat and Poultry		160-180	2	160-180	2	180-200

Do not use the cranked shelf from the grill/top oven in the main oven.



USES OF THERMAL GRILLING

Thermal grilling offers an alternative method of cooking food items normally associated with conventional grilling.

The grill element and the fan operate together, circulating hot air around the food. The need to check and turn food is reduced. Thermal grilling helps to minimise cooking smells in the kitchen and allows you to grill with the oven door closed. With the exception of toast and rare steaks you can thermal grill all the foods you would normally cook under a conventional grill.

The lower part of the oven can be used to cook accompaniments at the same time, e.g. tomatoes and mushrooms with a mixed grill or breakfast.

Dishes prepared in advance such as shepherd's pie, lasagne and au gratins can be heated through and browned on the top using the thermal grilling function.

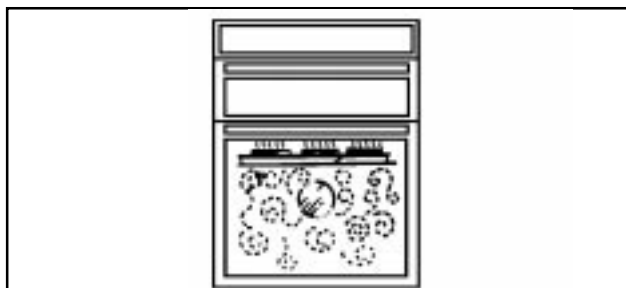

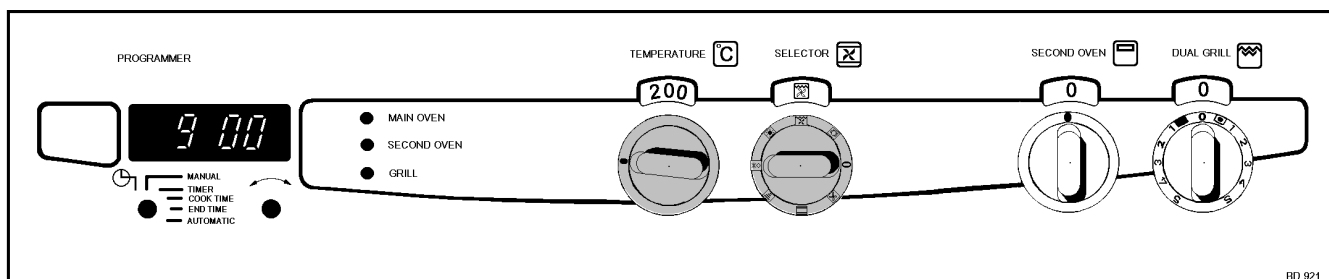

SELECTING THERMAL GRILLING

BD 921

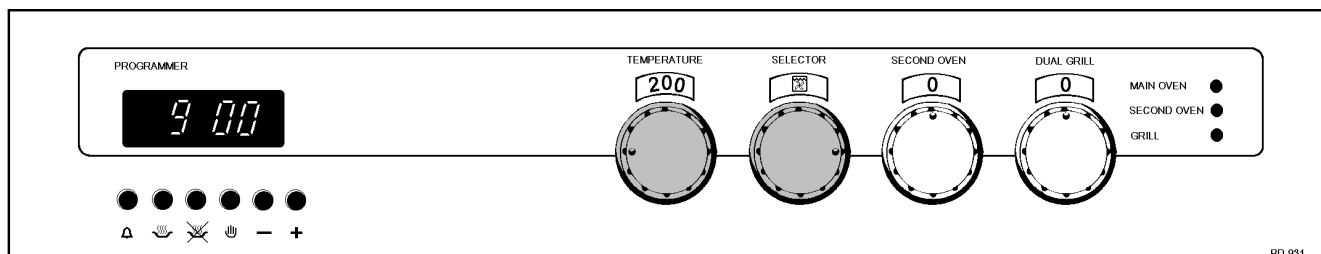

BD 931



- Turn the multifunction selector to Thermal Grill.

- Turn the main oven temperature control to the required setting. (A temperature of between 140°C and 220°C is suitable for thermal grilling).

NOTE:

Thermal grilling helps to minimise cooking smells in the kitchen and is carried out with the main oven door closed.

THINGS TO NOTE

1. The oven indicator neon will glow until the oven has reached the desired temperature and then go OFF. It will cycle ON and OFF showing that the oven temperature is being maintained.
2. The indicator windows for selector and oven temperature control will illuminate.
3. The oven fan and internal oven light will come on.
4. The control cooling fan will operate after a short time. It will run on after the controls are switched off until the appliance has cooled. See page 16 for more details on the operation of the cooling fan.
5. Always thermal grill with the door closed and with the grill pan handle removed.

HINTS AND TIPS

- Prepare foods in the same way as for conventional grilling. Brush lean meats and fish lightly with a little oil or butter to keep them moist during cooking.

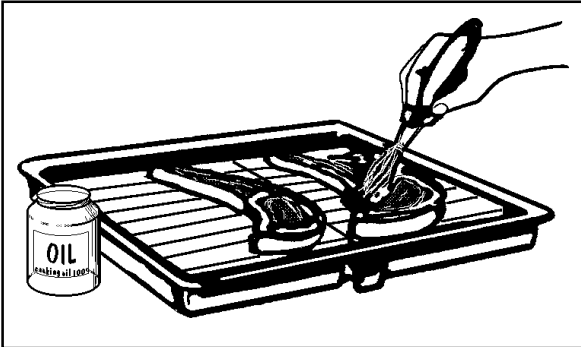

- Most food should be placed on the grill pan grid in the 'high' position in the grill pan to allow maximum circulation of air around the food. Food such as fish, liver and kidneys may be placed directly onto the trivet in the grill pan if preferred.
- The use of the trivet beneath the grid when grilling fatty foods will help minimise splashing.

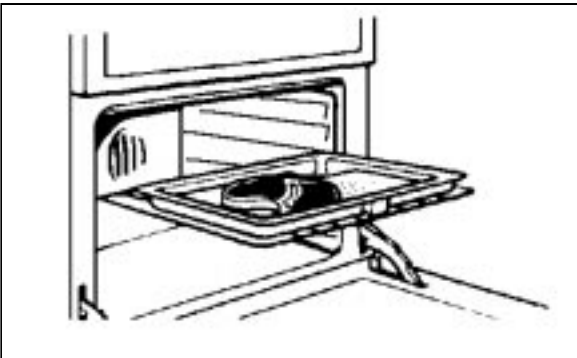

- Accompaniments such as tomatoes and mushrooms may be placed below the grid when grilling meats, or in a separate dish on a lower shelf.

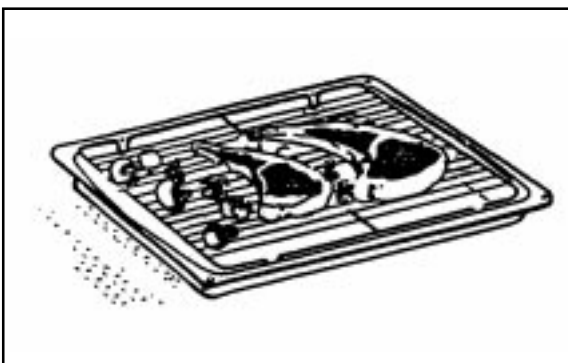

- Foods will cook more quickly the closer they are to the grill element and the higher the temperatures selected. Be prepared to adjust temperatures and shelf positions during cooking if necessary.

- Turn food over during cooking as necessary.

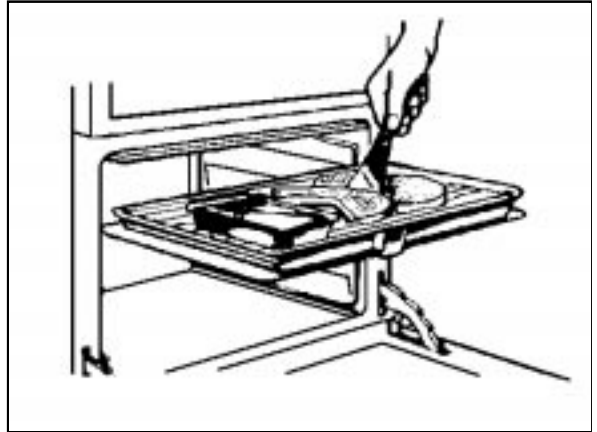

- Ensure that ready prepared or cooked chilled dishes e.g. shepherds pie, moussaka, lasagne, etc., are piping hot throughout before serving.
- A temperature range of 140-220°C and shelf positions 3 and 4 are suitable for most foods. Be prepared to make suitable adjustments during cooking to suit individual requirements. If thermal grilling on more than one level, it may be necessary to interchange the food on the shelves during cooking.

COOKING TIMES

Cooking is more gentle, therefore food generally takes a little longer to cook when thermal grilling compared with conventional grilling. One of the advantages is that larger loads can be cooked at the same time.

A general guide to cooking times is given on page 34 but these times may vary slightly depending on the thickness and quantity of food being cooked.

THERMAL GRILLING CHART

FOOD	SHELF	TEMP (°C)	TIME (mins in total)
Bacon Rashers	3	200	8-12
Beefburgers	3	190	10-15
Chicken Joints	3	160	35-45
Chops - Lamb	3	170	20-25
- Pork	3	170	25-35
Fish - Whole Trout	3	170	10-20
- Mackerel	3	170	10-20
Filletts - Plaice/Cod	4	170	10-15
Kebabs	4	170	20-30
Kidneys - Lamb/Pig	3	180	10-15
Liver - Lamb/Pig	3	180	20-30
Sausages	3	190	10-15
Steaks - Medium	3	220	8-10
Steaks - Well Done	3	220	each side 10-12 each side
Heating through and Browning e.g. au-gratin, lasagne, shepherd's pie	3	170	20-30 depends on size

NOTE: Shelf positions are counted from the bottom of the oven. Only use straight shelves when thermal grilling in the main oven.

The times quoted above are given as a guide and should be adjusted to suit personal taste.



USES OF OVEN CLEAN FEATURE

During normal use the Stayclean coating within the oven will become splashed with fats and food residues. When the oven clean feature is selected the Stayclean surfaces burn off any soilage. See Care of Stayclean Surfaces on page 44 for instructions. Regular use of the oven clean function will keep the Stayclean panels in good condition.

SELECTING OVEN CLEAN

BD 921

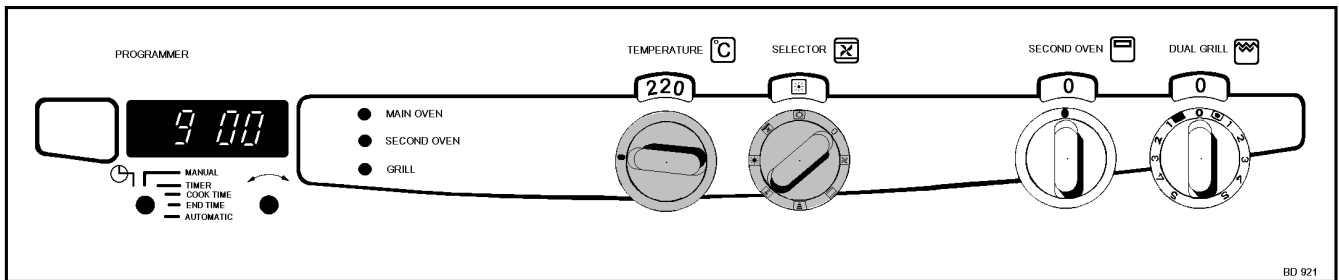

BD 931

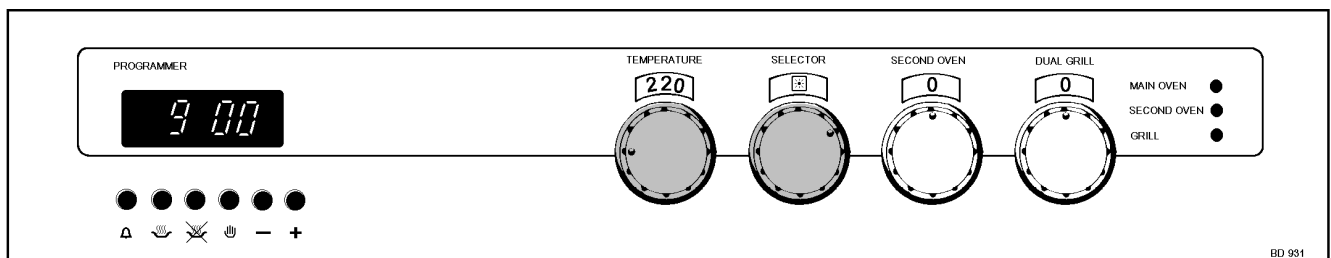

- Remove oven shelves and bakeware from oven.
- Turn the multifunction selector to oven clean.

- Turn the main oven temperature control to 220°C.

THINGS TO NOTE

1. The oven indicator neon will glow until the oven has reached the desired temperature and then go out. It will then cycle ON and OFF showing that the oven temperature is being maintained.
2. The selector and temperature control indicator windows will illuminate.
3. The internal oven light operates when the selector is set.
4. The control cooling fan will operate after a short time when oven clean is selected. See page 16 for more details on the operation of the cooling fan.

HINTS AND TIPS

- Manual cleaning of the Stayclean surfaces is NOT recommended.

Damage will occur if soap impregnated steel wool pads, aerosol cleaners or any abrasive cleaners are used.

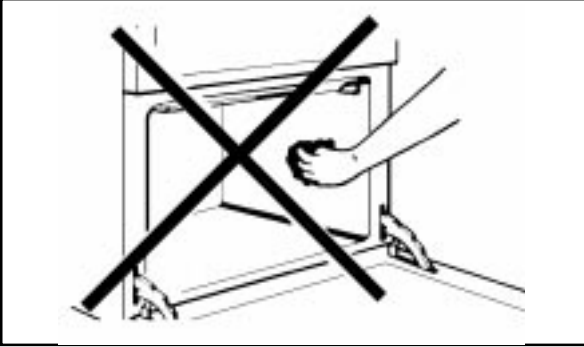

- Slight discolouration and polishing of the Stayclean surfaces may occur in time, but this will not affect their self cleaning properties.
- Use the oven clean function for an hour or two per week to avoid a build up of soilage which could prevent the stay clean enamel from working properly.
- A good time to use the oven clean function is after the weekly roast. Simply select oven clean function as described above and allow the oven to run for an hour or so.
- Surfaces which are not Stayclean coated e.g. the oven base, the oven exterior etc., will require manual cleaning. Refer to the Care and Cleaning Section on page 45 for details.
- Useful hints and tips are given on page 45 on how to keep soilage to a minimum.

THE ELECTRONIC TIMER (BD 921)

Key:



CLOCK

MANUAL

TIMER

COOK TIME

END TIME



COOKING SYMBOL



AUTOMATIC

A = SELECTOR

B = SETTING KNOB

THESE STEPS MUST BE FOLLOWED BEFORE THE COOKER WILL OPERATE MANUALLY

1. TO SET THE TIME OF DAY

When first switching ON, the display will flash 00.00 and cookpot (👉) symbol. See Fig. 1.

Turn and hold selector (A) to clock (🕒). Then turn setting knob (B) until the correct time of day is shown, e.g. 13.00 (1 pm). Release both knobs, the display will stop flashing and the cookpot (👉) symbol will glow. Fig. 2. Selector (A) will return to 'Manual'.

Note:

The clock will show the time of day as long as the oven is switched ON at the wall. The above steps must be followed every time the oven is switched OFF at the wall or if there has been a power failure.

2. TO SET THE MINUTE MINDER

Turn the selector (A) to 'Timer' 00.00 and the cookpot (👉) symbol will glow. Fig. 3.

Using setting knob (B), turn until the required period to be timed is shown e.g. 40 mins. Fig. 4.

The minute minder will count down in one minute intervals. To check the time of day, return the selector (A) to 'Manual'.

At the end of the timed period, the timer will sound. To stop the sound, turn setting knob (B). The display will show the time of day and the cooking symbol will remain lit. If the signal is not cancelled the timer will sound for up to 2 minutes. Fig.5.

A period of up to 23 hrs 59 mins can be timed.



AN OVEN FUNCTION MUST BE SELECTED BEFORE THE OVEN WILL OPERATE WITH THE AUTOMATIC TIMER

Fig.1



Fig.2

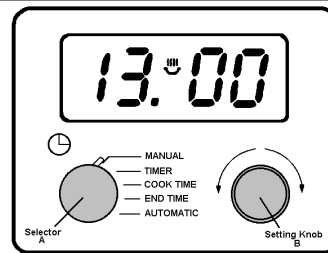

Fig.3

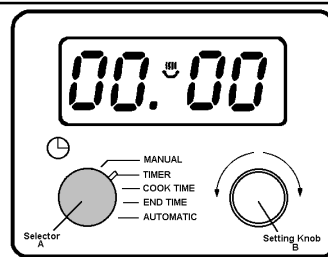

Fig.4

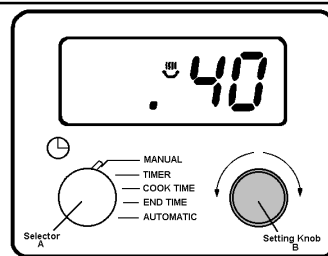
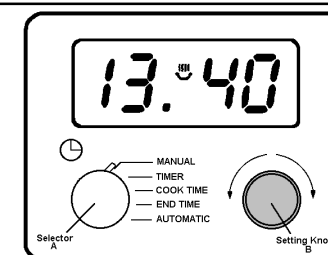

Fig.5



4. TO CANCEL THE MINUTE MINDER

Turn the selector (A) to 'Timer'.

Turn setting knob (B) until the display shows 00.00 The cookpot (👉) symbol will glow. Fig.6.

Turn selector (A) to manual. The time of day will show in the display.

4. HOW TO SET THE OVEN TIMER

When using the timer control for the first time, it is advisable to let it operate while you are at home. The displays can be checked to show that it is operating correctly and you will then feel confident to leave a meal to cook automatically in future.

A) TO SWITCH THE OVEN ON AND OFF AUTOMATICALLY

- i) Make sure the electricity supply is switched on. Set the correct time of day, e.g. 9.am Fig. 7.
- ii) Place food in oven.
- iii) Turn the selector (A) to 'Cook Time'. The display will show 00.00 and cookpot (👉) symbol. Turn setting knob (B) to the number of hours and minutes you wish the food to cook e.g. 2 hrs 30 mins. Fig 8.
- iv) The AUTO display and cookpot (👉) symbol will glow.
- v) Turn the selector (A) to 'End Time'. Turn setting knob (B) until the time you want the food to be cooked is visible, e.g. 18.00 hours (6 pm.) The cooking symbol will go out. Fig.9.
- vi) Turn the selector (A) to 'Automatic'. The display returns to show the time of day. The 'AUTO' symbol will remain lit.
- vii) Set the oven temperature required and multi-function selector.
- viii) The 'End Time' and 'Cook Time' can be checked at any time by turning the selector (A).
- ix) At the end of the cooking time an audible signal will sound. To cancel the alarm turn setting knob (B).
- x) Return the oven to manual mode by turning selector (A) to 'Manual'.

Fig.6

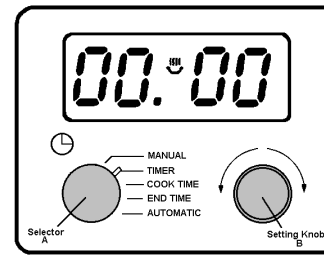

Fig.7



Fig.8

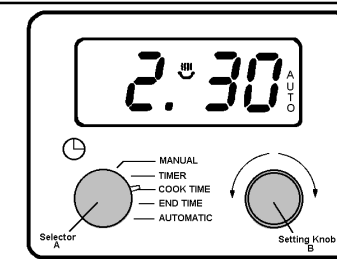
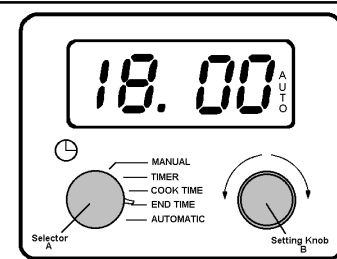

Fig.9



B) TO START COOKING NOW, THEN SWITCH OFF AUTOMATICALLY

Follow the first two points as A) above then:

iii) Turn the selector (A) to 'End Time'. The display will show 00.00 and the cookpot (☼) symbol will be lit. Turn setting knob (B) until the time is shown when you want the food to stop cooking e.g. 12.00 noon Fig. 10.

iv) The cookpot (☼) symbol will stay lit and the 'AUTO' symbol will glow.

v) Set the oven temperature and multifunction selector on the oven as required.

vi) You may leave the selector (A) at the 'End Time'. This will display the amount of cooking time remaining.

Alternatively, turn selector (A) to 'Automatic'. The time of day will appear in the display. Fig 11. At any time you can turn the selector (A) to 'End Time' to see the time remaining.

vii) At the end of the cooking time an audible signal will be heard.

viii) To cancel the signal, turn setting knob (B). The display will show 00.00 when the selector (A) is turned to 'Cook Time. Fig. 12. When the selector (A) is set at 'Automatic' the display will show time of day and the 'AUTO' symbol will flash.

ix) To return the oven to manual, turn the selector (A) to 'Manual'.

5. TO CANCEL AN AUTOMATIC PROGRAMME

Turn the selector (A) to 'Cook Time' and turn setting knob (B) until 00.00 shows in the display. The AUTO display will flash.

Return to 'Manual' by turning selector (A). The oven will now operate manually.

6. NOTES FOR AUTOMATIC COOKING

It is advisable to leave food in the oven for as short a time as possible before automatic cooking. Always ensure commercially prepared food is well within its use by date and that home prepared food is fresh and of good quality.

When cooking is complete, do not leave food to stand in the oven, but remove and cool it quickly if the food is not to be consumed immediately.

Always ensure food in the oven has been covered before cooking, if it is not possible to remove food immediately after cooking.

Fig.10

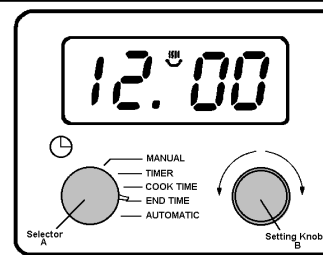

Fig.11

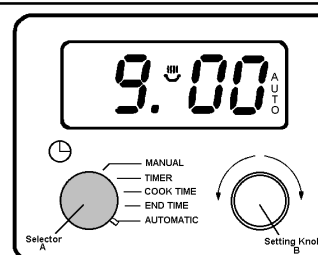
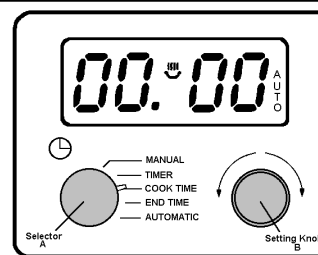

Fig.12



THE ELECTRONIC TIMER (BD 931)

KEY

- A AUTO DISPLAY
- B MINUTE MINDER BUTTON
- C COOKING HOURS BUTTON
- D STOP TIME BUTTON
- E COOKING SYMBOL
- F MANUAL SELECTOR BUTTON
- G DECREASE CONTROL
- H INCREASE CONTROL

NOTE:

Steps 1 and 2 below must be completed before the oven will operate manually.

1. SET THE TIME OF DAY

When the electricity supply is first switched ON, the display will flash both 0.00 and AUTO as Fig. 1.

Press the two buttons marked (☀) and (☁) press the increase control button (+) and if necessary, the decrease control button (-) until the correct time on the 24 hour clock is reached, e.g. 10.00am as Fig. 2.

Note: The increase and decrease control buttons operate slowly at first, and then more rapidly. They should be pressed separately.

The AUTO symbol will go out when the correct time of day is set as Fig. 2.

2. THE MINUTE MINDER

The minute minder gives an audible reminder at the end of any period of cooking up to 23 hrs 59 mins. It is not part of the automatic control.

To set, press the minute minder button (🔔) and the digital display will read 0.00 and the bell symbol will glow.

Depress the increase control (+) until the display indicates the interval to be timed, e.g. 1hr 45 mins as Fig. 4. If necessary depress the decrease control (-) to achieve the correct time interval.

NOTE: This must be completed within 4 seconds of first pressing the minute minder button.

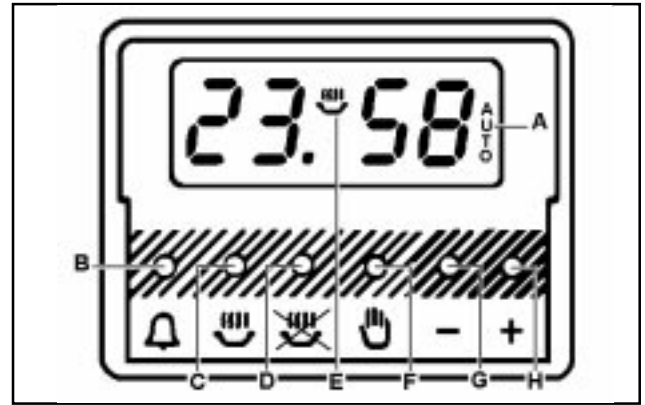

Fig. 1

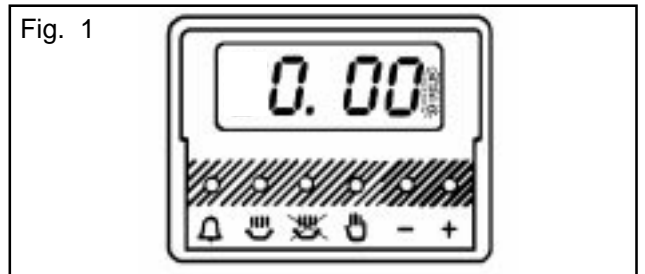

Fig. 2

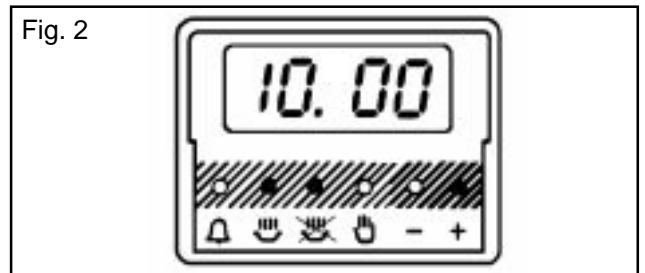

Fig. 3

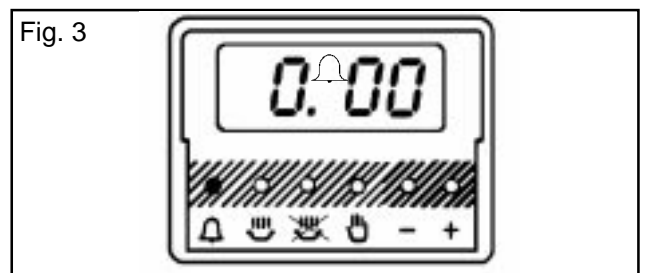
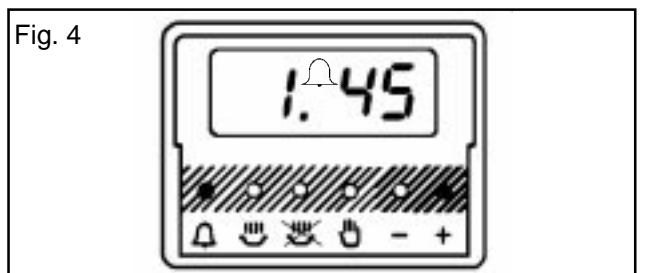

Fig. 4



Release the minute minder button and the display will return to the time of day after 5 seconds.

During the operation of the minute minder, the remaining time period can be shown in the display by pressing the minute minder button (🔔) as Fig. 5.

The minute minder will sound intermittently for up to 2 minutes and the bell symbol will flash at the end of the timed period. The sound can be stopped by pressing any of the 4 left hand side buttons.

3. HOW TO SET THE OVEN TIMER CONTROL

When using the timer control for the very first time, it is advisable to let it operate while you are at home. The displays can be checked to show that it is operating correctly and you will feel confident to leave a meal to cook automatically in the future.

A) TO SET THE TIMER TO SWITCH ON AND OFF AUTOMATICALLY

- i) Ensure the electricity supply is switched ON and that the correct time of day is displayed, e.g. 9.a.m. as Fig. 6.
- ii) Place food in oven.
- iii) To set the length of cooking time, press the cooking hours button (🕒) press the increase control (+) until the required length of cooking time is displayed, e.g. 2 hrs 15 mins as Fig. 7. If necessary depress the decrease control (-) until the correct time interval is achieved.
- iv) Release the buttons. The AUTO display and cooking symbols will glow.

Remember, this must be completed within 4 seconds of first pressing the cooking hours button.

- v) Set the STOP time. Press the stop time button (🕒), press the increase control (+) until the required stop time is displayed, e.g. 12.15p.m. as Fig. 8. If necessary depress the decrease control (-) until the correct time interval is achieved.
- vi) Release the buttons. The cooking symbol will go out and the time of day will be displayed after 5 seconds.

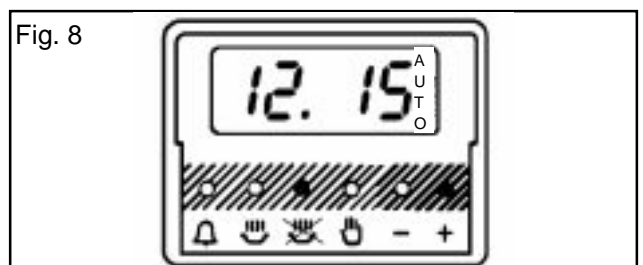
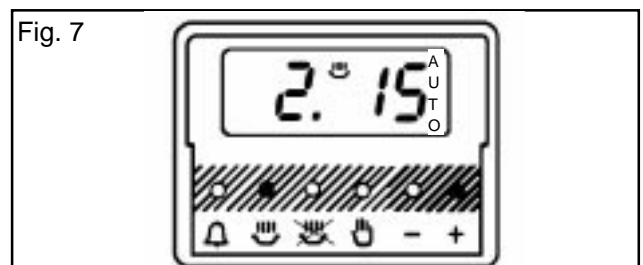
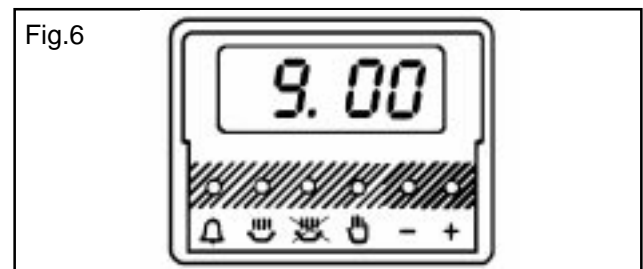
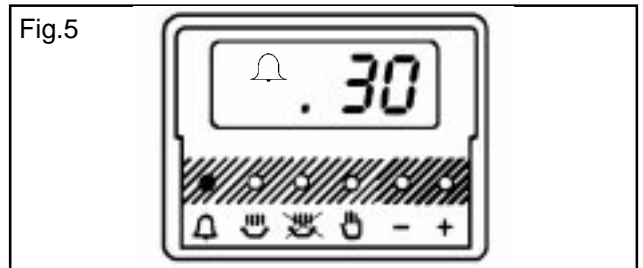

- vii) Set the oven control to the required temperature and select the required function. The oven indicator neon should be OFF and the AUTO display will glow.

Note: When the automatic timed period starts, the oven indicator neon will cycle ON and OFF during cooking.

B) TO SET THE TIMER TO SWITCH OFF ONLY

- i) Ensure the electricity supply is switched ON and that the correct time of day is displayed, e.g. 10.00am as Fig. 9.
- ii) Place food in oven.
- iii) To set the length of cooking time, press the cooking hours button (🕒), depress the increase control (+) until the required length of cooking time is displayed, e.g. 2 hrs 15 mins as Fig. 10. Depress the decrease control (-) if necessary.
- iv) Release the buttons. The AUTO display will glow and the time of day will be displayed after 5 seconds.
- v) Set the oven temperature. The oven indicator neon should be ON.
- vi) To check the stop time during the cooking period, simply press the stop time button (🕒) and the stop time will be displayed, as Fig. 11.

4 TO RETURN THE COOKER TO MANUAL OR TO CANCEL AN AUTOMATIC PROGRAMME

To cancel an automatic programme, or return the cooker to manual operation, follow the steps given below.

At the end of a timed cooking period, the AUTO light will flash and a bleeper will sound for up to 2 minutes. This can be stopped by pressing any of the 4 left hand side buttons as Fig. 12.

Turn oven control to the OFF position. The AUTO display will continue to flash .

Press (👉) button. The AUTO display will go out. Fig.13.

Turn the multifunction selector and oven control ON to check that the oven operates manually. The oven indicator neon will glow.

Turn all oven controls OFF. No indicator neons should be displayed.

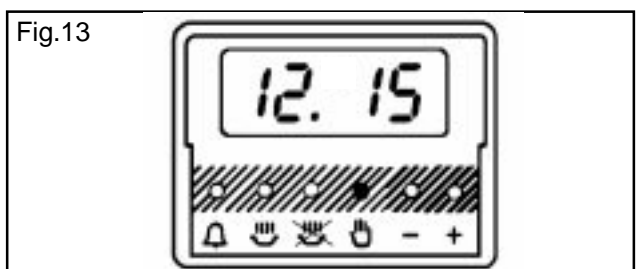
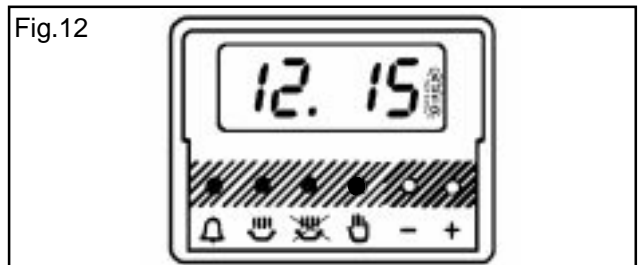
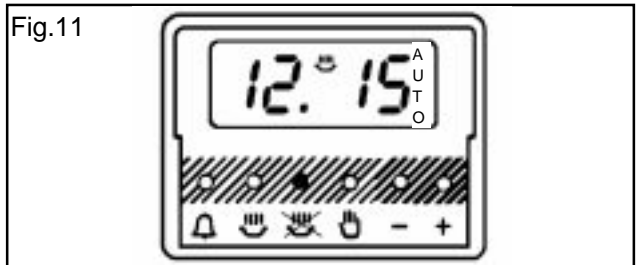
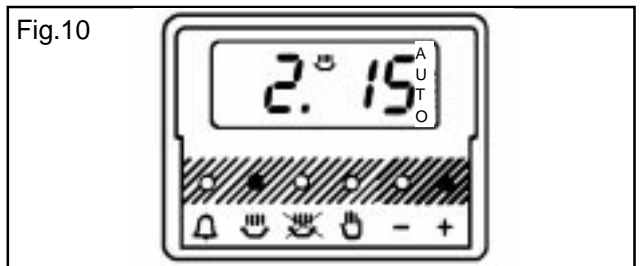
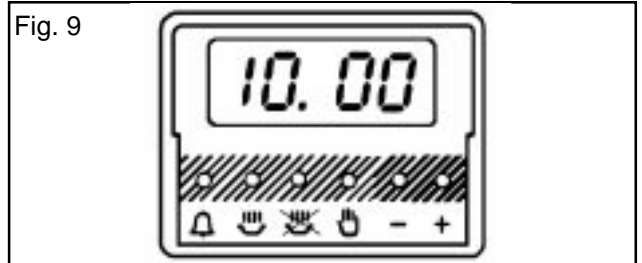

5. THINGS TO NOTE

The time of day cannot be altered whilst the AUTO symbol is lit.

During the hours of 10 p.m. (22.00 hrs) and 6 a.m. the display will glow dim. If a function is selected the display will glow brighter until the function is complete. It will then revert back to the dim mode.

A programme may be cancelled by returning the cooking hours to zero. Press the cooking hours button () press (-) button until 0.00 is displayed as Fig. 14.

Release all buttons. The AUTO display will now flash and acts as a reminder to reset the cooker to manual.

In the event of an interruption of the electricity supply, the timer will reset itself to zero, and all programming will be cancelled.

6. AUTOMATIC COOKING

It is advisable to leave food in the oven for as short a time as possible before automatic cooking. Always ensure commercially prepared food is well within its use by date and that home prepared food is fresh and of good quality.

When cooking is complete, do not leave food to stand in the oven, but remove and cool it quickly if the food is not to be consumed immediately.

Always ensure food in the oven has been covered before cooking if it is not possible to remove food immediately after cooking.

Fig.14



HELPFUL HINTS WHEN BUYING AND PREPARING FOOD

Care must be taken when handling foods in the home. Always follow the basic rules of food hygiene to prevent bacterial and microbial growth and cross contamination when preparing, reheating, cooking, cooling, defrosting and freezing foods.

1. Always ensure food you purchase is of good quality and in prime condition. Shop at a reliable source and buy the 'freshest' looking package - avoid shop worn labels or produce covered in dust.
2. Avoid buying chilled or frozen products if you cannot store them straight away. The use of an insulated container when shopping is advisable.
3. Buy and consume foods prior to the 'Sell by' or 'Best Before' date.
4. When you arrive home, place perishable foods in the refrigerator or freezer immediately. Ensure they are well covered to prevent them drying out and to prevent any possible cross contamination with bacteria from raw to cooked foods.
5. Follow the cooking instructions on packets of prepacked and cook chill foods, but be prepared adjust cooking times and temperatures to suit your particular oven. For example, the Fan Oven generally requires 20-25°C lower temperature than Conventional Oven.
6. Always ensure that cook chill foods are thoroughly reheated until they are piping hot throughout.
7. It is preferable to defrost frozen foods slowly in the refrigerator. Alternatively, a microwave cooker or the Defrost function on your oven may be used.
8. Always cook defrosted foods immediately after thawing. Thawed food should never be refrozen.
9. Joints of meat and poultry should be thoroughly defrosted before cooking.

10. Cook meat thoroughly - use a meat thermometer if preferred, which penetrates the joint to check that the centre temperature has reached the required temperature (see table below)

MEAT	TEMPERATURES
Beef	Rare - 60°C Medium - 70°C Well Done - 80°C
Pork	Well Done - 80°C
Lamb	Medium - 70°C Well Done - 80°C

11. If not eaten straight away after cooking, food should be cooled as quickly as possible (within one hour) and then refrigerated or frozen as required. **Do not** put hot food into a refrigerator or freezer.
12. In the kitchen keep worktops, chopping boards and utensils clean with hot soapy water between preparation stages. Ideally, keep one chopping board for raw meat and another for other foods. Keep your dish cloths and tea towels clean.

CARE AND CLEANING

BEFORE CLEANING THE COOKER ALWAYS ALLOW THE COOLING FAN TO COOL THE COOKER DOWN BEFORE SWITCHING OFF THE ELECTRICITY SUPPLY.

CLEANING MATERIALS

Before using any cleaning materials on your cooker, check that they are suitable and that their use is recommended by the manufacturer.

Cleaners that contain bleach should NOT be used as they may dull the surface finishes. Harsh abrasives should also be avoided.

CLEANING THE OUTSIDE OF THE COOKER

DO NOT use abrasive cleaning materials or scourers on the outside of the cooker as some of the finishes are painted and damage may occur. Regularly wipe over the control panel and oven doors using a soft cloth well wrung out in warm water to which a little liquid detergent has been added.

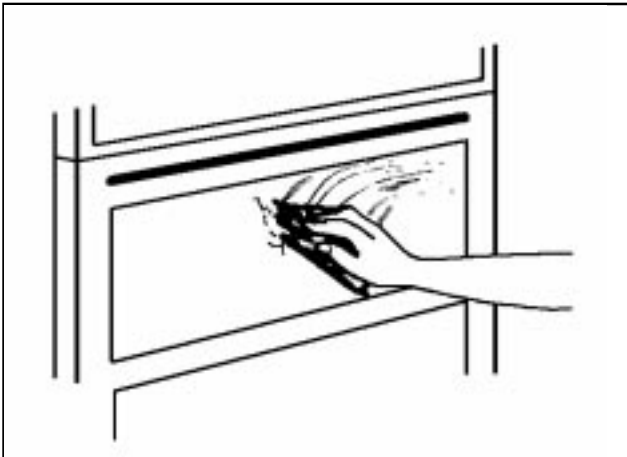

DO NOT ATTEMPT TO REMOVE ANY OF THE CONTROL KNOBS FROM THE PANEL AS THIS MAY CAUSE DAMAGE AND IS A SAFETY HAZARD.

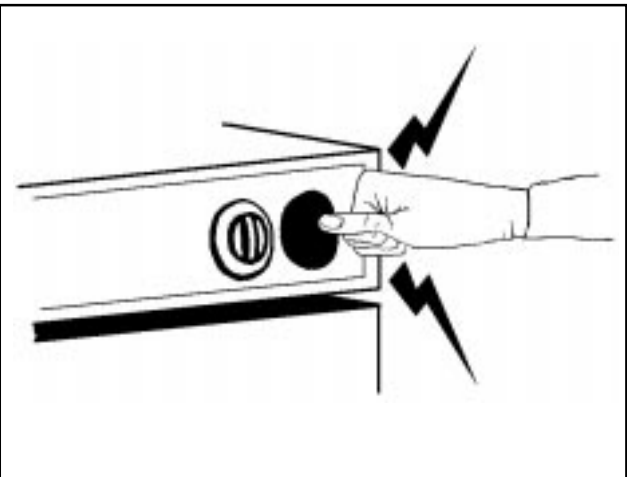

CLEANING BETWEEN THE OUTER AND INNER DOOR GLASS

The outer door glass is removable for cleaning.

TO REMOVE THE OUTER GLASS

1. Open the oven door slightly to gain access to the two cross head screws on the top of the oven door.
2. Loosen the two screws using a Pozidrive screwdriver.
3. Hold the door glass securely in place with one hand before removing the screws completely with the other hand.
4. Using both hands, gently tilt the top of the door glass towards you. Lift slightly to disengage the locators from the two bottom brackets.

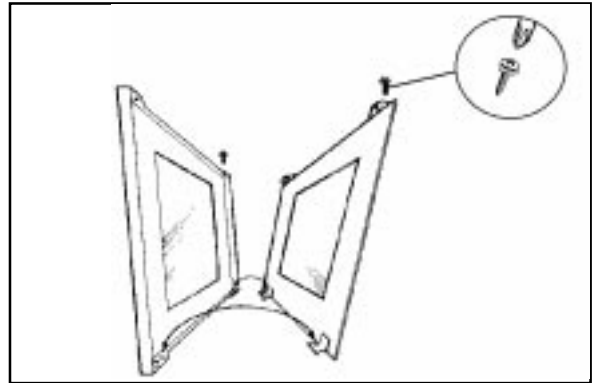

5. Clean the outer and inner glass using hot soapy water or Flash Cream cleaner. Should the inner face of the outer door glass be heavily soiled it is recommended that soapy water with a high concentration of soap is used. To prevent streaking a glass cleaning spray may be applied and the glass polished with a soft cloth. DO NOT try to clean the aluminium foil which is inside the door. The foil is there to help keep the door cool, if it is damaged it will not work. Ensure that all parts are well rinsed and thoroughly dry before attempting to replace the outer door glass.

TO REPLACE THE OUTER GLASS

1. Holding the oven glass with both hands, gently place the locators into the holes of the brackets at the bottom of the oven door.
2. Push the top of the oven glass towards the oven door, ensuring the screw location holes line up.
3. Hold the glass in place with one hand and insert the cross head screws into the location holes with the other hand. Give the screws one turn to ensure the glass is secure.
4. Tighten the screws positively with a Pozidrive screwdriver before closing the oven door.

DO NOT attempt to use the oven without the glass being in place.

TO CLEAN INSIDE THE INNER GLASS DOOR

The inner glass door is not removable. Clean using hot soapy water or Flash Cream Cleaner and a soft cloth. Take care NOT to use abrasives as they may damage the glass or seal.

CLEANING INSIDE THE OVENS

The Stayclean surface inside the ovens should not be cleaned manually. See 'Care of Stayclean Surfaces'.

The vitreous enamel oven base can be cleaned using normal oven cleaners or aerosol oven cleaners with care. Ensure that the manufacturers instructions are followed and that all parts are well rinsed afterwards.

Aerosol cleaners must not be used on Stayclean surfaces and must not come into contact with the elements or the door seal as this may cause damage.

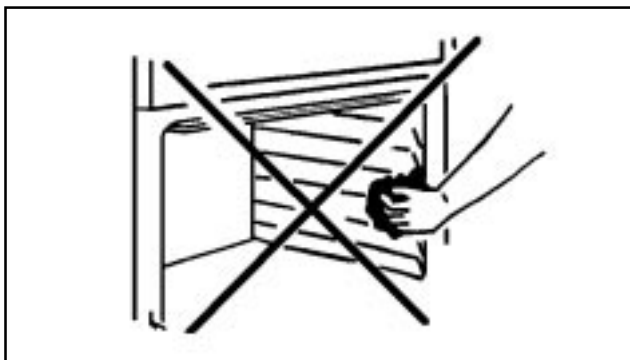

The grill deflector is removable for easy cleaning. Thorough cleaning with a soap impregnated steel wool pad is recommended.

CLEANING THE OVEN SHELVES AND GRILL/OVEN FURNITURE

Soak the oven shelves and grilling grid in hot soapy water if heavily soiled, they will then clean more easily.

The grill pan, meat tin and trivet can be cleaned using a soap impregnated steel wool pad.

All the above items of grill/oven furniture are dishwasher safe.

NOTE: The grill pan handle should not be cleaned in the dishwasher.

CARE OF STAYCLEAN SURFACES

Stayclean surfaces destroy splashes of food and fats when the oven temperature is raised to around 220°C.

To aid this process it is a good idea to run the oven for an hour or two per week without food, to ensure continued good performance from the Stayclean finish.

HINTS AND TIPS

- Manual cleaning of Stayclean is not recommended. Damage will occur if soap impregnated steel wool pads, aerosol cleaners and any other abrasives are used.
- Slight discolouration and polishing of the Stayclean surface may occur in time. This does not affect the Stayclean properties in any way.
- Follow the recommendations below to keep oven soilage to a minimum.

COOKING TO REDUCE SOILAGE

1. Cook at the recommended temperatures. Higher temperatures during roasting will increase soilage. Try cooking at lower temperatures for an increased length of time, you will save energy and often the joint is more tender.
2. Use minimal, if any, extra oil or fat when roasting meat, potatoes only require brushing with fat before cooking. Extra fat in the oven during roasting will increase splashing and soilage.
3. It is NOT necessary to add water to the meat tin when roasting. The water and the fat juices from the joint create excessive splattering during cooking, even at normal temperatures, as well as causing condensation.
4. Covering joints during cooking will also prevent splashing onto the interior surfaces. Removing the covering for the last 20-30 minutes will allow extra browning if required. Some large joints and turkeys especially benefit by this method of cooking, allowing the joint to cook through before the outside is overbrowned.

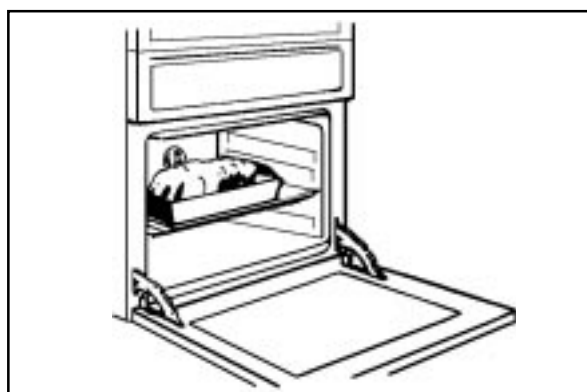

5. **Do use** the trivet in the roasting tin. During roasting the fat from the joint will be contained beneath the trivet and therefore prevent it from splattering onto the 'Stayclean' finish.

REPLACING THE OVEN LIGHT BULB

The type of bulb required is a 300C 25 watt small Edison Screw. Part number 572 491 5431-00/1. (Available through Tricity Bendix service centres).

CAUTION: DISCONNECT THE COOKER FROM THE ELECTRICITY SUPPLY BEFORE REPLACING THE BULB.

Open the oven door and remove the shelves to enable easy access to the oven light assembly.

Insert a flat blade screwdriver between the oven side and the glass which covers the bulb. Support the glass with your hand and prise out sufficiently to release the glass cover. Unscrew the bulb in an anticlockwise direction until it is possible to remove the bulb with ease.

Fit the new bulb by turning in a clockwise direction until it is secure. Ensuring the indent to the flange is pointing to the rear of the oven, replace the glass by pushing it firmly into the hole to cover the bulb assembly.

Replace the shelves. Restore the electricity supply and adjust the time of day as necessary.

SOMETHING NOT WORKING?

We strongly recommend that you carry out the following checks on your cooker before calling a Service Engineer. It may be that the problem is a simple one which you can solve yourself without the expense of a service call.

If our Service Engineer finds that the problem is listed below you will be charged for the call whether or not the cooker is under guarantee.

The grill, oven and timer do not work.

- Check that the cooker has been wired in and is switched on at the wall.
- Check that the main cooker fuse is working.
- Check that the timer is set to manual (see pages 36 and 39).

If you have checked the above:

- * Switch OFF cooker at the wall and allow the appliance to cool for a couple of hours. Switch ON again. The cooker should now be working normally.

The grill works but the oven does not:

- * Check that the timer is set to manual operation (see pages 36 and 39).
- * Check that the grill control is in the OFF position.
- * If you have checked that the timer is set for manual switch OFF at the wall to allow the oven to cool. After a couple of hours the oven should be working normally.

The second oven and grill work but the main oven does not.

- * Check that the timer is set for manual operation. See pages 36 and 39.
- * For second ovens check that the grill control is in the OFF position.
- * If you have checked the timer is set to manual switch OFF at the wall to allow oven to cool. Check that the oven is now working normally.

The timer control does not work.

- * Check that the operating instructions are being closely followed. See pages 36 and 39.

The grill does not work or cuts out after being used for a long period of time.

- * Leave the oven to cool for a couple of hours. Check that the grill operates normally. Ensure that the door is left open during grilling.
- * If the cooling fan fails, the grill will not work. Please contact your Customer Service Centre.

The oven temperature is too high or low:

- * Check that the recommended temperatures are being used (see page 30). Be prepared to adjust up or down by 10° C to achieve the results you want.
- * Care should be taken if using an oven thermometer to check oven temperatures as they may be inaccurate.

The following factors should be considered.

- * Ensure you purchase an accurate good quality instrument.
- * Ovens will cycle about a set temperature and will not be constant.

If the oven is not cooking evenly.

- * Check that the cooker is correctly installed and that it is level.
- * Check that the recommended temperatures and shelf positions are being used.

The oven light fails to illuminate:

- * Refer to page 46 'Replacing the Oven Light Bulb'.

The oven fan is noisy:

- * Check that the oven is level.
- * Check that bakeware and shelves are not vibrating in contact with the back panel in the oven.

The indicator neons are not working correctly or the function selected is not working.

- * Check that you have correctly selected only the oven function you require. Ensure all the other controls are in the OFF 'O' position.

NB. If the selector is set to 'O' and the oven temperature control to a setting the main oven neon will illuminate and the cooling fan will operate. This is not a fault.

SERVICE AND SPARE PARTS

HELP US TO HELP YOU

Please determine your type of enquiry before writing or telephoning.

SERVICE

It is a recommendation by the manufacturer that annual servicing of the product is done by the manufacturers approved service organisation.

In the event of your appliance requiring service Tricity Bendix have an arrangement with Electrolux Group Service.

Before calling out an Engineer, please ensure that you have read the details under the heading 'Something Not Working?' and have the model number and purchase date to hand. The model and serial numbers, which should be quoted in any communication can be found on the rating plate on the lower front frame of the cooker upon opening the oven door. It is advisable to make a note on the back cover of this book for easy reference. The telephone number and address for service is detailed on the list headed 'Customer Service Centres'.

PLEASE NOTE that all enquiries concerning service should be addressed to your local Customer Service Centre.

CONSUMER CARE DEPARTMENT

FOR GENERAL ENQUIRIES concerning your Tricity Bendix cooker or further information on Cooking, Cooling or Washing products, you are invited to contact our Consumer Care Department by letter or telephone as follows:

Consumer Care Department
Tricity Bendix Limited
99 Oakley Road
Luton
Bedfordshire LU4 9QQ
Tel: (01582) 585858

CUSTOMER SERVICE CENTRES

The Regional Electricity Companies are responsible for the servicing of cookers sold by their own outlets. The telephone numbers can be found in the telephone directory.

Service for cookers bought from other outlets can be obtained by calling the nearest Customer Service Centre on the numbers given below. The areas are defined by Postcode for easy reference.

CENTRE	POSTAL DISTRICTS	SERVICE APPOINTMENTS	ADDRESS
ABERDEEN	AB	01224-696569	Electrolux After Sales Service Northeast Appliance Service 8 Cornhill Arcade Cornhill Drive Aberdeen AB2 5UT
ARGYLL	PA 24-61	01369-703161	Electrolux After Sales Service T.D.C. Refrigeration Briar Hill 7 Hill Street Dunoon Argyll PA23 7AL
BARNSTAPLE	EX18-23, 31-39	01271-328826	Electrolux After Sales Service McBain Refrigeration Unit 4 Upcott Avenue Pottington Industrial Estate Barnstaple N.Devon EX31 1HN
BORDERS	TD	01573-224411	Electrolux After Sales Service James Stewart & Son 2-8 Wood Market Kelso Borders TD5 7AX
BRISTOL	BA BS TA SP	0117-9211876	Electrolux After Sales Service Unit BE46 PO Box 372 Bristol BS99 1UD
CANVEY	E EC EN N NW W WC AL CB HA HP LU MK SG UB WD CM CO IG RM SS IP NR PE14-19,30-38	0181-443-3464 0181-965-9699 0181-965-9699 01268-694144 01603-667017	Electrolux After Sales Service 2-4 Sandhurst Kings Road Canvey Island SS8 0QY
CARDIFF	CF NP1-4, 6, 9-44,SA1-18 SA21-32	01222-460131	Electrolux After Sales Service Guardian Industrial Estate Clydesmuir Road Tremorfa Cardiff CF2 2QS
CUMBRIA	CA	01228-594747	Electrolux After Sales Service E.T.B. Services Carlisle Enterprise Centre James Street Carlisle CA2 5AP
DUMFRIES & GALLOWAY	DG1-14	01387-265166	Electrolux After Sales Service Allan Crossan (Service) 93 Irish Street Dumfries Scotland
DUNDEE	Parkinson Cowan Gas Only	01382-642828	Electrolux After Sales Service Tayside Refrigeration 3-7 Blackness Street Dundee DD1 5LR
DUNDEE	DD1-14 PH8-18	01250-876285	Electrolux After Sales Service 1 Brogan Domestic 41 Leslie Street Blairgowrie Perthshire PH10 6AT

GLASGOW	EH FK G KA KY1-16 ML PA1-23, PH1-7	0141-647-4381	Electrolux After Sales Service 20 Cunningham Road Clyde Estate Rutherglen Glasgow G73 1PP
GUERNSEY	All Codes	01481-46931	Guernsey Electricity PO Box 4 Vale Guernsey Channel Islands
HAVERFORDWEST	SA33-39 SA41-44 SA61-73	01437-710914	Electrolux After Sales Service C Butherway 1 Church Road. Roch Haverfordwest Dyfed Wales SA62 6AG
HEREFORD	HR1-9 LD1-8 SY7 ,18 NP5 NP7-8	01432-340334	Electrolux After Sales Service Domestic Repair Centre Unit 3 Bank Buildings Cattle Market Hereford HR4 9HX
HULL	YO4 YO11-18 YO25 HU1-19 DN14	01482-585678	Electrolux After Sales Service John Sizer Unit 1 Boulevard Unit Factory Estate Hull HU3 4AY
INVERNESS	IV1-28, 30-36, 52-56, PH19-26, 42-44 KW1-14	01463-792952	Electrolux After Sales Service Highland Appliances Unit 3B3 Smithton Industrial Est Smithton Inverness
INVERNESS	PH30-41 IV40-51	01855-821315	Electrolux After Sales Service George Ross Electrical Forrestry Workshop Inchree Onich Inverness-shire PH33 6SE
ISLE OF WIGHT	PO30-41	01983-872552	Electrolux After Sales Service Wyatts Electrical Service 4 Forelands Road Bembridge Isle of Wight PO35 5XW
ISLE OF ARRAN	KA27	01770-302909	Electrolux After Sales Service Arran Domestic Unit 4 The Douglas Centre Brodick Isle of Arran KA27 8AJ
ISLE OF MAN	IM	01624-663455	Electrolux After Sales Service Manx Electricity Service Workshop North Quay Douglas Isle of Man
ISLE OF MULL	PA62-75	01688-302262	Electrolux After Sales Service B Hogg Braeside Raeric Road Tobermory Isle of Mull PA75 6PU
JERSEY	ALL CODES	01534-505050	Jersey Electricity Company PO Box 45 Queens Road St Helier Jersey, Channel Islands JE4 8NY
LAMPETER	SA19,20 SA40 SA45-48 SY23-25	01570-423020	Electrolux After Sales Service Lampeter Domestic Appl. Services Unit 16 Lampeter Ind. Est. Lampeter SA48 7DY

LANCASTER	LA1-23	01772-316175	Electrolux After Sales Service NL Services Unit 333 Ranglet Road Walton Summit Bamber Bridge Preston, Lancashire PR5 8AR
LEEDS	BD DN1-7, 10-12, HD HG HX LS S WF YO1-3, 5-8 DE NG1-22 & 25	0113-2608511	Electrolux After Sales Service 64-66 Cross Gates Road Leeds LS15 7NN
LINCOLN	DN21 sub codes 1 2 & 5 only, LN1, 2, 4,5,6 LN3 sub codes 4 & 5 only LN8-10 NG 23,24 31-34 PE1-13, 20-25	01522-514603	Electrolux After Sales Service Brian Hudson Unit 8 Stonefield Park Clifton Street Lincoln LN5 8AA
LIVERPOOL	FY PR L WN CH CW WA (Not WA 14/15)	0151-2541724	Electrolux After Sales Service Unit 1 Honeys Green Precinct Honeys Green Lane West Derby Liverpool L12 9JH
MANCHESTER	BB BL OL M SK WA14 & 15 only	0161-4777758	Electrolux After Sales Service Unit 30 Oakhill Trading Estate Devonshire Road Worsley Manchester M28 3PT
NEWTON ABBOTT	EX1-17 TQ PL1-9, 16, 19-21	01626-65909	Electrolux After Sales Service South West Domestic Service Unit 2 Zealley Industrial Est Kingsteignton Newton Abbott South Devon TQ12 3SJ
NORTH WALES	LL	01745-591616	Electrolux After Sales Service GMS (Cymru) Unit 2 Coed- Parc Abergele Road Rhuddlan Clwyd, Wales LL18 5UG
NORTHERN	DL TS DH YO21, 22 DH NE SR	01325-301400 0191-493-2025	Electrolux After Sales Service PO Box 40 Preston Road Aycliffe Industrial Estate Newton Aycliffe, Co Durham DL5 6XA
NORTHERN IRELAND EAST	BT1-30, 36-57, 63-67	01232-746591	Electrolux After Sales Service Unit C3 Edenderry Industrial Estate 326 Crumlin Road Belfast BT14 7EE
NORTHERN IRELAND WEST	BT31-35, 60-62, 68-82, 92-94	01861-510400	Electrolux After Sales Service G & O (Armagh) Service Owenmore House Kilwee Business Park Upper Dunmurray Lane Belfast BT17 0HD
NUNEATON	B DY ST TF WR WS WV GL NN OX SN CV LE	0121-358-7076 0121-358-5051 01993-704411 01203-350420	Electrolux After Sales Service Unit 23-24 Alliance Business Pk Townsend Drive Nuneaton Warwickshire CV11 6RX
ORKNEY	KW15-17	01856-875457	Electrolux After Sales Service Refrigeration Sales and Services Hatson Ind. Estate Kirkwall Orkney
REDDITCH	TBA	TBA	Electrolux After Sales Service Heming Road Washford Redditch Worcestershire B98 ODH

REDRUTH	TR1-20, 26, 27 PL10-15, 17, 18, 22-35	01209-314407	Electrolux After Sales Service Cornwall Domestic Service Unit 7D Pool Industrial Estate Wilson Way Redruth Cornwall TR15 3QW
ROTHSAY	PA20	01700-504777	Electrolux After Sales Service D McGlashan Walker Walker Engineering Glenmhor Upper Serpentine Rothesay PA20
SHETLAND	Own Sales	01595-692225	Electrolux After Sales Service Tait Electronic Systems Ltd. Holmsgarth Road Lerwick Shetland ZE1 OPW
SHETLAND	Own Sales	01595-692855	Electrolux After Sales Service Bolts Shetland Ltd. 26 North Road Lerwick Shetland ZE1 OPE
SHETLAND	ZE2	01806-566546	Electrolux After Sales Service Leask Electrical Harsdale Symbister Shetland ZE2 9AA
SHREWSBURY	SY1-6 SY8-17 SY19-22	01743-450279	Electrolux After Sales Service BLI Service 6 Harlescott Barn Harlescott Lane Shrewsbury SY1 3SY
SOUTH COAST	BN16-18. GU27-35 PO1-22. BH DT SO TR21-25	01705-667411 01705-667411 0117-9211876	Electrolux After Sales Service Limberline Road Hilsea Portsmouth Hampshire PO3 5JJ
SOUTH HUMBERSIDE	DN 8, 9, DN15-20 DN21 sub codes 3,4 only DN31-40 LN (3 sub code 6 only), 7 LN11-13	01472-267978	Electrolux After Sales Service John Robinson (Electrical) Unit 74 New Enterprise Centre King Edward Street Great Grimsby DN31 3JP
TONBRIDGE	SL GU1-26. RG CT DA ME TN BN1-15, 20-27, RH TW BR CR SE SW SM KT	01252-24505 01732-357722 01273-694341 0181-658-9069	Electrolux After Sales Service Unit 30 Deacon Trading Estate Morley Road Tonbridge Kent TN9 1RA

We, Tricity Bendix, undertake that if within 12 months of the date of the purchase this Tricity Bendix appliance or any part thereof is proved to be defective by reason only of faulty workmanship or materials, we will, at our option repair or replace the same FREE OF ANY CHARGE for labour, materials or carriage on condition that:

- The appliance has been correctly installed and used only on the electricity supply stated on the rating plate.
- The appliance has been used for normal domestic purposes only and in accordance with the manufacturers operating and maintenance instructions.
- The appliance has not been serviced, maintained, repaired, taken apart or tampered with by any person not authorised by us. Any servicing or repairs carried out by any unapproved third party will invalidate the approvals status of this product.
- All service work under this guarantee must be undertaken by a Tricity Bendix service representative or authorised agent.
- Any appliance or defective part replaced shall become the Company's property.
- This guarantee is in addition to your statutory and other legal rights.

EXCLUSIONS

This guarantee does not cover:

- Damage or calls resulting from transportation, improper use or neglect, the replacement of any light bulbs or removable parts of glass or plastic.
- Cost incurred for calls to put right an appliance which is improperly installed or calls to appliances outside the United Kingdom.
- Appliances found to be in use within a commercial environment, plus those which are subject to rental agreements.
- Products of Tricity Bendix manufacture which are not marketed by Tricity Bendix.
- EEC Countries. The standard guarantee is applicable but subject to the owners responsibility and cost to ensure the appliance meets the standards set by the Country of which the product is taken. Electrolux Aftersales Service in the Country concerned, with whom Tricity Bendix have an arrangement, will be pleased to advise further.

RATING PLATE REFERENCE

MAKE AND MODEL NO.	SERIAL NO.	DATE OF PURCHASE

IMPORTANT NOTICE

In line with our continuing policy of research and development, we reserve the right to alter models and specifications without prior notice.

This handbook is accurate at the date of printing, but will be superseded and should be disregarded if specifications or appearance are changed.

TRICITY BENDIX

Better Products. Better Value.

TRICITY BENDIX, 99 OAKLEY ROAD, LUTON, BEDFORDSHIRE, LU4 9QQ

A Division of Emaco Limited . Registered in England No. 176547 . Registered Office. 101 Oakley Road, Luton LU4 9RJ.

MODEL NO.
BD 921/BD 931



PART NO.
311245708

Free Manuals Download Website

<http://myh66.com>

<http://usermanuals.us>

<http://www.somanuals.com>

<http://www.4manuals.cc>

<http://www.manual-lib.com>

<http://www.404manual.com>

<http://www.luxmanual.com>

<http://aubethermostatmanual.com>

Golf course search by state

<http://golfingnear.com>

Email search by domain

<http://emailbydomain.com>

Auto manuals search

<http://auto.somanuals.com>

TV manuals search

<http://tv.somanuals.com>