

# TRICITY BENDIX

Better Products. Better Value.



900 mm Built In Oven

## OPERATING AND INSTALLATION INSTRUCTIONS

MODEL NO.  
**DORSET/ DEVON**

## TECHNICAL DETAILS

**MODEL NO. ATB 4411/4421 DORSET**  
**ATB 4511/4521 DEVON**

Voltage: 230/240 Volts AC 50Hz  
Wattage: 5.0/5.4kW  
Height: 885mm  
Width: 595mm  
Depth: 545mm  
(excluding handles and knobs)  
Weight: 53kg

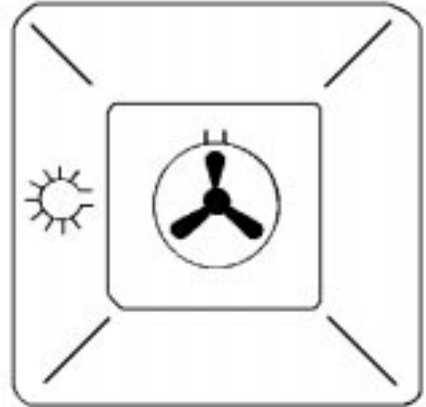

These appliances comply with: European Council Directive 73/23/EEC.  
EMC Directive 89/336/EEC.  
CE Marking Directive 93/68/EEC.

# CONTENTS

Please follow these instructions step by step to install and operate your oven safely and easily.

<b>Technical Details</b> .....	2
<b>Contents</b> .....	3
<b>Preface</b> .....	5
<b>Safety</b> .....	6
Before Installation .....	6
During Operation .....	6
After Use .....	7
General .....	7
<b>Installation Instructions</b> .....	8
Things You Need to Know .....	8
Warnings .....	8
Things to Note .....	8
<b>Getting Things Ready</b> .....	8
Choice of Electrical Connection .....	8
Preparing Cabinet for Fitting Oven .....	9
Recommended Cabinet Dimensions .....	10
How to Finish Unpacking .....	11
Tools Required .....	11
<b>Making the Electrical Connections</b> .....	11
Preparing Cable .....	11
To Remove Cover of Mains Terminal .....	11
Connecting to the Mains Terminal .....	12
Connecting to a Hob or Cooker Point .....	12
Checking Electrical Connections .....	12
<b>Fitting Into The Cabinet</b> .....	13
<b>Introduction</b> .....	14
Getting to Know Your Oven .....	14
Rating Plate .....	15
General Notes on Using The Ovens .....	15
When First Switching On .....	15
About Condensation and Steam .....	15
Cookware .....	15
The Cooling Fan for the Controls .....	15
Control Panel Indicator Neons .....	15
Grill and Oven Furniture .....	16
<b>The Electronic Minute Minder (Dorset only)</b> .....	17
<b>The Electronic Timer (Devon only)</b> .....	19
<b>The Grill</b> .....	23
Uses of the Dual Grill .....	23
Selecting the Dual Grill .....	23
Things to Note .....	23
The Grill Pan and Handle .....	23
Hints and Tips .....	24
Grilling Chart .....	25

# CONTENTS

<b>The Second Oven</b> .....	26
Uses of the Second Oven .....	26
Selecting the Second Oven .....	26
Things to Note .....	26
To Fit the Top Oven Shelf .....	26
Hints and Tips .....	26
<b>The Main Fan Oven</b> .....	28
Uses of the Fan Oven .....	28
Selecting the Fan Oven .....	28
Things to Note .....	28
To Fit the Main Oven Shelves .....	28
Hints and Tips .....	29
<b>Roasting Chart</b> .....	29
<b>Oven Cooking Chart</b> .....	30
<b>Defrosting</b> .....	31
Uses of Defrost Feature .....	31
Selecting Defrost .....	31
Things to Note .....	31
Hints and Tips .....	31
<b>Helpful Hints when Buying and Preparing Food</b> .....	32
<b>Care and Cleaning</b> .....	33
Cleaning Materials .....	33
Cleaning the Outside of the Cooker .....	33
Cleaning Inside the Ovens .....	33
Cleaning the Grill Deflector, Grill Pan, Grill Pan Grid and Oven Shelves .....	33
Cleaning Between the Outer and Inner Door Glass .....	33
Care of Stayclean Surfaces (Devon only) .....	34
Hints and Tips .....	34
Replacing the Oven Light Bulb .....	35
<b>Something Not Working?</b> .....	36
<b>Service and Spare Parts</b> .....	37
<b>Customer Service Centres</b> .....	38
<b>Guarantee Conditions</b> .....	42

## PREFACE

Dear Customer,

Thank you for buying a Tricity Bendix cooker. With our 80 years experience in developing and manufacturing the very best in U.K. cookers, you can be assured that you have purchased a hard working, reliable, quality cooker.

Tricity Bendix cookers comply with British Standard safety and performance requirements. They have been approved by BEAB (British Electrotechnical Approvals Board) and are covered by a 12 month parts and labour guarantee.

To get the best from your new Tricity Bendix cooker, we ask that you PLEASE READ THESE INSTRUCTIONS CAREFULLY. Particular attention should be made to cooking times and temperatures which may differ from your previous cooker.

It is most important that this instruction book is retained with the cooker for future reference. Should the cooker be sold, or transferred to another owner, or should you move house and leave the cooker, always ensure that the book remains with the cooker so that the new owner can be acquainted with the functioning of the cooker and the relevant warnings.

Please read the whole instruction book before attempting to use the cooker ensuring you follow the recommendations given.



## SAFETY

THESE WARNINGS ARE PROVIDED IN THE INTERESTS OF YOUR SAFETY. ENSURE THAT YOU UNDERSTAND THEM ALL BEFORE INSTALLING OR USING THE COOKER.

PLEASE  
READ  
CAREFULLY

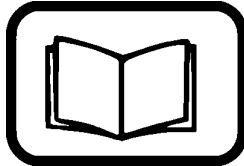

### BEFORE INSTALLATION



This cooker is heavy and care **must** be taken when moving it.



**Ensure** that all packaging, both inside and outside the cooker has been removed before the cooker is used.



**Do not** try to move the cooker by pulling the door handles. Refer to installation instructions.



The cooker must be installed according to the instructions supplied. Any electrical installation work **must** be undertaken by a qualified electrician/competent person.

**It is dangerous** to alter or modify the specifications of the cooker in any way.



After installation, please dispose of the packaging with due regard to safety and the environment.

### DURING OPERATION



**Do not** use this cooker if it is in contact with water and never operate it with wet hands.



This cooker is designed to be operated by adults. Young children **must not** be allowed to tamper with the cooker or play with the controls.

Accessible parts, especially around the grill area, may become hot when the cooker is in use. Children should be **kept away** until it has cooled.



Take **great care** when heating fats and oils as they will ignite if they become too hot.

This cooker has been designed for cooking edible foodstuffs only, and **must not** be used for any other purposes.



**Never** place plastic or any other material which may melt in the oven.



**Ensure** cooking utensils are large enough to contain foods to prevent spillages and boil overs.



Take care to follow the recommendations given for tending the food when grilling. Use the handle provided in the recommended way.



**Do not** leave the handle in position, when grilling, as it will become hot.



**Always** use oven gloves to remove and replace food in the oven. Similarly always use oven gloves to remove and replace the grill pan handle, when grilling. Recommendations given on page 23.

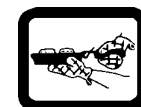

**Ensure** that you support the grill pan when it is in the withdrawn or partially withdrawn position.

**Ensure** that all vents are left unobstructed to ensure ventilation of the oven.



You must ensure that the grill control is in the 'OFF' position when the timer control has been set for automatic cooking. (Devon only).

**Ensure** that the anti-tilt shelves are put in place correctly. Refer to instructions on pages 26 and 28.



**Never** line any part of the cooker with aluminium foil. Do not allow heatproof cooking material, e.g. roasting bags, to come into contact with oven elements.



**Always** stand back from the cooker when opening the oven door to allow any build up of steam or heat to release.



Stand clear when opening the drop down oven door. **Do not** allow it to fall open - support it using the door handle, until it is fully open.



**Do not** place sealed cans or aerosols inside the oven. They may explode if they are heated.

## AFTER USE

**Ensure** that all control knobs are in the OFF position when not in use.



For hygiene and safety reasons this cooker should be kept clean at all times. A build-up of fats or other foodstuffs could result in a fire, especially in the grill pan.



**Do not** leave utensils containing foodstuffs, e.g. fat or oil in or on the cooker in case it is inadvertently switched ON.

Cookers and hobs become **very hot**, and retain their heat for a long period of time after use. Children should be kept well away from the cooker until it has cooled.

## GENERAL



**Under no circumstances** should repairs be carried out by inexperienced persons as this may cause injury or serious malfunction. This cooker should be serviced by an authorised Service Engineer and only genuine approved spare parts should be used. Details of servicing and repair arrangements are supplied on page 37 of this book.



**Do not** stand on the cooker or on the open oven door.



**Do not** hang towels, dishcloths or clothes from the cooker or its handle. They are a safety hazard.

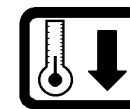

**Always** allow the cooling fan to cool the cooker down before switching off at the wall prior to carrying out any cleaning or maintenance work.



Only clean this cooker in accordance with the instructions given in this book.

**Your safety is of paramount importance.**

**Therefore, if you are unsure about any of the meanings of these WARNINGS contact the:**

**Consumer Care Department  
Telephone: (01582) 585858**

# INSTALLATION INSTRUCTIONS

## THINGS YOU NEED TO KNOW

### WARNINGS:

- This cooker must be installed by a qualified electrician/competent person. Safety may be impaired if installation is not carried out in accordance with these instructions.
- This cooker must be earthed.
- Do not remove the screws from the earth tab extending from the oven mains terminal block (Fig. 6).
- Before connecting the cooker make sure that the voltage of your electricity supply is the same as that indicated on the rating plate. The rating plate can be seen by opening the oven door and looking below the oven door seal.
- Do not alter the electrical circuitry of this cooker.

### THINGS TO NOTE

- This cooker is designed to be fitted in cabinets of the recommended dimensions as shown (Fig. 2).
- If your cabinet interior dimension is between 565-570mm the oven may still be fitted. However a minor modification to the cabinet will be required.
- The dimensions given provide adequate air circulation around the unit within the cabinet, ensuring compliance with BS EN60-335.
- Enquiries regarding the installation of the cooker point, if required, should be made to your Regional Electricity Company to ensure compliance with their regulations.
- The cooker socket switch should be outside the cabinet but within 2m of the cooker to make it accessible to switch off the cooker in case of an emergency.
- To protect the hands, wear gloves when lifting the oven into its housing.

### NOTE: HOUSE CIRCUIT

Earth leakage and continuity tests must be carried out before the cooker is connected to the mains supply and re-checked after fitting.

## GETTING THINGS READY

### CHOICE OF ELECTRICAL CONNECTION

- There are three possible ways to connect your cooker. In each case the cooker should be operated using at least 6mm<sup>2</sup> twin core and earth PVC insulated multicore cable. Please choose from the most appropriate after reading the different methods:-
- a) By connecting the cooker to a cooker point (having a double pole isolating switch with at least 3mm contact separation in all poles and neutral) and protected with a fuse or miniature circuit breaker at your mains fuse box.

**Subject to Regional Electricity Companies regulations if you wish to connect the oven and hob to the power supply you may use one of the following two methods:-**

- b) By connecting the cooker together with a hob directly to a cooker point(s). Having a double pole isolating switch with at least 3mm contact separation in all poles and neutral.
- c) If you wish to connect an oven and a hob to a cooker point you can by connecting the oven and hob separately to the cooker point. Oven and hob units should be separately connected to a control panel. See Fig. 1.

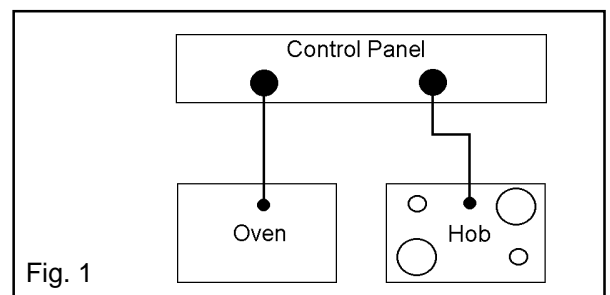

Fig. 1



**NOTE:** It is good practice to:

- Fit an Earth Leakage Circuit Breaker to your house wiring.
- Wire your appliance to the latest IEE regulations.

#### **PREPARING CABINET FOR FITTING OF OVEN**

- Make sure the cabinet is the correct size for the appliance to be fitted (Ref. Fig. 2).
- If the size is between 565-570mm, then the cabinet should be modified so that at the screw fixing points the recommended dimension of at least 560-565mm is maintained. The modification should ideally be localised to ensure that after screw fitment the oven is **securely** fixed into position.
- The cabinet must be stable and level by firmly securing it to the wall or floor. If necessary, make arrangements to ensure the shelf upon which the oven will rest is level.

# RECOMMENDED CABINET DIMENSIONS (IN MILLIMETRES)

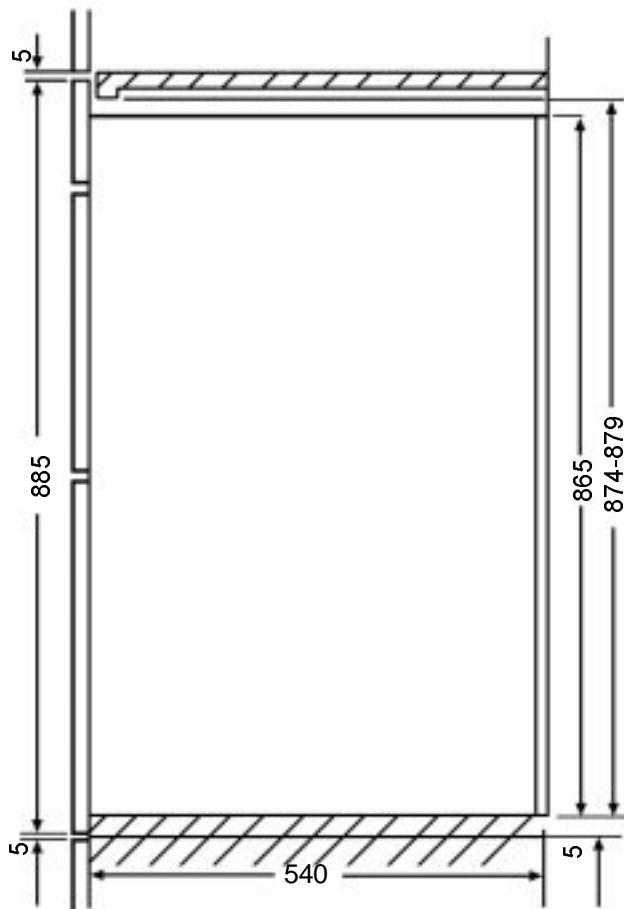
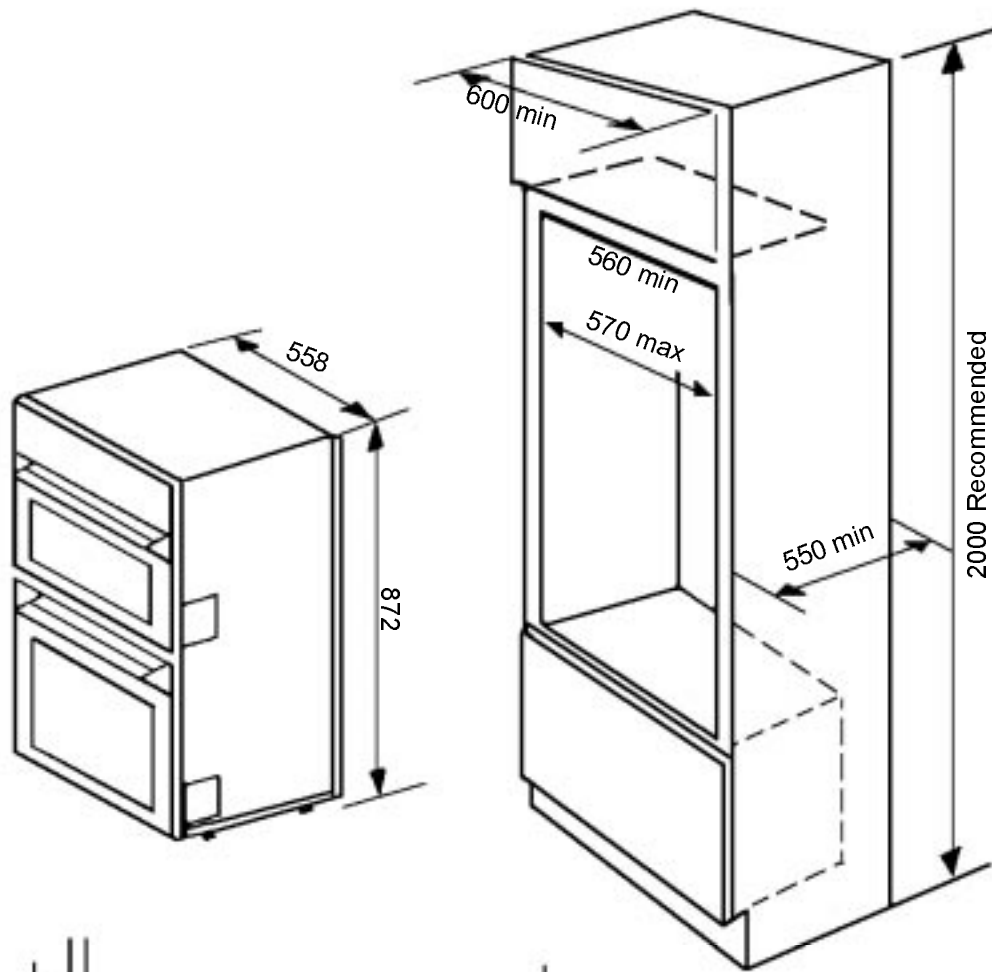

**Cross section  
through  
cabinet  
showing oven  
positioned**

Fig. 2 Built In Installation

## HOW TO FINISH UNPACKING

- Place packed cooker next to the cabinet in which it will be installed.
- Remove the cooker packing except for bottom tray which should be left in position until the cooker is ready to be fitted into its cabinet.
- Ensure the owner is given these operating instructions.

## TOOLS REQUIRED

The following tools will be needed and it helps to assemble them before starting to install your oven:

A terminal screwdriver (3mm wide blade)  
A pozidrive screwdriver  
Pliers  
Wirestrippers  
Knife  
Sidecutters  
Adhesive Tape  
Tape Measure

## MAKE THE ELECTRICAL CONNECTIONS

**Important: Switch off at mains, miniature circuit breaker and, if appropriate, remove fuse before commencing any electrical work.**

## PREPARING CABLE

We recommend you use a new length of cable to ensure your safety.

- Ensure you have the correct length of cable appropriate to the wiring method you are using. When fitting new cable allow sufficient cable for removal of the unit at a later date, should it be necessary.
- Score, but do not cut through, around the sheathing with a knife 100mm (4in) from each end of the cable and break through to the encased wires by bending the cable backwards and forwards to fatigue the sheathing.

- Carefully score down from each end of the cable sheathing along the length of the bare earth wire (if a cut was made along the length of the live or neutral wires, it might cut into their sheathing) to the cuts already made.
- Carefully prise open the sheathing at each end of the cable to expose the encased wiring.

## TO REMOVE COVER OF MAINS TERMINAL

From the rear of the cooker, remove mains input terminal cover to gain access to terminal block.

- First remove retaining screw with pozidrive screwdriver. See Fig. 3.

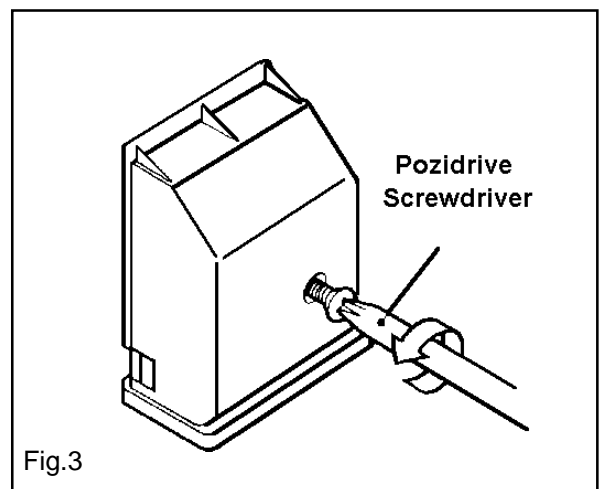

- Prise cover loose using screwdriver in position (1) then lever off with screwdriver in position (2) at either side. See Fig. 4.

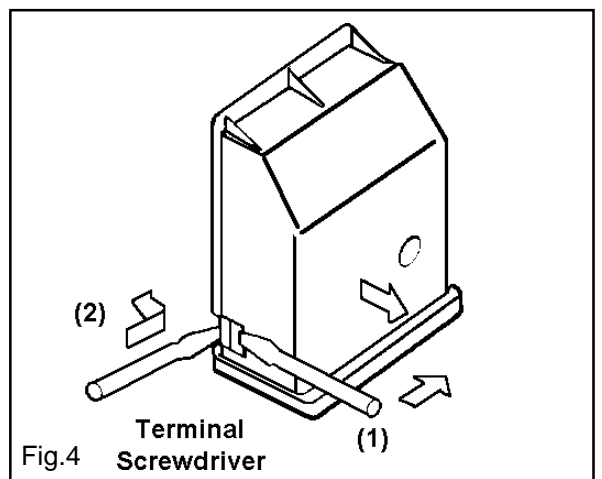

- Lift cover and remove screw from cable clamp. See Fig. 5.

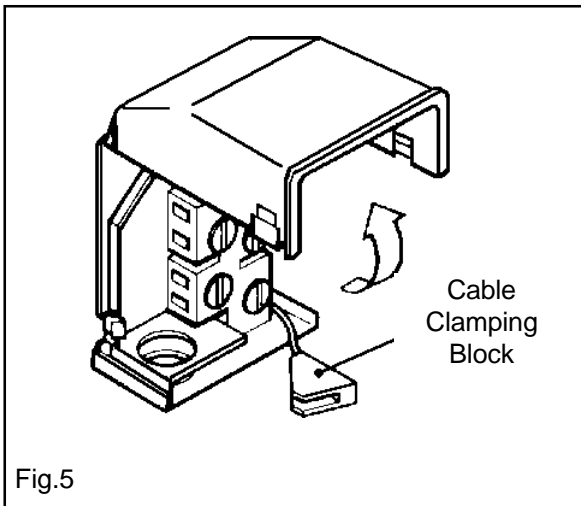

### CONNECTING TO MAINS TERMINAL

**Warning: This cooker must be earthed.**

- Make connection as shown in Fig. 6 by proceeding as follows:-

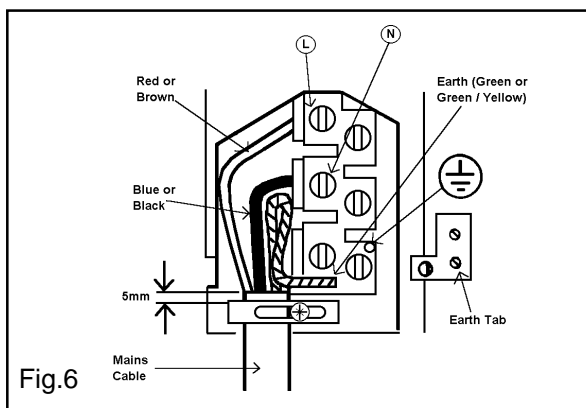

- Preform wires to the appropriate shape to suit fitting into the mains terminal block.
- Strip inner insulation on wires using wirestrippers.
- Twist the bared wires using pliers.
- Cut bared wires 10mm away from the end of the inner insulation. Where uninsulated Earth wires are used ensure they are suitably sheathed to leave 10mm bare wire to fit into the terminal.
- Clamp bare wires into the relevant terminal and check they are held by tugging each one in turn.

- Clamp the mains cable securely ensuring 5mm of the outer insulation is inside the terminal block and that the wires are not taught but not so slack as to cause any fouling. See Fig. 6.

- Place fuse/miniature circuit breaker in circuit and switch on at mains.

### CONNECTING TO A HOB OR COOKER POINT

**WARNING: THIS COOKER MUST BE EARTHED.**

- Either follow in general terms the instructions for connecting to the terminal block or refer to the hob suppliers installation instructions.

**Feed the cable through the cabinet and arrange to route the cable away from the cooker which may become hot.**

### CHECKING ELECTRICAL CONNECTIONS

- Correct electrical connection can be confirmed when switching on the appliance as the electronic timer will be flashing.

### NOTE: HOUSE CIRCUIT

Earth leakage and continuity tests must be carried out before the cooker is connected to the mains supply and re-checked after fitting.

## FITTING INTO THE CABINET

**IMPORTANT:** Ensure that the oven is switched off at the wall before any further work is carried out.

- Using a tape measure establish the internal width of the cabinet. Refer to page 8 if greater than 565mm.
  - Position the cooker in front of the cabinet. See Fig. 7.
  - Take out all oven furniture before installation to reduce the weight you need to lift. The oven door should be taped up to keep it closed whilst lifting.
  - To place the cooker into the cabinetry follow the procedure below:
  - N.B. Two people will be required to carry out the lifting procedure.
- a) Each person should squat either side of the cooker.
  - b) Tilt the cooker so that your hands can support the underside of the cooker.
  - c) Keeping your back straight, raise the appliance to the cabinet by straightening at the knees.
  - d) Rest the rear underside of the cooker on the cabinet floor while your hands support the front.
  - e) The cooker can be pushed fully into the cabinet. Take care to avoid fouling the mains lead.
  - f) Ensure the cooker is central in the cabinet and level.
  - g) When the cooker is fully housed screw the stability screws, (supplied with the cooker) into the side of the cabinet taking care not to distort the side trims (See Fig. 8). It is advisable to turn each screw alternately to avoid damaging the trims.
  - h) Switch on the cooker then refer to the operating instructions in the following pages.

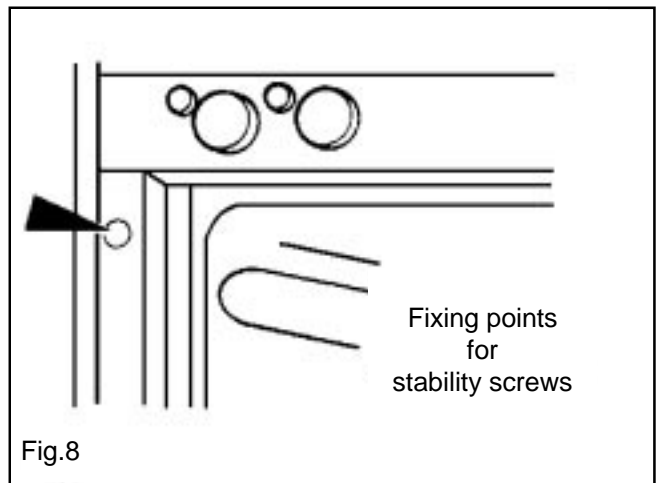
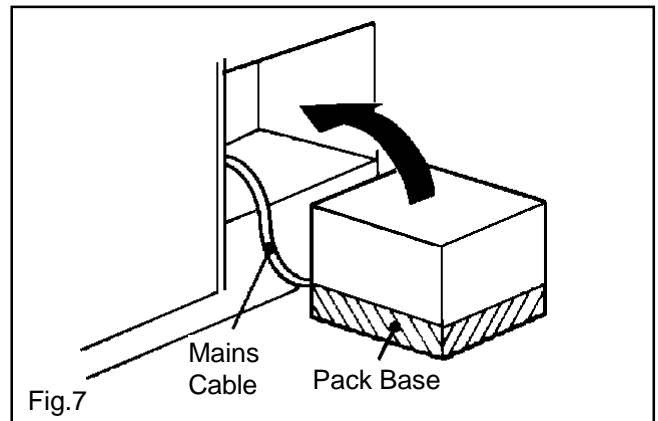

## INTRODUCTION

**WARNING: THIS COOKER MUST BE EARTHED**

### GETTING TO KNOW YOUR OVEN (DORSET).

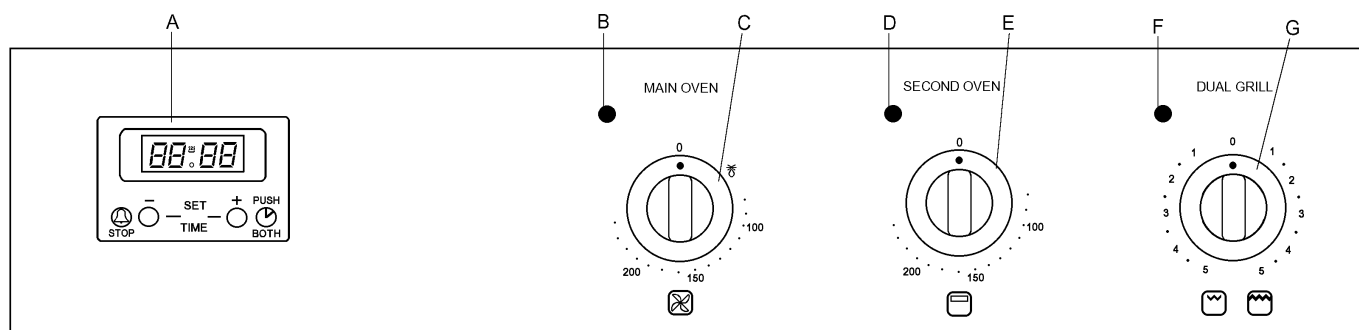

A - Electronic Minute Minder

B - Main Oven Indicator Neon

C - Main Oven Temperature Control

D - Second Oven Indicator Neon

E - Second Oven Temperature Control

F - Dual Grill Indicator Neon

G - Dual Grill Control

### GETTING TO KNOW YOUR OVEN (DEVON).

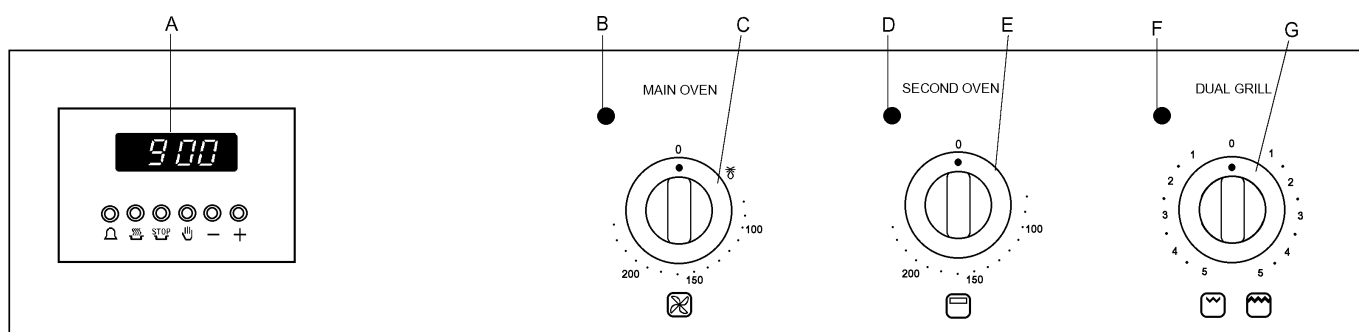

A - Electronic Timer

B - Main Oven Indicator Neon

C - Main Oven Temperature Control

D - Second Oven Indicator Neon

E - Second Oven Temperature Control

F - Dual Grill Indicator Neon

G - Dual Grill Control

## RATING PLATE

Record the model and serial numbers of your cooker on the back cover of this instruction book. These numbers can be found on the lower front frame of the cooker upon opening the oven door.

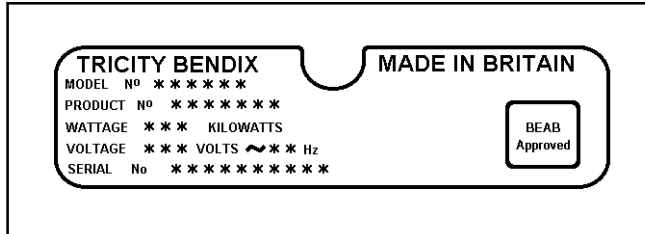

The cooker must be protected by a suitably rated fuse or circuit breaker. The rating of the cooker is given on the rating plate.

## GENERAL NOTES ON USING THE OVENS

We suggest that you run all the elements for a short period to burn off any residue from their surfaces.

During this period an unpleasant odour may be emitted, it is therefore advisable to open a window for ventilation.

### WHEN FIRST SWITCHING ON ( Dorset only )

When first switched on, the timer will make an audible sound. To stop the sound press both timer buttons together.

This must be done whenever the cooker has been switched off at the wall or when there has been a power failure. See page 17 for further information about setting the time of day and use of the minute minder.

### ( Devon only )

The timer must be set for manual cooking before the oven will operate. See page 19 for details on how to set the timer.

## ABOUT CONDENSATION AND STEAM

When food is heated it produces steam similar to a boiling kettle. The ovens are vented to allow some of this steam to escape. However, always stand back from the cooker when opening the oven door to allow any build up of steam or heat to release.

If the steam comes into contact with a cool surface on the outside of the cooker, e.g. a trim, it will condense and produce water droplets. This is quite normal and is not caused by a fault on the cooker.

To prevent discolouration, regularly wipe away condensation and also soilage from surfaces.

## COOKWARE

Baking trays, oven dishes etc., should not be placed directly against the grid covering the fan at the back of the oven.

Do not use baking trays larger than 30cm x 35cm (12" x 14") as they will restrict the circulation of heat and may affect performance.

## THE COOLING FAN FOR THE CONTROLS

The cooling fan comes on immediately when the grill is switched on and after a short time when the ovens are in use. It may run on after the controls are switched off until the cooker has cooled. During the initial period the cooling fan may cycle ON and OFF, this is quite normal.

Do not switch off the cooker at its power point before the cooling fan has cooled the appliance down.

## CONTROL PANEL INDICATOR NEONS

These lights indicate whether the ovens or grill are switched ON. In the case of the oven, the neon also indicates when the set temperature has been reached.

If the neons do not operate as the instructions indicate the controls have been incorrectly set. Return all controls to zero and reset following the instructions for the required setting.

(Devon only)

When the oven is set for automatic cooking the neon remains unlit during OFF periods.

## GRILL AND OVEN FURNITURE

The following items of grill and oven furniture have been supplied with the cooker.

1 grill pan/meat tin



1 grill pan handle

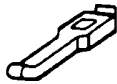

1 grill pan grid

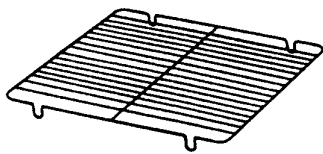

1 grill deflector



1 cranked shelf  
(for grilling  
and second  
oven cooking only)

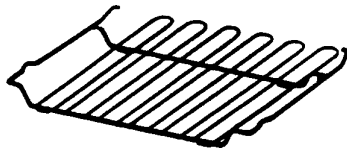

2 straight shelves  
(for main oven  
cooking)

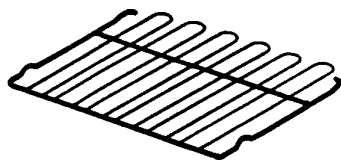

( Devon only )

Scuffing of the Stayclean oven lining by the oven furniture pack may occur during transit.

These marks will disappear after the oven elements have been burnt off for the first time.



# THE ELECTRONIC MINUTE MINDER (DORSET ONLY)

- 1 = (-) DECREASE CONTROL & MINUTE MINDER SETTING BUTTON
- 2 = (+) INCREASE CONTROL
- (☹) COOKING SYMBOL
- (🕒) PUSH BOTH CLOCK SETTING CONTROL
- (🔔) MINUTE MINDER SYMBOL

The electronic minute minder can also indicate the time of day.

## 1. TO SET THE TIME OF DAY

When the electricity supply is first switched ON, the display will flash both 88.88 and (☹). See Fig. 1.

Press buttons (1) and (2) together. The display will read 12:00. See Fig. 2.

Within five seconds press and hold either button (1) to decrease or button (2) to increase the time until the correct time of day on the 24 hour clock is reached, e.g. 14:30. The cooking symbol (☹) will go out. See Fig. 3.

**Note: The increase and decrease control buttons operate slowly at first, and then more rapidly. They should be pressed separately.**

## 2. THE MINUTE MINDER

The minute minder can be used to time a set cooking period.

The minute minder gives an audible reminder at the end of any period of cooking up to 23 hours and 59 minutes.

To set press button (1) and the display will read 00:00, see Fig. 4.

Release button (1) and press and hold button (2). The display will count up in one minute intervals until the interval to be timed is reached e.g. 30 minutes, see Fig. 5. If necessary press and hold button (1) to achieve the correct time interval.

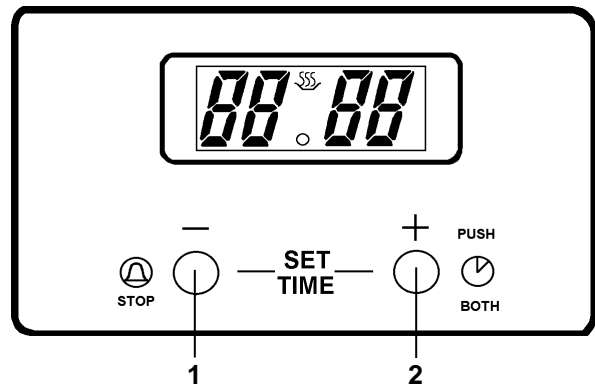

Fig. 1

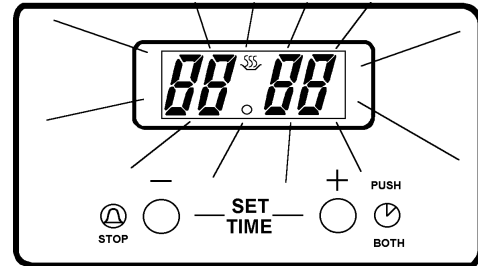

Fig. 2

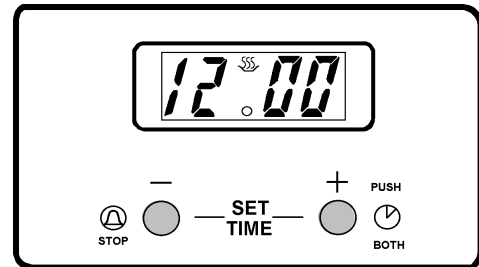

Fig. 3

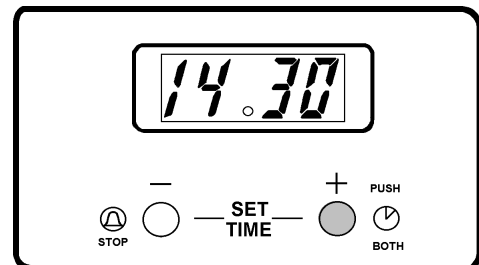

Fig. 4

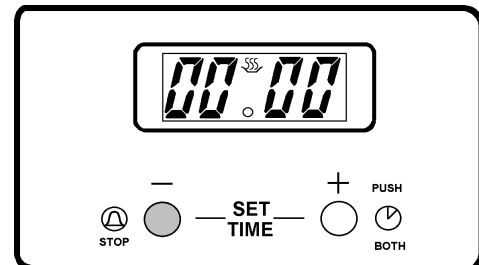
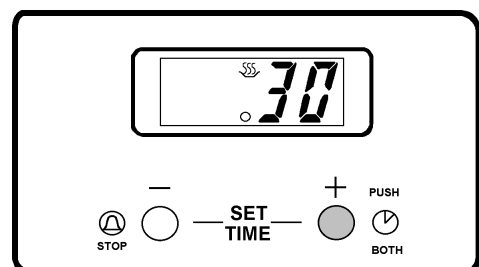

Fig. 5



The minute minder will begin to count down once set. At the end of the timed period, an audible signal will sound for up to 30 seconds. The display will flash showing the time of day. See Fig. 6.

To stop the sound and flashing press button (1). The display will stop flashing and show the time of day, e.g. 15:00. The cooking symbol (☹) will go out, see Fig. 7.

When cooking is complete remove food and turn OFF correct oven temperature control.

### 3. TO CANCEL THE MINUTE MINDER

Press and hold button (1) and the display will count down in one minute intervals to 00:00. See Fig. 8. Release button (1).

To reset the time of day, press buttons (1) and (2) together. See Fig. 9.

### 4. THINGS TO NOTE

1. If at first you do not set the time of day correctly, reset the clock by pressing and holding button (1). The display will count back to 00:00. Release the button. After a few seconds the display will reset to show 12:00. To reset the time of day follow the procedure laid down in point 1 on page 17.

Fig. 6

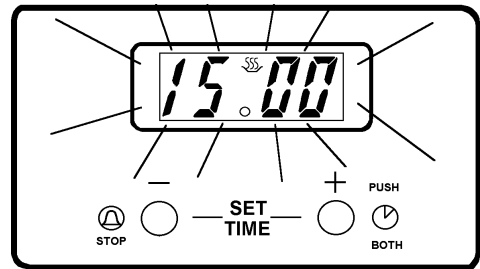

Fig. 7

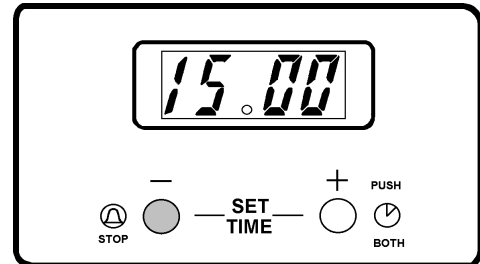

Fig. 8

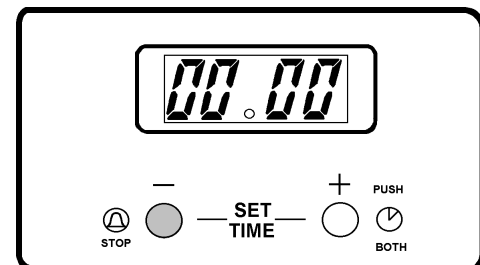
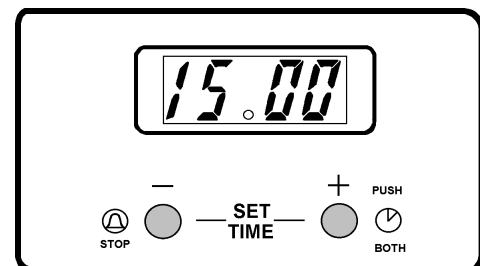

Fig. 9



# THE ELECTRONIC TIMER (DEVON ONLY)

## KEY

- A AUTO DISPLAY
- B MINUTE MINDER BUTTON
- C COOKING HOURS BUTTON
- D STOP TIME BUTTON
- E COOKING SYMBOL
- F MANUAL SELECTOR BUTTON
- G DECREASE CONTROL
- H INCREASE CONTROL

## NOTE:

**STEP 1 BELOW MUST BE FOLLOWED BEFORE THE OVEN WILL OPERATE MANUALLY.**

### 1. SET THE TIME OF DAY

When the electricity supply is first switched ON, the display will flash both 0.00 and AUTO. See Fig. 1.

Press the two buttons marked (👉) and (STOP) press the increase control button (+) and, if necessary, the decrease control button (-) until the correct time on the 24 hour clock is reached, e.g. 10.00am as Fig. 2.

**Note: The increase and decrease control buttons operate slowly at first, and then more rapidly. They should be pressed separately.**

The AUTO symbol will go out when the correct time of day is set. See Fig. 2.

### 2. THE MINUTE MINDER

The minute minder gives an audible reminder at the end of any period of cooking up to 23 hrs 59 mins. It is not part of the automatic control.

To set, press the minute minder button (🔔) and the digital display will read 0.00 and the bell symbol will glow, as Fig. 3.

Press the increase control (+) until the display indicates the interval to be timed, e.g. 1hr 45 mins as Fig. 4.

**NOTE: This must be completed within 4 seconds of first pressing the minute minder button.**

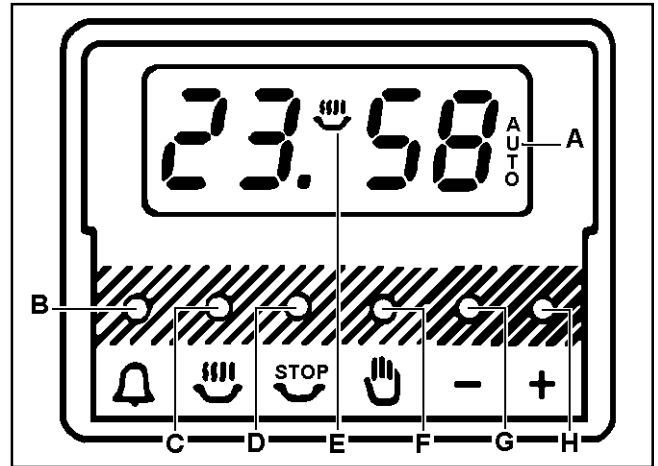

Fig. 1

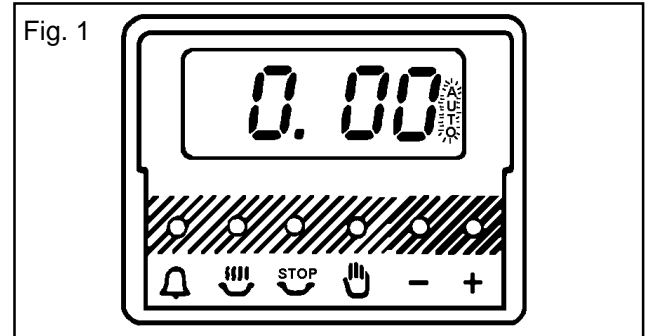

Fig. 2

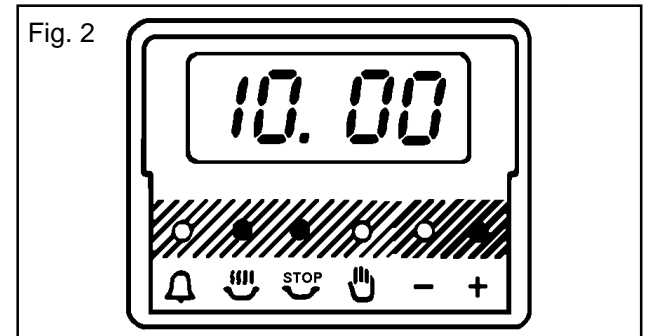

Fig. 3

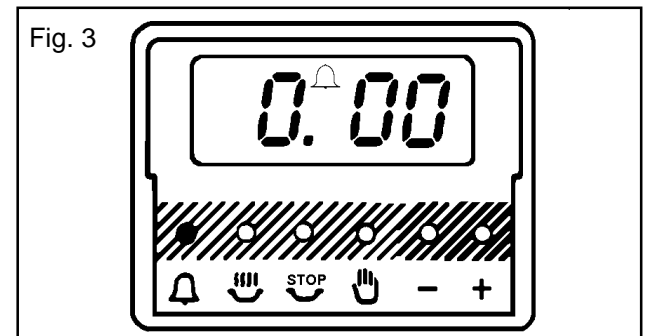
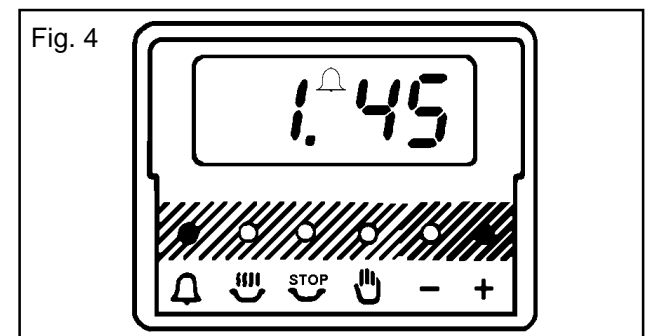

Fig. 4



Release the minute minder button and the display will return to the time of day after 5 seconds.

During the operation of the minute minder the remaining time period can be shown in the display by pressing the minute minder button (🔔). See Fig. 5.

The minute minder will sound intermittently, for up to 2 minutes and the bell symbol will flash at the end of the timed period. The sound can be stopped by pressing any of the 4 left hand side buttons.

### 3. HOW TO SET THE OVEN TIMER CONTROL

When using the timer control for the very first time, it is advisable to let it operate while you are at home. The displays can be checked to show that it is operating correctly and you will then feel confident to leave a meal to cook automatically in the future.

#### A) TO SET THE TIMER TO SWITCH ON AND OFF AUTOMATICALLY

- i) Ensure the electricity supply is switched ON and that the correct time of day is displayed, e.g. 9 a.m. as Fig. 6.
- ii) Place food in oven.
- iii) To set the length of Cooking Time, press the cooking hours button (🔥), press the increase control (+) until the cooking time is displayed, e.g. 2 hrs 15 mins. Fig 7.
- iv) Release the buttons. The AUTO display and cooking symbols will glow.

**Remember, this must be completed within 4 seconds of first pressing the cooking hours button.**

- v) Set the STOP time. Press the stop time button (STOP), press the increase control (+) until the required stop time is displayed, e.g. 12.15p.m. Fig. 8.
- vi) Release the buttons. The cooking symbol will go out and the time of day will be displayed after 5 seconds.
- vii) Set the oven control to the required temperature. The oven indicator neon should be OFF and the AUTO display will glow.

Fig. 5

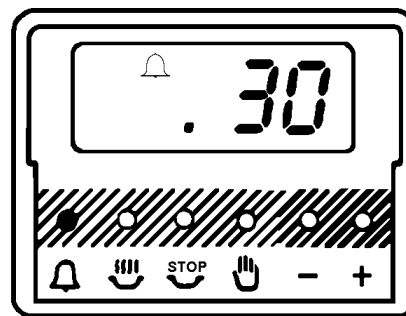

Fig. 6

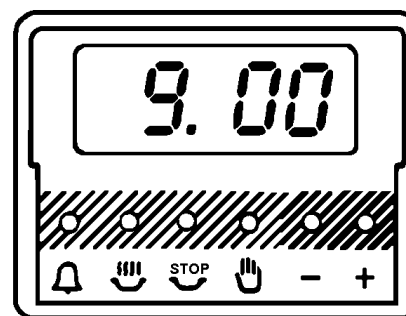

Fig. 7

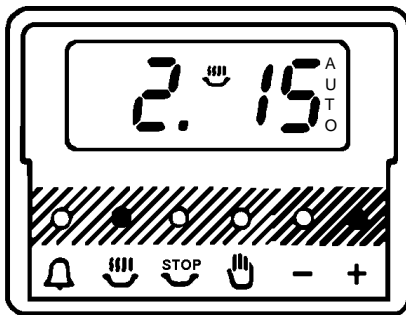
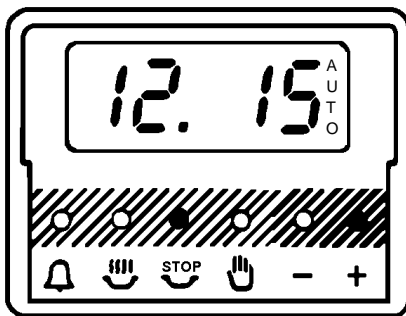



Fig. 8



**Note:** When the automatic timed period starts, the oven neon will cycle ON and OFF during cooking.

#### B) TO SET THE TIMER TO SWITCH OFF ONLY

- i) Ensure the electricity supply is switched ON and that the correct time of day is displayed, e.g. 10.00am. Fig. 9.
- ii) Place food in oven.
- iii) To set the Length of Cooking Time press the cooking hours button (  ) press the increase control ( + ) until the cooking time is displayed, e.g. 2 hrs 15 mins. Fig. 10.
- iv) Release the buttons. The AUTO display will glow and the time of day will be displayed after 5 seconds.
- v) Set the oven temperature. The oven indicator neon should come on.
- vi) To check the stop time during the cooking period, simply press the stop time button (  ) and the stop time will be displayed. Fig. 11.

#### 4. RETURNING THE COOKER TO MANUAL OR TO CANCEL AN AUTOMATIC PROGRAMME.

At the end of a timed cooking period, the AUTO light will flash and a bleeper will sound for up to 2 mins. This can be stopped by pressing any of the 4 left hand side buttons. Fig. 12.

Turn the oven temperature control to the OFF position. The AUTO display will continue to flash.

Press (  ) button. The AUTO display will go out. Fig. 13.

Turn the oven control ON to check that the oven operates manually. The oven indicator neon will glow.

Turn the oven control OFF. No indicator neons should be illuminated.

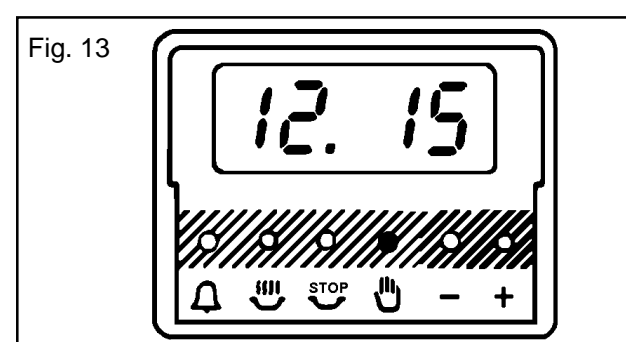
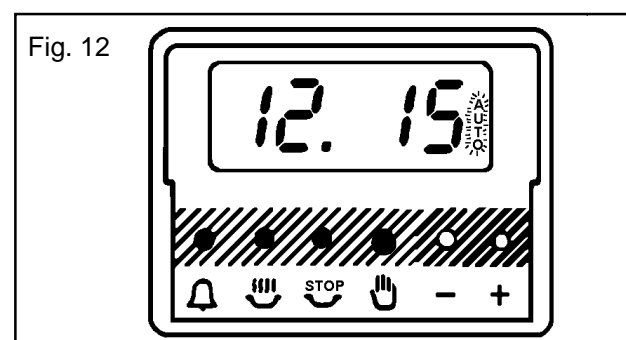
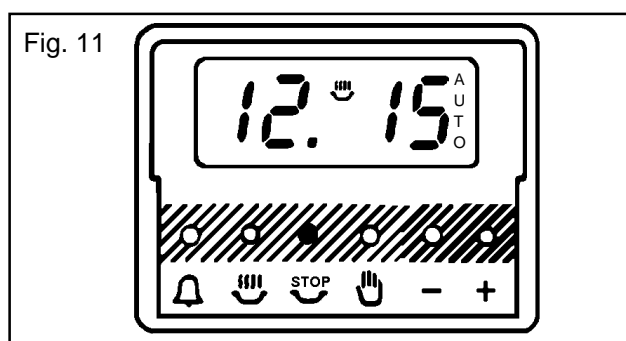
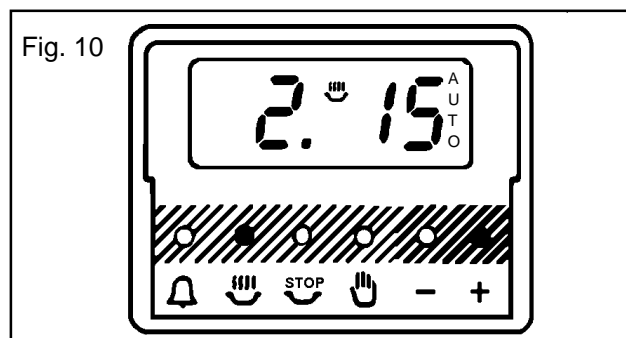
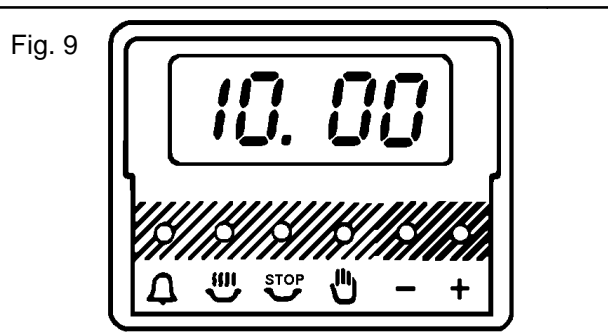

## 5. THINGS TO NOTE

- \* The time of day cannot be altered whilst the AUTO symbol is lit.
- \* A programme may be cancelled by returning the cooking hours to zero. Press the cooking hours button (🔥) depress ( - ) button until 0.00 is displayed. Fig. 14.
- \* Release all buttons. The AUTO display will now flash and acts as a reminder to reset the appliance to manual.

## 6. AUTOMATIC COOKING

It is advisable to leave food in the oven for as short a time as possible before automatic cooking.

When cooking is complete do not leave food to stand in the oven, but remove and cool it quickly if the food is not to be consumed immediately.

Always ensure food in the oven is covered if its not possible to remove food immediately after cooking.

Fig. 14

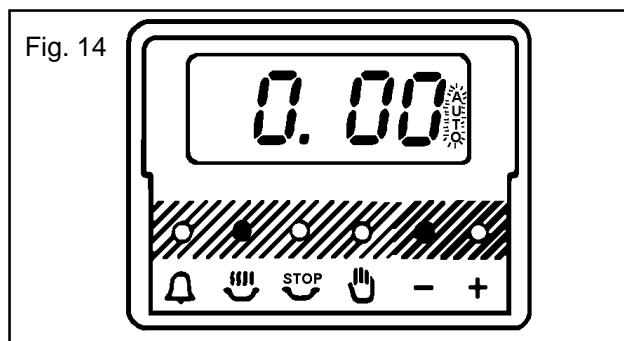

## THE GRILL

### USES OF THE DUAL GRILL

**CAUTION - ACCESSIBLE PARTS MAY BECOME HOT WHEN THE GRILL IS IN USE. CHILDREN SHOULD BE KEPT AWAY.**

The grill is a dual circuit grill which means that the whole area of the grill can be used or, for economy purposes the centre section only can be used when cooking smaller quantities of food.

### SELECTING THE DUAL GRILL (DORSET/ DEVON).

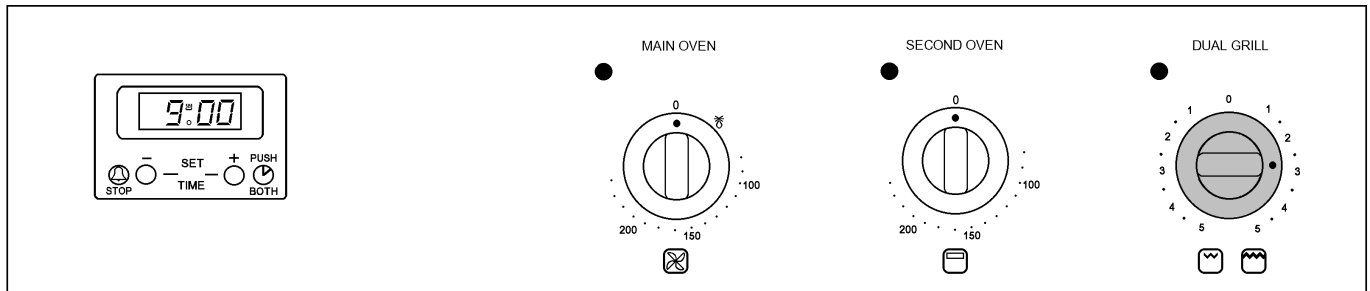

- Turn the grill control clockwise for full grill or anticlockwise for the centre section only.
- Ensure the second oven control is in the OFF position '0'.

### THINGS TO NOTE

#### THE GRILL DOOR MUST BE LEFT OPEN DURING GRILLING

1. The cooling fan for the controls will operate in conjunction with the grill.
2. The grill indicator neon will illuminate.
3. The outer grill element may appear to glow slightly brighter than the inner element. This is quite normal.
4. The dual grill operates independently of the oven.

### THE GRILL PAN AND HANDLE

The grill pan is supplied with a removable handle.

To insert the handle, press the button on the handle with the thumb and pivot the handle slightly upwards inserting the lip into the widest part of the bracket. Move the handle towards the left, lower into position and release the button.

#### Ensure the handle is positively located.

When removing the handle press the button on the handle with the thumb and pivot the handle slightly upwards and towards the right to remove from the bracket.

**Ensure your hand is protected when removing the grill pan handle as the grill element can become very hot.**

ALWAYS REMOVE THE GRILL PAN HANDLE DURING GRILLING

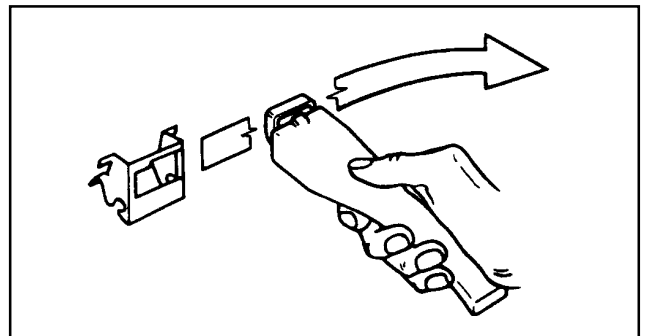

To correctly locate the grill pan on the shelf, ensure that the cut-out on the underside of the handle bracket locates over the front bar of the shelf.

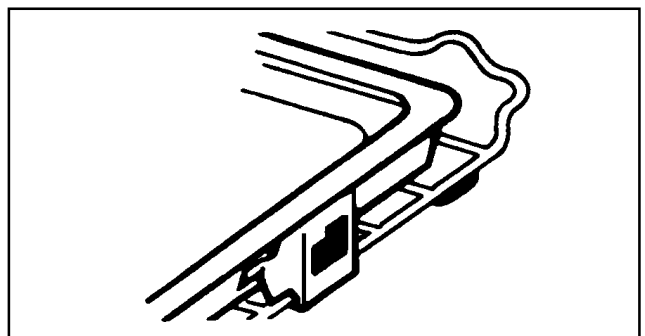

To check the progress of the food being grilled, the grill pan should be withdrawn on the shelf to attend to food during cooking.

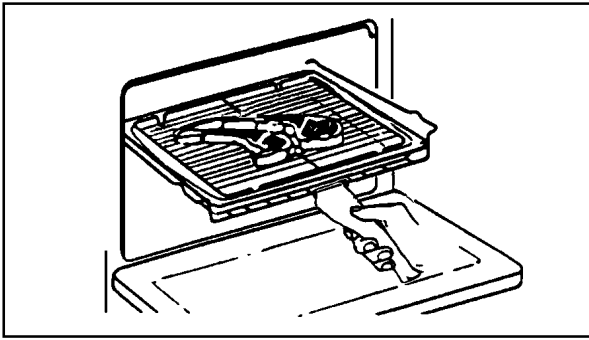

## HINTS AND TIPS

- Most foods should be placed on the grid in the grill pan to allow maximum circulation of air to lift the food out of the fats and juices. Food such as fish, liver and kidneys may be placed directly on the grill pan base if preferred.

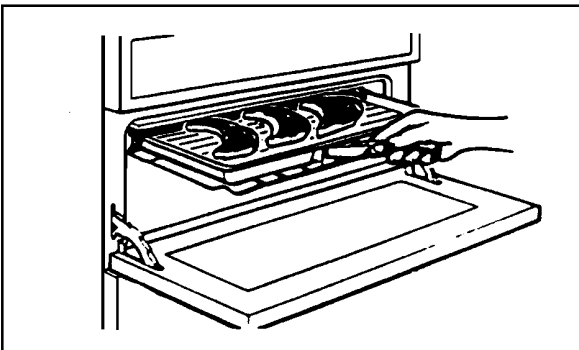

- Adjust the grid and grill pan runner position to allow for different thicknesses of food. Position the food close to the element for faster cooking and further away for more gentle cooking.

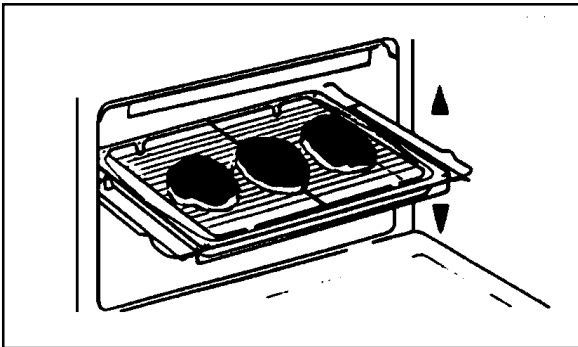

- Food should be thoroughly dried before grilling to minimise splashing. Brush lean meats and fish lightly with a little oil or melted butter to keep them moist during cooking.

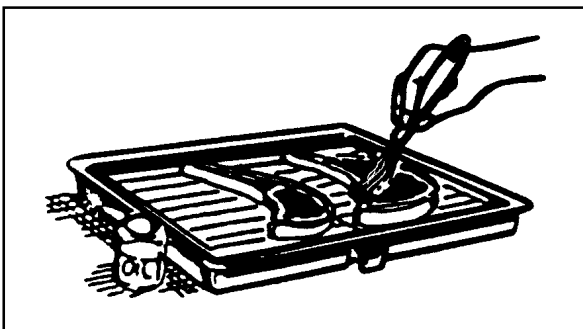

- Accompaniments such as tomatoes and mushrooms may be placed underneath the grid when grilling meats.

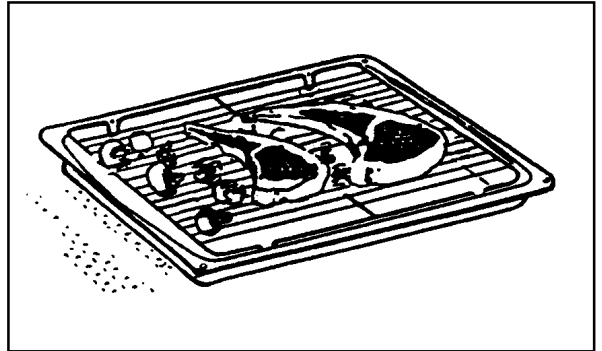

- When toasting bread, we suggest that the top runner position is used with the grid in its 'high' position.
- Preheat the grill on a full setting for a few minutes before sealing steaks or toasting. Adjust the heat setting and the shelf as necessary during cooking.
- The food should be turned over during cooking as required.

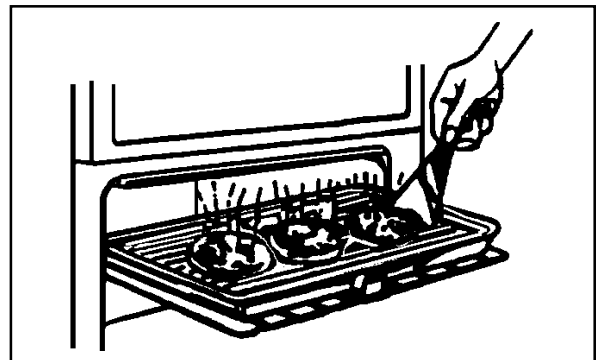



## GRILLING CHART

FOOD	SHELF	GRILL TIME (mins in total)
Toast	2crk.	4-6
Bacon Rashers	2crk.	10
Beefburgers	2crk.	10-15
Chicken Joints	2crk.	30-40
Chops - Lamb	2crk.	15-20
Pork	2crk.	20-30
Fish - Whole Trout/Mackerel	2crk.	15-25
Fillets - Plaice/Cod	2crk.	15
Kebabs	2crk.	20-30
Kidneys - Lamb/Pig	2crk.	8-12
Sausages	2crk.	20-30
Steaks - Rare	2crk.	6-12
Medium	2crk.	12-16
Well Done	2crk.	14-20
Toasted Sandwiches	2crk.	3-4

crk. = Cranked Shelf

Shelf positions are counted from the bottom of the oven upwards.

The times quoted above are given as a guide and should be adjusted to suit personal taste.

The cranked shelf should be used for grilling and top oven cooking only.

## THE SECOND OVEN

### USES OF THE SECOND OVEN

The second oven is the smaller of the two ovens. It is heated by elements in the top and bottom of the oven. It is designed for cooking smaller quantities of food. It gives especially good results if used to cook fruit cakes, sweet and savoury flans or quiche.

The second oven is also ideal for use as a warming compartment to warm dishes and keep food hot. Use a temperature setting of 80° - 100°C on the second oven temperature control.

### SELECTING THE SECOND OVEN (DORSET/ DEVON).

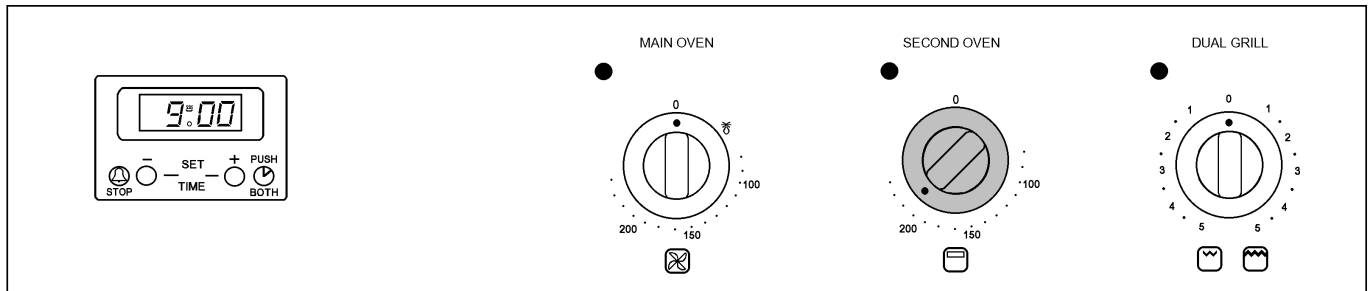

- Ensure the grill control is in the off, '0' position.
- Turn the second oven temperature control to the required setting.

### THINGS TO NOTE

1. The second oven indicator neon will glow until the oven has reached the desired temperature and then go out. It will cycle ON and OFF periodically during cooking showing that the temperature is being maintained.
2. The cooling fan for the controls will operate, after a period of time.
3. Dishes, tins or trays should not be placed directly on the oven floor as it becomes very hot and damage will occur.

### TO FIT THE TOP OVEN SHELF

The cranked shelf should be fitted with the straight rods uppermost on the frame and the forms towards the back of the oven. If not fitted correctly the anti-tilt and safety stop mechanism will be affected.

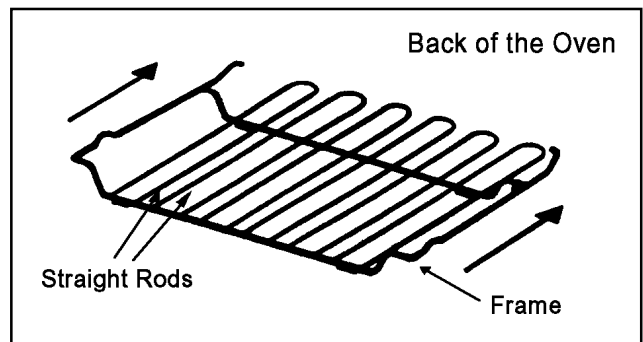

### HINTS AND TIPS

- All cooking should be carried out on shelf positions one and two using a cranked shelf. When more space is required, for example when roasting or casseroles, a straight shelf from the main oven may be placed on the second oven base.

- There should always be at least 2.5cm (1") between the top of the food and the element. This gives best cooking results and allows room for rise in yeast mixtures, Yorkshire puddings etc. When cooking cakes, pastry, scones, bread etc., place the tins or baking trays centrally below the element.

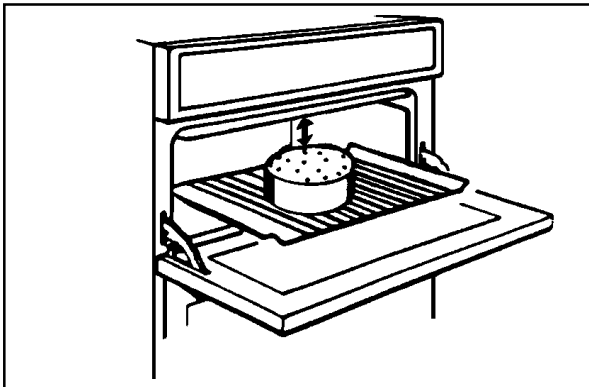

- Ensure that food is placed centrally on the shelf and there is sufficient room around the baking tray/dish to allow for maximum circulation.

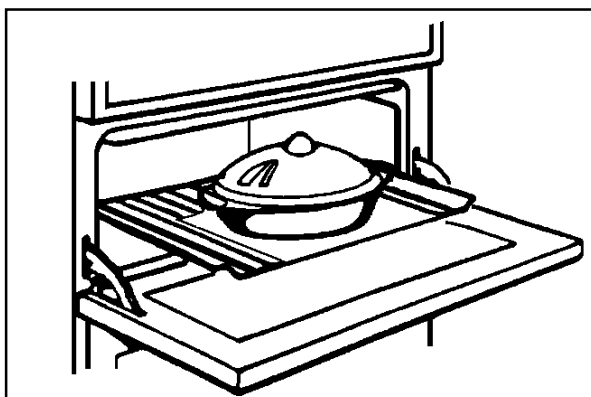

- Stand dishes on suitably sized baking trays to prevent spillage onto the oven base and to help reduce cleaning.
- The use of excessively high temperatures can cause uneven browning. It may be necessary to reduce temperatures slightly. Refer to the recommendations given in the oven cooking chart, see page 30.
- The material and finish of the baking tray and dishes will affect the degree of base browning of the food. Enamelware, dark, heavy or non-stick utensils increase base browning. Shiny aluminium or polished steel trays reflect the heat away and give less base browning.
- DO NOT use the grill pan as a baking tray as this will increase base browning of the food.

- Because of the smaller cooking space, lower temperatures and shorter cooking times are sometimes required. Be guided by the recommendations on page 30.

- For economy leave the door open for the shortest possible time, particularly when placing food into a pre-heated oven.

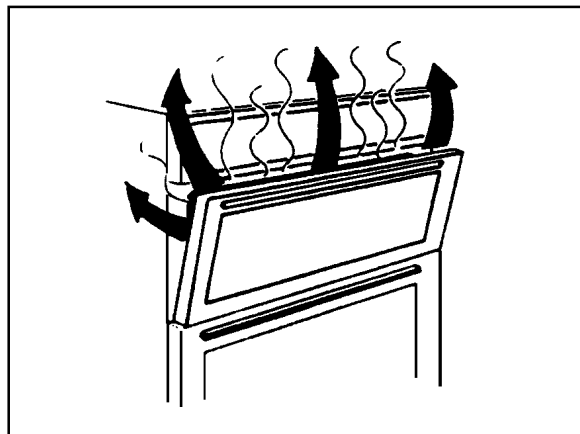

# THE MAIN FAN OVEN

## USES OF THE FAN OVEN

### PREHEATING

The fan oven quickly reaches its temperature, so it is not usually necessary to preheat the oven. Without preheating however, you may find you need to add an extra 5-10 minutes on the recommended cooking times. For recipes needing high temperatures, e.g. bread, pastries, scones, soufflés, etc., best results are achieved if the oven is preheated first.

### COOKING TEMPERATURES

Fan oven cooking generally requires lower temperatures than conventional cooking. Follow the temperatures recommended in the chart on page 30. As a guide reduce temperatures by about 20°C-25°C for your own recipes.

### BATCH BAKING

The fan oven cooks evenly on all shelf levels, especially useful when batch baking.

### SELECTING THE FAN OVEN (DORSET/ DEVON).

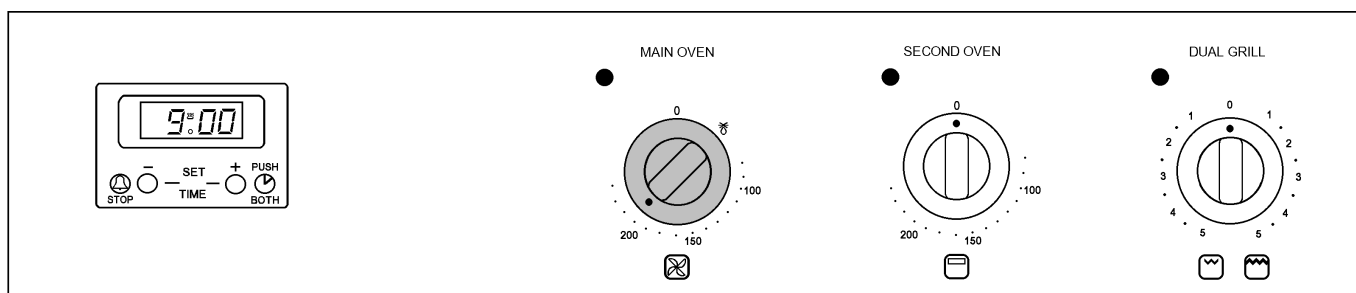

- Turn the main oven temperature control to the required setting.

### THINGS TO NOTE

- 1) The main oven indicator neon will glow until the oven has reached the desired temperature and then go out. It will cycle ON and Off periodically during cooking showing that the temperature is being maintained.
- 2) The oven fan will operate continually during cooking.
- 3) The cooling fan for the controls operates after a period of time.
- 4) The internal oven light will come on.

### TO FIT THE MAIN OVEN SHELVES

The shelves should be fitted with the straight rods uppermost on the frame and the forms towards the back of the oven. If not fitted correctly the anti-tilt and safety stop mechanism will be affected. Only use straight shelves in the main oven.

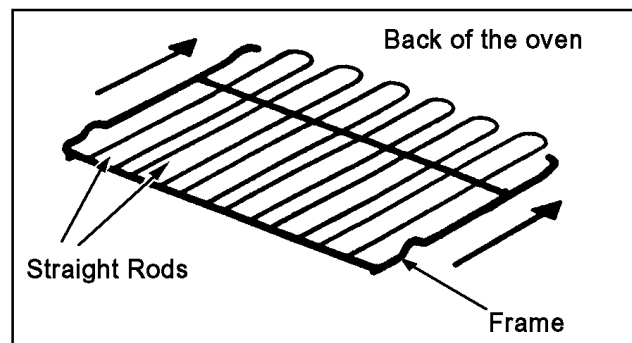

## HINTS AND TIPS

- Arrange the shelves in the required positions before switching the oven ON. Shelves are numbered from the bottom upwards.

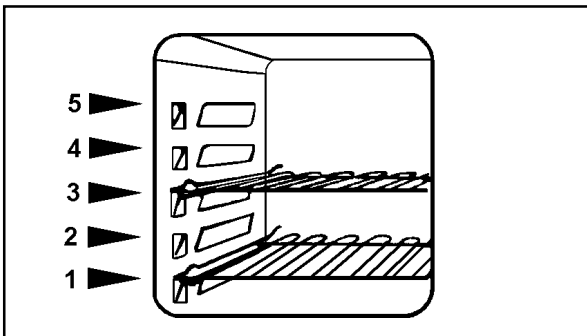

- When cooking more than one dish in the fan oven, place dishes centrally on different shelves rather than cluster several dishes on one shelf, this will allow the heat to circulate freely for the best cooking results.
- When batch baking one type of food, e.g. Victoria sandwich cakes, those of similar size will be cooked in the same time.

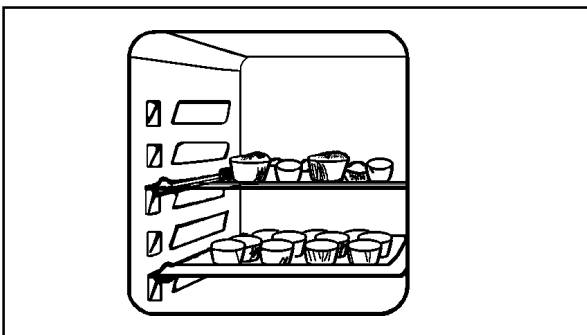

- Do not use the cranked shelf from the grill in the main oven.
- It is recommended that when baking larger quantities, the shelf positions should be evenly spaced to suit the load being cooked. A slight increase in cooking time may be necessary.
- DO NOT place baking trays directly on the oven floor as it interferes with the oven air circulation and can lead to base burning; use the lower shelf position. However, non critical dishes may be placed on the oven base when more space is required.

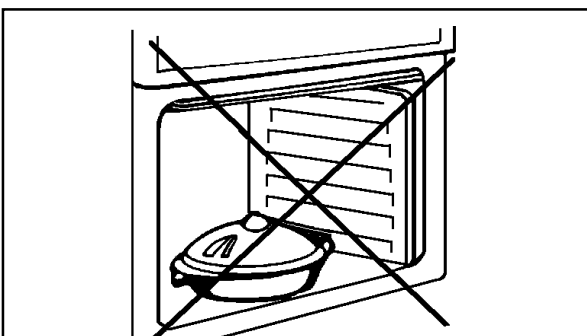

## ROASTING CHART

### INTERNAL TEMPERATURES -

Rare : 50-60°C; Medium : 60-70°C; Well : 70-80°C

MEAT	SECOND/FAN OVEN	COOKING TIME
Beef	160-180°C	20-35 min per ½kg/1lb and 20-35 min over
Beef, boned	160-180°C	20-35 min per ½kg/1lb and 25-35 min over
Mutton and Lamb	160-180°C	25-35 min per ½kg/1lb and 25-35 min over
Pork and Veal	160-180°C	30-40 min per ½kg/1lb and 30-40 min over
Ham	160-180°C	30-40 min per ½kg/1lb and 30-40 min over
Chicken	160-180°C	15-20 min per ½kg/1lb and 20 min over
Turkey and Goose	160-180°C	15-20 min per ½kg/1lb up to 3½kg/7lb then 10 min per ½kg/1lb
Duck	160-180°C	25-35 min per ½kg/1lb and 25-30 min over
Pheasant	160-180°C	35-40 min per ½kg/1lb and 35-40 min over
Rabbit	160-180°C	20 min per ½kg/1lb and 20 min over
Potatoes with meat	160-180°C	according to size
Potatoes without meat	180-190°C	according to size

The roasting temperatures and times given in the chart should be adequate for most joints, but slight adjustments may be required to allow for personal requirements and the shape and texture of the meat. However, lower temperatures and longer cooking times are recommended for less tender cuts or larger joints.

Wrap joints in foil if preferred, for extra browning uncover for the last 30-60 min cooking time.

## OVEN COOKING CHART

The oven temperatures are intended as a guide only. It may be necessary to increase or decrease the temperatures by 10°C to suit individual preferences and requirements.

FOOD	FAN OVEN		TOP OVEN		
	SHELF POSITION	COOKING TEMP °C	SHELF POSITION	COOKING TEMP °C	APPROX COOK TIME (m)
Biscuits		180-190	1 crk.	170-190	10 - 20
Bread		200-220	1 crk.*	200-220	25 - 30
Bread rolls/buns	Shelf	200-220	1 crk.	200-220	15 - 20
Cakes:	Small & Queen	160-170	1 crk.	180-190	18 - 25
	Sponges	160-170	1 crk.	160-170	18 - 20
	Victoria Sandwich	160-170	1 crk.	160-170	18 - 25
	Madeira	140-150	1 crk.	140-150	1¼ - 1½h
	Rich Fruit	130-140	1 crk.	130-140	2¼ - 2½h
	Christmas	130-140	1 crk.	130-140	3 - 4½h
					depends on size
	Gingerbread	140-150	1 crk.	140-150	1¼ - 1½h
	Meringues	80-100	1 crk.	90-100	2½ - 3h
	Flapjack	170-180	1 crk.	170-180	25 - 30
	Shortbread	130-140	1 crk.	140-150	45 - 65
Casseroles:	Beef/lamb	140-160	1 crk.*	140-160	2½ - 3h
	Chicken	180-190	1 crk.*	180-190	1¼ - 1½h
Convenience Foods		Follow manufacturer's instructions			
Fish	that oven	170-190	1 crk.	170-190	20 - 30
Fish Pie (Potato Topped)		190-200	1 crk.*	190-200	20 - 25
Fruit Pies, Crumbles		190-200	1 crk.	190-200	40 - 50
Milk Puddings	shelves are	130-140	1 crk.	140-150	1½ - 2h
Pasta, Lasagne etc.		190-200	1 crk.	170-180	40 - 45
Pastry:	Choux	190-200	1 crk.	180-190	30 - 35
	Eclairs, Profiteroles	170-180	1 crk.	170-180	20 - 30
	Flaky/Puff Pies	210-220	1 crk.*	210-220	25 - 40
Shortcrust	Mince Pies	190-200	1 crk.	190-200	15 - 20
	Meat Pies	190-210	1 crk.*	190-210	25 - 35
	Quiche, Tarts, Flans	180-210	1 crk.	180-200	25 - 45
Patés and Terrines		150-160	1 crk.	150-160	1-1½h
Roasting Meat, Poultry	when more	160-180	1 crk.*	160-180	see roasting chart
Scones		210-220	1 crk.	220-230	8 - 10
Shepherd's Pie		190-200	1 crk.*	190-200	30 - 40
Soufflés	than one is	170-180	1 crk.	170-180	20 - 30
Vegetables:	Baked Jacket Potatoes	180-190	1 crk.	180-190	1-1½h
	Roast Potatoes	180-190	1 crk.	180-190	1-1½h
	Stuffed Marrow	180-190	1 crk.	180-190	30 - 35
	Stuffed Tomatoes	180-190	1 crk.	180-190	15 - 20
Yorkshire Puddings:	Large	210-220	1 crk.	200-210	25 - 40
	Individual	200-210	1 crk.	200-210	15 - 25

crk. = cranked shelf

\* or on a straight shelf on the oven base.

Note : Shelf positions are counted from the bottom of the oven  
Do not use the cranked shelf from the grill in the main oven.

## DEFROSTING

### USES OF DEFROST FEATURE

This main oven function defrosts most foods faster than more conventional methods. It is particularly suitable for delicate frozen foods which are to be served cold, e.g. cream filled gateaux, cakes covered with icings or frostings, cheesecakes, biscuits, scones, etc.

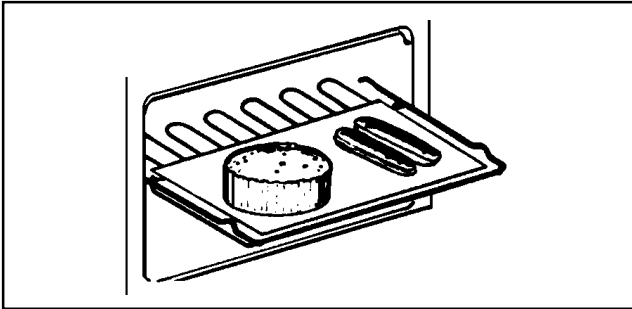

It is preferable to thaw fish, meat and poultry slowly in the fridge. However, this process can be accelerated by using the defrost function.

### SELECTING DEFROST (DORSET/ DEVON).

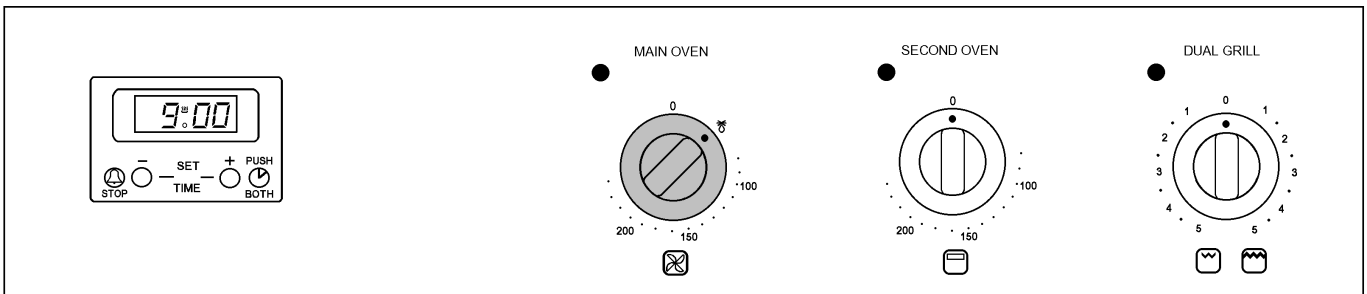

- Turn the main oven temperature control to the defrost setting (☒).
- This function **DOES NOT** require a temperature setting on the oven temperature control.

### THINGS TO NOTE

1. Care must always be taken when handling foods in the home. Always follow the basic rules of food hygiene to prevent bacterial growth and cross contamination when defrosting, preparing, cooking, cooling and freezing foods.
2. The oven fan and internal oven light will come on.
3. The cooling fan does not operate.

Small or thin fish fillets, frozen peeled prawns, cubed or minced meat, liver, thin chops, steaks etc., can be thawed in 1 - 2 hours.

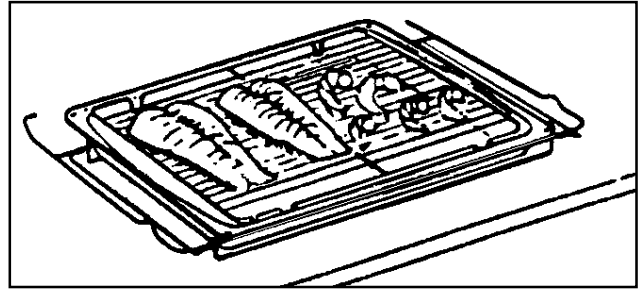

A 1kg/2¼lb oven ready chicken will be thawed in approximately 5 hours. Remove the giblets as soon as possible during the thawing process.

Joints of meat up to 2kg/4½lb in weight can be thawed using the defrost function.

**ALL JOINTS OF MEAT AND POULTRY MUST BE THAWED THOROUGHLY BEFORE COOKING.**

**ALWAYS COOK THOROUGHLY IMMEDIATELY AFTER THAWING.**

### HINTS AND TIPS

- Place the frozen food in a single layer where possible and turn it over half way through the defrosting process.

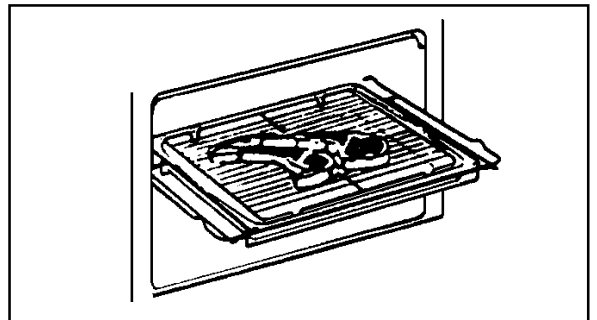

- The actual speed of defrosting is influenced by room temperature. On warm days defrosting will be faster than on cooler days.
- **DO NOT** leave food at room temperature once it is defrosted. Cook raw food immediately or store cooked food in the fridge.

## HELPFUL HINTS WHEN BUYING AND PREPARING FOOD

Care must be taken when handling foods in the home. Always follow the basic rules of food hygiene to prevent bacterial and microbial growth and cross contamination when preparing, reheating, cooking, cooling, defrosting and freezing foods:-

1. Always ensure food you purchase is of good quality and in prime condition. Shop at a reliable source and buy the 'freshest' looking package - avoid shop-worn labels or produce covered in dust.
2. Avoid buying chilled or frozen products if you cannot store them straight away. The use of an insulated container when shopping is advisable.
3. Buy and consume foods prior to the 'Sell by' or 'Best Before' date.
4. When you arrive home, place perishable foods in the refrigerator or freezer immediately. Ensure they are well covered to prevent them drying out and to prevent any possible cross contamination with bacteria from raw to cooked foods.
5. Follow the cooking instructions on packets of prepacked and cook chill foods, but be prepared to adjust cooking time and temperatures to suit your particular oven. For example, the fan oven generally requires 20-25°C lower temperature than conventional ovens.
6. Always ensure that ready prepared meals and cook chill foods are thoroughly re-heated until they are piping hot throughout.
7. It is preferable to defrost frozen foods slowly in the refrigerator. Alternatively, a microwave cooker or the Defrost function on your oven may be used.
8. Always cook defrosted foods immediately after thawing. Thawed food should never be refrozen.
9. Joints of meat and poultry should be thoroughly defrosted before cooking.

10. Cook meat thoroughly - use a meat thermometer if preferred, which penetrates the joint to check that the centre temperature has reached the required temperature (see table below).

MEAT	TEMPERATURES
Beef	Rare - 60°C Medium - 70°C Well Done - 80°C
Pork	Well Done - 80°C
Lamb	Medium - 70°C Well Done - 80°C

11. If not eaten straightaway after cooking, food should be cooled as quickly as possible (within one hour) and then refrigerated or frozen as required. (**Do not** put hot food into a Refrigerator or Freezer).
12. In the kitchen keep work tops, chopping boards and utensils clean with hot soapy water between preparation stages. Ideally, keep one chopping board for raw meat and another for other foods. Keep your dish cloths and tea towels clean.



## CARE AND CLEANING

**BEFORE CLEANING ALWAYS ALLOW THE COOLING FAN TO COOL THE COOKER DOWN BEFORE SWITCHING OFF AT THE ELECTRICITY SUPPLY**

### CLEANING MATERIALS

Before using any cleaning materials on your cooker, check that they are suitable and that their use is recommended by the manufacturer.

Cleaners that contain bleach should NOT be used as they may dull the surface finishes. Harsh abrasives should also be avoided.

### CLEANING THE OUTSIDE OF THE COOKER

DO NOT use abrasive cleaning materials or scourers on the outside of the cooker, as some of the finishes are painted and damage may occur. Regularly wipe over the control panel, oven doors and cooker sides using a soft cloth and liquid detergent.

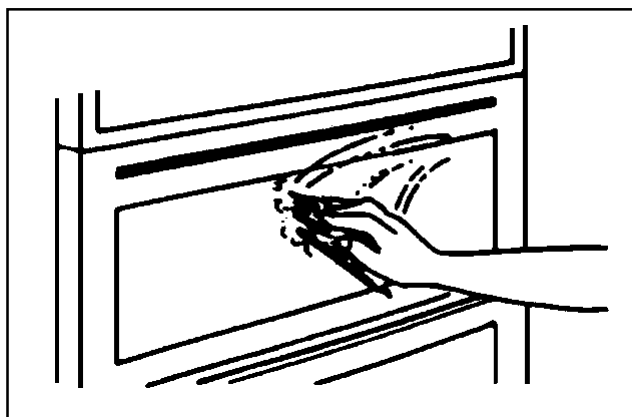

**DO NOT ATTEMPT TO REMOVE ANY OF THE CONTROL KNOBS FROM THE PANEL AS THIS MAY CAUSE DAMAGE AND IS A SAFETY HAZARD.**

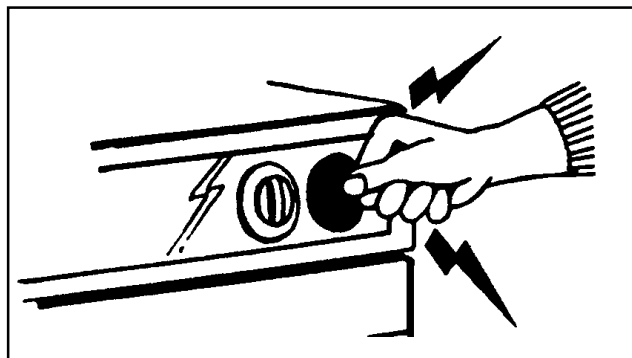

### CLEANING INSIDE THE OVENS

The Stayclean surface inside the ovens should not be cleaned manually. (Devon only). See page 34 "Care of Stayclean Surfaces".

**Aerosol cleaners must not be used on Stayclean surfaces and must not come into contact with elements or the door seal as this may cause damage.**

The vitreous enamel oven base (Devon) and the oven interior (Dorset only) can be cleaned using normal oven cleaners or aerosol oven cleaners with care. Ensure that the manufacturers instructions are followed and that all parts are well rinsed afterwards.

### CLEANING THE GRILL DEFLECTOR, GRILL PAN, GRILL PAN GRID AND OVEN SHELVES

All parts, except the grill pan handle can be washed in the dishwasher. Alternatively, soak them in hot soapy water if they are heavily soiled. They will then clean more easily.

The grill pan/meat tin and grill deflector may be cleaned using a soap impregnated steel wool pad. The grill pan grid and oven shelves should be cleaned using hot soapy water. Soaking first in soapy water will make cleaning easier.

### CLEANING BETWEEN THE OUTER AND INNER DOOR GLASS

The outer door glass is removable for cleaning.

#### TO REMOVE THE OUTER GLASS

1. Open the oven door slightly to gain access to the two cross head screws on the top of the oven door.
2. Loosen the two screws using a pozidrive screwdriver.
3. Hold the door glass securely with one hand, before removing the screws completely with the other hand.
4. Using both hands, gently tilt the top of the door glass towards you. Lift slightly to disengage the locators from the two bottom brackets. As you do this the door will close.

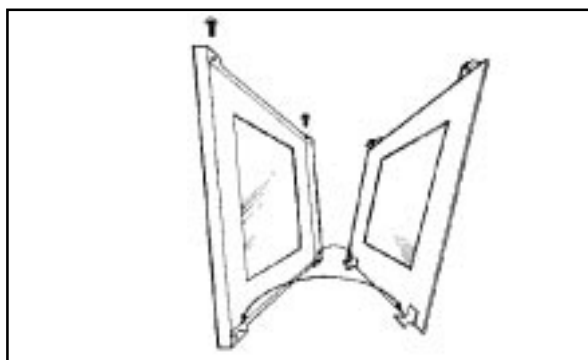

5. Clean the outer and inner glass using hot soapy water or Flash Cream cleaner. DO NOT try to clean the aluminium foil which is inside the door. The foil is there to help keep the door cool, if it is damaged it will not work. Ensure that all parts are well rinsed and thoroughly dry before attempting to replace the outer door glass.

### TO REPLACE THE OUTER GLASS

1. Holding the oven glass with both hands, gently place the locators into the holes of the brackets at the bottom of the oven door.
2. Push the top of the oven glass towards the oven door ensuring the screw location holes line up.
3. Hold the glass in place at the top of the door. Still holding the glass, carefully open the door and insert the cross head screw into the location holes. Give the screws one turn to ensure the glass is secure.
4. Tighten the screws positively with the pozidrive screwdriver before closing the oven door.

**DO NOT** attempt to use the oven without the glass being in place.

### CARE OF STAYCLEAN SURFACES (DEVON ONLY)

Stayclean surfaces destroy splashes of food and fats when the oven temperature is raised to around 220°C.

It is a good idea to run the oven for an hour or two per week to ensure continued good performance from the Stayclean finish.

### HINTS AND TIPS

- Manual cleaning of Stayclean is not recommended. Damage will occur if oven sprays or abrasives of any kind are used.

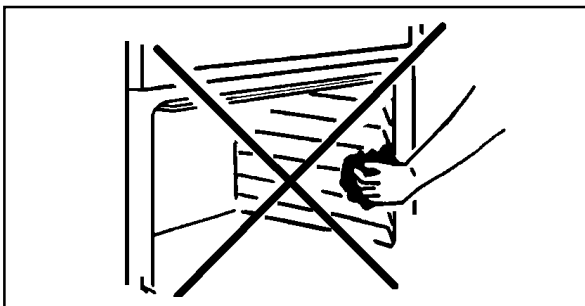

- Slight discolouration and polishing of the Stayclean surface may occur in time. This does not affect the Stayclean properties in any way.

- A good time to allow the oven to run on is after the weekly roast. After removing the roast, turn the oven up to 220°C and allow to run for an hour or so. It is important not to allow a build-up of soilage as this can prevent the Stayclean from working.
- Follow the recommendations below to keep oven soilage to a minimum.
- Cook at the recommended temperatures. Higher temperatures during roasting will increase soilage. Try cooking at lower temperatures for an increased length of time, you will save energy and often the joint is more tender.
- Use minimal, if any, extra oil or fat when roasting meat; potatoes only require brushing with fat before cooking. Extra fat in the oven during roasting will increase splashing and soilage.
- It is not necessary to add water to the meat tin when roasting. The water and the fat juices from the joint create excessive splattering during cooking even at normal temperatures as well as causing condensation.
- Covering joints during cooking will also prevent splashing onto the interior surfaces; removing the covering for the last 20-30 minutes will allow extra browning, if required. Some large joints and turkeys especially benefit by this method of cooking, allowing the joint to cook through before the outside is overbrowned.

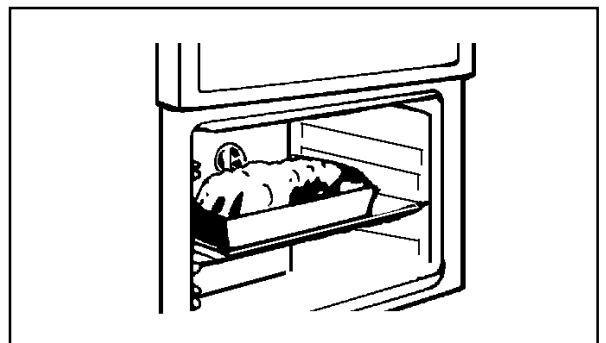

## REPLACING THE OVEN LIGHT BULB

The type of bulb required is a 300C 25 watt small Edison Screw. Part number 572 491 5431-00/1. (Available through Tricity Bendix service centres).

**CAUTION:** DISCONNECT THE COOKER FROM THE ELECTRICITY SUPPLY BEFORE REPLACING THE BULB.

Open door and remove the shelves to enable easy access to the oven light assembly. Insert a flat blade screwdriver between the oven side and the glass which covers the bulb.

Support the glass with your hand and prise out sufficiently to release the glass cover. Unscrew the bulb in an anti-clockwise direction until it is possible to remove the bulb with ease.

Fit the new bulb by turning in a clockwise direction until it is secure. Ensuring the indent to the flange is pointing to the rear of the oven, replace the glass by pushing it firmly into the hole to cover the bulb assembly.

Replace the shelves. Restore the electricity supply and adjust the time of day and clock, as necessary.

## SOMETHING NOT WORKING?

We strongly recommend that you carry out the following checks on your cooker before calling a Service Engineer. It may be that the problem is a simple one which you can solve yourself without the expense of a service call.

If our Service Engineer finds that the problem is listed below you will be charged for the call whether or not the cooker is under guarantee.

### **The grill, oven and timer do not work.**

- \* Check that the cooker has been wired in and is switched on at the wall.
- \* Check that the main cooker fuse is working.

If you have checked the above:

- \* Switch OFF cooker at the wall and allow the appliance to cool for a couple of hours. Switch ON again. The cooker should now be working normally.

### **The grill works but the main oven does not:**

- \* Check that the grill control is in the OFF position.
- \* Switch OFF at the wall to allow the oven to cool. Check that the oven is now working normally.

### **The second oven and grill work but the main oven does not.**

- \* Switch OFF at the wall to allow the oven to cool. Check that the oven is now working normally.

### **The clock and minute minder do not work.**

- \* Check that the operating instructions for the timer are being closely followed.

### **The grill does not work or cuts out after being used for a long period of time.**

- \* Leave the oven to cool for a couple of hours. Check that the grill is now operating normally. Ensure that the door is left open during grilling.
- \* If the cooling fan fails the grill will not work. Contact the Customer Service Centre.

### **The oven temperature is too high or low.**

- \* Check that the recommended temperatures are being used (see page 30). Be prepared to adjust up or down by 10°C to achieve the results you want.
- \* Care should be taken if using an oven thermometer to check oven temperatures as they may be inaccurate.

The following factors should be considered.

- \* Ensure you purchase an accurate good quality instrument.
- \* Ovens will cycle about a set temperature and will not be constant.

### **If the oven is not cooking evenly.**

- \* Check that the cooker is correctly installed and that it is level.
- \* Check that the recommended temperatures and shelf positions are being used.

### **The oven light fails to illuminate.**

- \* Refer to page 35 'Replacing the Oven Light Bulb.'

### **The oven fan is noisy.**

- \* Check that the oven is level.
- \* Check that bakeware and shelves are not vibrating in contact with the back panel in the oven.

## SERVICE AND SPARE PARTS

### HELP US TO HELP YOU

Please determine your type of enquiry before writing or telephoning.

### SERVICE

It is a recommendation by the manufacturer that annual servicing of the product is done by the manufacturers approved service organisation.

In the event of your appliance requiring service Tricity Bendix Limited have an arrangement with Electrolux Group Service.

Before calling out an Engineer, please ensure that you have read the details under the heading 'Something Not Working?' and have the model number and purchase date to hand. The model and serial numbers, which should be quoted in any communication can be found on the rating plate on the lower front frame of the cooker upon opening the oven door. It is advisable to make a note on the back cover of this book for easy reference. The telephone number and address for service is detailed on the list headed 'Customer Service Centres'.

PLEASE NOTE that all enquiries concerning service should be addressed to your local Customer Service Centre.

### CONSUMER CARE DEPARTMENT

**FOR GENERAL ENQUIRIES** concerning your Tricity Bendix cooker or further information on Cooking, Cooling or Washing products, you are invited to contact our Consumer Care Department by letter or telephone as follows:

Consumer Care Department  
Tricity Bendix Limited  
99 Oakley Road  
Luton  
Bedfordshire LU4 9QQ  
Tel: (01582) 585858

## CUSTOMER SERVICE CENTRES

The Regional Electricity Companies are responsible for the servicing of cookers sold by their own outlets. The telephone numbers can be found in the telephone directory.

Service for cookers bought from other outlets can be obtained by calling the nearest Customer Service Centre on the numbers given below. The areas are defined by Postcode for easy reference.

CENTRE	POSTAL DISTRICTS	SERVICE APPOINTMENTS	ADDRESS
ABERDEEN	AB	01224-696569	Electrolux After Sales Service Northeast Appliance Service 8 Cornhill Arcade Cornhill Drive Aberdeen AB2 5UT
ARGYLL	PA 24-61	01369-703161	Electrolux After Sales Service T.D.C. Refrigeration Briar Hill 7 Hill Street Dunoon Argyll PA23 7AL
BARNSTAPLE	EX18-23, 31-39	01271-328826	Electrolux After Sales Service McBain Refrigeration Unit 4 Upcott Avenue Pottington Industrial Estate Barnstaple N.Devon EX31 1HN
BORDERS	TD	01573-224411	Electrolux After Sales Service James Stewart & Son 2-8 Wood Market Kelso Borders TD5 7AX
BRISTOL	BA BS TA SP	0117-9211876	Electrolux After Sales Service Unit BE46 PO Box 372 Bristol BS99 1UD
CANVEY	E EC EN N NW W WC AL CB HA HP LU MK SG UB WD CM CO IG RM SS IP NR PE14-19,30-38	0181-443-3464 0181-965-9699 0181-965-9699 01268-694144 01603-667017	Electrolux After Sales Service 2-4 Sandhurst Kings Road Canvey Island SS8 0QY
CARDIFF	CF NP1-4, 6, 9-44,SA1-18 SA21-32	01222-460131	Electrolux After Sales Service Guardian Industrial Estate Clydesmuir Road Tremorfa Cardiff CF2 2QS
CUMBRIA	CA	01228-594747	Electrolux After Sales Service E.T.B. Services Carlisle Enterprise Centre James Street Carlisle CA2 5AP
DUMFRIES & GALLOWAY	DG1-14	01387-265166	Electrolux After Sales Service Allan Crossan (Service) 93 Irish Street Dumfries Scotland
DUNDEE	Parkinson Cowan Gas Only	01382-642828	Electrolux After Sales Service Tayside Refrigeration 3-7 Blackness Street Dundee DD1 5LR
DUNDEE	DD1-14 PH8-18	01250-876285	Electrolux After Sales Service 1 Brogan Domestic 41 Leslie Street Blairgowrie Perthshire PH10 6AT

GLASGOW	EH FK G KA KY1-16 ML PA1-23, PH1-7	0141-647-4381	Electrolux After Sales Service 20 Cunningham Road Clyde Estate Rutherglen Glasgow G73 1PP
GUERNSEY	All Codes	01481-46931	Guernsey Electricity PO Box 4 Vale Guernsey Channel Islands
HAVERFORDWEST	SA33-39 SA41-44 SA61-73	01437-710914	Electrolux After Sales Service C Butherway 1 Church Road. Roch Haverfordwest Dyfed Wales SA62 6AG
HEREFORD	HR1-9 LD1-8 SY7 ,18 NP5 NP7-8	01432-340334	Electrolux After Sales Service Domestic Repair Centre Unit 3 Bank Buildings Cattle Market Hereford HR4 9HX
HULL	YO4 YO11-18 YO25 HU1-19 DN14	01482-585678	Electrolux After Sales Service John Sizer Unit 1 Boulevard Unit Factory Estate Hull HU3 4AY
INVERNESS	IV1-28, 30-36, 52-56, PH19-26, 42-44 KW1-14	01463-792952	Electrolux After Sales Service Highland Appliances Unit 3B3 Smithton Industrial Est Smithton Inverness
INVERNESS	PH30-41 IV40-51	01855-821315	Electrolux After Sales Service George Ross Electrical Forrestry Workshop Inchree Onich Inverness-shire PH33 6SE
ISLE OF WIGHT	PO30-41	01983-872552	Electrolux After Sales Service Wyatts Electrical Service 4 Forelands Road Bembridge Isle of Wight PO35 5XW
ISLE OF ARRAN	KA27	01770-302909	Electrolux After Sales Service Arran Domestic Unit 4 The Douglas Centre Brodick Isle of Arran KA27 8AJ
ISLE OF MAN	IM	01624-663455	Electrolux After Sales Service Manx Electricity Service Workshop North Quay Douglas Isle of Man
ISLE OF MULL	PA62-75	01688-302262	Electrolux After Sales Service B Hogg Braeside Raeric Road Tobermory Isle of Mull PA75 6PU
JERSEY	ALL CODES	01534-505050	Jersey Electricity Company PO Box 45 Queens Road St Helier Jersey, Channel Islands JE4 8NY
LAMPETER	SA19,20 SA40 SA45-48 SY23-25	01570-423020	Electrolux After Sales Service Lampeter Domestic Appl. Services Unit 16 Lampeter Ind. Est. Lampeter SA48 7DY

LANCASTER	LA1-23	01772-316175	Electrolux After Sales Service NL Services Unit 333 Ranglet Road Walton Summit Bamber Bridge Preston, Lancashire PR5 8AR
LEEDS	BD DN1-7, 10-12, HD HG HX LS S WF YO1-3, 5-8 DE NG1-22 & 25	0113-2608511	Electrolux After Sales Service 64-66 Cross Gates Road Leeds LS15 7NN
LINCOLN	DN21 sub codes 1 2 & 5 only, LN1, 2, 4,5,6 LN3 sub codes 4 & 5 only LN8-10 NG 23,24 31-34 PE1-13, 20-25	01522-514603	Electrolux After Sales Service Brian Hudson Unit 8 Stonefield Park Clifton Street Lincoln LN5 8AA
LIVERPOOL	FY PR L WN CH CW WA (Not WA 14/15)	0151-2541724	Electrolux After Sales Service Unit 1 Honeys Green Precinct Honeys Green Lane West Derby Liverpool L12 9JH
MANCHESTER	BB BL OL M SK WA14 & 15 only	0161-4777758	Electrolux After Sales Service Unit 30 Oakhill Trading Estate Devonshire Road Worsley Manchester M28 3PT
NEWTON ABBOTT	EX1-17 TQ PL1-9, 16, 19-21	01626-65909	Electrolux After Sales Service South West Domestic Service Unit 2 Zealley Industrial Est Kingsteignton Newton Abbott South Devon TQ12 3SJ
NORTH WALES	LL	01745-591616	Electrolux After Sales Service GMS (Cymru) Unit 2 Coed- Parc Abergele Road Rhuddlan Clwyd, Wales LL18 5UG
NORTHERN	DL TS DH YO21, 22 DH NE SR	01325-301400 0191-493-2025	Electrolux After Sales Service PO Box 40 Preston Road Aycliffe Industrial Estate Newton Aycliffe, Co Durham DL5 6XA
NORTHERN IRELAND EAST	BT1-30, 36-57, 63-67	01232-746591	Electrolux After Sales Service Unit C3 Edenderry Industrial Estate 326 Crumlin Road Belfast BT14 7EE
NORTHERN IRELAND WEST	BT31-35, 60-62, 68-82, 92-94	01861-510400	Electrolux After Sales Service G & O (Armagh) Service Owenmore House Kilwee Business Park Upper Dunmurray Lane Belfast BT17 0HD
NUNEATON	B DY ST TF WR WS WV GL NN OX SN CV LE	0121-358-7076 0121-358-5051 01993-704411 01203-350420	Electrolux After Sales Service Unit 23-24 Alliance Business Pk Townsend Drive Nuneaton Warwickshire CV11 6RX
ORKNEY	KW15-17	01856-875457	Electrolux After Sales Service Refrigeration Sales and Services Hatson Ind. Estate Kirkwall Orkney
REDDITCH	TBA	TBA	Electrolux After Sales Service Heming Road Washford Redditch Worcestershire B98 ODH



REDRUTH	TR1-20, 26, 27 PL10-15, 17, 18, 22-35	J1209-314407	Electrolux After Sales Service Cornwall Domestic Service Unit 7D Pool Industrial Estate Wilson Way Redruth Cornwall TR15 3QW
ROTHSAY	PA20	01700-504777	Electrolux After Sales Service D McGlashan Walker Walker Engineering Glenmhor Upper Serpentine Rothesay PA20
SHETLAND	Own Sales	01595-692225	Electrolux After Sales Service Tait Electronic Systems Ltd. Holmsgarth Road Lerwick Shetland ZE1 OPW
SHETLAND	Own Sales	01595-692855	Electrolux After Sales Service Bolts Shetland Ltd. 26 North Road Lerwick Shetland ZE1 OPE
SHETLAND	ZE2	01806-566546	Electrolux After Sales Service Leask Electrical Harsdale Symbister Shetland ZE2 9AA
SHREWSBURY	SY1-6 SY8-17 SY19-22	01743-450279	Electrolux After Sales Service BLI Service 6 Harlescott Barn Harlescott Lane Shrewsbury SY1 3SY
SOUTH COAST	BN16-18. GU27-35 PO1-22. BH DT SO TR21-25	01705-667411 01705-667411 0117-9211876	Electrolux After Sales Service Limerline Road Hilsea Portsmouth Hampshire PO3 5JJ
SOUTH HUMBERSIDE	DN 8, 9, DN15-20 DN21 sub codes 3,4 only DN31-40 LN (3 sub code 6 only), 7 LN11-13	01472-267978	Electrolux After Sales Service John Robinson (Electrical) Unit 74 New Enterprise Centre King Edward Street Great Grimsby DN31 3JP
TONBRIDGE	SL GU1-26. RG CT DA ME TN BN1-15, 20-27, RH TW BR CR SE SW SM KT	01252-24505 01732-357722 01273-694341 0181-658-9069	Electrolux After Sales Service Unit 30 Deacon Trading Estate Morley Road Tonbridge Kent TN9 1RA

**We, Tricity Bendix, undertake that if within 12 months of the date of the purchase this Tricity Bendix appliance or any part thereof is proved to be defective by reason only of faulty workmanship or materials, we will, at our option repair or replace the same FREE OF ANY CHARGE for labour, materials or carriage on condition that:**

- The appliance has been correctly installed and used only on the electricity supply stated on the rating plate.
- The appliance has been used for normal domestic purposes only and in accordance with the manufacturers operating and maintenance instructions.
- The appliance has not been serviced, maintained, repaired, taken apart or tampered with by any person not authorised by us. Any servicing or repairs carried out by any unapproved third party will invalidate the approvals status of this product.
- All service work under this guarantee must be undertaken by a Tricity Bendix service representative or authorised agent.
- Any appliance or defective part replaced shall become the Company's property.
- This guarantee is in addition to your statutory and other legal rights.

### EXCLUSIONS

**This guarantee does not cover:**

- Damage or calls resulting from transportation, improper use or neglect, the replacement of any light bulbs or removable parts of glass or plastic.
- Cost incurred for calls to put right an appliance which is improperly installed or calls to appliances outside the United Kingdom.
- Appliances found to be in use within a commercial environment, plus those which are subject to rental agreements.
- Products of Tricity Bendix manufacture which are not marketed by Tricity Bendix.
- EEC Countries. The standard guarantee is applicable but subject to the owners responsibility and cost to ensure the appliance meets the standards set by the Country of which the product is taken. Electrolux Aftersales Service in the Country concerned, with whom Tricity Bendix have an arrangement, will be pleased to advise further.



## RATING PLATE REFERENCE

MAKE AND MODEL NO.	SERIAL NO.	DATE OF PURCHASE

### IMPORTANT NOTICE

In line with our continuing policy of research and development, we reserve the right to alter models and specifications without prior notice.

This handbook is accurate at the date of printing, but will be superseded and should be disregarded if specifications or appearance are changed.

# TRICITY BENDIX



Better Products. Better Value.

TRICITY BENDIX, 99 OAKLEY ROAD, LUTON, BEDFORDSHIRE, LU4 9QQ

A Division of Emaco Limited . Registered in England No. 176547 . Registered Office. 101 Oakley Road, Luton LU4 9RJ.

MODEL NO.  
**ATB 4411/4421**  
**ATB 4511/4521**



PART NO.  
**311265006**

## Free Manuals Download Website

<http://myh66.com>

<http://usermanuals.us>

<http://www.somanuals.com>

<http://www.4manuals.cc>

<http://www.manual-lib.com>

<http://www.404manual.com>

<http://www.luxmanual.com>

<http://aubethermostatmanual.com>

Golf course search by state

<http://golfingnear.com>

Email search by domain

<http://emailbydomain.com>

Auto manuals search

<http://auto.somanuals.com>

TV manuals search

<http://tv.somanuals.com>