



# OPERATING AND INSTALLATION INSTRUCTIONS

MODEL NO.  
**RE50M**

## TECHNICAL DETAILS

### MODEL NO. RE50M

Voltage: 230/240 Volts AC 50Hz

Wattage: 9.8/10.7kW

Height: 900mm

Width: 500mm

Depth: 600mm

This appliance complies with: European Council Directive 73/23/EEC.  
EMC Directive 89/336/EEC.  
CE Marking Directive 93/68/EEC.

# CONTENTS

<b>Technical Details</b> .....	2
<b>Contents</b> .....	3
<b>Preface</b> .....	5
<b>Safety</b> .....	6
Before Installation .....	6
During Operation .....	6
After Use .....	7
General .....	7
<b>Introduction</b> .....	8
Rating Plate .....	8
Installation .....	8
General Notes on Using Your Cooker .....	9
Control Panel Indicator Neon .....	9
About Condensation and Steam .....	9
Grill and Oven Furniture .....	9
<b>Getting to know your Cooker</b> .....	10
The Control Panel .....	10
<b>The Sealed Hotplates</b> .....	11
Recommended Saucepans .....	11
Hints and Tips .....	11
Deep Fat Frying .....	12
Preserving .....	12
<b>The Grill</b> .....	13
Uses of the Grill .....	13
Selecting the Grill .....	13
Things To Note .....	13
The Grill Pan and Handle .....	13
Hints and Tips .....	14
Grilling Chart .....	14
<b>The Fan Oven</b> .....	15
Uses of the Fan Oven .....	15
Selecting the Fan Oven .....	15
Things To Note .....	15
To Fit the Oven Shelves .....	15
Hints and Tips .....	16
<b>Oven Cooking Chart</b> .....	17
<b>Roasting Chart</b> .....	18

# CONTENTS

<b>Defrosting</b> .....	19
Uses of Defrost Feature .....	19
Selecting Defrost .....	19
Things to Note .....	19
Hints and Tips .....	19
<b>Care and Cleaning</b> .....	20
Cleaning Materials .....	20
Cleaning the Sealed Hotplates and Hotplate trims .....	20
Cleaning the Vitreous Enamel .....	20
Cleaning the Outside of the Cooker .....	20
Cleaning the Grill Pan, Grill Pan Grid and Oven Shelves .....	21
Cleaning Inside the Oven and Grill Compartments .....	21
Care of Stayclean Surfaces .....	21
Hints and Tips .....	21
<b>Something not Working?</b> .....	22
<b>Service and Spare Parts</b> .....	23
<b>Customer Service Centres</b> .....	24
<b>Guarantee Conditions</b> .....	26

## PREFACE

Dear Customer,

Thank you for buying a Tricity Bendix cooker. With our experience in developing and manufacturing the very best in U.K. cookers, you can be assured that you have purchased a hard working, reliable, quality product.

Tricity Bendix cookers comply with British Standard safety and performance requirements. They have been approved by BEAB (British Electrotechnical Approvals Board) and are covered by a 12 month parts and labour guarantee.

To get the best from your new Tricity Bendix cooker, we ask that you PLEASE READ THESE INSTRUCTIONS CAREFULLY. Particular attention should be made to cooking times and temperatures which may differ from your previous cooker.

It is most important that this instruction book is retained with the appliance for future reference. Should the appliance be sold, or if you move house and leave the appliance, always ensure that the book remains with the appliance. This will enable the new owner to be acquainted with the functioning of the appliance and the relevant warnings.

Please read the whole instruction book before attempting to use the appliance ensuring you follow the recommendations given.

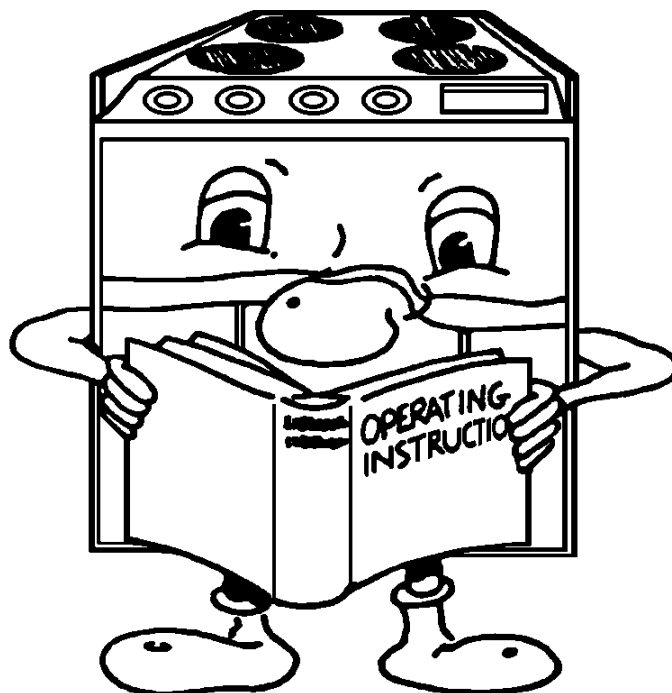

# SAFETY

THESE WARNINGS ARE PROVIDED IN THE INTERESTS OF YOUR SAFETY. ENSURE THAT YOU UNDERSTAND THEM ALL BEFORE INSTALLING OR USING THE COOKER.

PLEASE  
READ  
CAREFULLY



## BEFORE INSTALLATION



This cooker is heavy and care **must** be taken when moving it.



**Ensure** that all packaging, both inside and outside the cooker has been removed before the appliance is used.

If the cooker is to be placed on a base, measures must be taken to prevent the cooker slipping from the base.



**Do not** try to move the cooker by pulling the door handles.



The electrical installation work **must** be undertaken by a qualified electrician/ competent person.

**It is dangerous** to alter or modify the specifications of the cooker in any way.



After installation, please dispose of the packaging with due regard to safety and the environment.

## DURING OPERATION



**Do not** use this cooker if it is in contact with water. **Never** operate it with wet hands.



This cooker is designed to be operated by adults. Young children **must not** be allowed to tamper with the cooker or play with the controls.

During use the cooker becomes Hot. Care should be taken to avoid touching heating elements inside the oven.

Accessible parts especially around the grill area may become hot when the cooker is in use. Children should be **kept away** until it has cooled.

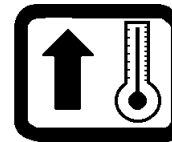

Take **great care** when heating fats and oils as they will ignite if they become too hot.

This cooker has been designed for cooking edible foodstuffs only, and **must not** be used for any other purposes.



**Never** place plastic or any other material which may melt in the oven or on the hob.



**Ensure** cooking utensils are large enough to contain foods to prevent spillages and boil overs.

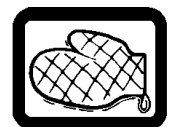

The handles of saucepans which are smaller than the heated area on the hob will become hot. **Ensure** your hand is protected before handling the pan.



**Take care** to follow the recommendations given for tending the food when grilling.



**Do not** leave the grill pan handle in position when grilling as it will become hot.

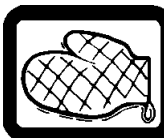

**Always** use oven gloves to remove and replace the grill pan handle when grilling. Recommendations given on page 13.

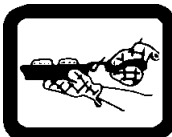

**Ensure** that you support the grill pan when it is in the withdrawn or partially withdrawn position.

**Ensure** that all vents are left unobstructed to ensure ventilation of the oven.

**Ensure** that the anti-tilt shelves are put in place correctly. Refer to instructions on page 15.

**Never** line any part of the cooker with aluminium foil.



**Always** stand back from the cooker when opening the oven door to allow any build up of steam or heat to release.



**Do not** place sealed cans or aerosols inside the oven. They may explode if they are heated.

**Do not** leave the hotplates switched ON for long periods when not covered by a saucepan. The controls and cabinets may overheat.

## AFTER USE



**Ensure** that all control knobs are in the OFF position when not in use.



For hygiene and safety reasons this cooker should be kept clean at all times. A build-up of fats or other foodstuffs could result in a fire, especially in the grill pan.



**Do not** leave utensils containing foodstuffs, e.g. fat or oil in or on the cooker in case it is inadvertently switched ON.

Cookers and hobs become **very hot**, and retain their heat for a long period of time after use. Children should be kept well away from the cooker until it has cooled.

## GENERAL



**Under no circumstances** should repairs be carried out by inexperienced persons as this may cause injury or serious malfunction. This cooker should be serviced by an authorised Service Engineer and only genuine approved spare parts should be used.



**Do not** stand on the cooker or on the open oven door.



**Do not** hang towels, dishcloths or clothes from the cooker or its handle. They are a safety hazard.



Only clean this cooker in accordance with the instructions given in this book.

Your safety is of paramount importance.

Therefore, if you are unsure about any of the meanings of these WARNINGS contact the:

Customer Care Department  
Telephone 0870 5 950950

# INTRODUCTION

## WARNING: THIS COOKER MUST BE EARTHED

### RATING PLATE

Record the model, product and serial numbers on the back cover from the rating plate. This is situated on the lower front frame of the cooker and can be seen upon opening the grill door.

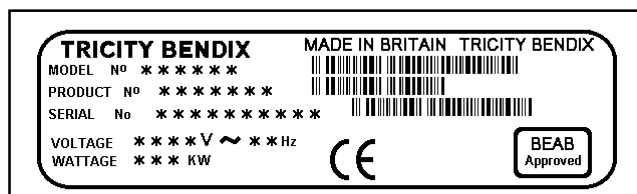

The cooker must be protected by a suitably rated fuse or circuit breaker. The rating of the cooker is given on the rating plate.

**Do not remove the rating plate from the cooker as this may invalidate the guarantee.**

### INSTALLATION

If your cooker has been damaged in transit, contact your supplier immediately. **DO NOT** attempt to install it.

Your cooker left the factory fully packaged to protect it from damage. If it is delivered without packaging and damage has occurred, the manufacturer cannot accept responsibility. Contact your supplier for advice.

Once the packaging has been removed the cooker should only be moved by hand. **DO NOT** use a sack barrow or any other aid to lift the cooker as damage may occur.

Connection to the electricity supply must be carried out by a qualified electrician/competent person.

The electrical connection should be made using a double pole isolating switch (cooker socket) with at least 3mm contact separation. The cable must have conductors of sufficiently high cross-sectional area to prevent overheating and deterioration.

Six square millimetres (6.00mm<sup>2</sup>) is the recommended cross-section area.

The cable should be routed away from potentially hot areas marked by X in the diagram below.

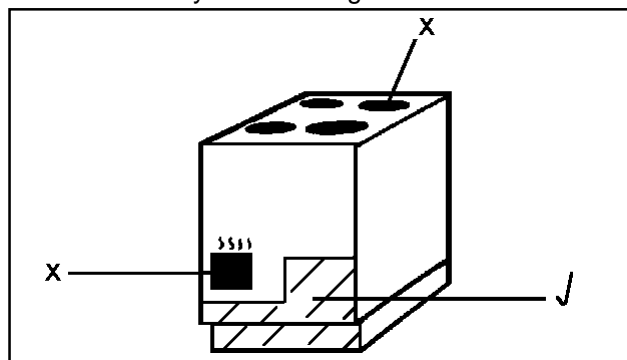

To move the cooker, open the fan oven door, and lift the cooker by holding inside the top of the compartment.

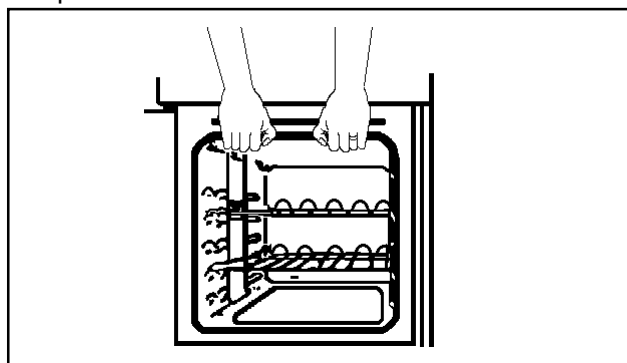

This is a type X appliance which means it is free-standing and can be fitted with cabinets on one or both sides. It may also be fitted in a corner setting.

Ensure that the cooker is standing level.

Side walls which are above hob level should be protected by heat resistant non-combustible material and **MUST NOT** be nearer than 40mm to the hob side.

A nominal air gap of 2mm all around the cooker is required to enable the cooker to be moved into position. It is recommended that proprietary trims are fitted to protect the worktops of either side of the appliance. These are available from most DIY stores.

Always ensure an air gap is maintained at hotplate level. Tiles or other forms of deep wall covering should not obscure this gap.

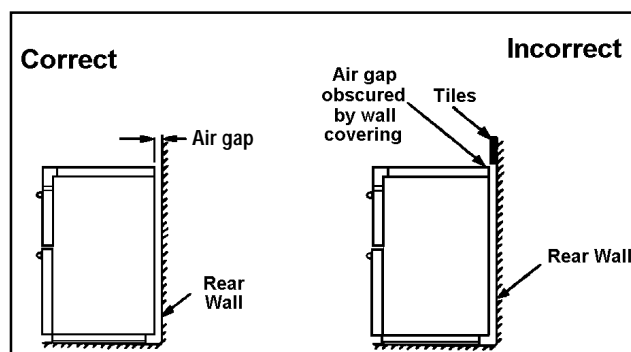



Note: Vapours from the oven vent may in time cause discolouration of wallcoverings behind the cooker. For ease of cleaning it may be preferable to tile behind the cooker.

Overhanging surfaces or a cooker hood should be a minimum of 685mm above the hob.

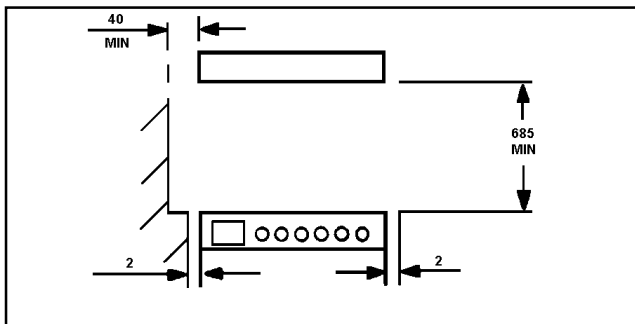

It is important to ensure that the appliance is level after installation. Levelling feet are fitted to the front of the appliance to accommodate uneven floors.

## GENERAL NOTES ON USING YOUR COOKER

We suggest that you run the oven elements for 10 - 15 minutes at 220°C to burn off any residue from their surfaces.

The procedure should be repeated with the grill for approximately 5 - 10 minutes.

During this period an odour may be emitted, it is therefore advisable to open a window for ventilation.

## OVEN INDICATOR NEON

The light will indicate whether the oven is switched on, the neon also indicates when the set temperature has been reached. The neon will turn on and off during use to show that the temperature is being maintained.

## ABOUT CONDENSATION AND STEAM

When food is heated it produces steam similar to a boiling kettle. The ovens are vented to allow some of this steam to escape. However, always stand back from the cooker when opening the oven door to allow any build up of steam or heat to release.

If the steam comes into contact with a cool surface on the outside of the cooker, e.g. a trim, it will condense and produce water droplets. This is quite normal and is not caused by a fault on the appliance.

To prevent discolouration, regularly wipe away condensation and also soilage from surfaces.

## GRILL AND OVEN FURNITURE

The following items of grill and oven furniture have been supplied with the cooker.

1 grill pan



1 grill pan handle

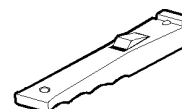

1 grill pan grid

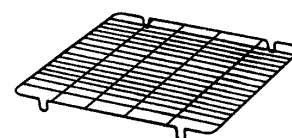

1 straight shelf for grilling only



2 straight shelves for main oven cooking



# GETTING TO KNOW YOUR COOKER

## THE CONTROL PANEL

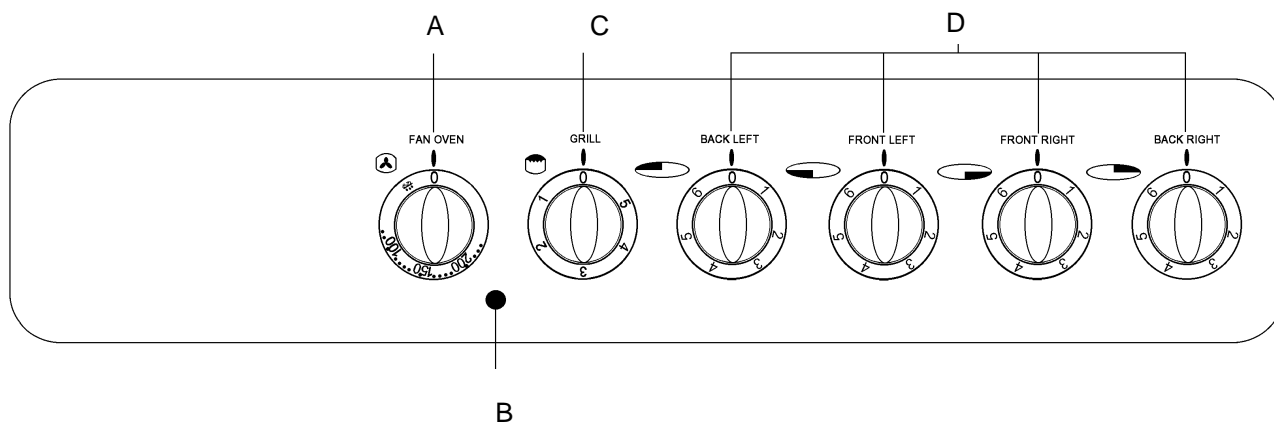

### FEATURES

- A - Fan Oven Control
- B - Fan Oven Indicator Neon
- C - Grill Control
- D - Hotplate Controls

## THE SEALED HOTPLATES

### BEFORE USING THE HOTPLATES FOR THE FIRST TIME

Turn the control knob to a medium/high setting and allow the hotplate to heat uncovered by a saucepan for 3-5 minutes. This hardens the protective coating on the hotplates and makes it more resistant to normal use. A harmless smoke will be given off from the hotplates.

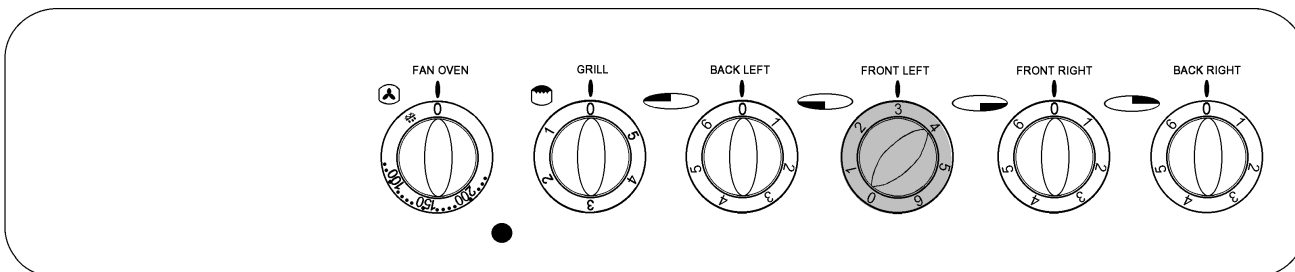

- To operate the hotplates turn the control knobs in either direction to vary the heat setting.
- The highest number represents the hottest setting and the lowest represents the coolest setting. Choose a setting appropriate to the quantity and type of food to be cooked.

### RECOMMENDED SAUCEPANS

For speed and economy only good quality saucepans with flat bases and close fitting lids are recommended.

To check the flatness of the saucepan place a ruler across the pan base, hold at eye level and look for light showing. There should be very little or no light visible between the ruler and the pan base.

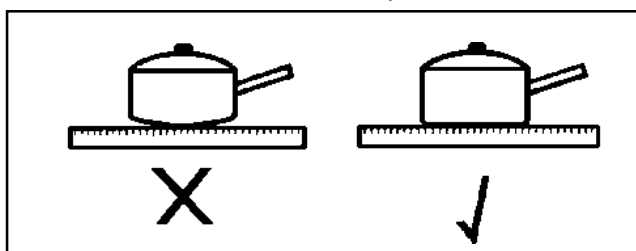

The size of the base of the saucepan should be the same or up to 3cm/1 inch larger than the hotplate. If the base is too small energy will be wasted, boilovers will also be more difficult to deal with as spillage will fall directly onto the hotplate.

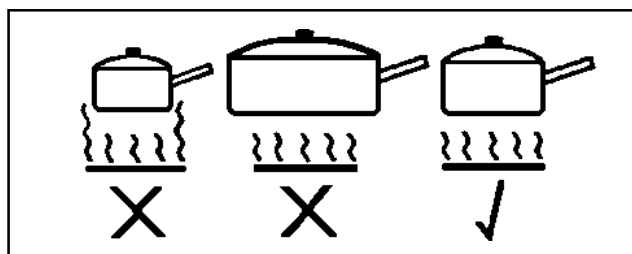

Pressure cookers, preserving pans etc., should comply with the recommendations given above.

Traditional round bottomed Woks **must not** be used even with a stand. Woks with flat-bottomed bases are available and do comply with the above recommendations.

### HINTS AND TIPS

- Avoid the use of decorative covers as they can cause condensation to form on the hotplates which may lead to deterioration.
- Follow any guidelines provided by the saucepan manufacturer, particularly those relating to recommended heat settings.
- Avoid using thin, badly dented or distorted saucepans as they can lead to sticking and burning of food.
- To prolong the life of the hotplates:
  - Never use utensils with a skirt, e.g. a bucket
  - Never use an asbestos mat

## DEEP FAT FRYING

### SPECIAL FRYING NOTE:

For safety purposes when deep fat frying, fill the pan one-third full of oil, DO NOT cover the pan with a lid and DO NOT leave the pan unattended. In the unfortunate event of a fire, switch the cooker OFF at the electricity supply and cover the pan with a lid or damp cloth to assist in smothering the flames.

DO NOT use water on the fire. Leave the pan to cool for at least 30 minutes before moving it.

DO NOT leave the fat or oil in the frying pan on the hob to store it in case the hob is inadvertently switched ON.

#### 1. Preparing the food

Seal the food by coating with flour, egg and breadcrumbs or batter. **Do not** use a basket with batter coated foods as they will stick.

#### 2. Amount of oil

For safety purposes fill the pan only one-third full of oil.

#### 3. Testing the temperature of the oil

It is advisable to use a thermometer to test the temperature of the oil. Alternatively, drop a small cube of bread into the oil which should brown in just under a minute if the oil is at the correct temperature of 190°C/375°F.

#### 4. Cooking the food

Lower the food gently into the oil. **Do not** add too much food at once or the temperature of the oil will be reduced and may result in soggy, greasy food.

Turn the food if necessary; doughnuts float to the surface so will not brown on the upperside if not turned. Once cooked, drain the food on absorbent paper.

#### 5. Double frying chips

Double frying will ensure good chips. First fry the chips for a few minutes at 170°C/340°F to seal the outside. Remove the chips from the oil. Increase the temperature of the oil to 190°C/375°F to finish cooking and brown the chips.

Chips may be kept for several hours after the first frying before finishing off with the second frying.

#### 6. Frying temperatures

	Celsius Scale (°C)	Fahrenheit Scale (°F)
	150	300
First frying of potatoes	<b>170</b> 175 180	<b>340</b> 350 360
Second frying of potatoes	<b>190</b>	<b>375</b>
Frying chicken and fish	195 200	380 390

## PRESERVING

1. DO NOT use a pan that overlaps the perimeter of the hob trim.

2. To allow for a full rolling boil, the pan should be no more than one third full when all the ingredients have been added. It is better to use two pans rather than overfill one, or use half quantities.

3. Use firm fruit or vegetables and wash well before using.

4. Preserving sugar gives clear jam, however granulated sugar is cheaper and gives equally good flavour.

5. Crystallization may be caused if sugar is not completely dissolved before bringing jam to the boil. Over boiling will affect the flavour, setting properties and colour of the jam.

6. To test jam for setting:

If a jam thermometer is available, boil jam to 104°C. Marmalade should be boiled to 106°C.

If a jam thermometer is not available, remove pan from heat, place sample of jam on a cold dish and cool quickly (i.e. in a freezer or frozen food storage compartment of a refrigerator). When cold, it will crinkle and hold the mark of a finger run through it, if it is at setting point.

7. The scum should be removed as soon as possible from the surface of the preserve after setting point has been reached. Marmalade should be allowed to cool before potting to prevent the peel rising.

## THE GRILL

### USES OF THE GRILL

**CAUTION - ACCESSIBLE PARTS MAY BECOME HOT WHEN THE GRILL IS IN USE. CHILDREN SHOULD BE KEPT AWAY.**

### SELECTING THE GRILL

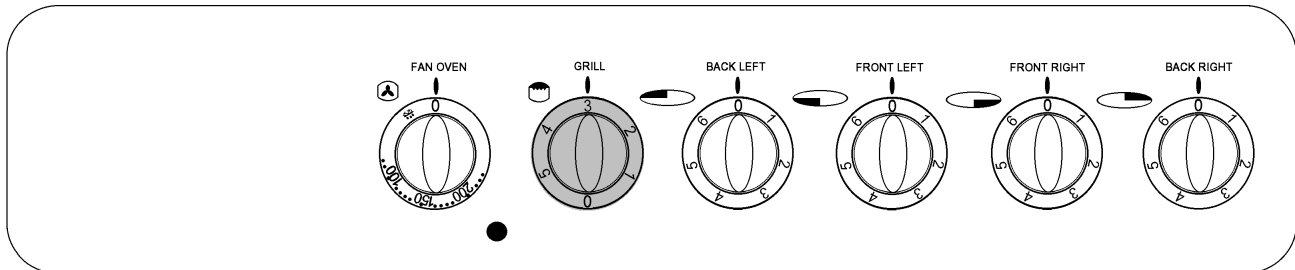

- To operate the grill open the grill door and turn the grill control in either direction.
- The highest number represents the hottest setting and the lowest the coolest setting.
- Setting 5 represents the grill on Full. At lower settings the grill may turn on and off over time and you may prefer to use these settings for keeping food warm.

### THINGS TO NOTE

THE GRILL DOOR MUST BE LEFT OPEN DURING GRILLING.

Closing the grill door will cut OFF the power to the grill element preventing incorrect use.

Some smoke from fat splashes may be evident as the grill cleans itself.

### THE GRILL PAN AND HANDLE

The grill pan is supplied with a removable handle.

To insert the handle, press the button on the handle with the thumb and pivot the handle slightly upwards inserting the lip into widest part of the bracket. Move the handle towards the left, lower into position and release the button.

**Ensure the handle is positively located.**

When removing the handle, press the button on the handle with the thumb and pivot the handle slightly upwards and towards the right to remove from the bracket.

**Ensure your hand is protected when removing the grill pan handle as the grill element can become very hot.**

**ALWAYS REMOVE THE GRILL PAN HANDLE DURING GRILLING.**

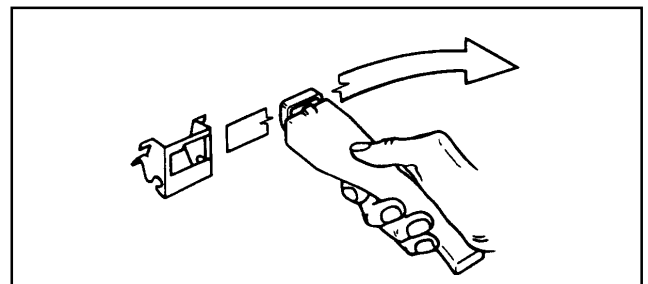

To correctly locate the grill pan on the shelf, ensure that the cut out on the underside of the handle bracket locates over the front bar of the shelf.

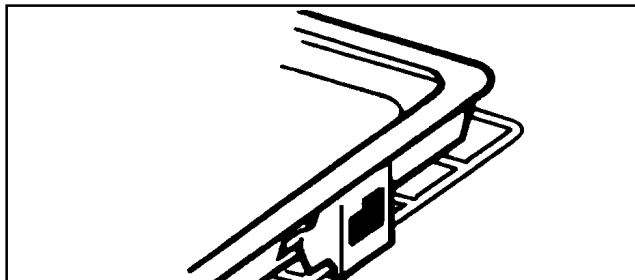

To check the progress of the food being grilled, the grill pan should be withdrawn on the shelf to attend to food during cooking or the carrier shelf can be lifted away from the cooker and rested on a heat resistant work surface.

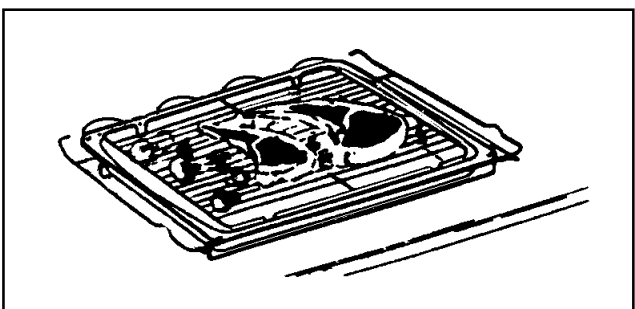

### HINTS AND TIPS

- Food should be thoroughly dried before grilling to minimise splashing. Brush lean meats and fish lightly with a little oil or melted butter to keep them moist during cooking.
- Adjust the grill pan runner position to allow for different heights of food.

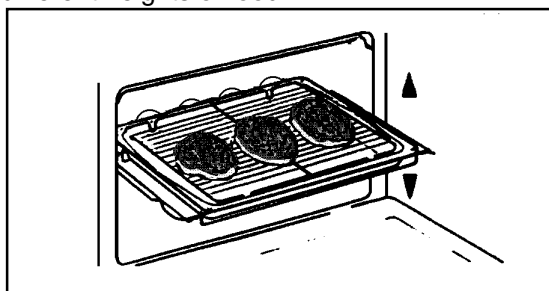

- Accompaniments such as tomatoes and mushrooms may be placed underneath the grid when grilling meats.

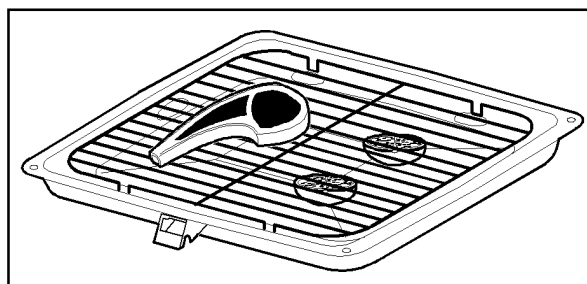

- When toasting bread use the shelf in position 1 with the grid in the high position.

- Preheat the grill on a full setting for a few minutes before searing steaks or toasting. Adjust the heat setting and the shelf as necessary during cooking.
- The food should be turned over during cooking as required.

### GRILLING CHART

FOOD	SHELF	GRILL TIME (mins)
Bacon Rashers	1	2-3 each side
Beefburgers	1	6-10 each side
Chicken Joints	1	15-20 each side
Chops - Lamb	1	7-10 each side
Pork	1	10-15 each side
Fish - Whole Trout/Mackerel	1	8-12 each side
Filletts - Plaice/Cod	1	4-6 each side
Kebabs	1	10-15 each side
Kidneys - Lamb/Pig	1	4-6 each side
Liver - Lamb/Pig	1	5-10 each side
Sausages	1	10-15 each side
Steaks - Rare	1	3-6 each side
Medium	1	6-8 each side
Well Done	1	7-10 each side
Toasted Sandwiches	1	1¼-1½ each side

Shelf positions are counted from the bottom upwards.

The times quoted above are given as a guide and should be adjusted to suit personal taste.

# THE FAN OVEN

## USES OF THE FAN OVEN

### PREHEATING

The fan oven quickly reaches its temperature, so it is not usually necessary to preheat the oven. Without preheating however, you may find you need to add an extra 5 - 10 minutes on the recommended cooking times. For recipes needing high temperatures, e.g. bread, pastries, scones, soufflés etc., best results are achieved if the oven is preheated first. For best results when cooking frozen or cooked chilled ready meals always preheat the oven first.

### COOKING TEMPERATURES

Fan oven cooking generally requires lower temperatures than conventional cooking. Follow the temperatures recommended in the chart on page 17. As a guide reduce temperatures by about 20°C - 25°C for your own recipes.

### BATCH BAKING

The fan oven cooks evenly on both shelf levels, especially useful when batch baking.

## SELECTING THE FAN OVEN

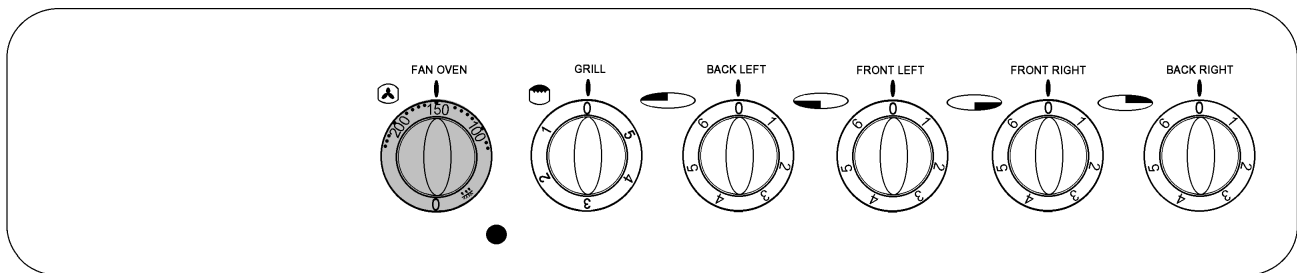

- Turn the fan oven temperature control to the required setting.

## THINGS TO NOTE

The main oven neon indicator will glow until the oven has reached the desired temperature and then go out. It will turn ON and OFF periodically during cooking showing that the temperature is being maintained.

## TO FIT THE OVEN SHELVES

The shelves should be fitted with the straight rods uppermost on the frame and the forms towards the back of the oven. If not fitted correctly the anti-tilt and safety stop mechanism will be affected.

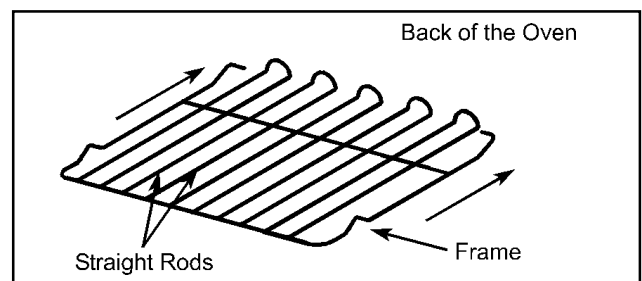

## HINTS AND TIPS

- Arrange the shelves in the required positions before switching the oven ON. Shelves are numbered from the bottom upwards.

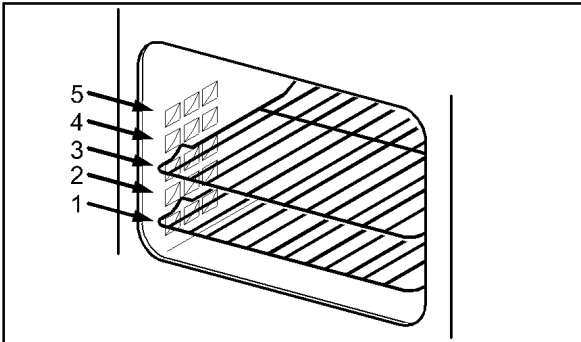

- When cooking more than one dish in the fan oven, place dishes centrally on different shelves rather than cluster several dishes on one shelf, this will allow the heat to circulate freely for the best cooking results.
- When batch baking one type of food e.g. Victoria sandwich cakes, those of similar size will be cooked in the same time.
- It is recommended that when baking larger quantities, the shelf positions should be evenly spaced to suit the load being cooked. A slight increase in cooking time may be necessary.

- DO NOT place baking trays directly on the oven floor as it interferes with the oven air circulation and can lead to base burning; use the lower shelf position. However, non-critical dishes/foods may be placed on the base of the oven when additional space is required.
- The use of excessively high temperatures can cause uneven browning. It may be necessary to reduce temperatures slightly. Refer to the recommendations given in the oven cooking chart on page 17.

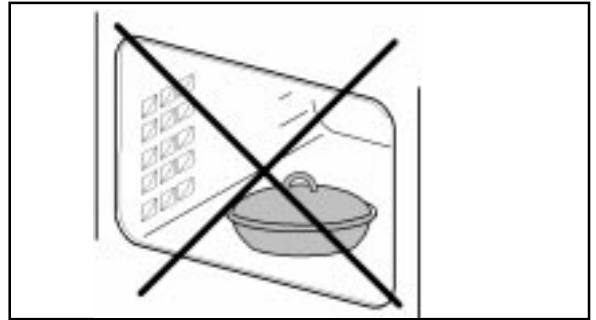



## FAN OVEN COOKING CHART

The oven temperatures are intended as a guide only. It may be necessary to increase or decrease the temperature by 10° C to suit individual preferences and requirements.

FOOD	FAN OVEN		
	SHELF POSITION	COOKING TEMP °C	APPROX. COOK TIME
Biscuits		180-190	10 - 20
Bread		200-220	25 - 30
Bread rolls/buns		200-220	15 - 20
Cakes:			
Small & Queen	Shelf	160-170	18 - 25
Sponges		160-170	18 - 20
Victoria Sandwich		160-170	18 - 25
Madeira	positions	140-150	1¼ - ½ h
Rich Fruit		130-140	2¼ - 2½ h
Christmas		130-140	3 - 4½ h
	are not		depends on size
Gingerbread		140-150	1¼ - 1½ h
Meringues		80-100	2½ - 3 h
Flapjack	critical	170-180	25 - 30
Shortbread		130-140	45 - 65
Casseroles:			
Beef/lamb		140-160	2½ - 3 h
Chicken	but ensure	180-190	1¼ - 1½ h
Convenience Foods		Follow manufacturers instructions	
Fish	that oven	170-190	20 - 30
Fish Pie (Potato Topped)		190-200	20 - 25
Fruit Pies and Crumbles		190-200	40 - 50
Milk Puddings	shelves are	130-140	1½ - 2 h
Pasta, Lasagne etc.		190-200	40 - 45
Pastry:			
Choux		190-200	30 - 35
Eclairs, Profiteroles	evenly	170-180	20 - 30
Flaky/Puff Pies		210-220	25 - 40
Shortcrust-Mince Pies		190-200	15 - 20
Meat Pies	spaced	190-210	25 - 35
Quiches, Tarts, Flans		180-210	25 - 45
Patés and Terrines		150-160	1 - 1½ h
Roasting Meat, Poultry	when more	160-180	see roasting chart
Scones		210-220	8 - 10
Shepherd's Pie		190-200	30 - 40
Soufflés		170-180	20 - 30
Vegetables:			
Baked Jacket Potatoes	than one is	180-190	1 - 1½h
Roast Potatoes		180-190	1 - 1½h
Stuffed Marrow		180-190	30 - 35
Stuffed Tomatoes	used	180-190	15 - 20
Yorkshire Puddings: Large		210-220	25 - 40
Individual		200-210	15 - 25

## ROASTING CHART

ROASTING CHART		
INTERNAL TEMPERATURES Rare : 50-60°C; Medium : 60-70°C; Well done : 70-80°C		
MEAT	FAN OVEN	COOKING TIME
Beef	160-180°C	20-35 minutes per ½kg (1lb) and 20-35 minutes over
Beef, boned	160-180°C	25-35 minutes per ½kg (1lb) and 25-35 minutes over
Mutton and Lamb	160-180°C	25-35 minutes per ½kg (1lb) and 25-35 minutes over
Pork and veal	160-180°C	30-40 minutes per ½kg (1lb) and 30-40 minutes over
Ham	160-180°C	30-40 minutes per ½kg (1lb) and 30-40 minutes over
Chicken	160-180°C	15-20 minutes per ½kg (1lb) and 20 minutes over
Turkey and goose	160-180°C	15-20 minutes per ½kg (1lb) up to 3½kg (7lb) then 10 minutes per ½kg (1lb) over 3½kg (7lb)
Duck	160-180°C	25-35 minutes per ½kg (1lb) and 25-35 minutes over
Pheasant	160-180°C	35-40 minutes per ½kg (1lb) and 35-40 minutes over
Rabbit	160-180°C	20 minutes per ½kg (1lb) and 20 minutes over
Potatoes with meat	160-180°C	according to size
Potatoes without meat	180-190°C	according to size

The roasting temperatures and times given in the chart should be adequate for most joints, but slight adjustments may be required to allow for personal requirements and the shape and texture of the meat. However, lower temperatures and longer cooking times are recommended for less tender cuts or larger joints.

Wrap joints in foil if preferred, for extra browning uncover for the last 30 - 60 min. cooking time.

## DEFROSTING

### USES OF DEFROST FEATURE

This fan oven function defrosts most foods faster than more conventional methods. It is particularly suitable for delicate frozen foods which are to be served cold e.g. cream filled gateaux, cakes covered with icings or frostings, cheesecakes, biscuits, scones etc.



It is preferable to thaw fish, meat and poultry slowly in the fridge. However, this process can be accelerated by using the defrost function.

### SELECTING DEFROST

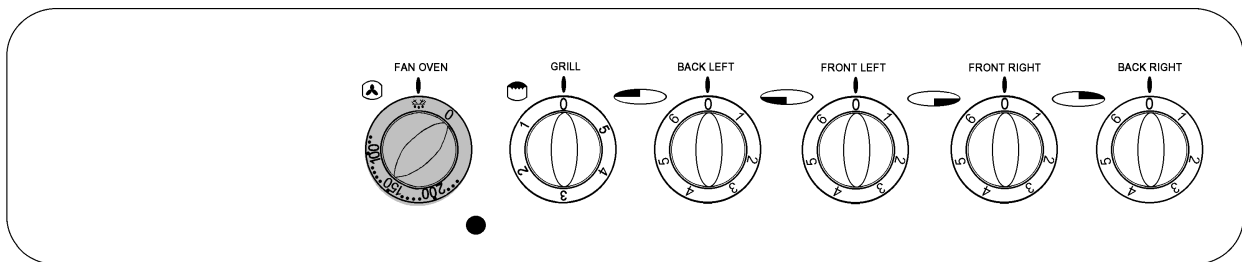

- Turn the fan oven temperature control to the defrost setting. 
- When defrost is selected, the oven indicator neon may come ON. It will stay ON until the oven reaches room temperature and then go OFF.
- It may turn ON and OFF periodically during defrosting to maintain steady room temperature inside the oven.

### THINGS TO NOTE

Care must always be taken when handling foods in the home. Always follow the basic rules of food hygiene to prevent bacterial growth and cross contamination when defrosting, preparing, cooking, cooling and freezing foods.

Small or thin fish fillets, frozen peeled prawns, cubed or minced meat, liver, thin chops, steaks etc., can be thawed in 1 - 2 hours.

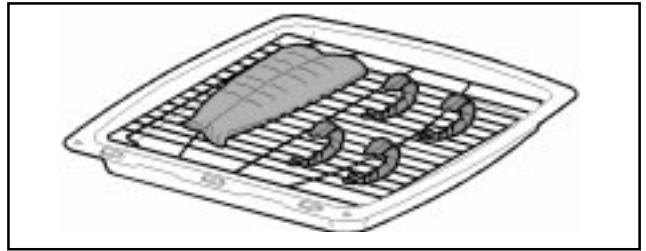

A 1kg/2¼lb oven ready chicken will be thawed in approximately 5 hours. Remove the giblets as soon as possible during the thawing process.

Joints of meat up to 2kg/4½lb in weight can be thawed using the defrost function.

**ALL JOINTS OF MEAT AND POULTRY MUST BE THAWED THOROUGHLY BEFORE COOKING.**

**ALWAYS COOK THOROUGHLY IMMEDIATELY AFTER THAWING.**

### HINTS AND TIPS

- Place the frozen food in a single layer where possible and turn it over half way through the defrosting process.

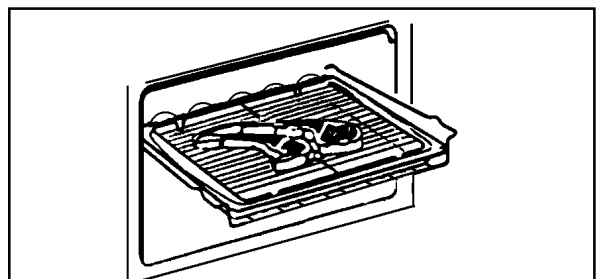

- The actual speed of defrosting is influenced by room temperature. On warm days defrosting will be faster than on cooler days.
- **DO NOT** leave food at room temperature once it is defrosted. Cook raw food immediately or store cooked food in the fridge.

## CARE AND CLEANING

**ALWAYS SWITCH OFF THE ELECTRICITY SUPPLY AT THE MAIN WALL SWITCH AND ALLOW THE COOKER TO COOL BEFORE CLEANING**

### CLEANING MATERIALS

Before using any cleaning materials on your cooker, check that they are suitable and that their use is recommended by the manufacturer.

Cleaners that contain bleach should NOT be used as they may dull the surface finishes. Harsh abrasives should also be avoided.

### CLEANING THE SEALED HOTPLATES AND HOTPLATE TRIMS

In order to maintain the appearance of your cooker's sealed hotplates and trims you are advised to use the recommended cleaning agents daily. If you do not allow spillages to burn on they will be much easier to clean off.

### THINGS TO NOTE

The red spot in the centre of the hotplates may be removed with some abrasive cleaning agents. This is not a fault and does not affect the performance of the hotplates.

### FOR NORMAL SOILAGE

Wipe over the hotplates and trims using a clean damp cloth then switch to a low or medium setting for a few minutes to thoroughly dry.

### FOR HEAVY SOILAGE

Use a clean damp cloth or scourer with a cream cleaner e.g. 'Jif' or a powder cleaner e.g. 'Ajax' on the hotplate and trims. Follow the circular grooved pattern on the hotplate when cleaning. Rinse off cleaning agents thoroughly. Dry as for normal soilage.

For more stubborn marks warm the hotplate on a low setting for 30 seconds. Clean the sealed plate with 'Ajax' powder cleaner, 'Jif' cream cleaner or a 'Brillo' pad. You may have to rub hard for several minutes.

Rinse off cleaning agents thoroughly with a damp cloth. Switch to a low or medium setting for a few minutes until the hotplate is thoroughly dry.

### CLEANING THE HOTPLATE TRIMS

The stainless steel trims may become straw coloured during use. Using a proprietary stainless steel cleaner, e.g. 'Shiny Sinks' will help maintain a bright appearance. Alternatively a powder cleaner such as 'Bar Keepers Friend' may be used regularly.

### CLEANING THE VITREOUS ENAMEL

Use a clean damp cloth or scourer made for non-stick saucepans with 'Jif' cream cleaner.

### AFTER CLEANING

To maintain the appearance of the hotplates occasionally apply a little salt free vegetable oil or commercial restorative agent.

To apply vegetable oil, first heat the hotplate on a medium setting for 30 seconds then turn OFF. Pour a very small amount of oil onto kitchen paper, apply the paper to the hotplate and wipe off any excess oil. Heat the hotplate on a medium setting for 1 minute.

To apply restorative agent, apply a thin coating of '4 Hob' or use a 'Minky' Hotplate Cleaning Cloth following the manufacturers instructions.

### CLEANING THE OUTSIDE OF THE COOKER

DO NOT use abrasive cleaning materials eg Hob Brite, Brillo pads or scourers on the painted or printed finishes as damage may occur. Regularly wipe over the control panel, oven doors and cooker sides using a soft cloth and liquid detergent.

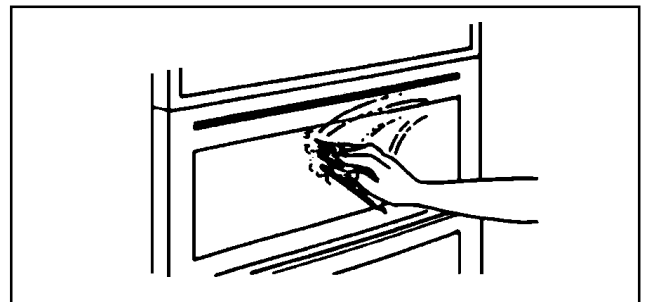

DO NOT ATTEMPT TO REMOVE ANY OF THE CONTROL KNOBS FROM THE PANEL AS THIS MAY CAUSE DAMAGE AND IS A SAFETY HAZARD.

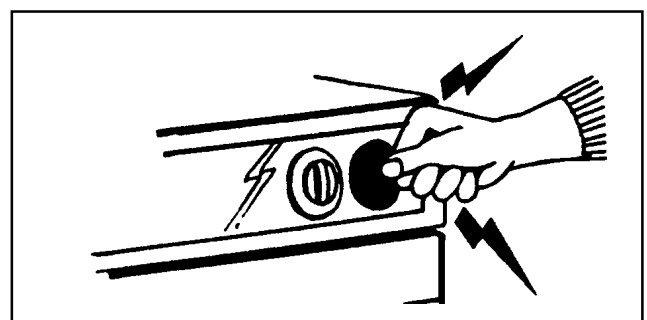

## CLEANING THE GRILL PAN, GRILL PAN GRID AND OVEN SHELVES

All removable parts, except the grill pan handle can be washed in the dishwasher.

The grill pan may be cleaned using a soap impregnated steel wool pad. The grill pan grid and oven shelves should be cleaned using hot soapy water. Soaking first in soapy water will make cleaning easier.

## CLEANING INSIDE THE OVEN AND GRILL COMPARTMENTS

The Stayclean surface on the rear oven panel should not be cleaned manually.

The vitreous enamel base and sides in the grill compartment and the fan oven base and sides can be cleaned using normal oven cleaners or aerosol oven cleaners with care. Ensure that the manufacturers instructions are followed and that all parts are well rinsed afterwards.

**Aerosol cleaners must not be used on the Stayclean rear oven panel and must not come into contact with elements or the door seal as this may cause damage.**

See Hints and Tips for keeping oven soilage to a minimum.

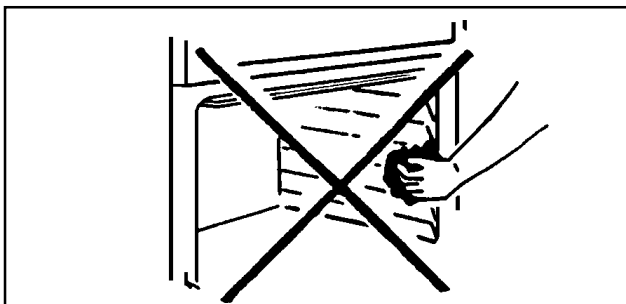

## HINTS AND TIPS

- Manual cleaning of the Stayclean surface IS NOT recommended. Damage will occur if oven sprays or abrasives of any kind are used.
- The Stayclean surface destroys splashes of food and fats when the oven temperature is raised to around 220°C.
- It is a good idea to run the oven for an hour or two per week to ensure continued good performance from the Stayclean finish.
- Slight discolouration and polishing of the Stayclean surface may occur in time. This DOES NOT affect the Stayclean properties in any way.
- Follow the recommendations below to keep oven soilage to a minimum.
- Cook at the recommended temperatures. Higher temperatures during roasting will increase soilage. Try cooking at lower temperatures for an increased length of time, you will save energy and often the joint is more tender.
- Use minimal, if any, extra oil or fat when roasting meat, potatoes only require brushing with fat before cooking. Extra fat in the oven during roasting will increase splashing and soilage.
- It is NOT necessary to add water to the meat tin when roasting. The water and the fat juices from the joint create excessive splattering during cooking - even at normal temperatures, as well as causing condensation.
- Covering joints during cooking will also prevent splashing onto the interior surfaces. Removing the covering for the last 20-30 minutes will allow extra browning if required. Some large joints and turkeys especially benefit by this method of cooking, allowing the joint to cook through before the outside is overbrowned.

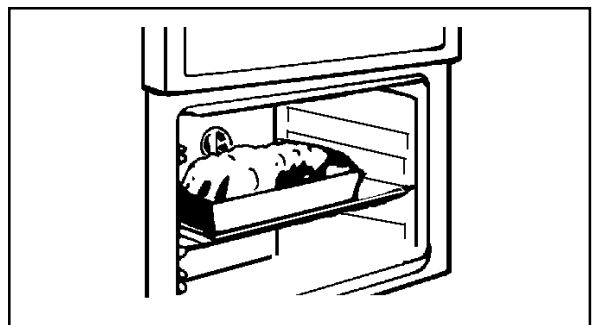

## SOMETHING NOT WORKING?

We strongly recommend that you carry out the following checks on your cooker before calling a Service Engineer. It may be that the problem is a simple one which you can solve yourself without the expense of a service call.

If our Service Engineer finds that the problem is listed below you will be charged for the call whether or not the cooker is under guarantee.

### **The cooker does not work at all:**

- \* Check that the cooker has been wired in and is switched on at the wall.
- \* Check that the main cooker fuse is working.

### **The hotplates and oven work but the grill does not:**

- \* Check that you have carefully followed the instructions for the operation of the grill.

### **The grill does not work:**

- \* Check that the grill door is left open during grilling.

### **The oven temperature is too high or low:**

- \* Check that the recommended temperatures are being used (see page 17). Be prepared to adjust up or down by 10°C to achieve the results you want.
- \* Care should be taken when using an oven thermometer to check oven temperatures as they may be inaccurate.

The following factors should be considered.

- \* Ensure you purchase an accurate good quality instrument.
- \* The oven will cycle about a set temperature and will not be constant.

### **If the oven is not cooking evenly or the side opening door will not stay open:**

- \* Check that the cooker is level.
- \* Check that the recommended temperatures and shelf positions are being used.

### **The fan oven is noisy:**

- \* Check that the oven is level.
- \* Check that bakeware and shelves are not vibrating in contact with the back panel in the oven.

# SERVICE AND SPARE PARTS



In the event of your appliance requiring service, or if you wish to purchase spare parts please contact your local Tricity Bendix Service Force Centre by telephoning:

**0870 5 929929**

Your call will be routed to the Service Force Centre covering your post code area. The address of your local Service Force Centre is detailed on pages 24 - 25.

For Service in the **Republic of Ireland** contact  
Tricity Bendix  
Long Mile Road  
Dublin 12

Telephone: 01 4090752

Before calling out an engineer, please ensure you have read the details under the heading 'Something Not Working'.

When you contact the Service Centre you will need to give the following details:

1. Your name, address and post code
2. Your telephone number
3. Clear and concise details of the fault
4. The model, product and serial number of the appliance (found on the rating plate)
5. The purchase date

## CUSTOMER CARE DEPARTMENT

For general enquiries concerning your Tricity Bendix appliance, or further information on Tricity Bendix products, you are invited to contact our Customer Care Department by letter or telephone as follows:

Customer Care Department  
Tricity Bendix  
55 - 77 High Street  
Slough  
Berkshire  
SL1 1DZ

Tel: 0870 5 950950 \*

( \*call to this number may be recorded for training purposes.)

To contact your local Tricity Bendix Service Centre telephone **0870 5 929929**

**CHANNEL ISLANDS**

GUERNSEY	Guernsey Electricity PO Box 4 Vale, Guernsey Channel Islands
JERSEY	Jersey Electricity Company PO Box 45 Queens Road St Helier Jersey Channel Islands JE4 8NY

**SCOTLAND**

ABERDEEN (M05)	54 Claremont Street Aberdeen AB10 6RA
AUCHTERMUCHY (M03)	33A Burnside Auchtermuchy Fife KY14 7AJ
BLANTYRE (M07)	Unit 5 Block 2 Auchenraith Ind Estate Rosendale Way Blantyre G72 0NJ
DUMFRIES (M01)	93 Irish Street Dumfries Scotland DG1 2PQ
DUNOON (M67)	Briar Hill 7 Hill Street, Dunoon Argyll PA23 7AL
GLASGOW (M04)	20 Cunningham Road Clyde Estate Rutherglen, Glasgow, G73 1PP
INVERNESS (M06)	Unit 3B Smithton Ind. Estate Smithton Inverness IV1 AJ
ISLE OF ARRAN  (OWN SALES)	Arran Domestics Unit 4 The Douglas Centre Brodict Isle of Arran KA27 8AJ
ISLE OF BARRA  (OWN SALES)	J Zerfah 244 Bruernish Isle of Barra Western Islands HS9 5QY
ISLE OF BUTE (M66)	Walker Engineering Glenmhor Upper Serpentine Road Rothsay Isle of Bute PA20 9EH
ISLE OF LEWIS (M69)	ND Macleod 16 James Street Stornoway Isle of Lewis PA87 2QW
KELSO (M08)	2-8 Wood Market Kelso Borders TD5 7AX

ORKNEY (M65)	Corsie Domestics 7 King Street Kirkwall Orkney KW15
PERTH	Hydro Electric Inveralmond House Ruthvenfield Road Perth PH1 3AQ
PERTH	Graham Begg Unit 4 Airport Ind Estate Wick KW1 4QS
(OWN SALES)	
SHETLAND	Tait Electronic Systems Ltd. Holmsgarth Road Lerwick Shetland ZE1 0PW
(OWN SALES)	
SHETLAND	BoIts Shetland Ltd 26 North Road Lerwick Shetland ZE1 0PE
(OWN SALES)	
WHALSAY	Leask Electrical Harlsdale Symbister, Whalsay Shetland ZE2 9AA
(OWN SALES)	

**NORTHERN IRELAND**

BELFAST (M27)	Owenmore House Kilwee Business Park Upper Dunmury Lane Belfast BT17 0HD
------------------	---

**WALES**

CARDIFF (M28)	Guardia Industrial Estate Clydesmuir Road Tremorfa, Cardiff CF2 2QS
CLYWD (M14)	Unit 6-7 Coed - Parc Abergele Road Rhuddlan Clwyd Wales LL18 5UG
DYFED (M77)	Maes Y Coed High Mead Llanybydder Camarthenshire SA40 9UL
HAVERFORDWEST (M75)	Cromlech Lodge Ambleton Haverfordwest Pembrokeshire SA62 5DS
OSWESTRY (M17)	Plas Ffynnon Warehouse Middleton Road Oswestry SY11 2PP

**NORTH EAST**

GATESHEAD (M39)	Unit 356a Dukesway Court Dukesway Team Valley Gateshead NE11 0BH
GRIMSBY (M42)	15 Hainton Avenue Grimsby South Humberside DN32 9AS
HULL (M41)	Unit 1 Boulevard Industrial Estate Hull HU3 4AY
LEEDS (M37)	64-66 Cross Gates Road Leeds LS15 7NN
NEWTON AYCLIFFE (M45)	Unit 16 Gurney Way Aycliffe Industrial Estate Newton Aycliffe DL5 6UJ
SHEFFIELD (M38)	Pennine House Roman Ridge Ind. Roman Ridge Road Sheffield S9 1GB

**NORTH WEST**

BIRKENHEAD (M11)	1 Kelvin Park Dock Road Birkenhead L41 1LT
CARLISLE (M10)	Unit 7 James Street Workshops James Street Carlisle Cumbria CA2 5AH
ISLE OF MAN (M64)	South Quay Ind. Estate Douglas Isle of Man IM1 5AT
LIVERPOOL (M15)	Unit 1 Honeys Green Precinct Honeys Green Lane Liverpool L12 9JH
MANCHESTER (M09)	Unit B Central Industrial Estate St Marks Street Bolton BL3 6NR
PRESTON (M13)	Unit 250 Dawson Place Walton Summit Bamber Bridge Preston Lancashire PR5 8AL
STOCKPORT (M16)	Unit 20 Haigh Park Haigh Avenue Stockport SK4 1QR



**MIDLANDS**

<b>BIRMINGHAM (M18)</b>	66 Birch Road East, Wyrley Road Ind. Estate Witton Birmingham B6 7DB
<b>BOURNE (M44)</b>	Manning Road Ind Estate Pinfold Road Bourne PE10 9HT
<b>BRIDGNORTH (M72)</b>	68 St. Mary's Street Bridgnorth Stropshire WV16 4BB
<b>GLOUCESTER (M23)</b>	101 Rycroft Street Gloucester GL1 4NB
<b>HEREFORD (M31)</b>	Unit 3 Bank Buildings Cattle Market Hereford HE4 9HX
<b>HIGHAM FERRERS (M51)</b>	30 High Street Higham Ferrers Northants NN10 8BB
<b>ILKESTON (M43)</b>	Unit 2 Furnace Road Ilkeston DE7 5EP
<b>LEICESTER (M22)</b>	Unit 7 Oaks Industrial Estate Coventry Road Narborough Leicestershire LE0 5GF
<b>LINCOLN (M40)</b>	Unit 8 Stonefield Park Clifton Street Lincoln LN5 8AA
<b>NEWCASTLE UNDER LYME (M12)</b>	18-21 Croft Road Brampton Ind. Estate Newcastle under Lyme Staffordshire ST5 0TW
<b>REDDITCH (M20)</b>	13 Thornhill Road North Moons Moat Redditch Worcestershire B98 9ND
<b>TAMWORTH (M19)</b>	Unit 3 Sterling Park Claymore Tamworth B77 5DO
<b>WORCESTER (M73)</b>	Unit 1&2 Northbrook Close Gregorys Mill Ind Estate Worcester WR3 8BP

**LONDON & EAST ANGLIA**

<b>BECKENHAM (M79)</b>	11a Gardener Industrial Estate Kent House Lane Beckenham Kent BR3 1QZ
<b>CHELMSFORD (M47)</b>	Hanbury Road Widford Ind Estate Chelmsford Essex CM12 3AE
<b>COLINDALE (M53)</b>	Unit 14 Capitol Park Capitol Way Colindale London NW9 0EQ
<b>ELTHAM (M78)</b>	194 Court Road Mottingham Eltham London SE9 4EW
<b>ENFIELD (M49)</b>	284 Alma Road Enfield London EN3 7BB
<b>GRAVESEND (M57)</b>	Unit B4, Imperial Business Estate Gravesend Kent DA11 0DL
<b>HARPENDEN (M46)</b>	Unit 4 Riverside Estate Coldharbour Lane Harpenden AL5 4UN
<b>LETCHEWORTH (M50)</b>	16-17 Woodside Ind Est. Works Road Letchworth Herts SG6 1LA
<b>LONDON (M76)</b>	2/4 Royal Lane Yiewsley West Drayton Middlesex UB7 8DL
<b>MAIDENHEAD (M60)</b>	Reform Road Maidenhead Berkshire SL6 8BY
<b>MOLESEY (M61)</b>	10 Island Farm Avenue West Molesey Surrey KT8 2UZ
<b>NEWBURY (M24)</b>	9 Pipers Court Berkshire Drive Thatcham Berkshire RG19 5GF
<b>IPSWICH (M48)</b>	Unit 6C EltonParkBusiness Centre Hadleigh Road Ipswich IP2 0DD
<b>NORWICH (M52)</b>	2b Trafalgar Street Norwich NR1 3HN
<b>SUNBURY (M63)</b>	Unit 1a The Summit Hanworth Road Hanworth Ind Estate Sunbury on Thames TW16 5D

**SOUTH EAST**

<b>ASHFORD (M58)</b>	Unit 2 BridgeRoadBusiness Est Bridge Road Ashford Kent TN2 1BB
<b>FLEET (M59)</b>	Unit 1 Redfields Ind Estate Church Crookham Fleet Hampshire GU13 0RD
<b>HAYWARDS HEATH (M55)</b>	21-25 Bridge Road Haywards Heath Sussex RH16 1UA

**SOUTH WEST**

<b>BARNSTAPLE (M30)</b>	Main Road Fremington Barnstaple North Devon EX31 2NT
<b>BOURNEMOUTH (M26)</b>	63-65 Curzon Road Bournemouth Dorset BH1 4PW
<b>BRIDGEWATER (M35)</b>	6 Hamp Ind.Estate Bridgewater Somerset TA6 3NT
<b>BRISTOL (M25)</b>	11 Eldon Way Eldonwall Trading Bristol Avon BS4 3QQ
<b>EMSWORTH (M33)</b>	266 Main Road Southbourne Emsworth PO10 8JL
<b>ISLE OF WIGHT (M34)</b>	Unit 8 Enterprise Court Ryde Business Park Ryde Isle of Wight PO33 1DB
<b>NEWTON ABBOT (M29)</b>	Unit 2 Zeally Ind. Estate Kingsteignton Newton Abbot S. Devon TQ12 3TD
<b>REDRUTH (M36)</b>	Unit 7D Pool Ind. Estate Wilson Way, Redruth, Cornwall TR15 3QW

## GUARANTEE CONDITIONS

### Standard guarantee conditions

We, Tricity Bendix, undertake that if within 12 months of the date of the purchase this Tricity Bendix appliance or any part thereof is proved to be defective by reason only of faulty workmanship or materials, we will, at our option repair or replace the same FREE OF CHARGE for labour, materials or carriage on condition that:

- The appliance has been correctly installed and used only on the electricity supply stated on the rating plate.
- The appliance has been used for normal domestic purposes only, and in accordance with the manufacturer's instructions.
- The appliance has not been serviced, maintained, repaired, taken apart or tampered with by any person not authorised by us.
- All service work under this guarantee must be undertaken by a Tricity Bendix service centre.
- Any appliance or defective part replaced shall become the Company's property.
- This guarantee is in addition to your statutory and other legal rights.

Home visits are made between **8.30am** and **5.30pm** Monday to Friday. Visits may be available outside these hours in which case a **premium** will be charged.

### Exclusions

**This guarantee does not cover:**

- Damage or calls resulting from transportation, improper use or neglect, the replacement of any light bulbs or removable parts of glass or plastic.
- Costs incurred for calls to put right an appliance which is improperly installed or calls to appliances outside the United Kingdom.
- Appliances found to be in use within a commercial environment, plus those which are subject to rental agreements.
- Products of Tricity Bendix manufacture which are not marketed by Tricity Bendix.

### European Guarantee

If you should move to another country within Europe then your guarantee moves with you to your new home subject to the following qualifications:

- The guarantee starts from the date you first purchased your product.
- The guarantee is for the same period and to the same extent for labour and parts as exists in the new country of use for this brand or range of products.
- This guarantee relates to you and cannot be transferred to another user.
- Your new home is within the European Community (EC) or European Free Trade Area.
- The product is installed and used in accordance with our instructions and is only used domestically, i.e. a normal household.
- The product is installed taking into account regulations in your new country.

Before you move please contact your nearest Customer Care centre, listed below, to give them details of your new home. They will then ensure that the local Service Organisation is aware of your move and able to look after you and your appliances.

France	Senlis	+33 (0)3 44 62 28 28
Germany	Nürnberg	+49 (0)911 323 2600
Italy	Pordenone	+39 (0)1678 47053
Sweden	Stockholm	+46 (0)20 78 77 50
UK	Slough	+44 (0)1753 219898



## RATING PLATE REFERENCE

MAKE AND MODEL NO.	PRODUCT NO.	SERIAL NO.	DATE OF PURCHASE

### IMPORTANT NOTICE

In line with our continuing policy of research and development, we reserve the right to alter models and specifications without prior notice.

This handbook is accurate at the date of printing, but will be superseded and should be disregarded if specifications or appearance are changed.



TRICITY BENDIX, 55 - 77 HIGH STREET, SLOUGH, BERKSHIRE, SL1 1DZ  
TELEPHONE 0870 5 950950

MODEL NO.  
**RE50M**



PART NO.  
**311528602**

© Electrolux Household Appliances Limited 2000

 **From the Electrolux Group.** *The world's No. 1 choice.*

The Electrolux Group is the world's largest producer of powered appliances for kitchen, cleaning and outdoor use. More than 55 million Electrolux group products (such as refrigerators, cookers, washing machines, vacuum cleaners, chain saws and lawn mowers) are sold each year to a value of approx. USD 14 billion in more than 150 countries around the world.

Download from [www.Somanuals.com](http://www.Somanuals.com). All Manuals Search And Download.

## Free Manuals Download Website

<http://myh66.com>

<http://usermanuals.us>

<http://www.somanuals.com>

<http://www.4manuals.cc>

<http://www.manual-lib.com>

<http://www.404manual.com>

<http://www.luxmanual.com>

<http://aubethermostatmanual.com>

Golf course search by state

<http://golfingnear.com>

Email search by domain

<http://emailbydomain.com>

Auto manuals search

<http://auto.somanuals.com>

TV manuals search

<http://tv.somanuals.com>