

TRICITY BENDIX

Better Products. Better Value.



OPERATING AND INSTALLATION INSTRUCTIONS

MODEL NO.
SI 255

TECHNICAL DETAILS

MODEL NO. SI 255

Voltage: 230/240 Volts AC 50Hz

Wattage: 8.6/9.3 kW

Height: 900mm

Width: 550mm

Depth: 600mm

This appliance carries the C.E. mark.

This appliance complies with European Council Directive 72/23/EEC.

CONTENTS

Technical Details	2
Contents	3
Preface	5
Safety	6
Before Installation	6
During Operation	6
After Use	7
General	7
Introduction	8
Rating Plate	8
Installation	8
Reversible Oven Door	9
General Notes on Using Your Cooker	9
About Condensation and Steam	9
Oven/Hot Hob Indicator Neons	9
Grill and Oven Furniture	9
Getting to Know Your Cooker	10
The Control Panel	10
The Electronic Minute Minder	11
The Ceramic Hob	13
Recommended Saucepans	13
Things To Note	13
Hints and Tips	13
Hot Hob Indicator	14
Deep Fat Frying	14
Preserving	15
The Grill	16
Selecting the Grill	16
Things to Note	16
The Grill Pan and Handle	16
Hints and Tips	17
Grilling Chart	17
The Oven	18
Selecting the Oven	18
Things to Note	18
To Fit the Oven Shelves	18
Hints and Tips	18
Oven Cooking Chart	19
Roasting Chart	20

CONTENTS

Care and Cleaning	21
Cleaning Materials	21
Cleaning the Ceramic Hob	21
Hints and Tips	22
Cleaning the Outside of the Cooker	22
Cleaning the Grill Pan, Grill Pan Grid, Meat Tin and Oven Shelves	22
Cleaning Inside the Grill/Oven Compartments	22
Care of Stayclean Surfaces	23
Hints and Tips	23
Something not Working?	24
Service and Spare Parts	25
Customer Service Centres	26
Guarantee Conditions	30

PREFACE

Dear Customer,

Thank you for buying a Tricity Bendix cooker. With our 80 years experience in developing and manufacturing the very best in U.K. cookers, you can be assured that you have purchased a hard working, reliable, quality product.

Tricity Bendix cookers comply with British Standard safety and performance requirements. They have been approved by BEAB (British Electrotechnical Approvals Board) and are covered by a 12 month parts and labour guarantee.

To get the best from your new Tricity Bendix cooker, we ask that you PLEASE READ THESE INSTRUCTIONS CAREFULLY. Particular attention should be made to cooking times and temperatures which may differ from your previous cooker.

It is most important that this instruction book is retained with the appliance for future reference. Should the appliance be sold, or if you move house and leave the appliance, always ensure that the book remains with the appliance. This will enable the new owner to be acquainted with the functioning of the appliance and the relevant warnings.

Please read the whole instruction book before attempting to use the appliance ensuring you follow the recommendations given.

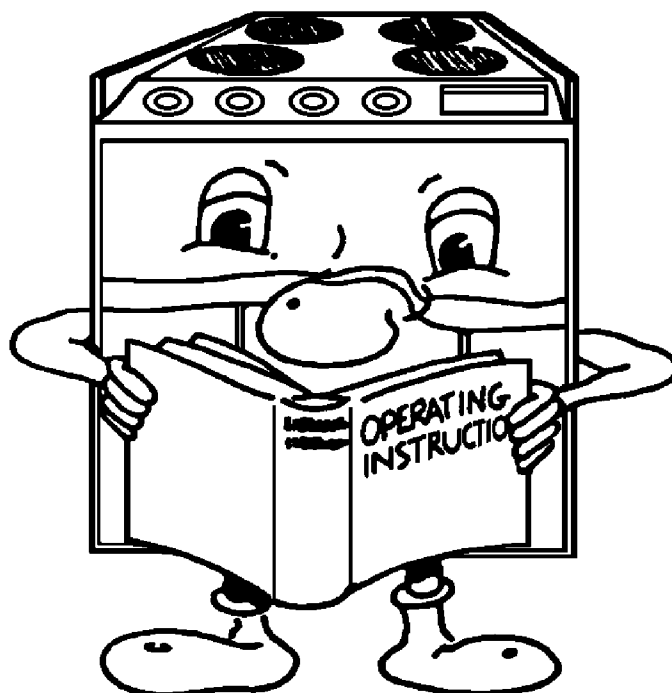

SAFETY

THESE WARNINGS ARE PROVIDED IN THE INTERESTS OF YOUR SAFETY. ENSURE THAT YOU UNDERSTAND THEM ALL BEFORE INSTALLING OR USING THE COOKER.

PLEASE
READ
CAREFULLY

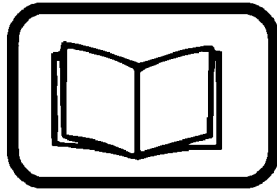

BEFORE INSTALLATION



This appliance is heavy and care **must** be taken when moving it.



Ensure that all packaging, both inside and outside the appliance, has been removed before the appliance is used.



Do not try to move the appliance by pulling the door handles.

The electrical installation work **must** be undertaken by a qualified electrician/competent person.



It is dangerous to alter or modify the specifications of the product in any way.

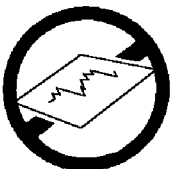

Do not use the appliance if the ceramic glass is damaged. If a fault or crack becomes visible during cooking disconnect the appliance immediately from the electricity supply and contact the Customer Service Centre.



After installation, please dispose of the packaging with due regard to safety and the environment.

DURING OPERATION



Do not use this appliance if it is in contact with water. **Never** operate it with wet hands.



This appliance is designed to be operated by adults and children under supervision. Young children **must not** be allowed to tamper with the product or play with the controls.

Accessible parts especially around the grill area may become hot when the appliance is in use. Children should be **kept away** until it has cooled.

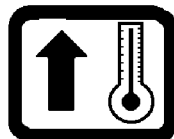

Take **great care** when heating fats and oils as they will ignite if they become too hot.

This product has been designed for cooking edible foodstuffs only, and **must not** be used for any other purposes.



Never place plastic or any other material which may melt in the oven or on the hob.



Ensure cooking utensils are large enough to contain foods to prevent spillages and boil overs.

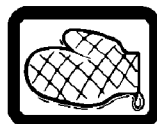

The handles of saucepans which are smaller than the heated area on the hob will become hot. **Ensure** your hand is protected before handling the pan.



Take care to follow the recommendations given for tending the food when grilling.



Do not leave the handle in position when grilling as it will become hot.

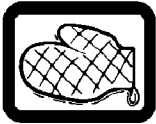

Always use oven gloves to remove and replace food in the oven. Similarly always use oven gloves to remove and replace the grill pan handle when grilling. Recommendations given on page 16.



Ensure that you support the grill pan when it is in the withdrawn or partially withdrawn position.

Ensure that all vents are left unobstructed to ensure ventilation of the oven cavity.

Ensure that the anti-tilt shelves are put in place correctly. Refer to instructions on page 18.

Never line any part of the appliance with aluminium foil.



Always stand back from the appliance when opening the oven door to allow any build up of steam or heat to release.



Do not place sealed cans or aerosols inside the oven. They may explode if they are heated.

Do not leave the hotplates switched on for long periods when not covered by a saucepan. The controls may overheat.

AFTER USE



Ensure that all control knobs are in the OFF position when not in use.

For hygiene and safety reasons this appliance should be kept clean at all times. A build-up of fats or other foodstuffs could result in a fire, especially in the grill pan.



Do not leave utensils containing foodstuffs, e.g. fat or oil in or on the appliance in case it is inadvertently switched ON.

Cookers and hobs become **very hot**, and retain their heat for a long period of time after use. Children should be kept well away from the appliance until it has cooled.

GENERAL



Under no circumstances should repairs be carried out by inexperienced persons as this may cause injury or serious malfunction. This product should be serviced by an authorised Service Engineer and only genuine approved spare parts should be used. Details of servicing and repair arrangements are given on page 25 of this book.



Do not stand on the appliance or on the open oven door.



Do not hang towels, dishcloths or clothes from the appliance or its handles. They are a safety hazard.



Only clean this appliance in accordance with the instructions given in this book.

Your safety is of paramount importance.

Therefore, if you are unsure about any of the meanings of these WARNINGS contact the:

Consumer Care Department
Telephone (01582) 585858

INTRODUCTION

WARNING: THIS APPLIANCE MUST BE EARTHED

RATING PLATE

Record the model and serial numbers on the back cover of this instruction book, from the rating plate. This is situated on the lower front frame of the appliance and can be seen upon opening the oven door.

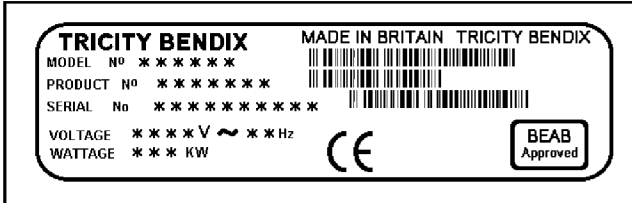

The appliance must be protected by a suitably rated fuse or circuit breaker. The rating of the appliance is given on the rating plate.

INSTALLATION

This appliance complies with Radio Interference requirements of EEC Directive 87/308/EEC.

If your cooker has been damaged in transit, contact your supplier immediately. **DO NOT** attempt to install it.

Your cooker left the factory fully packaged to protect it from damage. If it is delivered without packaging and damage has occurred, the manufacturer cannot accept responsibility. Contact your supplier for advice.

Once the packaging has been removed the cooker should only be moved by hand. **DO NOT** use a sack barrow or any other aid to lift the cooker as damage may occur.

Connection to the electricity supply must be carried out by a qualified electrician/competent person.

The electrical connection should be made using a double pole isolating switch (cooker socket) with at least 3mm contact separation. The cable must have conductors of sufficiently high cross-sectional area to prevent overheating and deterioration.

Six square millimetres (6.00mm²) is the recommended cross-section area.

The cable should be routed away from potentially hot areas marked by X in the diagram below.

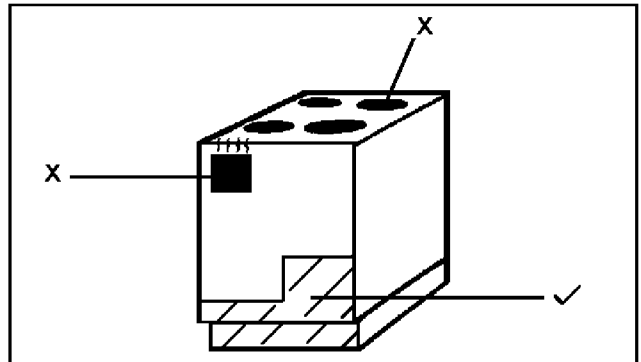

To move the cooker, open the oven door and lift the cooker by holding inside the top of the compartment.

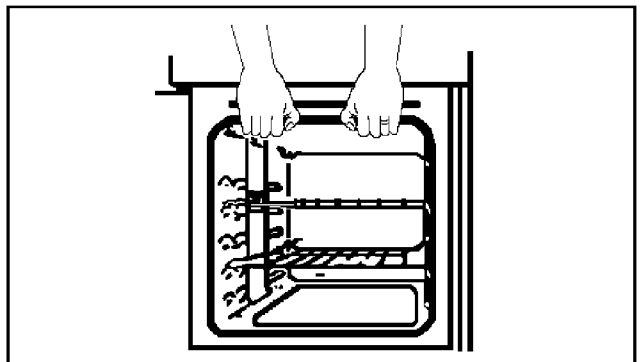

This is a type Y appliance which means it is free-standing and can be fitted with cabinets on one or both sides. It may also be fitted in a corner setting.

Side walls which are above hob level should be protected by heat resistant non-combustible material and **MUST NOT** be nearer than 40mm to the hob side.

A nominal air gap of 2mm all around the cooker is required to enable the cooker to be moved into position.

A spacer has been incorporated into the back of the appliance to ensure an air gap of 10mm is maintained at hotplate level. Tiles or other forms of deep wall covering should not obscure this gap.

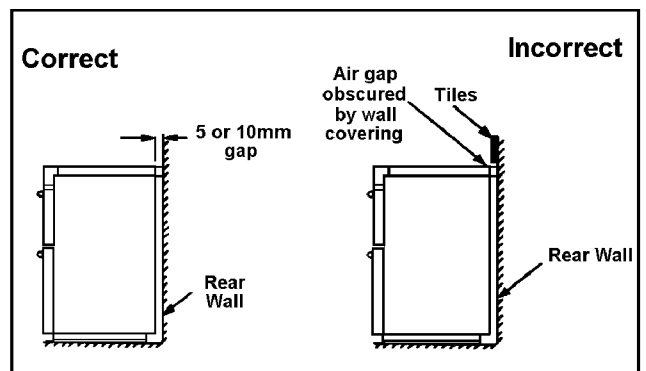

Overhanging surfaces or a cooker hood should be a minimum of 685mm above the hob.

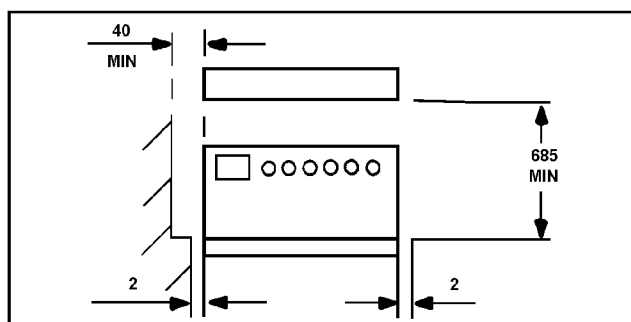

It is important to ensure that the appliance is level after installation. Levelling feet are fitted to the front of the appliance to accommodate uneven floors.

REVERSIBLE OVEN DOOR

If you require the oven door to be hinged on the opposite side, you will need to contact a qualified Service Engineer. See page 26 for your nearest Service Centre. PLEASE NOTE that a charge will be made.

GENERAL NOTES ON USING YOUR COOKER

We suggest that you run all the elements for a short period to burn off any residue from their surfaces.

During this period an unpleasant odour may be emitted, it is therefore advisable to open a window for ventilation.

ABOUT CONDENSATION AND STEAM

When food is heated it produces steam similar to a boiling kettle. The oven is vented to allow some of this steam to escape. However, always stand back from the appliance when opening the oven door to allow any build up of steam or heat to release.

If the steam comes into contact with a cool surface on the outside of the appliance, e.g. a trim, it will condense and produce water droplets. This is quite normal and is not caused by a fault on the appliance.

To prevent discolouration, regularly wipe away condensation and also soilage from surfaces.

For your safety, wall coverings at the rear of the appliance should be securely fixed to the wall.

OVEN / HOT HOB INDICATOR NEONS

These lights indicate whether the oven or hob are switched on. In the case of the oven, the neon also indicates when the set temperature has been reached. The neon will cycle on and off during use to show that the temperature is being maintained. The hot hob neon will come on when any of the hotplate controls are turned and will remain on until the hob has cooled.

GRILL AND OVEN FURNITURE

The following items of oven furniture have been supplied with the cooker:

1 grill pan



1 grill pan handle



1 grill pan grid

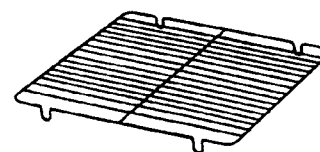

1 meat tin



1 trivet



1 cranked shelf for grilling only



2 straight shelves for oven cooking

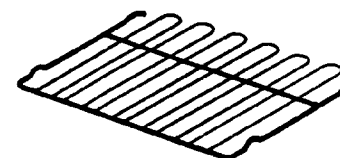

Scuffing of the Stayclean oven linings by the oven furniture pack may occur during transit. These marks will disappear after the oven elements have been burnt off for the first time.

GETTING TO KNOW YOUR COOKER

THE CONTROL PANEL

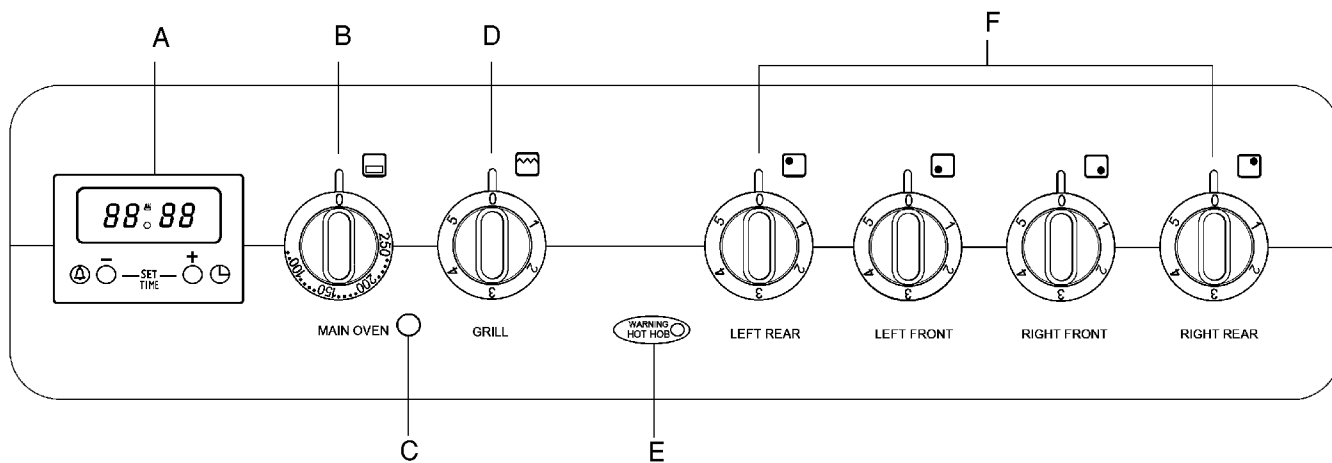

FEATURES

- A - Electronic Minute Minder
- B - Oven Control
- C - Oven Indicator Neon
- D - Grill Control
- E - Hot Hob Indicator Neon
- F - Hotplate Controls

ELECTRONIC MINUTE MINDER

- 1 = (-) DECREASE CONTROL & MINUTE MINDER SETTING BUTTON
- 2 = (+) INCREASE CONTROL
- (👁️) COOKING SYMBOL
- (🕒) CLOCK SETTING CONTROL
- (🔔) MINUTE MINDER SYMBOL

The electronic minute minder can indicate the time of day, operate as a minute minder and it can be used to time and switch off the oven.

1. SET THE TIME OF DAY

When the electricity supply is first switched ON, the display will flash both 88.88 and (👁️). See Fig. 1.

Press buttons (1) and (2) together. The display will read 12:00. See Fig. 2.

Within five seconds press and hold either button (1) to decrease or button (2) to increase the time until the correct time of day on the 24 hour clock is reached, e.g. 14:30. The cooking symbol (👁️) will go out. See Fig. 3.

Note: The increase and decrease control buttons operate slowly at first, and then more rapidly. They should be pressed separately.

2. THE MINUTE MINDER

IMPORTANT

The minute minder can be used to time a set cooking period. At the end of the cook time the minute minder will automatically switch off the oven if in use.

The minute minder gives an audible reminder at the end of any period of cooking up to 23 hours and 59 minutes.

To set press button (1) and the display will read 00:00, see Fig. 4.

Release button (1) and press and hold button (2). The display will count up in one minute intervals until the interval to be timed is reached e.g. 30 minutes, see Fig. 5. If necessary press and hold button (1) to achieve the correct time interval.

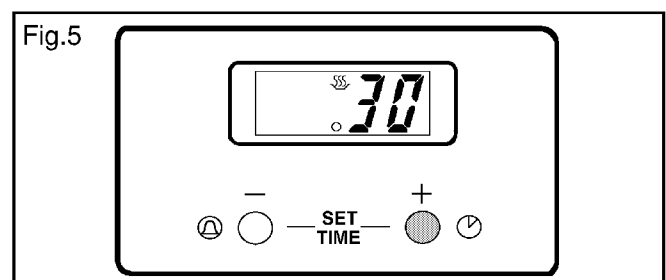
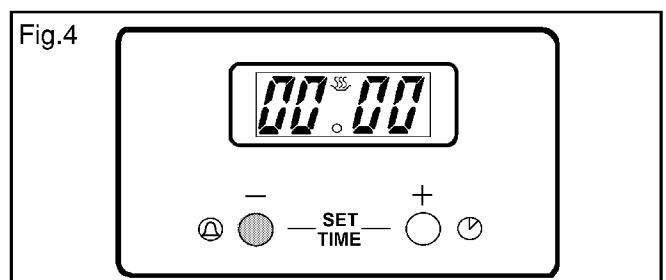
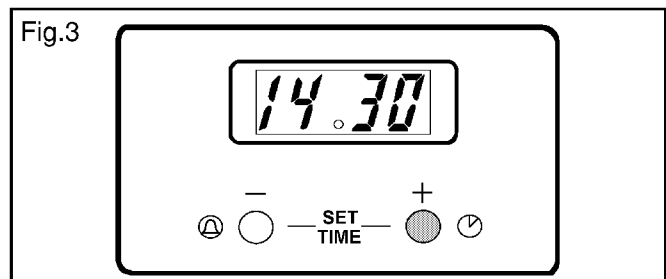
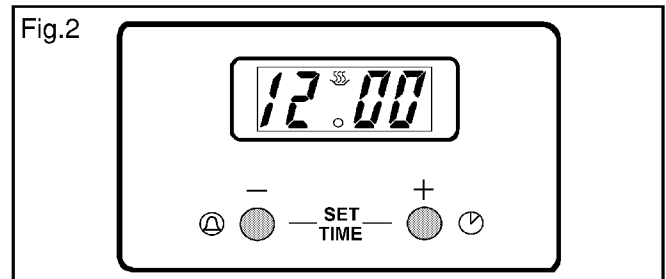
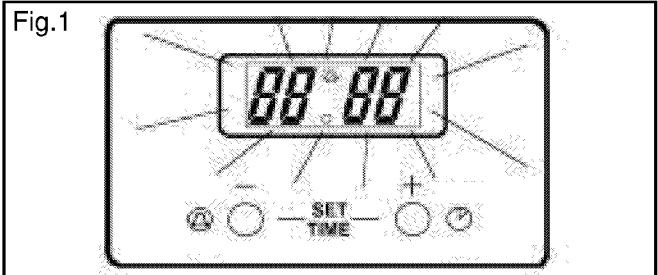
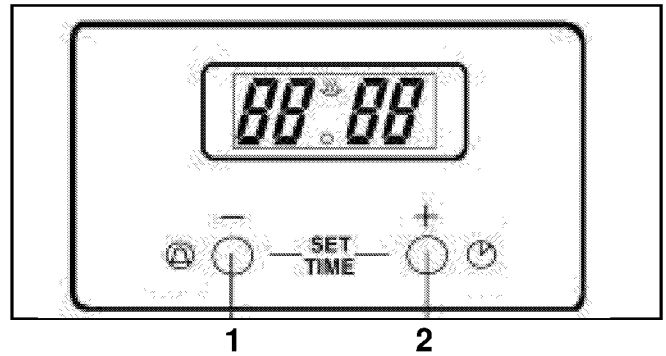

The minute minder will begin to count down once set. At the end of the timed period the minute minder will click, switching the oven OFF if in use.

An audible signal will sound for up to 30 seconds. The display will flash showing the time of day. See Fig. 6.

To stop the sound and flashing press button (1). The display will stop flashing and show the time of day, e.g. 15:00. The cooking symbol () will go out, see Fig. 7. If using the oven it will come on again once button (1) has been depressed. When cooking is complete remove food and turn OFF oven temperature control.

3. TO CANCEL THE MINUTE MINDER

Press and hold button (1) and the display will count down in one minute intervals to 00:00. See Fig 8. Release button (1).

If the oven is in use this will switch OFF after a few seconds.

To reset the time of day, press buttons (1) and (2) together. See Fig. 9.

4. THINGS TO NOTE

1. If at first you do not set the time of day correctly, reset the clock by pressing and holding button (1). The display will count back to 00:00. Release the button. After a few seconds the display will reset to show 12:00. To reset the time of day follow the procedure laid down in point 1 on page 11.
2. The time of day must be set before the oven will operate. There will be a few seconds delay before the oven switches on.
3. The minute minder function controls the oven only and will switch the oven OFF at the end of a timed period. This function is useful if you want to begin cooking now and have the oven switch OFF automatically.
4. If you have used the minute minder to time food cooking in the oven you will need to reset the timer by pushing both buttons before the oven can operate again.

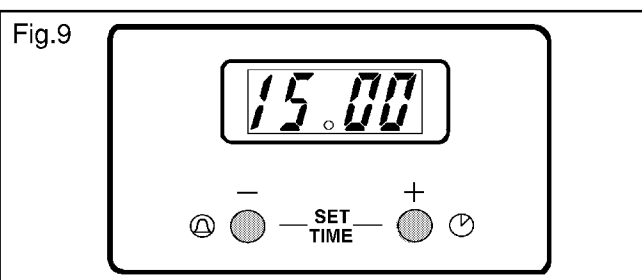
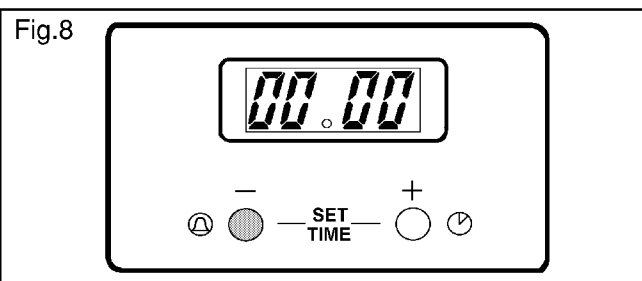
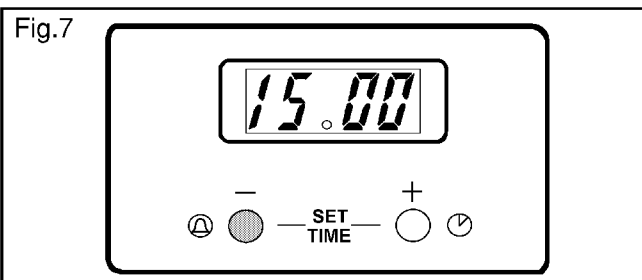
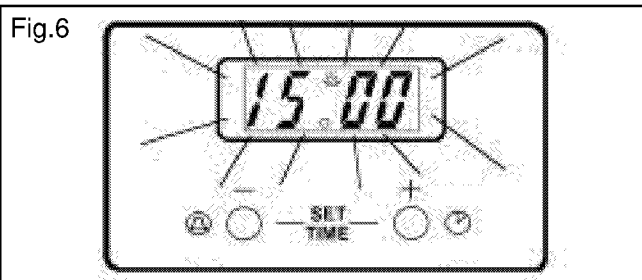

THE CERAMIC HOB

CAUTION - DO NOT USE THE COOKER IF THE CERAMIC GLASS IS DAMAGED. IF A FAULT OR CRACK BECOMES VISIBLE DURING COOKING, DISCONNECT THE COOKER IMMEDIATELY FROM THE ELECTRICITY SUPPLY AND CONTACT THE CUSTOMER SERVICE CENTRE.

USING THE HOTPLATES

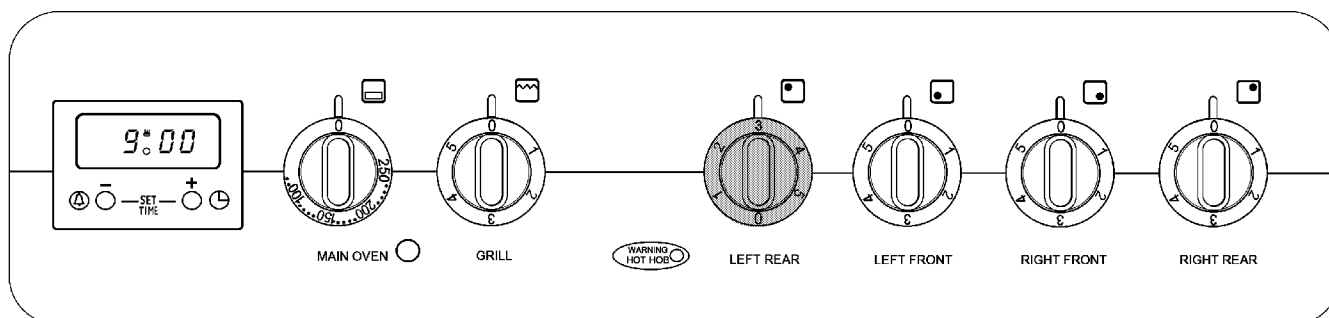

- To operate the hotplates, turn the control knobs in either direction to vary the heat setting. The highest number represents the hottest setting and the lowest represents the coolest setting. Choose a setting appropriate to the quantity and type of food to be cooked.
- This model has the added feature of one **Reflex** hotplate which reacts more quickly than other ceramic hotplates and is easily identified by its instant red glow.

RECOMMENDED SAUCEPANS

For speed and economy only good quality saucepans with flat bases and close fitting lids are recommended. The saucepan base should be approximately the same size as the cooking area, a base diameter of up to 225mm (9in) may be used on a 180mm (7in) heated area.

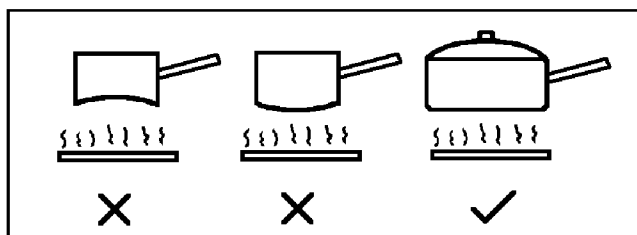

Ensure that new saucepans are well scrubbed to remove edges and take off any deposits left from manufacture.

Pressure cookers, preserving pans etc., should comply with the recommendations given above.

Traditional round bottomed Woks must not be used even with a stand. Woks with flat-bottomed bases are available and do comply with the above recommendations.

THINGS TO NOTE

Occasionally the heated areas may be seen to switch ON and OFF when higher heat settings are being used. This is due to a safety device which prevents the glass from overheating. Some switching ON and OFF when cooking at high temperatures, e.g. deep fat frying is quite normal, causes no damage to the hob and little delay in cooking times.

Excessive switching may however be caused by the use of an unsuitable saucepan or a saucepan which is smaller than the heated area. If excessive switching occurs, discontinue use of the saucepan.

HINTS AND TIPS

- Lift, rather than slide saucepans on and off the heated areas. This will reduce the risk of scratches and metal marks from saucepans with aluminium bases. Metal marks can be easily cleaned off providing they are not allowed to burn on.

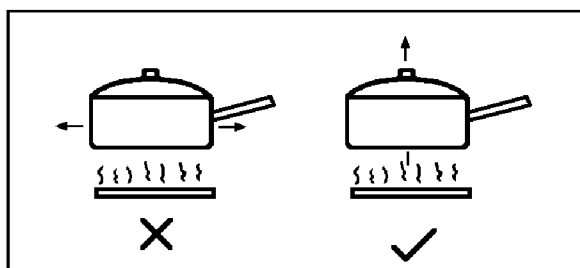

- Follow any guidelines provided by the saucepan manufacturer, particularly those relating to recommended heat settings.
- Avoid using thin, badly dented or distorted saucepans. Those with uneven bases should not be used.

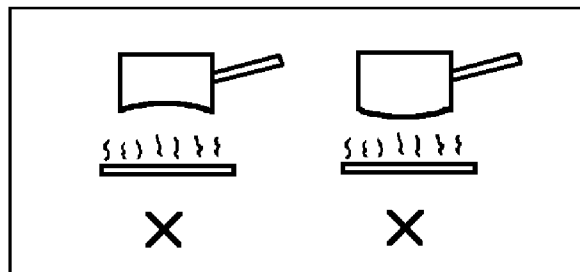

- To prolong the life of hotplates:-
 - Never use utensils with a skirt, e.g. a bucket.
 - Never use an asbestos mat.
 - Never leave the hotplates ON when not covered with a saucepan.

- Ensure that hob and saucepans are clean and dry before the start of cooking to reduce cleaning.
- Follow the cleaning instructions very closely to keep the hob looking like new.
- **If spillage occurs with sugar solutions, e.g. jams and syrups, it must be wiped from the hob before it sets and becomes hard otherwise damage to the hob will occur.**

HOT HOB INDICATOR

The hot hob indicator light situated on the control panel illuminates when the hob is switched on. The light will stay on when the hob is too hot to touch and go OFF when the hob has cooled.

DEEP FAT FRYING

SPECIAL FRYING NOTE:

For safety purposes when deep fat frying, fill the pan one-third full of oil, **DO NOT** cover the pan with a lid and **DO NOT** leave the pan unattended. In the unfortunate event of a fire, switch OFF at the electricity supply and cover the pan with a lid or damp cloth to assist in smothering the flames.

DO NOT use water on the fire. Leave the pan to cool for at least 30 minutes before moving it.

DO NOT leave the fat or oil in the frying pan on the hob to store it in case the hob is inadvertently switched ON.

1. Preparing the food

Seal the food by coating with flour, egg and breadcrumbs or batter. **Do not** use a basket with batter coated foods as they will stick.

2. Amount of oil

For safety purposes fill the pan only one-third full of oil.

3. Testing the temperature of the oil

It is advisable to use a thermometer to test the temperature of the oil. Alternatively, drop a small cube of bread into the oil which should brown in just under a minute if the oil is at the correct temperature of 190°C/375°F.

4. Cooking the food

Lower the food gently into the oil. **Do not** add too much food at once or the temperature of the oil will be reduced and may result in soggy, greasy food.

Turn the food if necessary; doughnuts float to the surface so will not brown on the upperside if not turned. Once cooked, drain the food on absorbent paper.

5. Double frying chips

Double frying will ensure good chips. First fry the chips for a few minutes at 170°C/340°F to seal the outside. Remove the chips from the oil. Increase the temperature of the oil to 190°C/375°F to finish cooking and brown the chips.

Chips may be kept for several hours after the first frying before finishing off with the second frying.

6. Frying temperatures

	Celsius Scale (°C)	Fahrenheit Scale (°F)
	150	300
First frying of potatoes	170	340
	175	350
	180	360
Second frying of potatoes	190	375
Frying chicken and fish	195	380
	200	390

PRESERVING

1. DO NOT use a pan that overlaps the perimeter of the hob trim.
2. To allow for a full rolling boil, the pan should be no more than one third full when all the ingredients have been added. It is better to use two pans rather than overfill one, or use half quantities.
3. Use firm fruit or vegetables and wash well before using.
4. Preserving sugar gives clear jam, however granulated sugar is cheaper and gives equally good flavour.
5. Crystallization may be caused if sugar is not completely dissolved before bringing jam to the boil. Over boiling will affect the flavour, setting properties and colour of the jam.
6. To test jam for setting:

If a jam thermometer is available, boil jam to 104°C. Marmalade should be boiled to 106°C.

If a jam thermometer is not available, remove pan from heat, place sample of jam on a cold dish and cool quickly (i.e. in a freezer or frozen food storage compartment of a refrigerator). When cold, it will crinkle and hold the mark of a finger run through it, if it is ready.

7. The scum should be removed as soon as possible after setting, but marmalade should be allowed to cool before potting to prevent the peel rising.

THE GRILL

CAUTION - ACCESSIBLE PARTS MAY BECOME HOT WHEN THE GRILL IS IN USE. CHILDREN SHOULD BE KEPT AWAY.

SELECTING THE GRILL

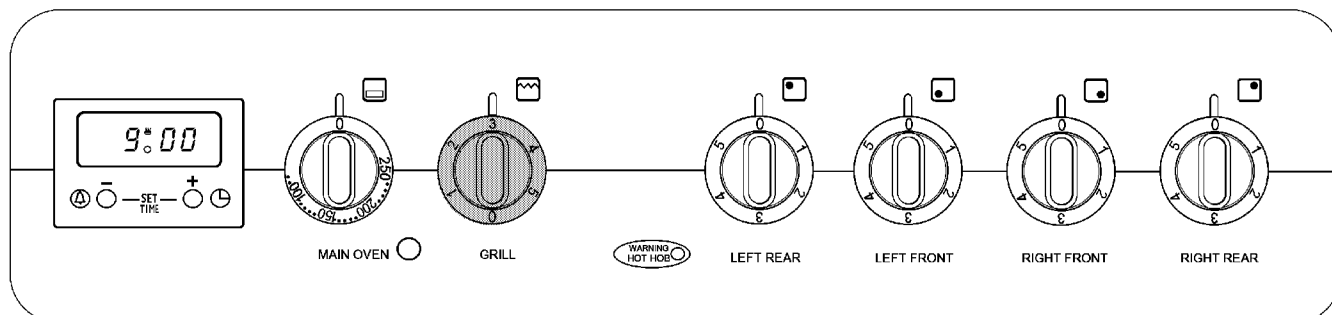

- To operate the grill open the grill door and turn the grill control clockwise to the required setting.
- The highest number represents the hottest setting and the lowest number the coolest setting.
- Setting 5 represents the grill on Full. At lower settings the grill may cycle on and off over time and you may prefer to use these settings for keeping food warm.

THINGS TO NOTE

THE GRILL DOOR MUST BE LEFT OPEN DURING GRILLING.

The cranked shelf **MUST** only be used in the grill compartment.

Some smoke from fat splashes may be evident as the grill cleans itself.

THE GRILL PAN AND HANDLE

The grill pan is supplied with a removable handle.

To insert the handle, press the button on the handle with the thumb and pivot the handle slightly upwards inserting the lip into widest part of the bracket. Move the handle towards the left, lower into position and release the button.

Ensure the handle is positively located.

When removing the handle, press the button on the handle with the thumb and pivot the handle slightly upwards and towards the right to remove from the bracket.

Ensure your hand is protected when inserting and removing the grill pan handle as the control panel trim and grill element can become very hot.

ALWAYS REMOVE THE GRILL PAN HANDLE DURING GRILLING.

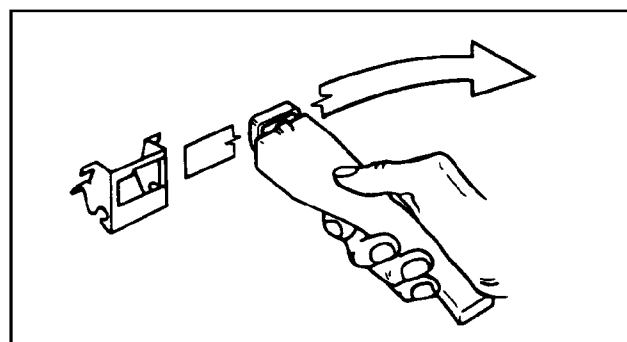

To correctly locate the grill pan on the shelf, ensure that the cut out on the underside of the handle bracket locates over the front bar of the shelf.

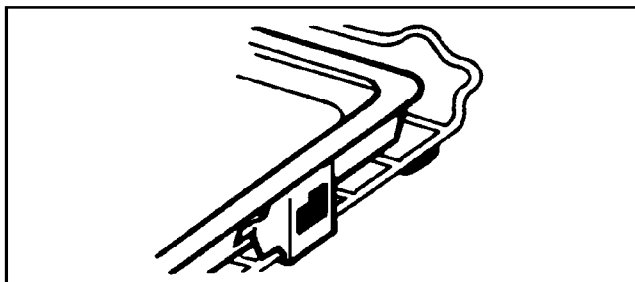

To check the progress of the food being grilled, the grill pan should be withdrawn on the shelf to tend the food during cooking, or the carrier shelf can be lifted away from the cooker and rested on a heat resistant work surface.

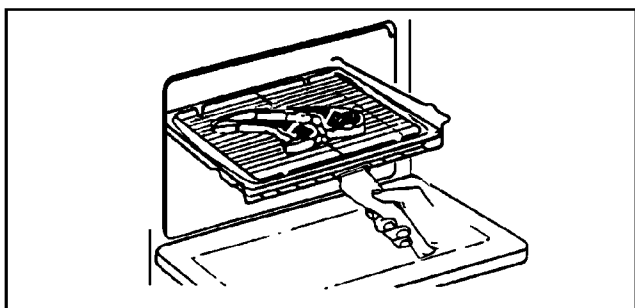

HINTS AND TIPS

- Food should be thoroughly dried before grilling to minimise splashing. Brush lean meats and fish lightly with a little oil or melted butter to keep them moist during cooking.
- Adjust the grid and grill pan runner position to allow for different heights of food.

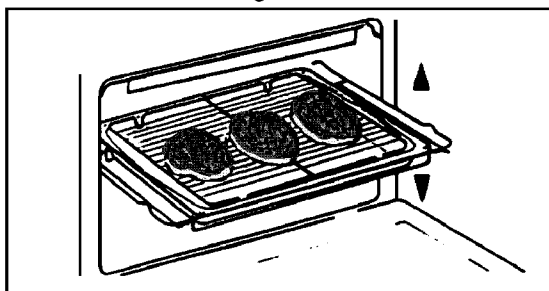

- The use of the trivet beneath the grid when grilling fatty food will keep fat splashing to a minimum.
- Place food on the grill pan grid in the grill pan or on the trivet in the grill pan.

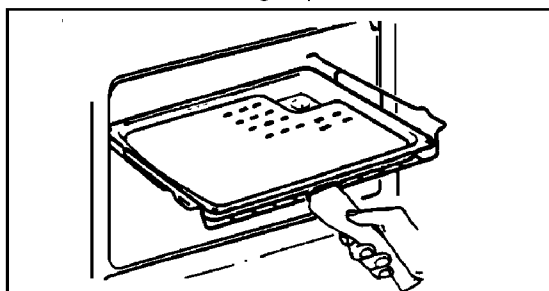

- Accompaniments such as tomatoes and mushrooms may be placed underneath the grid when grilling meats.

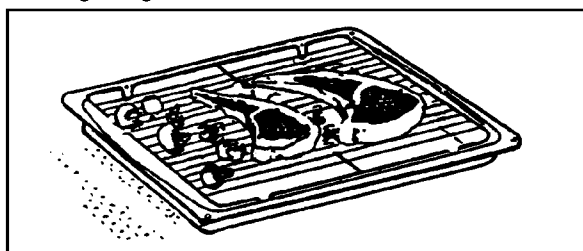

- Place food in the centre of the grill pan grid.
- When toasting bread use the cranked shelf in position 2 with the grid in the high position.
- Preheat the grill on a full setting for five minutes before cooking. Adjust the heat setting and the shelf as necessary during cooking.
- The food should be turned over during cooking as required.

GRILLING CHART

FOOD	SHELF	GRILL TIME (mins)
Bacon Rashers	2 crk.	2-3 each side
Beefburgers	2 crk.	6-10 each side
Chicken Joints	2 crk.	15-20 each side
Chops - Lamb	2 crk.	7-10 each side
Pork	2 crk.	10-15 each side
Fish - Whole Trout/Mackerel	2 crk.	8-12 each side
Fillets - Plaice/Cod	2 crk.	4-6 each side
Kebabs	2 crk.	10-15 each side
Kidneys - Lamb/Pig	2 crk.	4-6 each side
Liver - Lamb/Pig	2 crk.	5-10 each side
Sausages	2 crk.	10-15 each side
Steaks - Rare	2 crk.	3-6 each side
Medium	2 crk.	6-8 each side
Well Done	2 crk.	7-10 each side
Toasted Sandwiches	2 crk.	1¼-1½ each side

crk. = cranked shelf
Shelf positions are counted from the bottom upwards.

The times quoted above are given as a guide and should be adjusted to suit personal taste.

THE OVEN

SELECTING THE OVEN

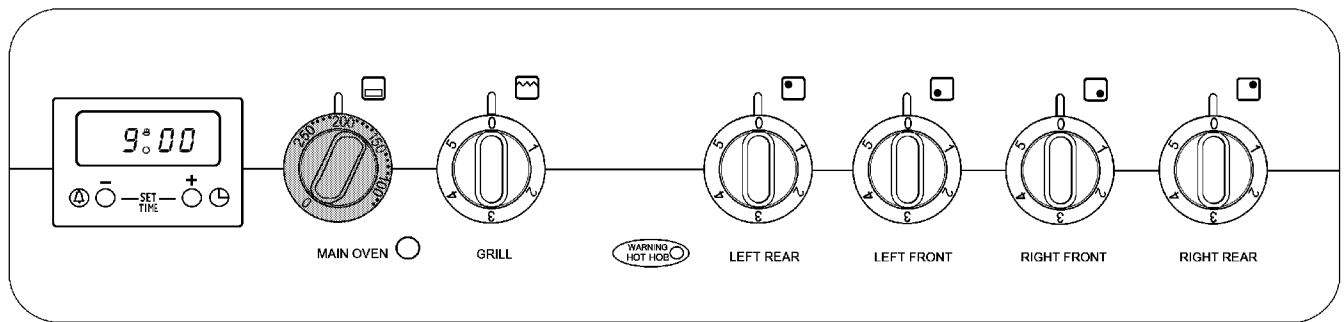

- To operate the oven turn the oven temperature control clockwise to the required setting.

THINGS TO NOTE

1. The oven indicator neon will glow until the oven has reached the required temperature and then go out. It will cycle ON and OFF periodically during cooking showing that the temperature is being maintained.

TO FIT THE OVEN SHELVES

The shelves should be fitted with the straight rods uppermost on the frame and the forms towards the back of the oven. If not fitted correctly the anti-tilt and safety stop mechanism will be affected.

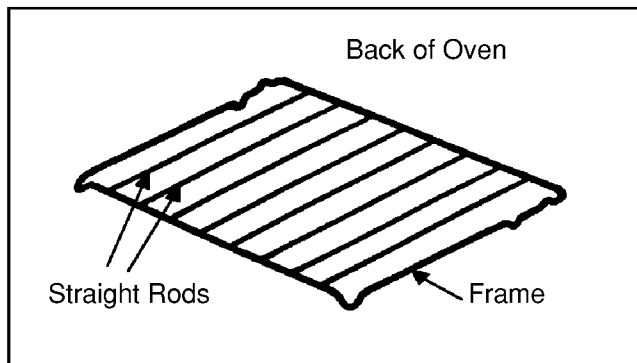

HINTS AND TIPS

- Arrange the shelves in the required positions before switching the oven ON. Shelves are numbered from the bottom upwards.

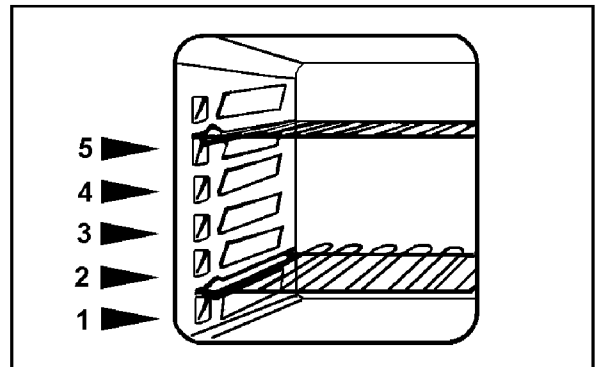

- The oven is fitted with side elements. The top of the oven is the hottest part of the oven and the bottom the coolest.
- Avoid placing food too close to the side element oven linings to prevent scorching.

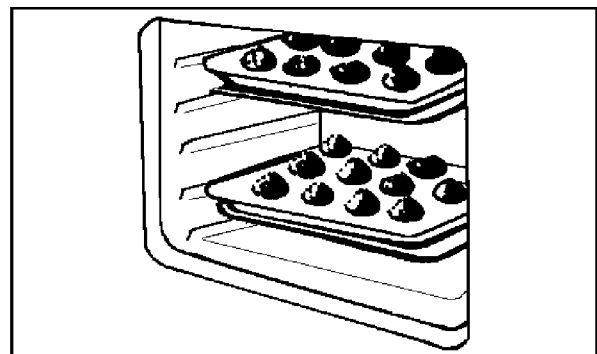

- Do not line any part of the oven with aluminium foil as it may cause damage or interfere with the air circulation.

For best results always:-

- Preheat the oven until the indicator neon goes out.
- For economy leave the oven door open for the shortest possible time particularly when placing food into a pre-heated oven.

OVEN COOKING CHART

The oven temperatures are intended as a guide only. It may be necessary to increase or decrease the temperatures by 10°C to suit individual preferences and requirements.

Shelf positions are counted from the bottom of the oven.

FOOD	MAIN OVEN SHELF POSITIONS	COOKING TEMP (°C)	APPROXIMATE COOK TIME (MINS)
Biscuits	4 and 5	190-200	10-20
Flapjacks	5	180-190	25-30
Shortbread	3	150-160	45-65
Bread			
Bread rolls/buns	1 and 5	210-220	20-30
Casseroles - beef	3	140-150	2-3 hours
Chicken casserole	3	180-190	1½ hours
Cakes:			
Small & Queen	2 and 5	180-190	20-25
Victoria sandwich	2 and 5	180-190	20-25
Gingerbread	3	150-160	1¼-1½ hours
Madeira	3	170-180	1-1¼ hours
Rich fruit	3	150-160	2¼-2¾ hours
Christmas	2	140-150	Depending on size 3-4½h
Meringues	2	90-100	2½-3 hours
Convenience Foods		Follow instructions on the pack	
Fish	3	180-190	20-30
Fish pie (potato topped)			
Shepherds pie	3	200-210	20-25
Fruit pies and crumbles	4	210-220	40-45
Milk puddings	2	150-160	1½-2 hours
Pastry:			
Choux- Chocolate eclairs	2 and 5	190-200	30-35
Profiteroles	2 and 5	180-190	20-30
Shortcrust- Mince pies	2 and 5	200-210	15-20
Flaky/Puff pies	3	220-230	30-40
Quiche Lorraine/tarts/flan			
Meat pie	5	200-210	30-45
Plate tarts/pies	2 and 5	200-210	30-45
Scones	2 and 5	230-240	8-12
Soufflés	3	200	30-40
Roasting Meat and Poultry	1	180-200	See Roasting Chart
Pasta e.g. Lasagne	3	200	30-40
Vegetable dishes			
Baked jacket potatoes	2 and 4	200	1-1½ hours
Baked stuffed marrow	5	200	30-35
Baked stuffed tomatoes	3	190	20-25
Roast potatoes	5	200-220	1-1½ hours
Yorkshire puddings:			
(large)	5	230	35-40
(individual)	2 and 5	230	35-40

ROASTING CHART

The oven temperatures are intended as a guide only. It may be necessary to increase or decrease the temperatures by 10°C to suit individual preferences and requirements.

MEAT	TEMPERATURES (°C)	COOKING TIME
	OVEN	
Beef	180-200	20-35 minutes per ½kg (1lb) and 20-35 minutes over
Beef, boned	180-200	25-35 minutes per ½kg (1lb) and 25-35 minutes over
Mutton and Lamb	180-200	25-35 minutes per ½kg (1lb) and 25-35 minutes over
Pork and veal	180-200	30-40 minutes per ½kg (1lb) and 30-40 minutes over
Ham	180-200	30-40 minutes per ½kg (1lb) and 30-40 minutes over
Chicken	180-200	15-20 minutes per ½kg (1lb) and 20 minutes over
Turkey and goose	180-200	15-20 minutes per ½kg (1lb) up to 3½kg (7lb) then 15 minutes per ½kg (1lb)
Duck	180-200	25-35 minutes per ½kg (1lb) and 25-35 minutes over
Pheasant	180-200	35-40 minutes per ½kg (1lb) and 35-40 minutes over
Rabbit	180-200	20 minutes per ½kg (1lb) and 20 minutes over
Potatoes with meat	180-200	according to size
Potatoes without meat	190-200	according to size

CARE AND CLEANING

ALWAYS SWITCH OFF THE ELECTRICITY SUPPLY BEFORE CLEANING

CLEANING MATERIALS

Before using any cleaning materials on your cooker, check that they are suitable and that their use is recommended by the manufacturer.

Cleaners that contain bleach should NOT be used as they may dull the surface finishes. Harsh abrasives should also be avoided. Multi-surface anti-bacterial cleaning products should not be used on the ceramic hob or on the surrounding trims.

CLEANING THE CERAMIC HOB

Make sure the ceramic glass is cool before cleaning. It is important to clean the ceramic hob daily to prevent soilage being burnt on.

Take care to avoid the hob trims when cleaning the ceramic glass as they may be damaged by the cleaning agents recommended.

DAILY CLEANING

Use the recommended Hob Brite Cleaner daily. If soilage is not allowed to burn on it will be much easier to clean off.

1. Apply a small amount of Hob Brite in the centre of each area to be cleaned.

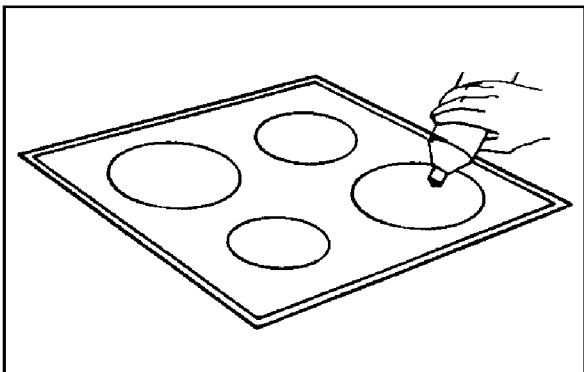

2. Dampen a clean paper towel or a plastic pad made specially for non-stick saucepans and rub vigorously until all marks are removed. This may take a few minutes.
3. Wipe off residues of cleaner with another damp paper towel and polish dry with a soft cloth.

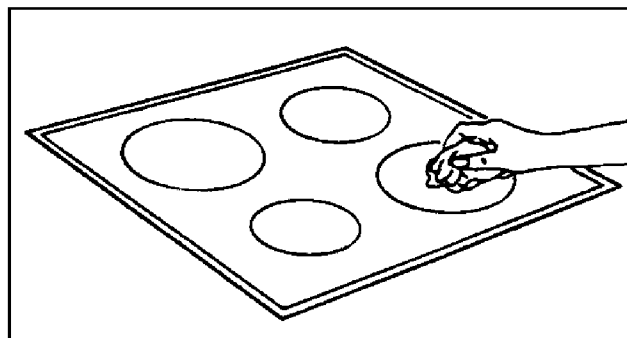

If Hob Brite is unavailable, one or more of the cleaning agents below may be used temporarily:

- a) Flash Cream Cleaner
- b) Jif Cream Cleaner
- c) Baking Soda

TO REMOVE MORE STUBBORN MARKS

1. Bar-Keepers Friend may be used to clean off more stubborn stains or to remove discolourations.

It may be necessary to rub the marks hard for several minutes. Use a plastic pad specially for non-stick saucepans with Bar-Keepers Friend.

2. Use the scraper supplied with the cooker with care at an angle of 45° to the hob to remove more stubborn marks. Then apply Hob Brite to clean off any remaining soilage.

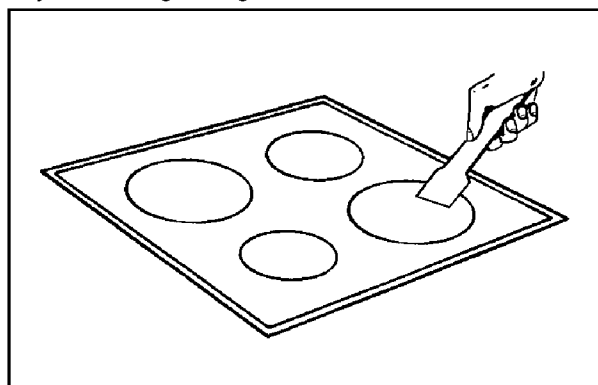

TO REMOVE DISCOLOURATIONS OR WHITE AND SILVER MARKS

These marks sometimes give the impression of being in or underneath the hob glass. They can almost always be removed provided they have not become excessively burnt on. Follow the instructions under 'To Remove More Stubborn Marks' above.

If this is unsuccessful, make up a paste of one part water to three parts Cream of Tartar and leave on the discoloured areas overnight. The marks should be easily removable the next day provided they have not been excessively burnt on. The paste should be thoroughly washed off afterwards.

HINTS AND TIPS

TO REDUCE HOB SOILAGE:

- Make sure the bottom of the saucepan and the cooking area are clean and dry before cooking begins.
- Ensure saucepans are large enough to accommodate food to avoid boil overs.
- If possible, wipe up spills and splatters as they occur, but take care to avoid steam burns.
- Avoid using a dishcloth or sponge to clean the hob. These may leave a layer of soiled detergent on the hob surface which will burn and discolour the next time the hob is used.
- Avoid the use of:
 - Household detergents and bleaches.
 - Impregnated plastic or nylon pads not described as suitable for non-stick saucepans.
 - Brillo pads, Ajax pads, steel wool pads.
 - Chemical oven cleaners, e.g. aerosols and oven pads.
 - Rust stain, bath and sink stain removers.
- **Any of the above products may cause damage to the hob.**
- It is dangerous to mix different cleaning products. The chemicals in them may react with each other with hazardous results.
- **SOILAGE FROM SUGAR SOLUTIONS MUST BE REMOVED FROM THE HOB BEFORE THE SYRUP HAS SET OTHERWISE DAMAGE TO THE HOB SURFACE WILL OCCUR.**
- Avoid placing plastic items, aluminium foil or dishes on the hot surface as this will cause damage to the hob.

CLEANING THE OUTSIDE OF THE COOKER

DO NOT use abrasive cleaning materials, or scourers on the outside of the cooker as some of the finishes are painted and damage may occur. Regularly wipe over the control panel, oven doors and cooker sides using a soft cloth and liquid detergent.

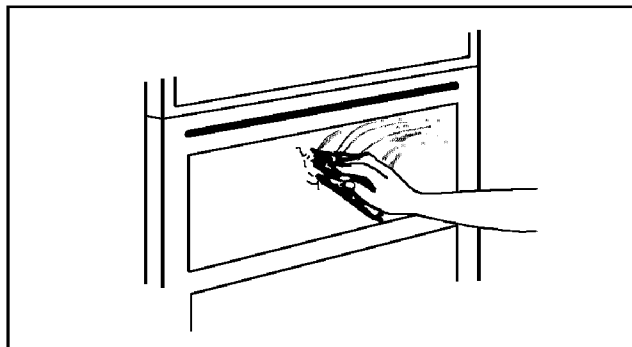

DO NOT ATTEMPT TO REMOVE ANY OF THE CONTROL KNOBS FROM THE PANEL AS THIS MAY CAUSE DAMAGE AND IS A SAFETY HAZARD

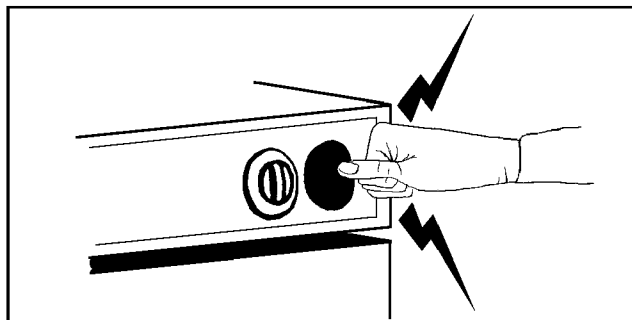

CLEANING THE GRILL PAN, GRILL PAN GRID, MEAT TIN AND OVEN SHELVES

All removable parts, except the grill pan handle can be washed in the dishwasher.

The grill pan, trivet, meat tin and oven shelves may be cleaned using a soap impregnated steel wool pad. The grill pan grid should be cleaned using hot soapy water. Soaking first in soapy water will make cleaning easier.

CLEANING INSIDE THE GRILL / OVEN COMPARTMENTS

The sides of the oven are coated with special Stayclean linings. The Stayclean linings should not be cleaned manually.

The vitreous enamel oven base, top and back panels, interior oven door and grill compartment can be cleaned using normal oven cleaners or aerosol oven cleaners with care. Ensure that the manufacturers instructions are followed and that all parts are well rinsed afterwards.

Aerosol cleaners must not be used on the Stayclean linings and must not come into contact with elements as this may cause damage.

For advice on how to keep the Stayclean linings in good condition see 'Care of Stayclean Surfaces'.

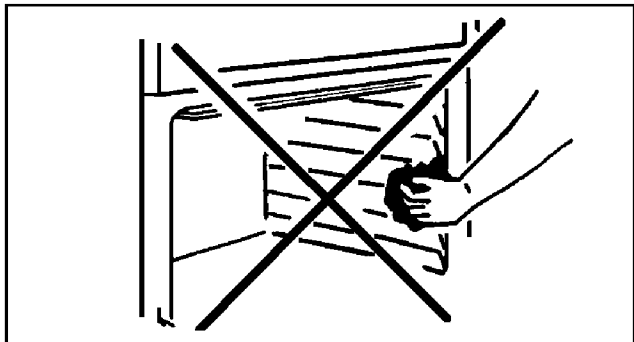

CARE OF STAYCLEAN SURFACES

Stayclean surfaces destroy splashes of food and fats when the oven temperature is raised to around 220°C.

It is a good idea to run the oven for an hour or two per week to ensure continued good performance from the Stayclean finish.

Do use the trivet in the roasting tin. During roasting, the fat from the joint will be contained beneath the trivet and therefore prevent it from splashing onto the Stayclean finish.

HINTS AND TIPS

- Manual cleaning of the Stayclean linings is NOT recommended. Damage will occur if oven sprays or abrasives of any kind are used.
- Slight discolouration and polishing of the Stayclean linings may occur in time. This does not affect the Stayclean properties in any way.
- A good time to allow the oven to run on is after the weekly roast. After removing the roast, turn the oven up to 220°C and allow to run for an hour or so. It is important NOT to allow a build-up of soilage as this can prevent the Stayclean from working.
- Follow the recommendations below to keep oven soilage to a minimum.
- Cook at the recommended temperatures. Higher temperatures during roasting will increase soilage. Try cooking at lower temperatures for an increased length of time, you will save energy and often the joint is more tender.
- Use minimal, if any, extra oil or fat when roasting meat, potatoes only require brushing with fat before cooking. Extra fat in the oven during roasting will increase splashing and soilage.
- It is NOT necessary to add water to the meat tin when roasting. The water and the fat juices from the joint create excessive splattering during cooking - even at normal temperatures, as well as causing condensation.
- Covering joints during cooking will also prevent splashing onto the interior surfaces. Removing the covering for the last 20 - 30 minutes will allow extra browning if required. Some large joints and turkeys especially benefit by this method of cooking, allowing the joint to cook through before the outside is over-browned.

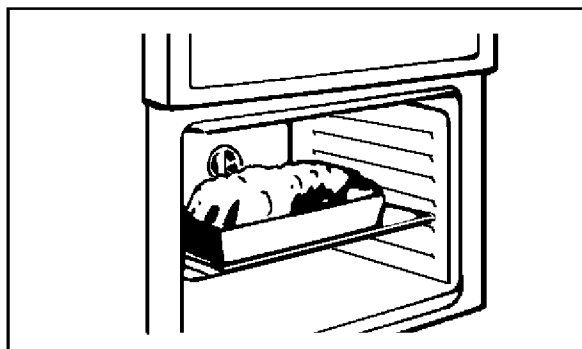

SOMETHING NOT WORKING?

We strongly recommend that you carry out the following checks on your appliance before calling a Service Engineer. It may be that the problem is a simple one, which you can solve yourself without the expense of a service call.

If our Service Engineer finds that the problem is listed below you will be charged for the call whether or not the appliance is under guarantee.

The cooker does not work at all:

- * Check that the appliance has been wired in and is switched on at the wall.
- * Check that the main cooker fuse is working.
- * Check that the instructions for the operation of the timer are being closely followed. (see page 11).

The clock and minute minder does not work:

- * Check that the instructions for the timer are being closely followed.
- * Check that the grill door has not been accidentally closed during grilling. If it has, open the door, turn off the grill control and allow the cooker to cool.

The hotplates and oven work but the grill does not:

- * Check that you have carefully followed the instructions for operation of the grill.

The grill and hotplates work but the oven does not:

- * Check that the operating instructions for the timer are being closely followed. (see page 11).

The oven temperature is too high or low:

- * Check that the recommended temperatures and shelf positions are being used (see pages 19 and 20). Be prepared to adjust the temperatures up or down by 10°C to achieve the results you want.

If the oven is not cooking evenly or the side opening door will not stay open:

- * Check that the cooker is level.
- * Check that the recommended temperatures and shelf positions are being used.

SERVICE AND SPARE PARTS

HELP US TO HELP YOU

Please determine your type of enquiry before writing or telephoning.

SERVICE

It is a recommendation by the manufacturer that annual servicing of the product is done by the manufacturers approved service organisation.

In the event of your appliance requiring service Tricity Bendix Limited have an arrangement with Electrolux Group Service.

Before calling out an Engineer, please ensure you have read the details under the heading "Something Not Working?" and have the model number and purchase date to hand. The telephone number and address for service is detailed on the list headed "Customer Service Centres".

PLEASE NOTE that all enquiries concerning service should be addressed to your local Customer Service Centre.

CONSUMER CARE DEPARTMENT

FOR GENERAL ENQUIRIES concerning your Tricity Bendix cooker or further information on Cooking, Cooling or Washing products, you are invited to contact our Consumer Care Department by letter or telephone as follows:

Consumer Care Department
Tricity Bendix Limited
99 Oakley Road
Luton
Bedfordshire LU4 9QQ
Tel: (01582) 585858

CUSTOMER SERVICE CENTRES

The Regional Electricity Companies are responsible for the servicing of cookers sold by their own outlets. The telephone numbers can be found in the telephone directory.

Service for cookers bought from other outlets can be obtained by calling the nearest Customer Service Centre on the numbers given below. The areas are defined by postcode for easy reference.

CENTRE	POSTAL DISTRICTS	SERVICE APPOINTMENTS	ADDRESS
ABERDEEN	AB	01224-696569	Electrolux After Sales Service Northeast Appliance Service 8 Cornhill Arcade Cornhill Drive Aberdeen AB2 5UT
ARGYLL	PA 24-61	01369-703161	Electrolux After Sales Service T.D.C. Refrigeration Briar Hill 7 Hill Street Dunoon Argyll PA23 7AL
BARNSTAPLE	EX18-23, 31-39	01271-328826	Electrolux After Sales Service McBain Refrigeration Unit 4 Upcott Avenue Pottington Industrial Estate Barnstaple N.Devon EX31 1HN
BORDERS	TD	01573-224411	Electrolux After Sales Service James Stewart & Son 2-8 Wood Market Kelso Borders TD5 7AX
BRISTOL	BA BS TA SP	0117-9211876	Electrolux After Sales Service Unit BE46 PO Box 372 Bristol BS99 1UD
CANVEY	E EC EN N NW W WC AL CB HA HP LU MK SG UB WD CM CO IG RM SS IP NR PE14-19,30-38	0181-443-3464 0181-965-9699 0181-965-9699 01268-694144 01603-667017	Electrolux After Sales Service 2-4 Sandhurst Kings Road Canvey Island SS8 0QY
CARDIFF	CF NP1-4, 6, 9-44,SA1-18 SA21-32	01222-460131	Electrolux After Sales Service Guardian Industrial Estate Clydesmuir Road Tremorfa Cardiff CF2 2QS
CUMBRIA	CA	01228-594747	Electrolux After Sales Service E.T.B. Services Carlisle Enterprise Centre James Street Carlisle CA2 5AP
DUMFRIES & GALLOWAY	DG1-14	01387-265166	Electrolux After Sales Service Allan Crossan (Service) 93 Irish Street Dumfries Scotland
DUNDEE	Parkinson Cowan Gas Only	01382-642828	Electrolux After Sales Service Tayside Refrigeration 3-7 Blackness Street Dundee DD1 5LR
DUNDEE	DD1-14 PH8-18	01250-876285	Electrolux After Sales Service 1 Brogan Domestic 41 Leslie Street Blairgowrie Perthshire PH10 6AT

GLASGOW	EH FK G KA KY1-16 ML PA1-23, PH1-7	0141-647-4381	Electrolux After Sales Service 20 Cunningham Road Clyde Estate Rutherglen Glasgow G73 1PP
GUERNSEY	All Codes	01481-46931	Guernsey Electricity PO Box 4 Vale Guernsey Channel Islands
HAVERFORDWEST	SA33-39 SA41-44 SA61-73	01437-710914	Electrolux After Sales Service C Butherway 1 Church Road. Roch Haverfordwest Dyfed Wales SA62 6AG
HEREFORD	HR1-9 LD1-8 SY7 ,18 NP5 NP7-8	01432-340334	Electrolux After Sales Service Domestic Repair Centre Unit 3 Bank Buildings Cattle Market Hereford HR4 9HX
HULL	YO4 YO11-18 YO25 HU1-19 DN14	01482-585678	Electrolux After Sales Service John Sizer Unit 1 Boulevard Unit Factory Estate Hull HU3 4AY
INVERNESS	IV1-28, 30-36, 52-56, PH19-26, 42-44 KW1-14	01463-792952	Electrolux After Sales Service Highland Appliances Unit 3B3 Smithton Industrial Est Smithton Inverness
INVERNESS	PH30-41 IV40-51	01855-821315	Electrolux After Sales Service George Ross Electrical Forrestry Workshop Inchree Onich Inverness-shire PH33 6SE
ISLE OF WIGHT	PO30-41	01983-872552	Electrolux After Sales Service Wyatts Electrical Service 4 Forelands Road Bembridge Isle of Wight PO35 5XW
ISLE OF ARRAN	KA27	01770-302909	Electrolux After Sales Service Arran Domestic Unit 4 The Douglas Centre Brodick Isle of Arran KA27 8AJ
ISLE OF MAN	IM	01624-663455	Electrolux After Sales Service Manx Electricity Service Workshop North Quay Douglas Isle of Man
ISLE OF MULL	PA62-75	01688-302262	Electrolux After Sales Service B Hogg Braeside Raeric Road Tobermory Isle of Mull PA75 6PU
JERSEY	ALL CODES	01534-505050	Jersey Electricity Company PO Box 45 Queens Road St Helier Jersey, Channel Islands JE4 8NY
LAMPETER	SA19,20 SA40 SA45-48 SY23-25	01570-423020	Electrolux After Sales Service Lampeter Domestic Appl. Services Unit 16 Lampeter Ind. Est. Lampeter SA48 7DY

LANCASTER	LA1-23	01772-316175	Electrolux After Sales Service NL Services Unit 333 Ranglet Road Walton Summit Bamber Bridge Preston, Lancashire PR5 8AR
LEEDS	BD DN1-7, 10-12, HD HG HX LS S WF YO1-3, 5-8 DE NG1-22 & 25	0113-2608511	Electrolux After Sales Service 64-66 Cross Gates Road Leeds LS15 7NN
LINCOLN	DN21 sub codes 1 2 & 5 only, LN1, 2, 4,5,6 LN3 sub codes 4 & 5 only LN8-10 NG 23,24 31-34 PE1-13, 20-25	01522-514603	Electrolux After Sales Service Brian Hudson Unit 8 Stonefield Park Clifton Street Lincoln LN5 8AA
LIVERPOOL	FY PR L WN CH CW WA (Not WA 14/15)	0151-2541724	Electrolux After Sales Service Unit 1 Honeys Green Precinct Honeys Green Lane West Derby Liverpool L12 9JH
MANCHESTER	BB BL OL M SK WA14 & 15 only	0161-4777758	Electrolux After Sales Service Unit 30 Oakhill Trading Estate Devonshire Road Worsley Manchester M28 3PT
NEWTON ABBOTT	EX1-17 TQ PL1-9, 16, 19-21	01626-65909	Electrolux After Sales Service South West Domestic Service Unit 2 Zealley Industrial Est Kingsteignton Newton Abbott South Devon TQ12 3SJ
NORTH WALES	LL	01745-591616	Electrolux After Sales Service GMS (Cymru) Unit 2 Coed- Parc Abergele Road Rhuddlan Clwyd, Wales LL18 5UG
NORTHERN	DL TS DH YO21, 22 DH NE SR	01325-301400 0191-493-2025	Electrolux After Sales Service PO Box 40 Preston Road Aycliffe Industrial Estate Newton Aycliffe, Co Durham DL5 6XA
NORTHERN IRELAND EAST	BT1-30, 36-57, 63-67	01232-746591	Electrolux After Sales Service Unit C3 Edenderry Industrial Estate 326 Crumlin Road Belfast BT14 7EE
NORTHERN IRELAND WEST	BT31-35, 60-62, 68-82, 92-94	01861-510400	Electrolux After Sales Service G & O (Armagh) Service Owenmore House Kilwee Business Park Upper Dunmurray Lane Belfast BT17 0HD
NUNEATON	B DY ST TF WR WS WV GL NN OX SN CV LE	0121-358-7076 0121-358-5051 01993-704411 01203-350420	Electrolux After Sales Service Unit 23-24 Alliance Business Pk Townsend Drive Nuneaton Warwickshire CV11 6RX
ORKNEY	KW15-17	01856-875457	Electrolux After Sales Service Refrigeration Sales and Services Hatson Ind. Estate Kirkwall Orkney
REDDITCH	TBA	TBA	Electrolux After Sales Service Heming Road Washford Redditch Worcestershire B98 0DH

REDRUTH	TR1-20, 26, 27 PL10-15, 17, 18, 22-35	01209-314407	Electrolux After Sales Service Cornwall Domestic Service Unit 7D Pool Industrial Estate Wilson Way Redruth Cornwall TR15 3QW
ROTHSAY	PA20	01700-504777	Electrolux After Sales Service D McGlashan Walker Walker Engineering Glenmhor Upper Serpentine Rothesay PA20
SHETLAND	Own Sales	01595-692225	Electrolux After Sales Service Tait Electronic Systems Ltd. Holmsgarth Road Lerwick Shetland ZE1 OPW
SHETLAND	Own Sales	01595-692855	Electrolux After Sales Service Bolts Shetland Ltd. 26 North Road Lerwick Shetland ZE1 OPE
SHETLAND	ZE2	01806-566546	Electrolux After Sales Service Leask Electrical Harsdale Symbister Shetland ZE2 9AA
SHREWSBURY	SY1-6 SY8-17 SY19-22	01743-450279	Electrolux After Sales Service BLI Service 6 Harlescott Barn Harlescott Lane Shrewsbury SY1 3SY
SOUTH COAST	BN16-18. GU27-35 PO1-22. BH DT SO TR21-25	01705-667411 01705-667411 0117-9211876	Electrolux After Sales Service Limberline Road Hilsea Portsmouth Hampshire PO3 5JJ
SOUTH HUMBERSIDE	DN 8, 9, DN15-20 DN21 sub codes 3,4 only DN31-40 LN (3 sub code 6 only), 7 LN11-13	01472-267978	Electrolux After Sales Service John Robinson (Electrical) Unit 74 New Enterprise Centre King Edward Street Great Grimsby DN31 3JP
TONBRIDGE	SL GU1-26. RG CT DA ME TN BN1-15, 20-27, RH TW BR CR SE SW SM KT	01252-24505 01732-357722 01273-694341 0181-658-9069	Electrolux After Sales Service Unit 30 Deacon Trading Estate Morley Road Tonbridge Kent TN9 1RA

We, Tricity Bendix, undertake that if within 12 months of the date of the purchase this Tricity Bendix appliance or any part thereof is proved to be defective by reason only of faulty workmanship or materials, we will, at our option repair or replace the same FREE OF ANY CHARGE for labour, materials or carriage on condition that:

- The appliance has been correctly installed and used only on the electricity supply stated on the rating plate.
- The appliance has been used for normal domestic purposes only and in accordance with the manufacturers operating and maintenance instructions.
- The appliance has not been serviced, maintained, repaired, taken apart or tampered with by any person not authorised by us. Any servicing or repairs carried out by any unapproved third party will invalidate the approvals status of this product.
- All service work under this guarantee must be undertaken by a Tricity Bendix service representative or authorised agent.
- Any appliance or defective part replaced shall become the Company's property.
- This guarantee is in addition to your statutory and other legal rights.

EXCLUSIONS

This guarantee does not cover:

- Damage or calls resulting from transportation, improper use or neglect, the replacement of any light bulbs or removable parts of glass or plastic.
- Cost incurred for calls to put right an appliance which is improperly installed or calls to appliances outside the United Kingdom.
- Appliances found to be in use within a commercial environment, plus those which are subject to rental agreements.
- Products of Tricity Bendix manufacture which are not marketed by Tricity Bendix.
- EEC Countries. The standard guarantee is applicable but subject to the owners responsibility and cost to ensure the appliance meets the standards set by the Country of which the product is taken. Electrolux Aftersales Service in the Country concerned, with whom Tricity Bendix have an arrangement, will be pleased to advise further.

RATING PLATE REFERENCE

MAKE AND MODEL NO.	SERIAL NO.	DATE OF PURCHASE

IMPORTANT NOTICE

In line with our continuing policy of research and development, we reserve the right to alter models and specifications without prior notice.

This handbook is accurate at the date of printing, but will be superseded and should be disregarded if specifications or appearance are changed.

TRICITY BENDIX



Better Products. Better Value.

TRICITY BENDIX, 99 OAKLEY ROAD, LUTON, BEDFORDSHIRE, LU4 9QQ

A Division of Emaco Limited · Registered in England No. 176547 · Registered Office. 101 Oakley Road, Luton LU4 9RJ.

MODEL NO.
SI 255



PART NO.
311283703

Free Manuals Download Website

<http://myh66.com>

<http://usermanuals.us>

<http://www.somanuals.com>

<http://www.4manuals.cc>

<http://www.manual-lib.com>

<http://www.404manual.com>

<http://www.luxmanual.com>

<http://aubethermostatmanual.com>

Golf course search by state

<http://golfingnear.com>

Email search by domain

<http://emailbydomain.com>

Auto manuals search

<http://auto.somanuals.com>

TV manuals search

<http://tv.somanuals.com>