



OPERATING AND INSTALLATION INSTRUCTIONS

MODEL NO.
SIE 400

TECHNICAL DETAILS

MODEL NO. SIE 400

Voltage: 230/240 Volts AC 50Hz

Wattage: 11.5/12.5 kW

Height: 900mm

Width: 550mm

Depth: 600mm

This appliance complies with: European Council Directive 73/23/EEC.
EMC Directive 89/336/EEC.
CE Marking Directive 93/68/EEC.

CONTENTS

Please refer to the sections in this book which are appropriate to the features on your model.

Technical Details	2
Contents	3
Preface	5
Safety	6
Before Installation	6
During Operation	6
After Use	7
General	7
Introduction	8
Rating Plate	8
Installation	8
Reversible Main Oven Door	9
General Notes on using your Cooker	9
About Condensation and Steam	9
The Cooling Fan for the Controls	9
Grill and Oven Furniture	9
Getting to Know Your Cooker	10
The Control Panel	10
The Timer	11
The Sealed Hotplates	13
Recommended Saucepans	13
Hints and Tips	13
Deep Fat Frying	14
Preserving	14
The Dual Grill	15
Uses of the Grill	15
Selecting the Grill	15
Things to Note	15
The Grill Pan and Handle	15
Hints and Tips	16
Grilling Chart	16
The Top Oven	17
Uses of the Top Oven	17
Selecting the Top Oven	17
Things to Note	17
To Fit the Top Oven Shelf	17
Hints and Tips	18
Automatic Cooking	18
The Main Fan Oven	19
Uses of the Fan Oven	19
Selecting the Fan Oven	19
Things to Note	19
To Fit the Main Oven Shelves	20
Hints and Tips	20
Automatic Cooking	20

CONTENTS

Oven Cooking Chart	21
Roasting Chart	22
Defrost Feature	23
Uses of Defrost Feature	23
Selecting Defrost	23
Things to Note	23
Hints and Tips	23
Care and Cleaning	24
Cleaning Materials	24
Cleaning the Sealed Hotplates and Hotplate Trims	24
Things To Note	24
Cleaning the Outside of the Cooker	24
Cleaning the Grill Deflector, Grill Pan, Grill Pan Grid, and Oven Shelves	25
Cleaning Inside the Grill/Oven Compartments	25
Care of Stayclean Surfaces	25
Hints and Tips	25
Something not Working?	26
Service and Spare Parts	27
Customer Service Centres	28
Guarantee Conditions	30

PREFACE

Dear Customer,

Thank you for buying a Tricity Bendix cooker. With our 80 years experience in developing and manufacturing the very best in U.K. cookers, you can be assured that you have purchased a hard working, reliable, quality product.

Tricity Bendix cookers comply with British Standard safety and performance requirements. They have been approved by BEAB (British Electrotechnical Approvals Board) and are covered by a 12 month parts and labour guarantee.

To get the best from your new Tricity Bendix cooker, we ask that you PLEASE READ THESE INSTRUCTIONS CAREFULLY. Particular attention should be made to cooking times and temperatures which may differ from your previous cooker.

It is most important that this instruction book is retained with the appliance for future reference. Should the appliance be sold, or if you move house and leave the appliance, always ensure that the book remains with the appliance. This will enable the new owner to be acquainted with the functioning of the appliance and the relevant warnings.

Please read the whole instruction book before attempting to use the appliance ensuring you follow the recommendations given.

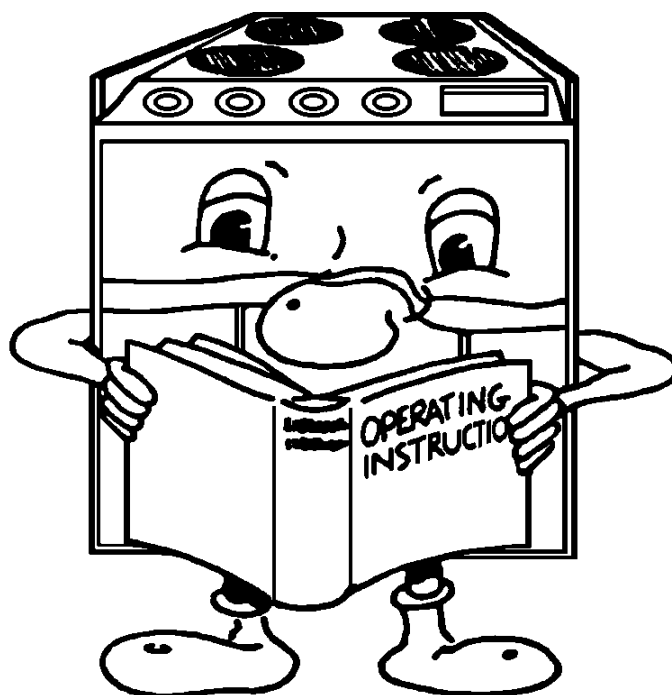

SAFETY

THESE WARNINGS ARE PROVIDED IN THE INTERESTS OF YOUR SAFETY. ENSURE THAT YOU UNDERSTAND THEM ALL BEFORE INSTALLING OR USING THE COOKER.

PLEASE
READ
CAREFULLY

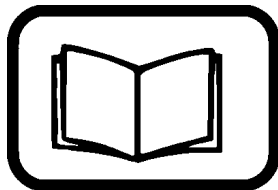

BEFORE INSTALLATION



This appliance is heavy and care **must** be taken when moving it.



Ensure that all packaging, both inside and outside the appliance, has been removed before the appliance is used.

If the cooker is to be placed on a base, measures must be taken to prevent the cooker slipping from the base.



Do not try to move the appliance by pulling the door handles.

The electrical installation work **must** be undertaken by a qualified electrician/competent person.



It is dangerous to alter or modify the specifications of the product in any way.



After installation, please dispose of the packaging with due regard to safety and the environment.

DURING OPERATION



Do not use this appliance if it is in contact with water. **Never** operate it with wet hands.



This appliance is designed to be operated by adults. Young children **must not** be allowed to tamper with the product or play with the controls.

During use the cooker becomes Hot. Care should be taken to avoid touching heating elements inside the oven.

Accessible parts especially around the grill area may become hot when the appliance is in use. Children should be **kept away** until it has cooled.



Take **great care** when heating fats and oils as they will ignite if they become too hot.

This product has been designed for cooking edible foodstuffs only, and **must not** be used for any other purposes.



Never place plastic or any other material which may melt in the oven or on the hob.



Ensure cooking utensils are large enough to contain foods to prevent spillages and boil overs.

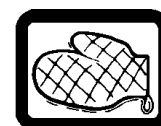

The handles of saucepans which are smaller than the heated area on the hob will become hot. **Ensure** your hand is protected before handling the pan.



Take care to follow the recommendations given for tending the food when grilling.

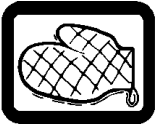

Always use oven gloves to remove and replace food in the oven.

Ensure that all vents are left unobstructed to ensure ventilation of the oven cavity.

Ensure that the anti-tilt shelves are put in place correctly. Refer to instructions on page 17 and 20.

Never line any part of the appliance with aluminium foil.



Always stand back from the appliance when opening the oven door to allow any build up of steam or heat to release.



Do not place sealed cans or aerosols inside the oven. They may explode if they are heated.

Do not leave the hotplates switched on for long periods when not covered by a saucepan. The controls may overheat.

AFTER USE



Ensure that all control knobs are in the OFF position when not in use.



For hygiene and safety reasons this appliance should be kept clean at all times. A build-up of fats or other foodstuffs could result in a fire, especially in the grill pan.



Do not leave utensils containing foodstuffs, e.g. fat or oil in or on the appliance in case it is inadvertently switched ON.

Cookers and hobs become **very hot**, and retain their heat for a long period of time after use. Children should be kept well away from the appliance until it has cooled.

GENERAL



Under no circumstances should repairs be carried out by inexperienced persons as this may cause injury or serious malfunction. This product should be serviced by an authorised Service Engineer and only genuine approved spare parts should be used. Details of servicing and repair arrangements are given on page 27 of this book.



Do not stand on the appliance or on the open oven door.



Do not hang towels, dishcloths or clothes from the appliance or its handle. They are a safety hazard.

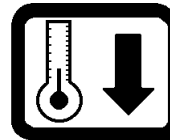

Always allow the cooling fan to cool the cooker down before switching off at the wall prior to carrying out any cleaning or maintenance work.



Only clean this appliance in accordance with the instructions given in this book.

Your safety is of paramount importance.

Therefore, if you are unsure about any of the meanings of these WARNINGS contact the:

Customer Care Department
Telephone 0870 5 950950

INTRODUCTION

WARNING: THIS APPLIANCE MUST BE EARTHED

RATING PLATE

Record the model, product and serial numbers on the back cover of this instruction book, from the rating plate. This is situated on the lower front frame of the appliance and can be seen upon opening the top oven door.

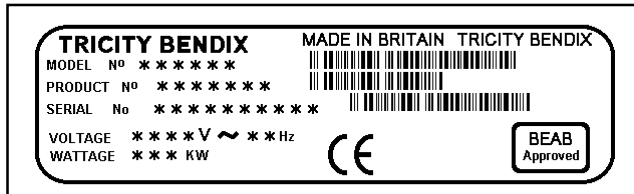

The appliance must be protected by a suitably rated fuse or circuit breaker. The rating of the appliance is given on the rating plate.

Do not remove the rating plate from the cooker as this may invalidate the guarantee.

INSTALLATION

If your cooker has been damaged in transit, contact your supplier immediately. **DO NOT** attempt to install it.

Your cooker left the factory fully packaged to protect it from damage. If it is delivered without packaging and damage has occurred, the manufacturer cannot accept responsibility. Contact your supplier for advice.

Once the packaging has been removed the cooker should only be moved by hand. **DO NOT** use a sack barrow or any other aid to lift the cooker as damage may occur.

Connection to the electricity supply must be carried out by a qualified electrician/competent person.

The electrical connection should be made using a double pole isolating switch (cooker socket) with at least 3mm contact separation. The cable must have conductors of sufficiently high cross-sectional area to prevent overheating and deterioration.

Six square millimetres (6.00mm²) is the recommended cross-section area.

The cable should be routed away from potentially hot areas marked by X in the diagram below.

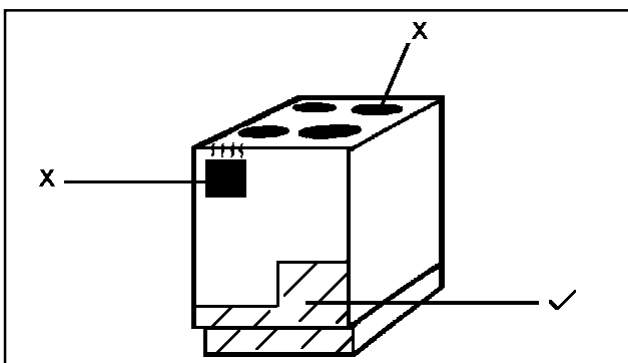

To move the cooker, open the main oven door and lift the cooker by holding inside the top of the compartment.

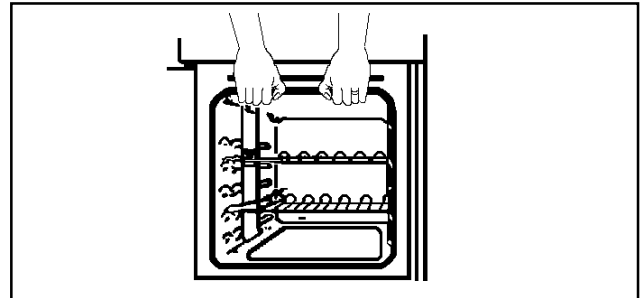

This is a type Y appliance which means it is free-standing and can be fitted with cabinets on one or both sides. It may also be fitted in a corner setting.

Side walls which are above hob level should be protected by heat resistant non-combustible material and **MUST NOT** be nearer than 40mm to the hob side.

A nominal air gap of 2mm all around the cooker is required to enable the cooker to be moved into position.

Always ensure an air gap is maintained at hotplate level. Tiles or other forms of deep wall covering should not obscure this gap.

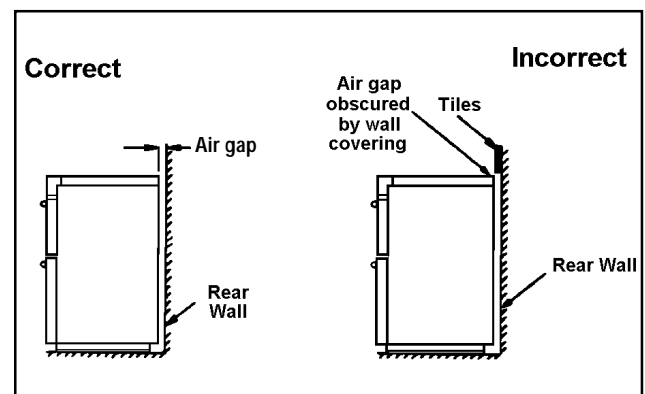

Overhanging surfaces or a cooker hood should be a minimum of 685mm above the hob.

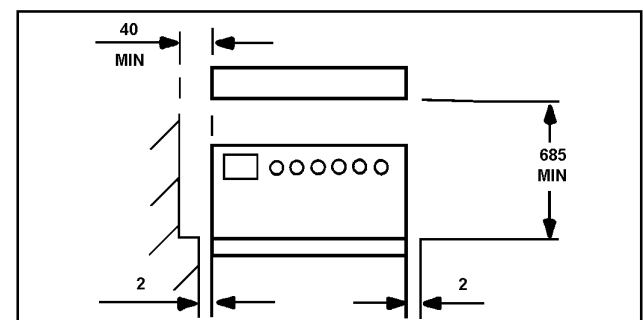

It is important to ensure that the appliance is level after installation. Levelling feet are fitted to the appliance to accommodate uneven floors.

REVERSIBLE MAIN OVEN DOOR

If you require the oven door to be hinged on the opposite side, you will need to contact a qualified Service Engineer. See page 28 for your nearest Service Centre. PLEASE NOTE that a charge will be made.

GENERAL NOTES ON USING YOUR COOKER

We suggest that you run the oven elements for 10 - 15 minutes at 220°C to burn off any residue from their surfaces.

The procedure should be repeated with the grill for approximately 5 - 10 minutes.

During this period an odour may be emitted, it is therefore advisable to open a window for ventilation.

ABOUT CONDENSATION AND STEAM

When food is heated it produces steam similar to a boiling kettle. The ovens are vented to allow some of this steam to escape. However, always stand back from the appliance when opening the oven door to allow any build up of steam or heat to release.

If the steam comes into contact with a cool surface on the outside of the appliance, e.g. a trim, it will condense and produce water droplets. This is quite normal and is not caused by a fault on the appliance.

To prevent discolouration, regularly wipe away condensation and also soilage from surfaces.

For your safety wallcoverings at the rear of the appliance should be securely fixed to the wall.

THE COOLING FAN FOR THE CONTROLS

The cooling fan comes on immediately when the grill or top oven are switched on and after a time when the main fan oven is in use. The operation of the cooling fan is temperature dependent in the case of the main oven and the cooling fan may not switch in at all at low temperature settings or where the main oven has only been used for a short time.

The cooling fan may run on after the control knobs have been switched off until the cooker has cooled. If an automatic programme has been set the cooling fan does not come on until the cooktime begins. Do not switch the cooker off at its power point until the cooling fan has cooled the cooker down.

GRILL AND OVEN FURNITURE

The following items of oven furniture have been supplied with the cooker: If you require replacements of any of the items listed below, please contact your local Service Force Centre quoting the relevant part number.

1 grill pan

(311409401)

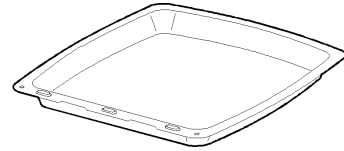

1 grill pan handle

(311468100)



Note

If you require an additional handle for your grill pan, this can be ordered from your local Tricity Bendix Service Centre by quoting part number 311479800\6.

1 grill pan grid

(311419801)

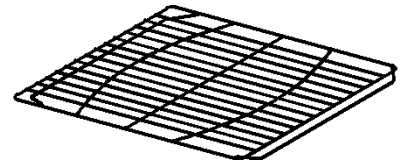

1 grill deflector

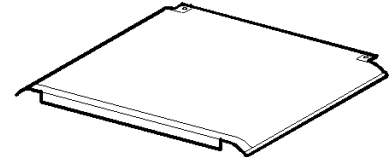

1 cranked shelf for grilling and top oven cooking only

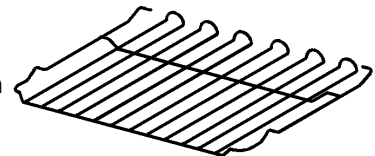

2 straight shelves for main oven cooking

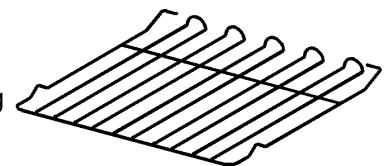

The grill deflector sits above the grill element and prevents fat splashing onto the grill roof. The deflector may be easily removed for cleaning.

Scuffing of the Stayclean main oven lining by the oven furniture pack may occur during transit. These marks will disappear after the oven elements have been burnt off for the first time.

GETTING TO KNOW YOUR COOKER

THE CONTROL PANEL

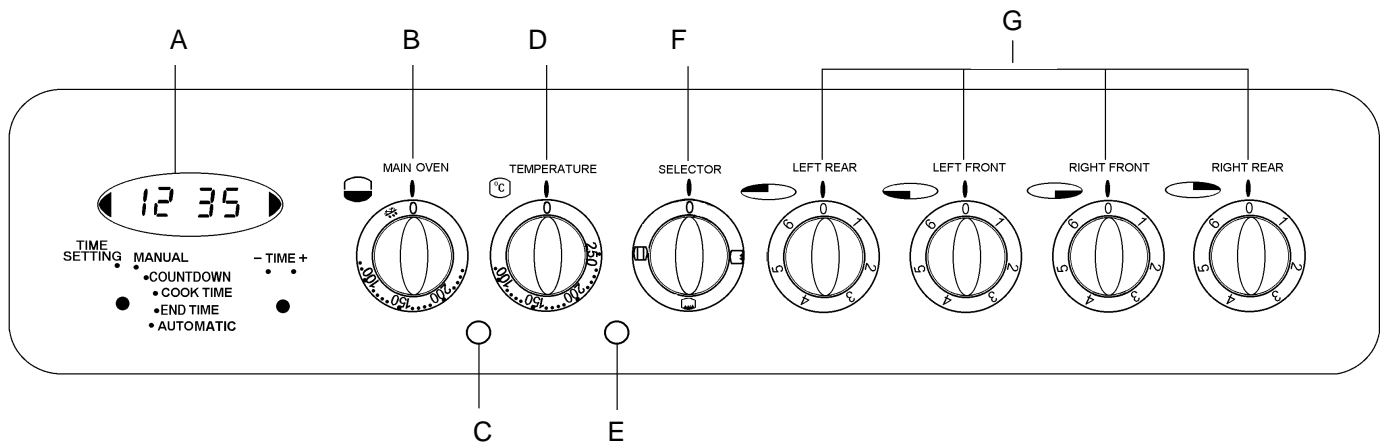

FEATURES

- A - The Timer
- B - Main Oven Temperature Control
- C - Main Oven Indicator Neon
- D - Top Oven Temperature Control
- E - Top Oven Indicator Neon
- F - Selector Control
- G - Hotplate Controls

THE TIMER

Please note that this is a 24 hour clock, for example 2.00 pm is shown as 1400.

In the following pages we explain how to set the controls. Read through them a few times until you are familiar with the procedure. We have supplied a plastic card as a quick reference when setting the timer.

If the oven is switched off on the wall, or there is a loss of power, the clock will stop and you will not be able to use the ovens. When you first switch the electricity supply on, the timer display will flash.

TO SET THE TIME OF DAY

Turn the selector knob to 'Manual' then turn to 'Time Setting'.

Set the correct time by turning and holding the setting knob clockwise. Adjust the time by turning the setting knob in either direction.

Turn the selector knob back to 'Manual'.

TO USE THE MINUTE MINDER

Turn the selector knob to 'Countdown'. Turn the setting knob clockwise until the display shows the time you want. The bell symbol (🔔) will be showing and this will stay lit up during the time. Our diagram shows the timer set to 5 minutes.

If you change your mind and want to cancel the time you have set, simply turn the setting knob anticlockwise. Then turn the selector to 'Manual'.

When you are using the minute minder you can make the clock show the time of day by turning the selector knob to 'Manual'. The bell symbol will stay on to remind you that the minute minder is set. At the end of the timed period an alarm will sound and the bell symbol will go out.

Switch off the alarm by turning the selector knob to 'Time Setting'. Then turn to 'Manual' and the time of day will show in the display.

Note:

You can use the minute minder when an automatic sequence has been set, as long as you remember the following point.

- 1 Turn the selector knob to 'Automatic' as soon as you have entered the timed period into the display.

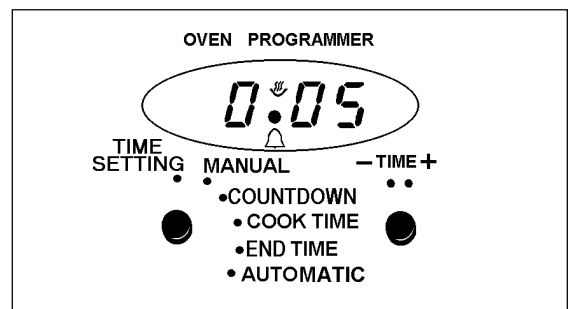
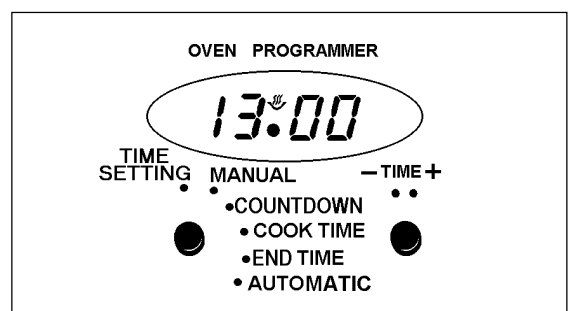
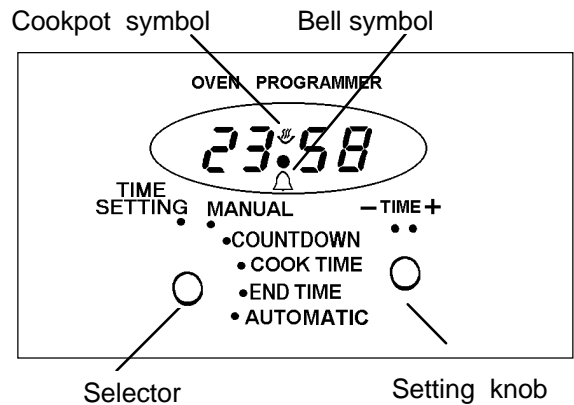

AUTOMATIC CONTROL

You can only use the automatic control for the main oven. When you use the automatic controls for the first time it's probably best to choose a time when you are at home. That way you can check to make sure you've set everything correctly and you'll feel much more confident when you are away from home in the future.

SETTING THE CONTROLS FOR AUTOMATIC USE

This is very easy. All you have to do is work through the steps below. The clock will work out the rest for itself.

- 1 Is the electricity supply on?
- 2 Is the clock showing the correct time? To adjust turn the selector knob to 'Manual' then turn to 'Time Setting'. Turn the setting knob in either direction.
- 3 How long will the food take to cook? Turn the selector knob to 'Cook Time'. Then turn the setting knob until the length of time you want the food to cook shows in the display. The maximum cooking time is 10 hours. 'Auto' will show in the display.
- 4 What time do you want the food to be cooked by? Turn the selector knob to 'End Time'. Turn the setting knob until the time the oven is to switch off shows in the display. The cookpot () will go out. The 'End Time' must not be more than 23 hours 59 minutes from the time of day. For example if the time of day is 9.00 am the latest 'End Time' will be 8.59 am the next day.
- 5 Set to automatic. Turn the selector knob to 'Automatic'.
- 6 Turn on the oven control. Turn the oven control to the required setting.

The time shown on the right gives an example of setting the automatic controls when the time is 9.00 am, the food is to be cooked for 2½ hours and the food is needed at 6.00 pm (1800 hours).

The clock will work out what time the oven will switch itself on and it will turn the oven off at the end. Once the automatic sequence is finished there will be an alarm to remind you that you need to set the oven for manual operation. To do this turn the selector knob to 'Manual'. Turn off the oven control. If you change your mind and want to cancel a programme that you have set simply turn to 'Time Setting' and then to 'Manual'.

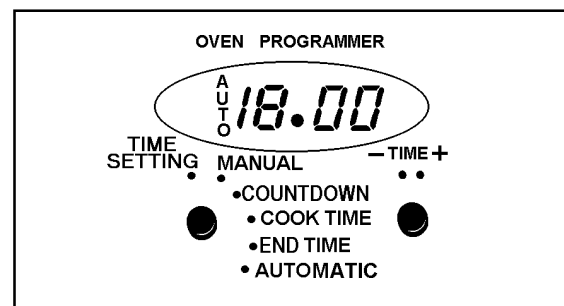
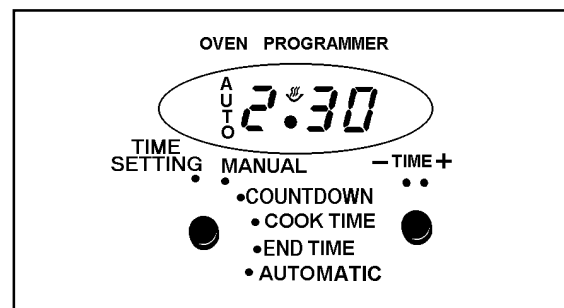
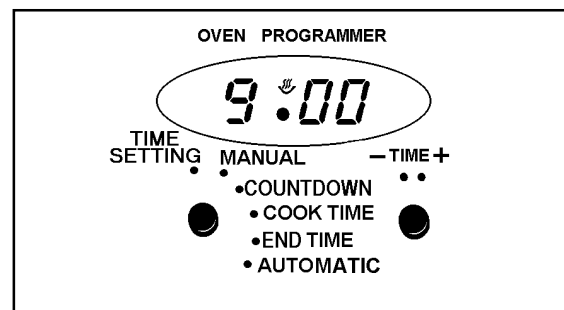

THE SEALED HOTPLATES

BEFORE USING THE HOTPLATES FOR THE FIRST TIME

Turn the control knob to a medium/high setting and allow the hotplate to heat, uncovered by a saucepan for 3-5 minutes. This hardens the protective coating on the hotplates, and makes it more resistant to normal use. A harmless smoke will be given off from the hotplates.

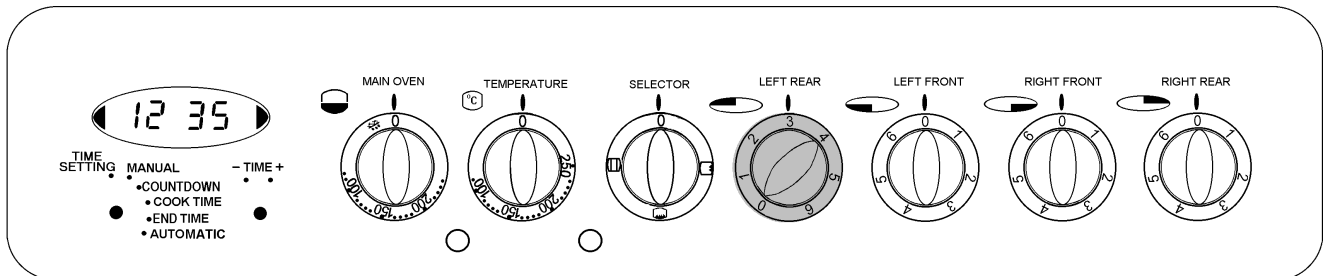

- To operate the hotplates turn the control knobs in either direction to vary the heat setting.
- The highest number represents the hottest setting and the lowest represents the coolest setting. Choose a setting appropriate to the quantity and type of food to be cooked.

RECOMMENDED SAUCEPANS

For speed and economy only good quality saucepans with flat bases and close fitting lids are recommended.

To check the flatness of the saucepan, place a ruler across the pan base, hold at eye level and look for light showing. There should be very little or no light visible between the ruler and the pan base.

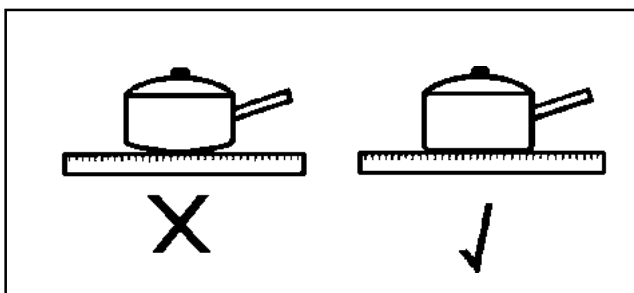

The size of the base of the saucepan should be the same or up to 3cm/1 inch larger than the hotplate. If the base is too small, energy will be wasted, boilovers will also be more difficult to deal with as spillage will fall directly onto the hotplate.

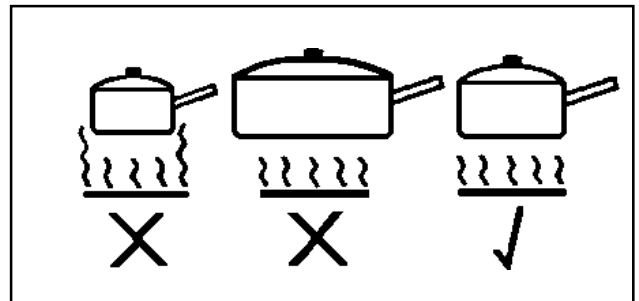

Pressure cookers, preserving pans, etc., should comply with the recommendations given above.

Traditional round-bottomed Woks must not be used even with a stand. Woks with flat-bottomed bases are available and do comply with the above recommendations.

HINTS AND TIPS

- Avoid the use of decorative covers as they can cause condensation to form on the hotplates which may lead to deterioration.
- Follow any guidelines provided by the saucepan manufacturer, particularly those relating to recommended heat settings.
- Avoid using thin, badly dented or distorted saucepans as they can lead to sticking and burning of food.
- To prolong the life of the hotplates:-
 - Never use utensils with a skirt, e.g. a bucket
 - Never use an asbestos mat

DEEP FAT FRYING

SPECIAL FRYING NOTE:

For safety purposes when deep fat frying, fill the pan one-third full of oil, DO NOT cover the pan with a lid and DO NOT leave the pan unattended. In the unfortunate event of a fire, switch OFF at the electricity supply and cover the pan with a lid or damp cloth to assist in smothering the flames.

DO NOT use water on the fire. Leave the pan to cool for at least 30 minutes before moving it.

DO NOT leave the fat or oil in the frying pan on the hob to store it in case the hob is inadvertently switched ON.

1. Preparing the food

Seal the food by coating with flour, egg and breadcrumbs or batter. **Do not** use a basket with batter coated foods as they will stick.

2. Amount of oil

For safety purposes fill the pan only one-third full of oil.

3. Testing the temperature of the oil

It is advisable to use a thermometer to test the temperature of the oil. Alternatively, drop a small cube of bread into the oil which should brown in just under a minute if the oil is at the correct temperature of 190°C/375°F.

4. Cooking the food

Lower the food gently into the oil. **Do not** add too much food at once or the temperature of the oil will be reduced and may result in soggy, greasy food.

Turn the food if necessary; doughnuts float to the surface so will not brown on the upperside if not turned. Once cooked, drain the food on absorbent paper.

5. Double frying chips

Double frying will ensure good chips. First fry the chips for a few minutes at 170°C/340°F to seal the outside. Remove the chips from the oil. Increase the temperature of the oil to 190°C/375°F to finish cooking and brown the chips.

Chips may be kept for several hours after the first frying before finishing off with the second frying.

6. Frying temperatures

	Celsius Scale (°C)	Fahrenheit Scale (°F)
	150	300
First frying of potatoes	170	340
	175	350
	180	360
Second frying of potatoes	190	375
Frying chicken and fish	195	380
	200	390

PRESERVING

1. DO NOT use a pan that overlaps the perimeter of the hob trim.

2. To allow for a full rolling boil, the pan should be no more than one third full when all the ingredients have been added. It is better to use two pans rather than overfill one, or use half quantities.

3. Use firm fruit or vegetables and wash well before using.

4. Preserving sugar gives clear jam, however granulated sugar is cheaper and gives equally good flavour.

5. Crystallization may be caused if sugar is not completely dissolved before bringing jam to the boil. Over boiling will affect the flavour, setting properties and colour of the jam.

6. To test jam for setting:

If a jam thermometer is available, boil jam to 104°C. Marmalade should be boiled to 106°C.

If a jam thermometer is not available, remove pan from heat, place sample of jam on a cold dish and cool quickly (i.e. in a freezer or frozen food storage compartment of a refrigerator). When cold, it will crinkle and hold the mark of a finger run through it, if it is ready.

7. The scum should be removed as soon as possible after setting, but marmalade should be allowed to cool before potting to prevent the peel rising.

THE DUAL GRILL



USES OF THE GRILL

CAUTION - ACCESSIBLE PARTS MAY BECOME HOT WHEN THE GRILL IS IN USE. CHILDREN SHOULD BE KEPT AWAY.

The grill is a dual circuit grill which means that the full area of the grill can be used or for economy purposes, the centre section only can be used when cooking smaller quantities of food.

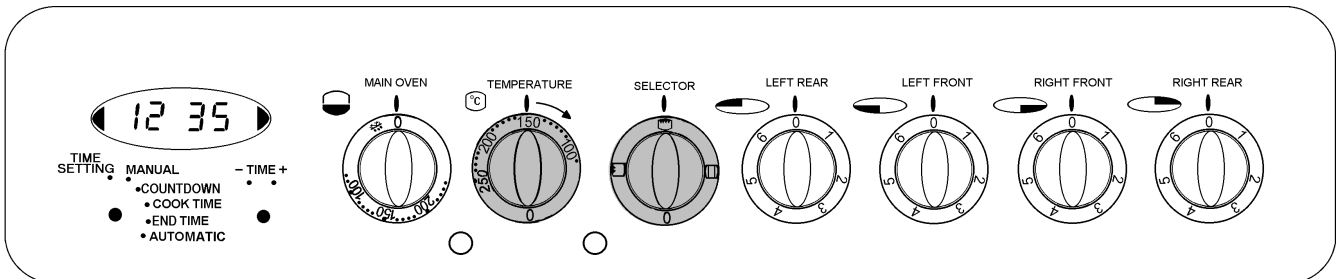
SELECTING THE GRILL



- Select the grill function for full grill 
- Select the grill function for centre section only 
- Turn the temperature control knob to the right as far as it will go. This is the hottest setting.
- To use the grill at lower settings, turn the temperature control knob so that 110°C or 150°C on the knob lines up with the off dot on the panel.

THINGS TO NOTE

- The cooling fan will operate in conjunction with the grill. For more details on the operation of the cooling fan see page 9.

THE GRILL DOOR MUST BE LEFT OPEN DURING GRILLING.

If the grill door is accidentally closed during grilling, a safety device incorporated in the appliance will cut out the grill to indicate to the user there is a fault. This will occur after approximately 10 minutes.

The cranked shelf **MUST** only be used in the grill compartment, but a straight shelf from the main oven may be used to provide alternative positions.

Some smoke from fat splashes may be evident as the grill cleans itself.

The top oven **cannot** be operated when the grill is in use. If the grill and top oven controls are selected at the same time, only the top oven will operate.

The inner grill element may appear to glow slightly brighter than the outer element. This is quite normal.

THE GRILL PAN AND HANDLE

The grill pan is supplied with a removable handle.

To attach the handle, place the wirework under the cut out in the pan so that the metal plate hooks over the top of the grill pan.

Slide the handle to the left and over the central bump on the grill pan.

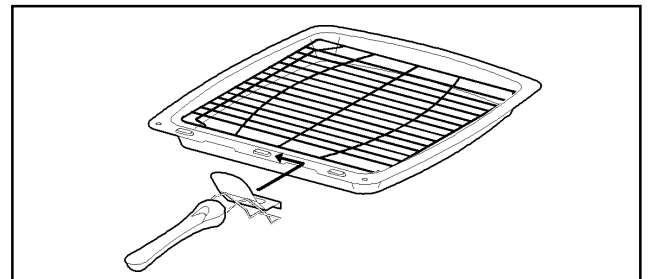

Ensure the handle is correctly located. It is not necessary to remove the grill pan handle during grilling.

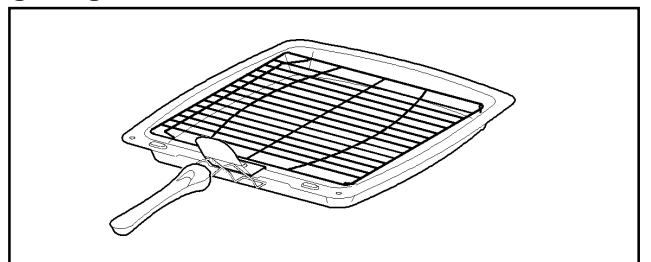

To remove the handle, slide the handle to the right and lift the handle away from the cut out on the grill pan.

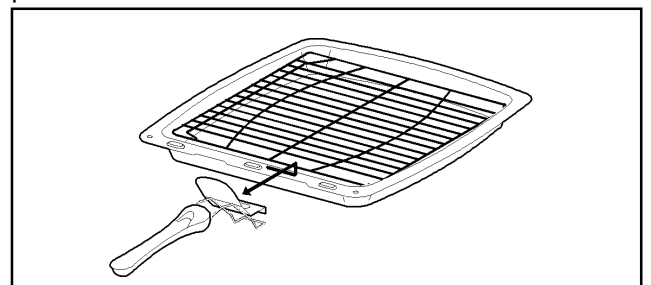

Place the grill pan on the shelf so that the pan is positioned centrally beneath the grill.

HINTS AND TIPS

- In order to become acquainted with the performance of the Dual Grill it is advisable to check food regularly when grilling.
- Food should be thoroughly dried before grilling to minimise splashing. Brush lean meats and fish lightly with a little oil or melted butter to keep them moist during cooking.
- Adjust the height of the grilling grid and grill pan runner position to allow for different foods.
- Accompaniments such as tomatoes and mushrooms may be placed underneath the grid when grilling meats.

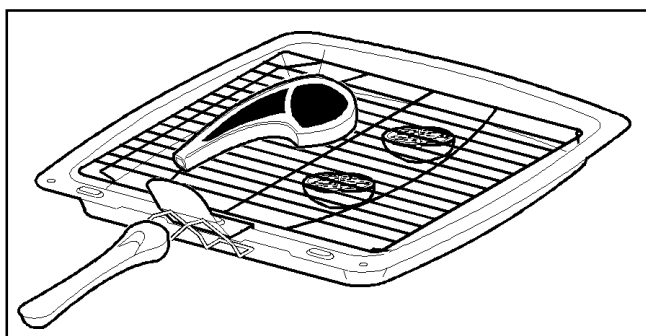

- When toasting bread use the cranked shelf in position 2 with the grid in the high position.
- Preheat the grill on a full setting for a few minutes before sealing steaks or toasting. Adjust the heat setting and the shelf as necessary during cooking.
- The food should be turned over during cooking as required.
- When using the centre section of the dual grill, ensure food is positioned centrally on the grill pan grid in the grill pan.

NOTE

If you require an additional handle for your grill pan, this can be ordered from your local Tricity Bendix Service Centre by quoting part number 311479800\6.

GRILLING CHART

FOOD	SHELF	GRILL TIME (mins)
Bacon Rashers	2 crk.	2-3 each side
Beefburgers	2 crk.	6-10 each side
Chicken Joints	2 crk.	15-20 each side
Chops - Lamb	2 crk.	7-10 each side
Pork	2 crk.	10-15 each side
Fish - Whole Trout/Mackerel	2 crk.	8-12 each side
Fillets - Plaice/Cod	2 crk.	4-6 each side
Kebabs	2 crk.	10-15 each side
Kidneys - Lamb/Pig	2 crk.	4-6 each side
Liver - Lamb/Pig	2 crk.	5-10 each side
Sausages	2 crk.	10-15 each side
Steaks - Rare	2 crk.	3-6 each side
Medium	2 crk.	6-8 each side
Well Done	2 crk.	7-10 each side
Toasted Sandwiches	2 crk.	1¼-1½ each side

crk. = cranked shelf

Shelf positions are counted from the bottom upwards.

The times quoted above are given as a guide and should be adjusted to suit personal taste.

THE TOP OVEN

USES OF THE TOP OVEN

The top oven is the smaller of the two ovens. It is heated by elements in the top and bottom of the oven. It is designed for cooking on one level and for smaller quantities of food. It gives especially good results if used to cook fruit cakes, sweet or savoury flans or quiche.

The top oven is also ideal for use as a warming compartment to warm dishes and keep food hot. Use a temperature setting of 80-100°C on the top oven control dial.

SELECTING THE TOP OVEN

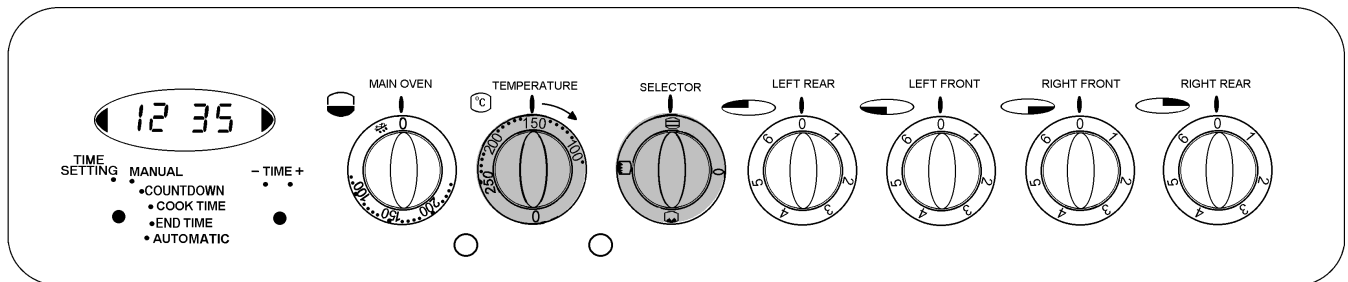

- Turn the top oven function selector to 
- Turn the top oven temperature control to the required setting.
- The cooling fan will operate immediately with the top oven. For more details on cooling fan operation see page 9.

THINGS TO NOTE

1. The grill cannot be operated when the top oven is in use. If the grill and top oven controls are selected at the same time, only the top oven will operate.
2. The top oven indicator neon will glow until the oven has reached the desired temperature and then go out. It will then turn ON and OFF showing that the oven temperature is being maintained.
3. The cooling fan will operate immediately with the top oven. See page 9 for more details on the operation of the cooling fan.

TO FIT THE TOP OVEN SHELF

The cranked shelf must only be used in the top oven compartment but a straight shelf from the main oven may be used to provide alternative positions.

The shelf should be fitted with the straight rods uppermost on the frame and the forms towards the back of the oven. If not fitted correctly the anti-tilt and safety stop mechanism will be affected.

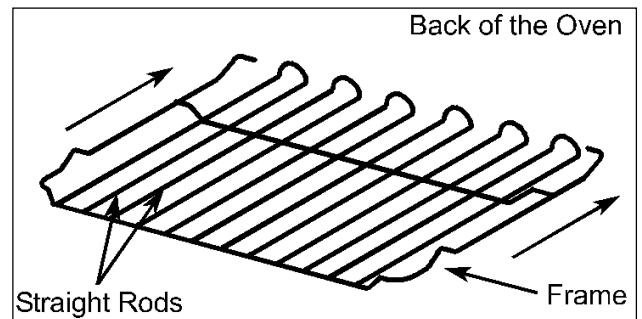

HINTS AND TIPS

- Most cooking should be carried out using an oven shelf positioned in one of the shelf runners.

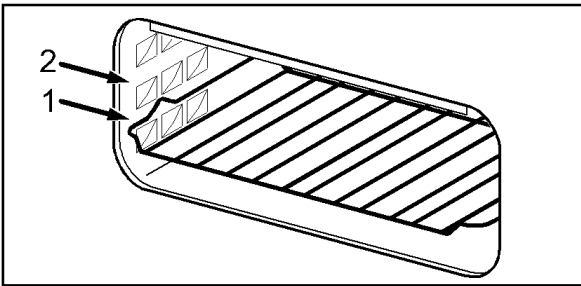

- Larger roasts and casseroles should normally be cooked in the main oven. However, they may be cooked on a flat shelf from the main oven placed on the base of the top oven provided there is sufficient room for air circulation around the food.
- Stand dishes on a suitably sized baking tray on the shelf to prevent spillage onto the oven base and to help reduce cleaning.

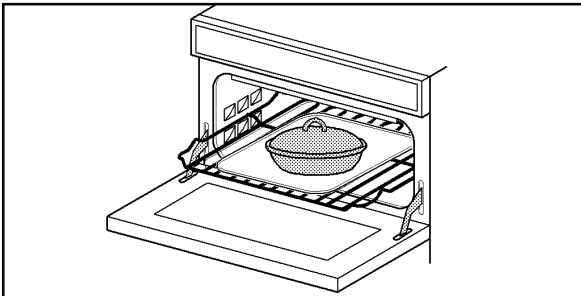

- There should always be at least 2.5cm (1") between the top of the food and the element. This gives best cooking results and allows room for rise in yeast mixtures, Yorkshire puddings, etc.

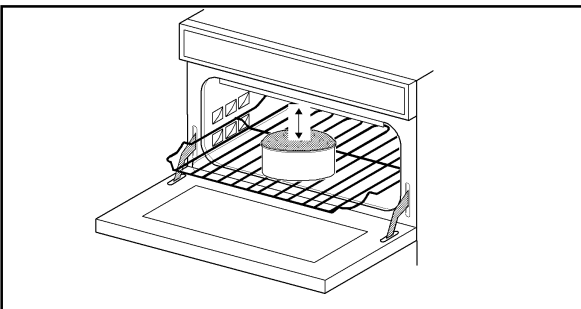

- When cooking cakes, pastry, scones, bread, etc., place the tins or baking trays centrally on the shelf directly below the element.

- DO NOT place dishes directly onto the oven base as it becomes very hot and damage may occur.

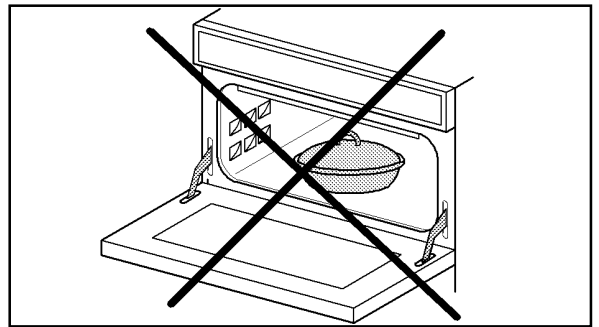

- The material and finish of the baking trays and dishes will affect the degree of base browning of the food. Enamelware, dark, heavy or non-stick utensils increase base browning. Shiny aluminium or polished steel trays reflect the heat away and give less base browning.
- DO NOT use the grill pan as a baking tray as this will increase base browning of the food.
- Because of the smaller cooking space, lower temperatures and shorter cooking times are sometimes required. Be guided by the recommendations on pages 21 and 22.
- For economy leave the door open for the shortest possible time, particularly when placing food into a pre-heated oven.

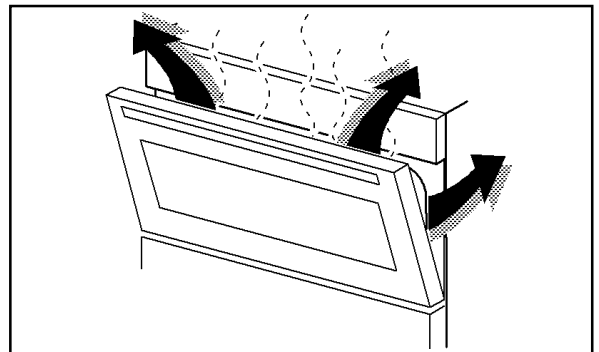

AUTOMATIC COOKING

If you use the automatic timer to cook food in the top oven be guided by the recommendations given below.

- * It is advisable to leave food in the oven for as short a time as possible before automatic cooking.
- * When cooking is complete do not leave food to stand in the oven, but remove and cool it quickly if the food is not to be consumed immediately.
- * Always ensure food in the oven is covered if its not possible to remove food immediately after cooking.

THE MAIN FAN OVEN

USES OF THE FAN OVEN

PREHEATING

The fan oven quickly reaches its temperature, so it is not usually necessary to preheat the oven. Without preheating, however, you may find you need to add an extra 5 - 10 minutes on the recommended cooking times.

For recipes needing high temperatures, e.g. bread, pastries, scones, soufflés, etc., best results are achieved if the oven is preheated first. For best results when cooking frozen or chilled ready meals always preheat the oven first.

COOKING TEMPERATURES

Fan oven cooking generally requires lower temperatures than conventional cooking. Follow the temperatures recommended in the chart on page 21. As a guide reduce temperatures by about 20°C - 25°C for your own recipes. For best results when cooking frozen or cooked chilled ready meals always preheat the oven first.

BATCH BAKING

The fan oven cooks evenly on both shelf levels, especially useful when batch baking.

SELECTING THE FAN OVEN

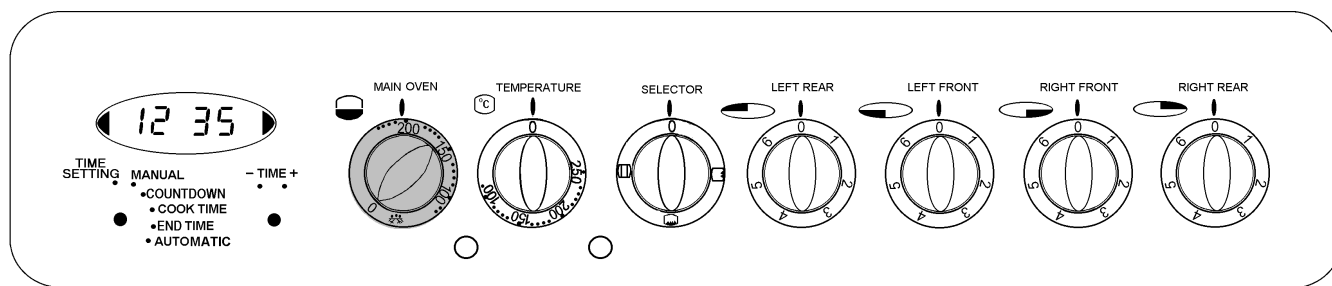

- Turn the main oven temperature control to the required setting.

THINGS TO NOTE

1. The main oven indicator neon will glow until the oven has reached the desired temperature and then go out. It will turn ON and OFF periodically during cooking showing that the temperature is being maintained.
2. The cooling fan for the controls may switch in after a time. See page 9 for more information on the operation of the cooling fan.

TO FIT THE MAIN OVEN SHELVES

The shelves should be fitted with the straight rods uppermost on the frame and the forms towards the back of the oven. If not fitted correctly the anti-tilt and safety stop mechanism will be affected.

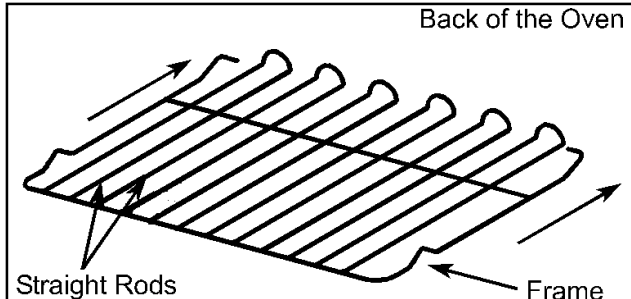

HINTS AND TIPS

- Arrange the shelves in the required positions before switching the oven ON. Shelves are numbered from the bottom upwards.

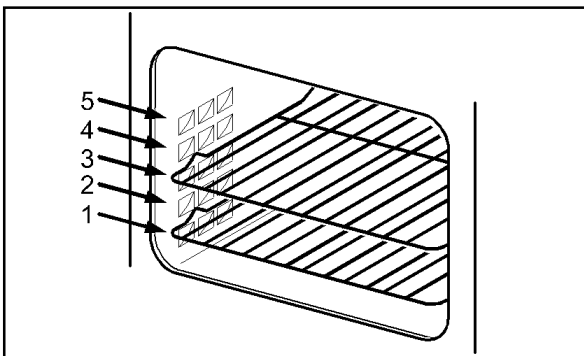

- When cooking more than one dish in the fan oven, place dishes centrally on different shelves rather than cluster several dishes on one shelf. This will allow the heat to circulate freely for the best cooking results.
- When batch baking one type of food, e.g. Victoria sandwich cakes, those of similar size will be cooked in the same time.

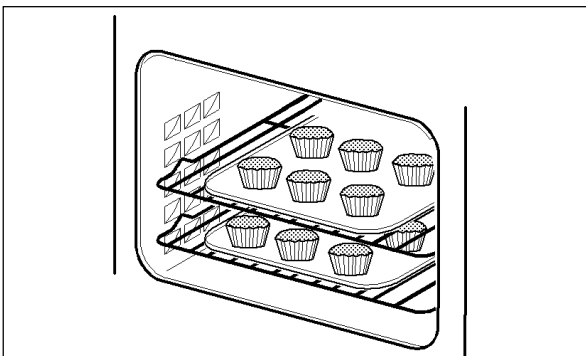

- It is recommended that when baking larger quantities, the shelf positions should be evenly spaced to suit the load being cooked. A slight increase in cooking time may be necessary.

- Do not place dishes or baking trays directly on the oven floor as it interferes with the oven air circulation and can lead to base burning; use the lower shelf position. However non critical dishes can be placed on the oven base when more space is required.

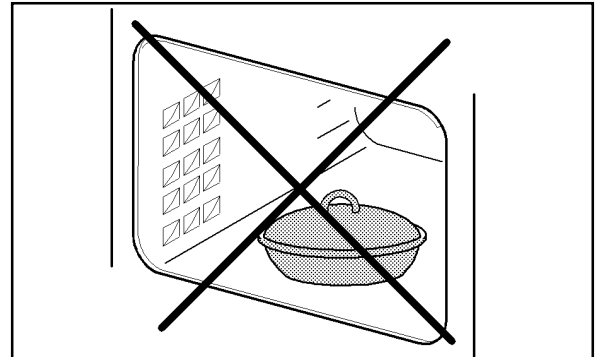

- The use of excessively high temperatures can cause uneven browning. It may be necessary to reduce temperatures slightly. Refer to the recommendations given in the oven cooking charts on pages 21 and 22.
- DO NOT use the cranked shelf from the grill in the main oven.

AUTOMATIC COOKING

If you use the automatic timer to cook food in the main oven be guided by the recommendations below.

- * It is advisable to leave food in the oven for as short a time as possible before automatic cooking.
- * When cooking is complete do not leave food to stand in the oven, but remove and cool it quickly if the food is not to be consumed immediately.
- * Always ensure food in the oven is covered if its not possible to remove food immediately after cooking.

OVEN COOKING CHART

The oven temperatures are intended as a guide only. It may be necessary to increase or decrease the temperatures by 10° C to suit individual preferences and requirements.

FOOD	FAN OVEN		TOP OVEN		
	SHELF POSITION	COOKING TEMP °C	SHELF POSITION	COOKING TEMP °C	APPROX COOK TIME (m)
Biscuits		180-190	1 crk.	170-190	10 - 20
Bread		200-220	1 crk.*	200-220	25 - 30
Bread rolls/buns	Shelf	200-220	1 crk.	200-220	15 - 20
Cakes:					
Small & Queen		160-170	1 crk.	180-190	18 - 25
Sponges		160-170	1 crk.	160-170	18 - 20
Victoria Sandwich	positions	160-170	1 crk.	160-170	18 - 25
Madeira		140-150	1 crk.	140-150	1¼ - 1½h
Rich Fruit		130-140	1 crk.	130-140	2¼ - 2½h
Christmas	are not	130-140	1 crk.	130-140	3 - 4½h
					depends on size
Gingerbread		140-150	1 crk.	140-150	1¼ - 1½h
Meringues	critical	80-100	1 crk.	90-100	2½ - 3h
Flapjack		170-180	1 crk.	170-180	25 - 30
Shortbread		130-140	1 crk.	140-150	45 - 65
Casseroles:					
Beef/lamb	but ensure	140-160	1 crk.*	140-160	2½ - 3h
Chicken		180-190	1 crk.*	180-190	1¼ - 1½h
Convenience Foods		Follow manufacturer's instructions			
Fish	that oven	170-190	1 crk.	170-190	20 - 30
Fish Pie (Potato Topped)		190-200	1 crk.*	190-200	20 - 25
Fruit Pies, Crumbles		190-200	1 crk.	190-200	40 - 50
Milk Puddings	shelves are	130-140	1 crk.	140-150	1½ - 2h
Pasta, Lasagne etc.		190-200	1 crk.	170-180	40 - 45
Pastry:					
Choux		190-200	1 crk.	180-190	30 - 35
Eclairs, Profiteroles	evenly	170-180	1 crk.	170-180	20 - 30
Flaky/Puff Pies		210-220	1 crk.*	210-220	25 - 40
Shortcrust					
Mince Pies		190-200	1 crk.	190-200	15 - 20
Meat Pies	spaced	190-210	1 crk.*	190-210	25 - 35
Quiche, Tarts, Flans		180-210	1 crk.	180-200	25 - 45
Patés and Terrines		150-160	1 crk.	150-160	1-1½h
Roasting Meat, Poultry	when more	160-180	1 crk.*	160-180	see roasting chart
Scones		210-220	1 crk.	220-230	8 - 10
Shepherd's Pie		190-200	1 crk.*	190-200	30 - 40
Soufflés	than one is	170-180	1 crk.	170-180	20 - 30
Vegetables:					
Baked Jacket Potatoes		180-190	1 crk.	180-190	1-1½h
Roast Potatoes		180-190	1 crk.	180-190	1-1½h
Stuffed Marrow	used	180-190	1 crk.	180-190	30 - 35
Stuffed Tomatoes		180-190	1 crk.	180-190	15 - 20
Yorkshire Puddings: Large		210-220	1 crk.	200-210	25 - 40
Individual		200-210	1 crk.	200-210	15 - 25

crk. = cranked shelf

* or on a straight shelf on the oven base

Note: Shelf positions are counted from the bottom of the oven.
Do not use the cranked shelf from the grill in the main oven.

ROASTING CHART

ROASTING CHART		
INTERNAL TEMPERATURES - Rare : 50-60°C; Medium : 60-70°C; Well done:70-80°C		
MEAT	SECOND/FAN OVEN	COOKING TIME
Beef	160-180°C	20-35 min per ½kg/1lb and 20-35 min over
Beef, boned	160-180°C	20-35 min per ½kg/1lb and 25-35 min over
Mutton and Lamb	160-180°C	25-35 min per ½kg/1lb and 25-35 min over
Pork and Veal	160-180°C	30-40 min per ½kg/1lb and 30-40 min over
Ham	160-180°C	30-40 min per ½kg/1lb and 30-40 min over
Chicken	160-180°C	15-20 min per ½kg/1lb and 20 min over
Turkey and Goose	160-180°C	15-20 min per ½kg/1lb up to 3½kg/7lb then 10 min per ½kg/1lb over 3½kg/7lb.
Duck	160-180°C	25-35 min per ½kg/1lb and 25-30 min over
Pheasant	160-180°C	35-40 min per ½kg/1lb and 35-40 min over
Rabbit	160-180°C	20 min per ½kg/1lb and 20 min over
Potatoes with meat	160-180°C	according to size
Potatoes without meat	180-190°C	according to size

The roasting temperatures and times given in the chart should be adequate for most joints, but slight adjustments may be required to allow for personal requirements and the shape and texture of the meat. However, lower temperatures and longer cooking times are recommended for less tender cuts or larger joints.

Wrap joints in foil if preferred, for extra browning uncover for the last 30 - 60 min. cooking time.

DEFROST FEATURE

USES OF DEFROST FEATURE

This fan oven function defrosts most foods faster than more conventional methods. It is particularly suitable for delicate frozen foods which are to be served cold e.g. cream filled gateaux, cakes covered with icings or frostings, cheesecakes, biscuits, scones etc.

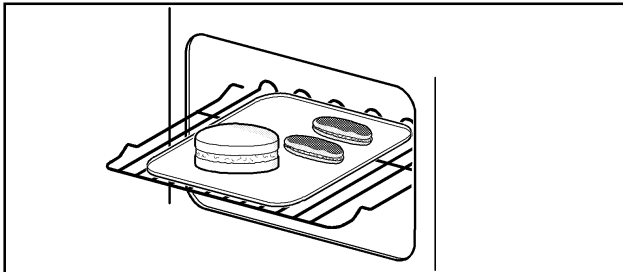

It is preferable to thaw fish, meat and poultry slowly in the fridge. However, this process can be accelerated by using the defrost function.

Small or thin fish fillets, frozen peeled prawns, cubed or minced meat, liver, thin chops, steaks etc., can be thawed in 1 - 2 hours.

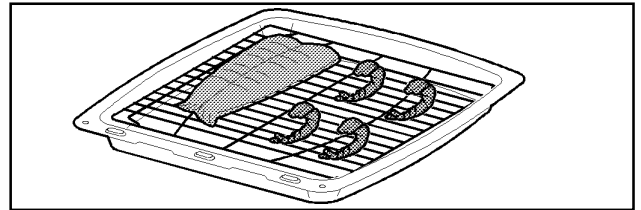

A 1kg/2¼lb oven ready chicken will be thawed in approximately 5 hours. Remove the giblets as soon as possible during the thawing process.

Joints of meat up to 2kg/4½lb in weight can be thawed using the defrost function.

ALL JOINTS OF MEAT AND POULTRY MUST BE THAWED THOROUGHLY BEFORE COOKING.

ALWAYS COOK THOROUGHLY IMMEDIATELY AFTER THAWING.

SELECTING DEFROST

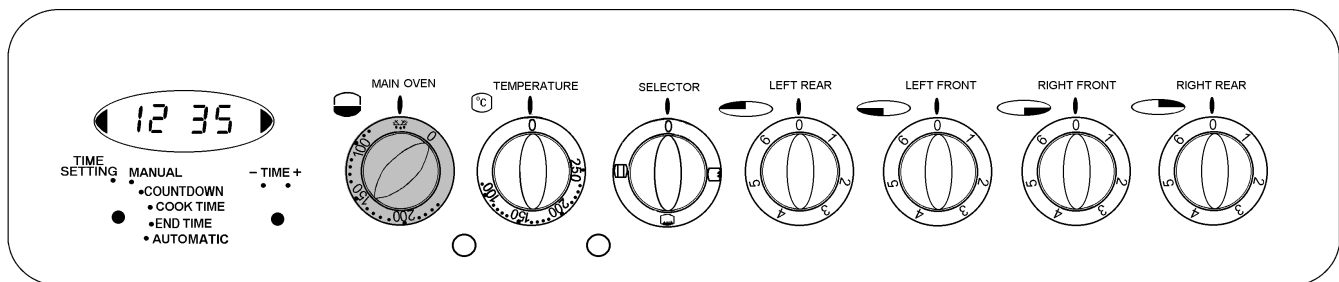

- Turn the main oven temperature control to the defrost setting. 

THINGS TO NOTE

1. When defrost is selected, the oven indicator neon may come ON. It will stay ON until the oven reaches room temperature and then go OFF. It may turn ON and OFF periodically during defrosting to maintain a steady room temperature, inside the oven.
2. Care must always be taken when handling foods in the home. Always follow the basic rules of food hygiene to prevent bacterial and microbial growth and cross contamination when defrosting, preparing, cooking, cooling and freezing foods.

HINTS AND TIPS

- Place the frozen food in a single layer where possible and turn it over half way through the defrosting process.

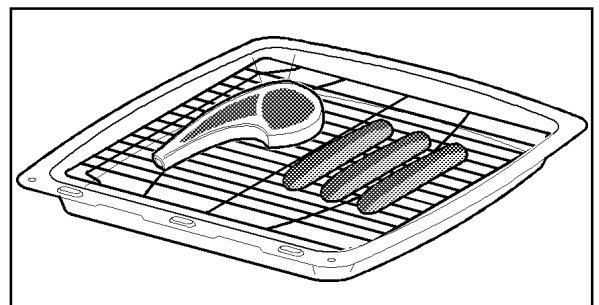

- The actual speed of defrosting is influenced by room temperature. On warm days defrosting will be faster than on cooler days.
- **DO NOT** leave food at room temperature once it is defrosted. Cook raw food immediately or store cooked food in the fridge.

BEFORE CLEANING ALWAYS ALLOW THE COOLING FAN TO COOL THE APPLIANCE DOWN BEFORE SWITCHING OFF AT THE ELECTRICITY SUPPLY.

CLEANING MATERIALS

Before using any cleaning materials on your cooker, check that they are suitable and that their use is recommended by the manufacturer.

Cleaners that contain bleach should NOT be used as they may dull the surface finishes. Harsh abrasives should also be avoided. Multi-surface anti bacterial products should not be used on the surrounding trims.

CLEANING THE BRASS PLATED HANDLES

(Where Applicable)

It is strongly recommended that only hot soapy water is used for cleaning the handles. ANY OTHER CLEANING MATERIALS WILL DULL THE BRASS PLATED FINISH.

CLEANING THE SEALED HOTPLATES AND HOTPLATE TRIMS

In order to maintain the appearance of your cooker's sealed hotplates and trims you are advised to use the recommended cleaning agents daily. If you do not allow spillages to burn on they will be much easier to clean off.

THINGS TO NOTE

The red spot in the centre of the hotplates may be removed with some abrasive cleaning agents. This is not a fault and does not effect the performance of the hotplate.

FOR NORMAL SOILAGE

Wipe over the hotplates and trims using a clean damp cloth then switch to a low or medium setting for a few minutes to thoroughly dry.

FOR HEAVY SOILAGE

Use a clean damp cloth or scourer with a cream cleaner e.g. 'Jif' or a powder cleaner e.g. 'Ajax' on the hotplate and trims. Follow the circular grooved pattern on the hotplate when cleaning. Rinse off cleaning agents thoroughly. Dry as for normal soilage.

For more stubborn marks warm the hotplate on a low setting for 30 seconds. Clean the sealed plate with 'Ajax' powder cleaner, 'Jif' cream cleaner or a Brillo pad. You may have to rub hard for several minutes.

Rinse off cleaning agents thoroughly with a damp cloth. Switch to a low or medium setting for a few minutes until the hotplate is thoroughly dry.

CLEANING THE STAINLESS STEEL HOTPLATE TRIMS

The stainless steel trims may become straw coloured during use. Using a proprietary stainless steel cleaner, e.g. 'Shiny Sinks' will help maintain a bright appearance. Alternatively a powder cleaner such as 'Bar Keepers Friend' may be used regularly.

CLEANING THE VITREOUS ENAMEL

Use a clean damp cloth or scourer made for non-stick saucepans with 'Jif' cream cleaner.

AFTER CLEANING

To maintain the appearance of the hotplates occasionally apply a little salt free vegetable oil or commercial restorative agent.

To apply vegetable oil, first heat the hotplate on a medium setting for 30 seconds then turn OFF. Pour a very small amount of oil onto kitchen paper, apply the paper to the hotplate and wipe off any excess oil. Heat the hotplate on a medium setting for 1 minute.

To apply restorative agent, apply a thin coating of '4 Hob' or use a Minky hotplate cleaning cloth following the manufacturers instructions.

CLEANING THE OUTSIDE OF THE COOKER

DO NOT use abrasive cleaning materials, or scourers on the outside of the cooker as some of the finishes are painted and damage may occur. Regularly wipe over the control panel, oven doors and cooker sides using a soft cloth and liquid detergent.

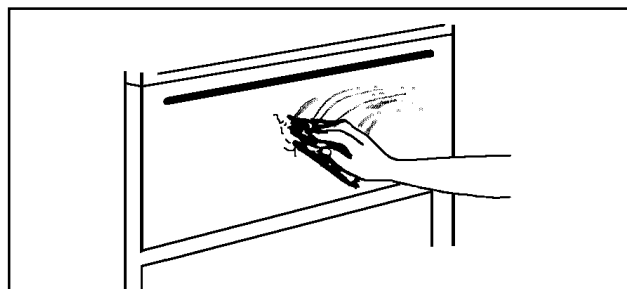

DO NOT ATTEMPT TO REMOVE ANY OF THE CONTROL KNOBS FROM THE PANEL AS THIS MAY CAUSE DAMAGE AND IS A SAFETY HAZARD.

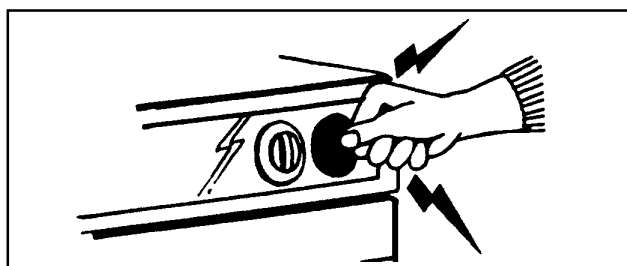

CLEANING THE GRILL DEFLECTOR, GRILL PAN, GRILL PAN GRID AND OVEN SHELVES

All removable parts, except the grill pan handle can be washed in the dishwasher.

The grill pan, grill deflector and oven shelves may be cleaned using a soap impregnated steel wool pad. The grill pan grid should be cleaned using hot soapy water. Soaking first in soapy water will make cleaning easier.

CLEANING INSIDE THE GRILL/OVEN COMPARTMENTS

The sides, top and back of the grill/top oven and main oven are coated with a special Stayclean coating.

The Stayclean coating should not be cleaned manually.

The vitreous enamel fan oven base and grill compartment base, can be cleaned using normal oven cleaners or aerosol oven cleaners with care. Ensure that the manufacturers instructions are followed and that all parts are well rinsed afterwards.

Aerosol cleaners must not be used on Stayclean surfaces and must not come into contact with elements as this may cause damage.

For advice on how to keep the Stayclean coating in good condition see 'Care of Stayclean Surfaces'.

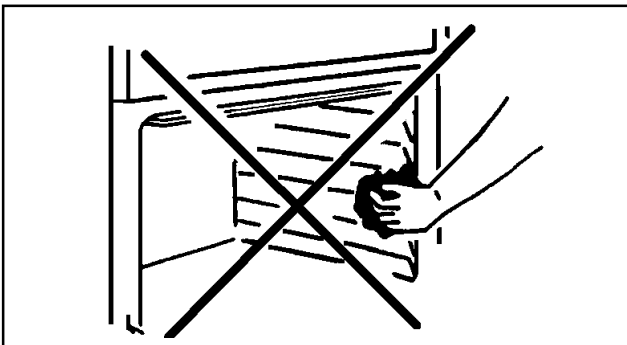

CARE OF STAYCLEAN SURFACES

Stayclean surfaces destroy splashes of food and fats when the oven temperature is raised to around 220°C.

It is a good idea to run the oven for an hour or two per week to ensure continued good performance from the Stayclean finish.

Do use the trivet in the roasting tin. During roasting, the fat from the joint will be contained beneath the trivet and therefore prevent it from splashing onto the Stayclean finish.

HINTS AND TIPS

- Manual cleaning of Stayclean Surfaces IS NOT recommended. Damage will occur if oven sprays or abrasives of any kind are used.
- Slight discolouration and polishing of the Stayclean surface may occur in time. This does not affect the Stayclean properties in any way.
- A good time to allow the oven to run on is after the weekly roast. After removing the roast, turn the oven up to 220°C and allow to run for an hour or so. It is important NOT to allow a build-up of soilage as this can prevent the Stayclean from working.
- Follow the recommendations below to keep oven soilage to a minimum.
- Cook at the recommended temperatures. Higher temperatures during roasting will increase soilage. Try cooking at lower temperatures for an increased length of time, you will save energy and often the joint is more tender.
- Use minimal, if any, extra oil or fat when roasting meat, potatoes only require brushing with fat before cooking. Extra fat in the oven during roasting will increase splashing and soilage.
- It is NOT necessary to add water to the meat tin when roasting. The water and the fat juices from the joint create excessive splattering during cooking - even at normal temperatures, as well as causing condensation.
- Covering joints during cooking will also prevent splashing onto the interior surfaces. Removing the covering for the last 20-30 minutes will allow extra browning if required. Some large joints and turkeys especially benefit by this method of cooking, allowing the joint to cook through before the outside is over-browned.

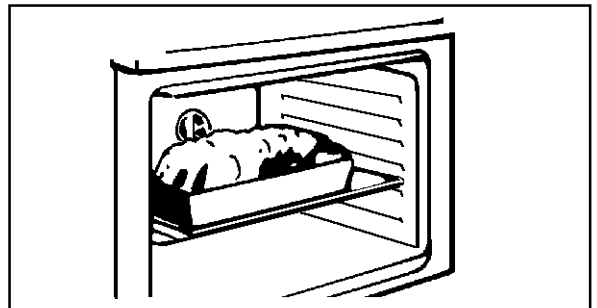

SOMETHING NOT WORKING?

Before calling an Engineer please carry out the following checks, you may be able to solve the problem without the expense of an engineer.

If our Service Engineer finds that the problem is listed below you will be charged for the call whether or not the appliance is under guarantee.

The cooker does not work at all:

- * Check that the appliance has been wired in and is switched on at the wall.
- * Check that the main cooker fuse is working.
- * Check that the timer is set to manual (see page 11).

The grill and hotplates work but the oven does not:

- * Check that the timer is set to manual operation (see page 11).

The oven temperature is too high or low:

- * Check that the recommended temperatures are being used (see page 21). Be prepared to adjust up or down by 10°C to achieve the results you want.

The hotplates and main oven work but the grill does not:

- * Check that you have carefully followed the instructions for operation of the grill.
- * If the cooling fan fails, the grill will not operate.
Please call your Local Service Force Centre.

If the oven is not cooking evenly or the side opening door will not stay open:

- * Check that the cooker is level.

If the oven fan is noisy:

- * Check that the cooker is level.
- * Check that shelves and bakeware are not vibrating in contact with the back panel in the oven.

SERVICE AND SPARE PARTS



In the event of your appliance requiring service, or if you wish to purchase spare parts please contact your local Tricity Bendix Service Force Centre by telephoning:

0870 5 929929

Your call will be routed to the Service Force Centre covering your post code area. The address of your local Service Force Centre is detailed on pages 28 -29.

For Service in the **Republic of Ireland** contact
Tricity Bendix
Long Mile Road
Dublin 12

Telephone: 01 4090752

Before calling out an engineer, please ensure you have read the details under the heading 'Something Not Working'.

When you contact the Service Centre you will need to give the following details:

1. Your name, address and post code
2. Your telephone number
3. Clear and concise details of the fault
4. The model, product and serial number of the appliance (found on the rating plate)
5. The purchase date

CUSTOMER CARE DEPARTMENT

For general enquiries concerning your Tricity Bendix appliance, or further information on Tricity Bendix products, you are invited to contact our Customer Care Department by letter or telephone as follows:

Customer Care Department
Tricity Bendix
55 - 77 High Street
Slough
Berkshire
SL1 1DZ

Tel: 0870 5 950950 *

*calls to this number may be recorded for training purposes.

To contact your local Tricity Bendix Service Centre telephone **0870 5 929929**

CHANNEL ISLANDS

GUERNSEY Guernsey Electricity
PO Box 4
Vale, Guernsey
Channel Islands

JERSEY Jersey Electricity
Company
PO Box 45
Queens Road
St Helier
Jersey
Channel Islands
JE4 8NY

SCOTLAND

ABERDEEN (M05) 54 Claremont Street
Aberdeen
AB10 6RA

AUCHTERMUCHY (M03) 33A Burnside
Auchtermuchy
Fife
KY14 7AJ

BLANTYRE (M07) Unit 5
Block 2
Auchenraith Ind Estate
Rosendale Way
Blantyre
G72 0NJ

DUMFRIES (M01) 93 Irish Street
Dumfries
Scotland
DG1 2PQ

DUNOON (M67) Briar Hill
7 Hill Street,
Dunoon
Argyll
PA23 7AL

GLASGOW (M04) 20 Cunningham Road
Clyde Estate
Rutherglen,
Glasgow,
G73 1PP

INVERNESS (M06) Unit 3B
Smithton Ind. Estate
Smithton
Inverness
IV1 AJ

ISLE OF ARRAN (OWN SALES) Arran Domestics
Unit 4 The Douglas
Centre
Brodict
Isle of Arran
KA27 8AJ

ISLE OF BARRA (OWN SALES) J Zerfah
244 Bruernish
Isle of Barra
Western Islands
HS9 5QY

ISLE OF BUTE (M66) Walker Engineering
Glenmhor
Upper Serpentine Road
Rothsay
Isle of Bute
PA20 9EH

ISLE OF LEWIS (M69) ND Macleod
16 James Street
Stornoway
Isle of Lewis PA87 2QW

KELSO (M08) 2-8 Wood Market
Kelso
Borders TD5 7AX

ORKNEY (M65) Corsie Domestics
7 King Street
Kirkwall
Orkney KW15

PERTH Hydro Electric
Inveralmond House
Ruthvenfield Road
Perth PH1 3AQ

PERTH (OWN SALES) Graham Begg
Unit 4
Airport Ind Estate
Wick KW1 4QS

SHETLAND (OWN SALES) Tait Electronic Systems
Ltd.
Holmsgarth Road
Lerwick
Shetland ZE1 0PW

SHETLAND (OWN SALES) Bolts Shetland Ltd
26 North Road
Lerwick
Shetland ZE1 0PE

WHALSAY (OWN SALES) Leask Electrical
Harlsdale
Symbister, Whalsay
Shetland ZE2 9AA

NORTHERN IRELAND

BELFAST (M27) Owenmore House
Kilwee Business Park
Upper Dunmury Lane
Belfast
BT17 0HD

WALES

CARDIFF (M28) Guardia Industrial Estate
Clydesmuir Road
Tremorfa, Cardiff
CF2 2QS

CLYWD (M14) Unit 6-7 Coed - Parc
Abergele Road
Rhuddlan
Clwyd
Wales
LL18 5UG

DYFED (M77) Maes Y Coed
High Mead
Llanybydder
Camarthenshire
SA40 9UL

HAVERFORDWEST (M75) Cromlech Lodge
Ambleton
Haverfordwest
Pembrokeshire
SA62 5DS

OSWESTRY (M17) Plas Ffynnon
Warehouse
Middleton Road
Oswestry
SY11 2PP

NORTH EAST

GATESHEAD (M39) Unit 356a
Dukesway Court
Dukesway
Team Valley
Gateshead
NE11 0BH

GRIMSBY (M42) 15 Hainton Avenue
Grimsby
South Humberside
DN32 9AS

HULL (M41) Unit 1
Boulevard Industrial
Estate
Hull
HU3 4AY

LEEDS (M37) 64-66 Cross Gates Road
Leeds
LS15 7NN

NEWTON AYCLIFFE (M45) Unit 16
Gurney Way
Aycliffe Industrial Estate
Newton Aycliffe
DL5 6UU

SHEFFIELD (M38) Pennine House
Roman Ridge Ind.
Roman Ridge Road
Sheffield
S9 1GB

NORTH WEST

BIRKENHEAD (M11) 1 Kelvin Park
Dock Road
Birkenhead
L41 1LT

CARLISLE (M10) Unit 7 James Street
Workshops
James Street
Carlisle
Cumbria
CA2 5AH

ISLE OF MAN (M64) South Quay Ind. Estate
Douglas
Isle of Man
IM1 5AT

LIVERPOOL (M15) Unit 1
Honeys Green Precinct
Honeys Green Lane
Liverpool
L12 9JH

MANCHESTER (M09) Unit B Central Industrial
Estate
St Marks Street
Bolton
BL3 6NR

PRESTON (M13) Unit 250
Dawson Place
Walton Summit
Bamber Bridge
Preston
Lancashire
PR5 8AL

STOCKPORT (M16) Unit 20 Haigh Park
Haigh Avenue
Stockport
SK4 1QR

To contact your local Tricity Bendix Service Centre telephone **0870 5 929929**

MIDLANDS

BIRMINGHAM (M18)	66 Birch Road East, Wyrley Road Ind. Estate Witton Birmingham B6 7DB
BOURNE (M44)	Manning Road Ind Estate Pinfold Road Bourne PE10 9HT
BRIDGNORTH (M72)	68 St. Mary's Street Bridgnorth Stropshire WV16 4DR
GLOUCESTER (M23)	101 Rycroft Street Gloucester GL1 4NB
HEREFORD (M31)	Unit 3 Bank Buildings Cattle Market Hereford HE4 9HX
HIGHAM FERRERS (M51)	30 High Street Higham Ferrers Northants NN10 8BB
ILKESTON (M43)	Unit 2 Furnace Road Ilkeston DE7 5EP
LEICESTER (M22)	Unit 7 Oaks Industrial Estate Coventry Road Narborough Leicestershire LE0 5GF
LINCOLN (M40)	Unit 8 Stonefield Park Clifton Street Lincoln LN5 8AA
NEWCASTLE LYME (M12)	18-21 Croft Road Brampton Ind. Estate Newcastle under Lyme Staffordshire ST5 0TW
REDDITCH (M20)	13 Thornhill Road North Moons Moat Redditch Worcestershire B98 9ND
TAMWORTH (M19)	Unit 3 Sterling Park Claymore Tamworth B77 5DO
WORCESTER (M73)	Unit 1&2 Northbrook Close Gregorys Mill Ind. Estate Worcester WR3 8BP

LONDON & EAST ANGLIA

BECKENHAM (M79)	11a Gardener Ind. Estate Kent House Lane Beckenham Kent BR3 1QZ
CHELMSFORD (M47)	Hanbury Road Widford Ind Estate Chelmsford Essex CM12 3AE
COLINDALE (M53)	Unit 14 Capitol Park Capitol Way Colindale London NW9 0EQ
ELTHAM (M78)	194 Court Road Mottingham Eltham London SE9 4EW
ENFIELD (M49)	284 Alma Road Enfield London EN3 7BB
GRAVESEND (M57)	Unit B4, Imperial Business Estate Gravesend Kent DA11 0DL
HARPENDEN (M46)	Unit 4 Riverside Estate Coldharbour Lane Harpenden AL5 4UN
LETCHEWORTH (M50)	16-17 Woodside Ind Est. Works Road Letchworth Herts SG6 1LA
LONDON (M76)	2/4 Royal Lane Yiewsley West Drayton Middlesex UB7 8DL
MAIDENHEAD (M60)	Reform Road Maidenhead Berkshire SL6 8BY
MOLESEY (M61)	10 Island Farm Avenue West Molesey Surrey KT8 2UZ
NEWBURY (M24)	9 Pipers Court Berkshire Drive Thatcham Berkshire RG19 4ER
IPSWICH (M48)	Unit 6C EltonParkBusines Centre Hadleigh Road Ipswich IP2 0DD
NORWICH (M52)	2b Trafalgar Street Norwich NR1 3HN
SUNBURY (M63)	Unit 1a The Summit Hanworth Road Hanworth Ind Estate Sunbury on Thames TW16 5D

SOUTH EAST

ASHFORD (M58)	Unit 2 BridgeRoadBusinessEst Bridge Road Ashford Kent TN2 1BB
FLEET (M59)	Unit 1 Redfields Ind. Estate Church Crookham Fleet Hampshire GU13 0RD
HAYWARDS HEATH (M55)	21-25 Bridge Road Haywards Heath Sussex RH16 1UA

SOUTH WEST

BARNSTAPLE (M30)	Main Road Fremington Barnstaple North Devon EX31 2NT
BOURNEMOUTH (M26)	63-65 Curzon Road Bournemouth Dorset BH1 4PW
BRIDGEWATER (M35)	6 Hamp Ind. Estate Bridgewater Somerset TA6 3NT
BRISTOL (M25)	11 Eldon Way Eldonwall Trading Bristol Avon BS4 3QQ
EMSWORTH (M33)	266 Main Road Southbourne Emsworth PO10 8JL
ISLE OF WIGHT (M34)	Unit 8 Enterprise Court Ryde Business Park Ryde Isle of Wight PO33 1DB
NEWTON ABBOT (M29)	Unit 2 Zealley Ind. Estate Kingsteignton Newton Abbot S. Devon TQ12 3TD
REDRUTH (M36)	Unit 7D Pool Ind. Estate Wilson Way Redruth Cornwall TR15 3QW

GUARANTEE CONDITIONS

Standard guarantee conditions

We, Tricity Bendix, undertake that if within 12 months of the date of the purchase this Tricity Bendix appliance or any part thereof is proved to be defective by reason only of faulty workmanship or materials, we will, at our option repair or replace the same FREE OF CHARGE for labour, materials or carriage on condition that:

- The appliance has been correctly installed and used only on the electricity supply stated on the rating plate.
- The appliance has been used for normal domestic purposes only, and in accordance with the manufacturer's instructions.
- The appliance has not been serviced, maintained, repaired, taken apart or tampered with by any person not authorised by us.
- All service work under this guarantee must be undertaken by a Tricity Bendix service centre.
- Any appliance or defective part replaced shall become the Company's property.
- This guarantee is in addition to your statutory and other legal rights.

Home visits are made between **8.30am** and **5.30pm** Monday to Friday. Visits may be available outside these hours in which case a **premium** will be charged.

Exclusions

This guarantee does not cover:

- Damage or calls resulting from transportation, improper use or neglect, the replacement of any light bulbs or removable parts of glass or plastic.
- Costs incurred for calls to put right an appliance which is improperly installed or calls to appliances outside the United Kingdom.
- Appliances found to be in use within a commercial environment, plus those which are subject to rental agreements.
- Products of Tricity Bendix manufacture which are not marketed by Tricity Bendix.

European Guarantee

If you should move to another country within Europe then your guarantee moves with you to your new home subject to the following qualifications:

- The guarantee starts from the date you first purchased your product.
- The guarantee is for the same period and to the same extent for labour and parts as exists in the new country of use for this brand or range of products.
- This guarantee relates to you and cannot be transferred to another user.
- Your new home is within the European Community (EC) or European Free Trade Area.
- The product is installed and used in accordance with our instructions and is only used domestically, i.e. a normal household.
- The product is installed taking into account regulations in your new country.

Before you move please contact your nearest Customer Care centre, listed below, to give them details of your new home. They will then ensure that the local Service Organisation is aware of your move and able to look after you and your appliances.

France	Senlis	+33 (0)3 44 62 28 28
Germany	Nürnberg	+49 (0)911 323 2600
Italy	Pordenone	+39 (0)1678 47053
Sweden	Stockholm	+46 (0)20 78 77 50
UK	Slough	+44 (0)1753 219898

RATING PLATE REFERENCE

MAKE AND MODEL NO.	PRODUCT NO.	SERIAL NO.	DATE OF PURCHASE

IMPORTANT NOTICE

In line with our continuing policy of research and development, we reserve the right to alter models and specifications without prior notice.

This handbook is accurate at the date of printing, but will be superseded and should be disregarded if specifications or appearance are changed.



TRICITY BENDIX, 55 - 77 HIGH STREET, SLOUGH, BERKSHIRE, SL1 1DZ
TELEPHONE 0870 5 950950

MODEL NO.
SIE 400

PART NO.
311479508



© Electrolux Household Appliances Limited 2000

 **From the Electrolux Group.** *The world's No. 1 choice.*

The Electrolux Group is the world's largest producer of powered appliances for kitchen, cleaning and outdoor use. More than 55 million Electrolux group products (such as refrigerators, cookers, washing machines, vacuum cleaners, chain saws and lawn mowers) are sold each year to a value of approx. USD 14 billion in more than 150 countries around the world.

Download from [Www.Somanuals.com](http://www.Somanuals.com). All Manuals Search And Download.

Free Manuals Download Website

<http://myh66.com>

<http://usermanuals.us>

<http://www.somanuals.com>

<http://www.4manuals.cc>

<http://www.manual-lib.com>

<http://www.404manual.com>

<http://www.luxmanual.com>

<http://aubethermostatmanual.com>

Golf course search by state

<http://golfingnear.com>

Email search by domain

<http://emailbydomain.com>

Auto manuals search

<http://auto.somanuals.com>

TV manuals search

<http://tv.somanuals.com>