

# INSTRUCTION BOOK

FOR TRICITY BENDIX  
COOKER HOOD  
**TBH 630**

Thank you for buying a Tricity Bendix product.

To enable you to use your appliance effectively and safely, please read this instruction book carefully before using the appliance and retain for future reference. If you require guidance in the use of the appliance or require further information on Tricity Bendix Products, please contact our Customer Care Department.

Customer Care Department  
Tricity Bendix  
55-77 High Street  
Slough  
Berkshire  
SL1 1DZ

Tel: 08705 950950  
Fax: 01753 538972

**To register ownership, please ensure you complete and return the guarantee card supplied with the appliance.**

## For the User

### Important Safety Information

### Your Appliance

### Operating Instructions

The Controls  
To Operate  
Extraction  
Recirculation

### Maintenance and Cleaning

External Cleaning  
Synthetic Paper Grease Filter  
To Replace the Synthetic Paper Grease Filter  
Charcoal Filters (Optional Extra)  
To Remove/Replace the Charcoal Filter  
Changing the Light Bulb

### Something Not Working

### Service and Spare Parts

### Guarantee Conditions

## For the Installer

### Installation Instructions

Technical Information

### Electrical Connections

Electrical Requirements  
Electrical Connection

### Installing the Cooker Hood

Installation Requirements  
Ducting  
Clearance Height  
Unpacking  
Wall Fitting  
Venting  
To Fit the Ducting  
Recirculation  
Fitting the Cooker Hood to the Wall

### Service Force Centres

**To register ownership, please ensure you complete and return the guarantee card supplied with the appliance.**

## Guide to use the instruction book

The following Symbols will be found in the text to guide you through the instruction book



Safety instructions



Step by step instructions

# IMPORTANT SAFETY INFORMATION

These warnings are provided in the interests of your safety. Ensure that you understand them all before installing or using this appliance. Your safety is of paramount importance. If you are unsure about any of the meanings of these warnings contact the Customer Care Department.

## ■ Installation

- Any installation work must be undertaken by a qualified electrician or a competent person.
- This hood must be installed in accordance with the installation instructions and all measurements must be adhered to.
- If the cooker hood is installed for use above a gas appliance then the provision for ventilation must be in accordance with the Gas Safety Codes of Practice BS.6172, BS.5440 and BS.6891 (Natural Gas) and BS.5482 (LP Gas) 1994, the Gas Safety (Installation & Use) Regulations, the Building Regulations issued by the Department of the Environment, the Building standards (Scotland) (Consolidated) Regulations issued by the Scottish Development Department.
- The fan motor of this cooker hood incorporates a cut-out device which will operate if the cooker hood is installed below the minimum height recommended under section 'Clearance Height', or if the motor becomes overheated. If the cut-out device is activated, switch off the fan motor and allow the cooker hood to cool. The cut-out device will reset itself when the fan motor has cooled significantly.
- It is dangerous to alter the specifications or modify this product in any way.
- When installed between adjoining wall cabinets the wall cabinets must not overhang the hob.
- If the room where the hood is to be used contains a fuel burning appliance such as a central heating boiler then its flue must be of the room sealed or balanced flue type.
- If other types of flue or appliances are fitted ensure that there is an adequate supply of air to the room.
- The ducting system for this appliance must not be connected to any existing ventilation system which is being used for any other purpose.

- Do not install above a cooker with a high level grill.

## ■ Child Safety

- This appliance is designed to be operated by adults. Children should not be allowed to tamper with the controls or play with the appliance.

## ■ During Use

- This product is for domestic use only.
- Never leave frying pans unattended during use as over-heated fats and oils might catch fire.
- Never do flambé cooking under this cooker hood.
- Do not leave naked flames under the hood.

## ■ Maintenance and Service

- This appliance can be a hazard if the synthetic paper and charcoal filters are not replaced as recommended.
- Under no circumstances should you attempt to repair the appliance yourself. Repairs carried out by inexperienced persons may cause injury or more serious malfunction. Refer to your local Tricity Bendix Service Centre. Always insist on genuine spare parts.

## YOUR APPLIANCE

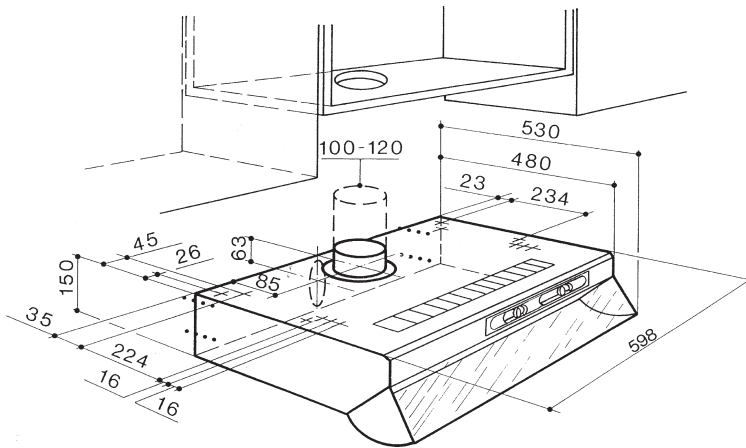

## OPERATING INSTRUCTIONS

This cooker hood is designed to extract unpleasant odours from the kitchen, it will not extract steam.

To obtain the best performance it is advisable to switch on the hood a few minutes before you start cooking and leave it running for approximately 15 minutes after finishing.

The cooker hood controls are located on the right hand side, in the front fascia panel.

### The Controls

Fan ON/OFF/Speed Control

- Position 0 - Off
- Position 1 - Low
- Position 2 - Normal
- Position 3 - Boost

Light ON/OFF control

- 0 - Off
- 1 - On

### To Operate

Select the required fan speed and light if required.

## Extraction

The contaminated air enters the hood passing through the grease filter and out through the ducting into the atmosphere.

## Recirculation

In the recirculation mode contaminated air is passed through the charcoal filter (**optional extra**) to be purified and recirculated into the kitchen through a recirculation grille.



*When the ducting position is selected the charcoal filter is not required.*

*Never do flambé cooking under this cooker hood.*

*Take extra care when frying and never leave frying pans unattended during use as overheated fats and oils might catch fire.*

*Do not leave naked flames under the cooker hood.*

*Ensure heating areas on your hob are covered with pots and pans when using the hob and cooker hood simultaneously.*

## MAINTENANCE AND CLEANING

 Before carrying out any maintenance or cleaning isolate the cooker hood from the mains supply.

*The cooker hood must be kept clean, a build up of grease or fat can be a fire hazard.*

### External Cleaning

Wipe the cooker hood frequently with warm soapy water using a mild detergent.

 Always wear protective gloves when cleaning the hood.

*Never use scouring pads or abrasive cleaners.*

*Never use excessive amounts of water when cleaning particularly around the control panel.*

### Synthetic Paper Grease Filter

This filter cannot be washed and must be replaced at least every 2 months.

 The synthetic paper grease filter cannot be cleaned.

**It must not be washed.**

### To Replace the Synthetic Paper Grease Filter

1. Open the glass visor.
2. Press inwardly on the two slide catches as illustrated in (A) and the grille will open from the front.
3. Slide the right edge of the grille forward until it clears the guide and then unhook the left hinge pin.
4. Carefully ease out the metal wire retaining clips as illustrated in (B).
5. Clean the metal grille and clips before replacing the filter.

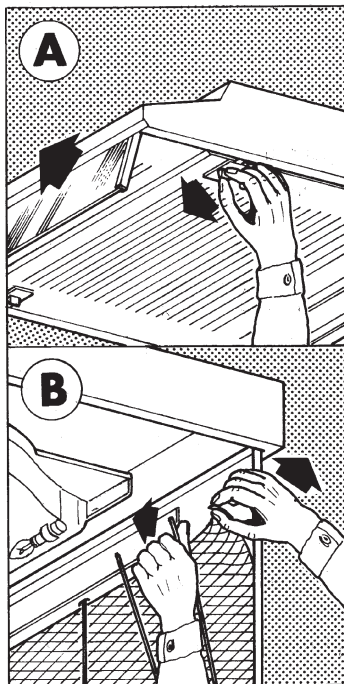

 Handle the wire clips with care and keep away from children as they have sharp points.

## Charcoal Filter (Optional Extra)

The charcoal filter cannot be cleaned.

The filter should be replaced at least every three months or more frequently if the hood is used more than three hours per day.

### To Remove/Replace the Charcoal Filter

1. Remove the metal inlet grille.
2. Carefully twist the plastic disc anticlockwise, while holding the charcoal filter securely.
3. Clean the metal inlet grille and motor support before replacing the charcoal filter.

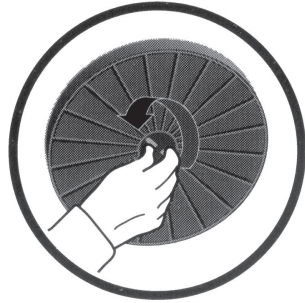

## Changing the Light Bulb

If a lamp fails to function check that the bulb is screwed into the holder.

If bulb failure has occurred then it should be replaced with a 220-240V 40W clear cylindrical shape bulb with a small E14 screw thread.

**Charcoal filters, grease filters and light bulbs can be obtained from your local Service Centre.**



*This appliance can be a fire hazard if the grease and charcoal filters are not cleaned and replaced as recommended.*

## SOMETHING NOT WORKING

Symptom	Solution
<b>The cooker hood will not start</b>	<ul style="list-style-type: none"> <li>• Check the hood is connected to the electricity supply.</li> <li>• Make sure the switch is in the 'ON' position.</li> </ul>
<b>The cooker hood is not working effectively</b>	<ul style="list-style-type: none"> <li>• The fan speed is set high enough for the task</li> <li>• The grease filter is clean.</li> <li>• The kitchen is adequately vented to allow the entry of fresh air.</li> <li>• If set up for recirculation, check that the charcoal filter is still effective.</li> <li>• If set up for extraction, check that the ducting and outlets are not blocked.</li> </ul>
<b>The cooker hood has switched off during operation</b>	<ul style="list-style-type: none"> <li>• The safety cut-out device has been tripped.</li> <li>• Turn off the hob and then wait for the device to reset.</li> </ul>

If after all these checks, the fault persists, contact your local Tricity Bendix Service Centre, quoting the model and serial number.

Please note that it will be necessary to provide proof of purchase for any in-guarantee service calls.

**In-guarantee customers should ensure that the above checks have been made as the engineer will make a charge if the fault is not a mechanical or electrical breakdown.**

## SERVICE AND SPARE PARTS

If you require an engineer or spare parts contact your local Service Centre by telephoning:

**08705 929929**

Your telephone call will be routed to your local Tricity Bendix Service Centre. The addresses are listed in the back of the book.

For general assistance with your appliance or for further information on Tricity Bendix products please contact our Customer Care Department.

Customer Care Department,  
Tricity Bendix  
55-77 High Street  
Slough  
Berkshire SL1 1DZ

Telephone: 08705 950 950 \*

\* calls to this number may be recorded for training purposes.



## GUARANTEE CONDITIONS

We, Tricity Bendix, undertake that if within twelve months of the date of the purchase this Tricity Bendix built-in appliance or any part thereof is proved to be defective by reason only of faulty workmanship or materials, the company will, at our option repair or replace the same **FREE OF ANY CHARGE** for labour, materials or carriage on condition that:

- The appliance has been correctly installed and used only on the electrical supply stated on the rating plate.
- The appliance has been used for normal domestic purposes only, and in accordance with the manufacturer's operating and maintenance instructions.
- The appliance has not been serviced, maintained, repaired, taken apart or tampered with by any person not authorised by us.
- All service work under this guarantee must be undertaken by Tricity Bendix Service Centres.
- Any appliance or defective part replaced shall become the property of this company.

Home visits are made between **8.30am and 5.30pm Monday to Friday**. Visits may be available outside these hours in which case a premium will be charged.

### EXCLUSIONS

**This Guarantee does not cover:**

- Damage or calls resulting from transportation, improper use or neglect, the replacement of any light bulbs or removable parts of glass or plastic.
- Costs incurred for calls to put right appliances improperly installed or calls to appliances outside the United Kingdom.
- Appliances found to be in use within a commercial environment, plus those which are the subject of rental agreements.
- Products of Tricity Bendix manufacture which are not marked by Tricity Bendix.

This guarantee is in addition to your statutory and legal rights.

### TRICITY BENDIX EUROPEAN GUARANTEE

If you should move to another country within Europe then your guarantee moves with you to your new home subject to the following qualifications:

- The guarantee starts from the date you first purchased your product.
- The guarantee is for the same period and to the same extent for labour and parts as exists in the new country of use for this brand or range of products.
- This guarantee relates to you and cannot be transferred to another user.
- Your new home is within the European Community (EC) or European Free Trade Area.
- The product is installed and used in accordance with our instructions and is only used domestically, i.e. a normal household.

**Before you move please contact your nearest Customer Care Centre, listed below, to give them details of your new home. They will then ensure that the local Service Organisation is aware of your move and able to look after you and your appliances.**

France	Senlis	+33 (0)3 44 62 22 22
Germany	Nurnberg	+49 (0)911 323 2600
Italy	Pordenone	+39 (0)1678 47053
Sweden	Stockholm	+46 (0)20 78 77 50
UK	Slough	+44 (0)1753 219898

# INSTALLATION INSTRUCTIONS



*It is dangerous to alter the specifications or attempt to modify this product in any way.*

## Technical Information

### DIMENSIONS

HEIGHT:	15cm
WIDTH:	60cm
DEPTH:	48cm
DEPTH WITH VISOR OPEN:	53cm

### WEIGHT

GROSS:	7,00kg
NET:	6,00kg

### ELECTRICAL SUPPLY:

Voltage (50Hz) 220-240 V

### POWER CONSUMPTION:

115W

### FAN MOTOR:

75W

### LAMP:

40W

### SUITABLE FOR INSTALLATION

#### ABOVE:

ELECTRIC HOB:	7KW (max)
GAS HOB:	10KW (max)
SLOT-IN GAS COOKER	13.5KW (max)
SLOT-IN ELECTRIC COOKER	12.4KW (max)



**Note: CE Marking certifies that this appliance complies with the requirements laid down in EEC directive 89:336. (Electromagnetic compatibility) and subsequent modifications and Low Voltage directive 72/23/E.**

# ELECTRICAL CONNECTIONS



**WARNING: DOUBLE INSULATED-DO NOT EARTH**

## Electrical Requirements

Any permanent electrical installation must comply with the latest I.E.E. Regulations and local Electricity Board regulations. For your own safety this should be undertaken by a qualified electrician e.g. your local Electricity Board, or a contractor who is on the roll of the National Inspection Council for Electrical Installation Contracting (NICEIC).

## Electrical Connection

Before connecting to the mains supply ensure that the mains voltage corresponds to the voltage on the rating plate inside the cooker hood.

This appliance is fitted with a 2 core mains cable and must be permanently connected to the electricity supply via a double-pole switch having 3mm minimum contact gap on each pole. A Switched Fuse Connection Unit to BS.1363 Part 4, fitted with a 3 A fuse is a recommended mains supply connection accessory to ensure compliance with the Safety Requirements applicable to fixed wiring instructions.

This appliance conforms to BS.800: 1988 and EEC Directive No. 78 308 regarding suppression of radio and television interference.

# INSTALLING THE COOKER HOOD

**Please ensure that when the appliance is installed it is easily accessible to an engineer in the event of a breakdown.**



*All installations must comply with the local authorities requirements for the discharge of exhaust air.*

*Incorrect installation may affect the safety of this cooker hood.*

## Installation Requirements



*Before installation check the wall to which the cooker hood is to be fitted for electric cables, water pipes or gas.*

If it is necessary to fix the hood to a hollow construction plaster or partition board structure then it should be sufficiently reinforced to be quite rigid in the area of the cooker hood keyhole fixing screws, and the appropriate rawl plugs used for this type of fixing (not supplied).

## Ducting

The ducting must be fire retardant 100mm (4ins) in diameter and the length should be no more than:

3 metres with one 90° bend

2 metres with two 90° bends

Bends of more than 90° will reduce the efficiency of the hood and reduce the airflow.

## Clearance Height

The cooker hood is designed to be fitted over a cooking appliance at the clearance heights stated, providing the maximum output of the appliance beneath does not exceed the maximums quoted in the Technical Specifications.

If the output of the appliance below the cooker exceeds the maximum output quoted, please refer to the cooker manufacturer's installation instructions.

## Clearance Height

A minimum clearance height of 650mm (25 1/2 ") is required when installed above a built-in electric hob, or 700mm (27 1/2 ") when installed above a built-in gas hob.

A minimum clearance height of 685mm (27") is required when installed above a slot-in electric oven, or 787mm (30 1/2 ") when installed above a slot-in gas oven.

When installed between adjoining wall cabinets, the wall cabinets must not overhang the hob and the distance between the underside of the cabinet and the worktop must be 420mm. If the height of the wall cabinet is less than 420mm a gap of 50mm must be maintained either side of the hob.

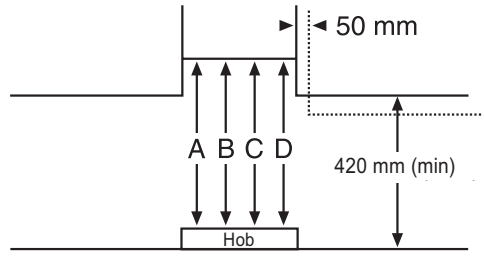

- A: Built-in Electric Hob: 650mm minimum clearance  
B: Built-in Gas hob: 700mm minimum clearance  
C: Slot-in Electric Cooker: 685mm minimum clearance  
D: Slot-in Gas Cooker: 787mm minimum clearance



*This cooker hood must not be installed above a cooking appliance with a high level grill.*

## Unpacking

The fittings supplied to install this cooker hood can be found with the instruction book inside the packaging and consists of the following:

- Wall/suspended fixing template
- Ducting spigot 100mm (4")

## Wall Fitting

The cooker hood is fitted to the wall using the keyhole slots in the back of the hood.

1. Mark the position on the wall for the two 8mm dia screw holes (A) as illustrated in the drawing opposite at 568mm.
2. Check that the hole distances are correct and are level using a spirit level.
3. At this stage it is important to allow 25mm (1") clear space above the cooker hood to enable it to be hooked onto the screws and for subsequent removal for decorating or servicing.
4. Insert the screws and tighten to a distance of 5mm.

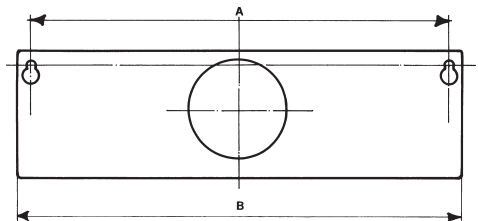

## Venting

The hood is more effective when used in the extraction setting (ducted to the outside).

Venting kits may be purchased through your retailer or DIY store, and must be ducted to an outside vent of 100mm (4") minimum.

 *The ducting used must be manufactured from fire retardant material which should conform to the relevant British Standard or DIN4102-B1.*

When the hood is ducted externally the charcoal filter must be removed and the slider control must be in the ducting position.

## To Fit the Ducting

1. Fit the ducting spigot and blanking plate, by aligning the interlocking lugs on the fittings, with the recesses in the aperture as illustrated in (A) and (B) opposite.
2. Insert and turn anti-clockwise to lock the spigot and blanking plate into position.

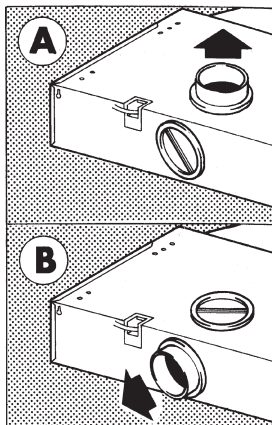

## Recirculation

The charcoal filter (**optional extra**) must be fitted for recirculation and the slider control must be in the recirculation position.

## Fitting the Cooker Hood to the Wall

1. Remove the grille by pressing inwardly on the two slide catches.
2. Hinge the grille forward to free it from the guides in the side of the casing. The two keyhole slots are now visible.
3. Hook the hood onto the screws (not supplied) using the keyhole slots.
4. Tighten the screws to secure the hood to the wall. **Ensure the cooker hood is correctly located before letting go.**
5. Refit the grille onto the cooker hood
  - insert the left hand hinge pin into the hole in the left hand side of the casing.
  - slide the right hand hinge pin into the guide over the stop position.
  - close the grille and secure using the two slide catch bolts.

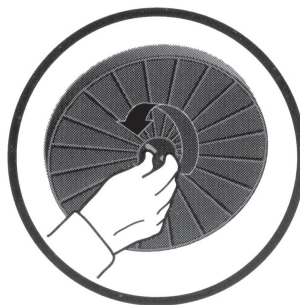
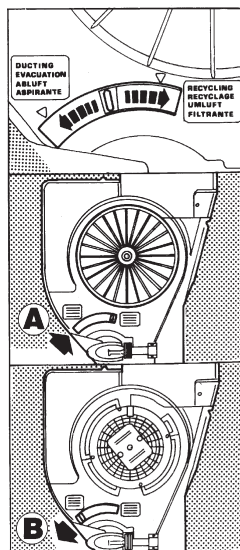

# SERVICE FORCE

To contact your local Service Force Centre telephone **08705 929 929**

<p style="text-align: center;"><b>CHANNEL ISLANDS</b></p> <p>GUERNSEY      <b>Guernsey Electricity</b> PO Box 4 Vale, Guernsey Channel Islands GY1 3AD</p> <p>JERSEY          <b>Jersey Electricity Company</b> Haut De L'orme Rue De Haut De L'orme Trinity Jersey Channel Islands JE3 5FG</p>	<p>ISLE OF LEWIS      <b>ND Macleod</b> 16 James Street Stornoway Isle of Lewis PA87 2QW</p> <p>KELSO                <b>2, 6 &amp; 8 Woodmarket</b> Kelso Borders TD5 7AX</p> <p>ORKNEY              <b>7 King Street</b> Kirkwall Orkney KW15 1JF</p>	<p style="text-align: center;"><b>NORTH EAST</b></p> <p>GATESHEAD        <b>Unit 356a</b> Dukesway Court Dukesway Gateshead NE11 0BH</p> <p>GRIMSBY            <b>15 Hainton Avenue</b> Grimsby N. E. Lincs DN32 9AS</p> <p>HULL                 <b>Unit 1</b> Boulevard Industrial Estate Hull HU3 4AY</p> <p>LEEDS                <b>64-66 Cross Gates Road</b> Cross Gates Leeds LS15 7YS</p> <p>NEWTON AYCLIFFE <b>Unit 23</b> Northfield Way Aycliffe Industrial Park Newton Aycliffe DL5 6EJ</p> <p>SHEFFIELD         <b>Pennine House</b> Roman Ridge Road Sheffield S9 1GB</p>
<p style="text-align: center;"><b>SCOTLAND</b></p> <p>ABERDEEN         <b>54 Claremont Street</b> Aberdeen AB10 6RA</p> <p>AUCHTERMUCHTY   <b>33a Burnside</b> Auchtermuchty Fife KY14 7AJ</p> <p>BLANTYRE          <b>Unit 5</b> Block 2 Auchenraith Ind. Estate Rosendale Way Blantyre G72 0NJ</p> <p>DUMFRIES          <b>93 Irish Street</b> Dumfries DG1 2 PQ</p> <p>DUNOON             <b>7 Hill Street</b> Dunoon Argyll PA23 7AL</p>	<p>PERTH                <b>Scottish Hydro Electric</b> Central Warehouse Inveralmond Perth PH1 3AF</p> <p>(OWN SALES)</p> <p>SHETLAND          <b>3-4 Carlton Place</b> Lerwick Shetland ZE1 0PW</p> <p>(OWN SALES)</p> <p>SHETLAND          <b>Bolts Shetland</b> 26 North Road Lerwick Shetland ZE1 0PE</p> <p>(OWN SALES)</p> <p>WHALSAY          <b>Leask Electrical</b> Harisdale Symbister, Whalsay Shetland ZE2 9AA</p> <p>(OWN SALES)</p>	<p style="text-align: center;"><b>NORTH WEST</b></p> <p>BIRKENHEAD        <b>1 Kelvin Park</b> Dock Road Birkenhead CH41 1LT</p> <p>CARLISLE           <b>Unit 7</b> James Street Workshops James Street Carlisle Cumbria CA2 5AH</p> <p>ISLE OF MAN        <b>South Quay Ind. Estate</b> Douglas Isle of Man IM1 5AT</p> <p>BOLTON              <b>Unit B</b> Central Industrial Estate St Marks Street Bolton BL3 6NR</p> <p>PRESTON            <b>Unit 250</b> Dawson Place Bamber Bridge Preston Lancashire PR5 8AL</p> <p>STOCKPORT         <b>Unit 20 Haigh Park</b> Haigh Avenue Stockport SK4 1QR</p>
<p>EDINBURGH        <b>Unit 12</b> Dumbyrdn Ind. Estate 2 Dumbyrdn Road Edinburgh EH14 2AB</p> <p>GLASGOW          <b>Unit 4</b> Wellington Road Bishopriggs Glasgow G64 2SA</p> <p>INVERNESS         <b>Unit 3BI</b> Smithton Ind. Estate Smithton Inverness IV2 7WL</p> <p>ISLE OF ARRAN     <b>R Haggerty</b> Bruach Blackwaterfoot Isle of Arran</p> <p>ISLE OF BARRA     <b>J Zerfah</b> 244 Bruernish Isle of Barra Western Islands HS9 5QY</p> <p>ISLES OF BUTE     <b>Walker Engineering</b> Glenmhor Upper Serpentine Road Rothesay Isle of Bute PA20 9EH</p>	<p style="text-align: center;"><b>NORTHERN IRELAND</b></p> <p>BELFAST            <b>Owenmore House</b> Kilwee Business Park Dunmurry Belfast BT17 0HD</p>	<p style="text-align: center;"><b>WALES</b></p> <p>CARDIFF            <b>Unit 4</b> Guardian Industrial Estate Clydesmuir Road Cardiff CF2 2QS</p> <p>CLYWD              <b>Unit 6-7 Coed Parc</b> Abergele Road Rhuddlan Clwyd LL18 5UG</p> <p>DYFED               <b>Unit 9</b> St. Clears Business Park Tenby Road St. Clears Carmarthen SA33 4JW</p> <p>OSWESTRY          <b>Plas Ffynnon Warehouse</b> Middleton Road Oswestry SY11 2PP</p>

# SERVICE FORCE

To contact your local Service Force Centre telephone **08705 929 929**

MIDLANDS		LONDON & EAST ANGLIA		SOUTH EAST	
BIRMINGHAM	66 Birch Road East Wyrley Trading Estate Witton Birmingham B6 7DB	BECKENHAM	11a Gardner Ind. Estate Kent House Lane Beckenham Kent BR3 1QZ	ASHFORD	Unit 2 Bridge Road Business Cent Bridge Road Ashford Kent TN23 1BB
BOURNE	Pinfold Road Bourne PE10 9HT	CHELMSFORD	Hanbury Road Widford Ind. Estate Chelmsford Essex CM12 3AE	FLEET	Unit 1 Redfields Ind. Estate Church Crookham Fleet Hampshire GU13 0RD
BRIDGNORTH	68 St. Mary's Street Bridgnorth Shropshire WV16 4DR	COLINDALE	Unit 14 Capitol Park Capitol Way Colindale London NW9 0EQ	HAYWARDS HEATH	21-25 Bridge Road Haywards Heath Sussex RH16 1UA
GLOUCESTER	101 Rycroft Street Gloucester GL1 4NB	ELTHAM	194 Court Road Mottingham Eltham London SE9 4EW	TONBRIDGE	Unit 30 Deacon Trading Estate Morley Road Tonbridge TN9 1RA
HEREFORD	Units 3 & 4 Bank Buildings Cattle market Hereford HE4 9HX	ENFIELD	284 Alma Road Enfield London EN3 7BB		
HIGHAM FERRERS	30 High Street Higham Ferrers Northants NN10 8PL	GRAVESEND	Unit B4 Imperial Business Estate West Mill Gravesend Kent DA11 0DL		
ILKESTON	Unit 2 Furnace Road Ilkeston DE7 5EP	IPSWICH	Unit 6C Elton Park Business Centre Hadleigh Road Ipswich IP2 0DD		
LEICESTER	Unit 7 Oaks Industrial Estate Coventry Road Narborough Leicestershire LE9 5GF	LETCHWORTH	16-17 Woodside Ind. Park Works Road Letchworth Herts SG6 1LA		
LINCOLN	Unit 8 Clifton Street Stone Field Park Lincoln LN5 8LQ	LONDON	2 - 4 Royal Lane Yiewsley West Drayton Middlesex UB7 8DL		
NEWCASTLE UNDER LYME	18-21 Croft Road Brampton Ind. Estate Newcastle under Lyme Staffordshire ST5 0TW	MAIDENHEAD	Reform Road Maidenhead Berkshire SL6 8BY		
REDDITCH	13 Thornhill Road North Moons Moat Redditch Worcestershire B98 9ND	MOLESEY	10 Island Farm Avenue West Molesey Surrey KT8 2UZ		
TAMWORTH	Unit 3 Sterling Park Claymore Tamworth B77 5DQ	NEWBURY	9 Pipers Court Berkshire Drive Thatcham Berkshire RG19 4ER		
WORCESTER	Units 1 & 2 Northbrooks Close Gregorys Mill Ind. Estate Worcester WR3 8BP	NORWICH	2b Trafalgar Street Norwich NR1 3HN		
		SUNBURY	Unit 1a The Summit Hanworth Road Sunbury on Thames TW16 5DB		
					<b>SOUTH WEST</b>
				BARNSTAPLE	Main Road Fremington Barnstaple North Devon EX31 2NT
				BOURNEMOUTH	63-65 Curzon Road Bournemouth Dorset BH1 4PW
				BRIDGEWATER	6 Herswell Business Park Salmon Parade Bridgwater Somerset TA6 5PY
				BRISTOL	11 Eldon Way Eldonwall Trading Estate Bristol BS4 3QQ
				EMSWORTH	266 Main Road Southbourne Emsworth PO10 8JL
				ISLE OF WIGHT	Unit 8 Enterprise Court Ryde Business Park Ryde Isle of Wight PO33 1DB
				NEWTON ABBOT	Unit 2 Zealley Ind. Estate Kingsteignton Newton Abbot TQ12 3TD
				REDRUTH	Unit 7D Pool Ind. Estate Druids Road Redruth Cornwall TR15 3RH



Dir. 89/336/CEE  
73/23/CEE



55-77 High Street - Slough  
BERKSHIRE SL1 1DZ

© Electrolux Household Appliances Limited 2000



## Free Manuals Download Website

<http://myh66.com>

<http://usermanuals.us>

<http://www.somanuals.com>

<http://www.4manuals.cc>

<http://www.manual-lib.com>

<http://www.404manual.com>

<http://www.luxmanual.com>

<http://aubethermostatmanual.com>

Golf course search by state

<http://golfingnear.com>

Email search by domain

<http://emailbydomain.com>

Auto manuals search

<http://auto.somanuals.com>

TV manuals search

<http://tv.somanuals.com>