



1111 W. 35th Street Chicago, IL 60609
Tel: (773) 869-1111 • Fax: (773) 869-1329
FaxBack: (773) 869-1877 • www.tripplite.com

SmartRackSM
Network Enclosure

SR13

Cable Management Kit

1. Place a clip-nut in an appropriate position on the enclosure mounting angle.
2. Attach the bracket #4 to a mounting angle using screw #3 and spacer #2.
3. Thread the hook & loop strip #5 through the bracket #4.

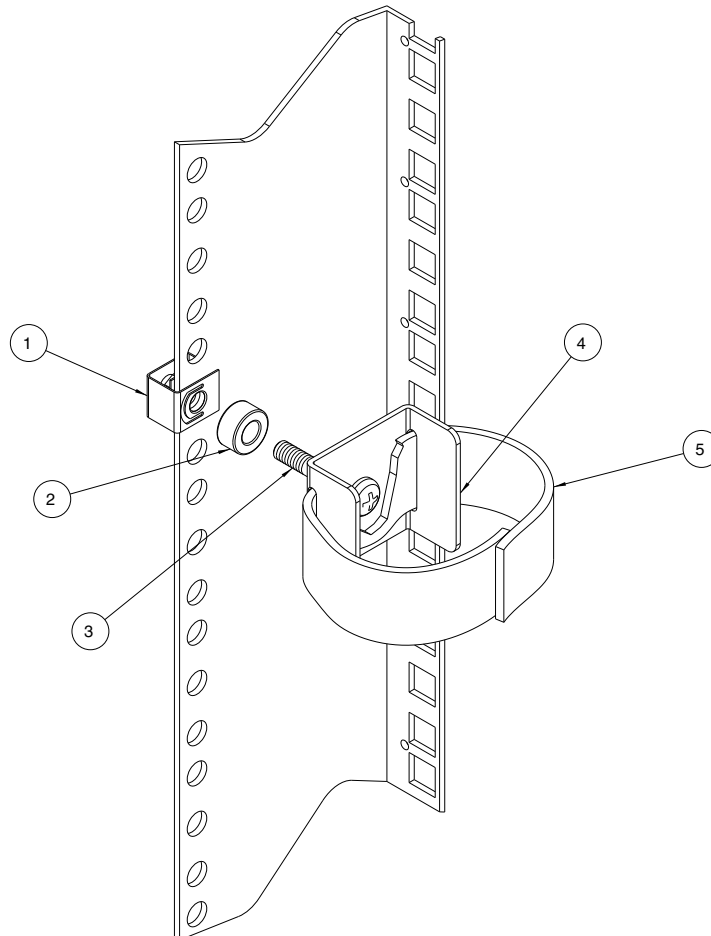



1111 W. 35th Street Chicago, IL 60609
 Tel: (773) 869-1111 • Fax: (773) 869-1329
 FaxBack: (773) 869-1877 • www.tripplite.com

SR13

Required Tools:

Phillips drive screwdriver

Fasteners That Are Required:

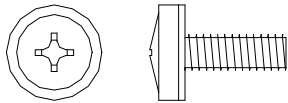

#10-32 x 5/8" Phillips
 Pan Head Screw w/Nylon Washer

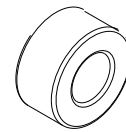

black nylon spacer

Parts List		
Item	Description	Qty.
1	10-32 x 5/8 screw	6
2	Nylon Spacer	6
3	10-32 Clip-Nut	6
4	Bracket	6
5	Hook & loop strip	6

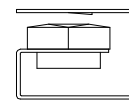
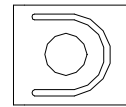

#10-32 Clip Nut

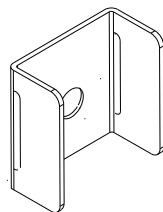

Bracket

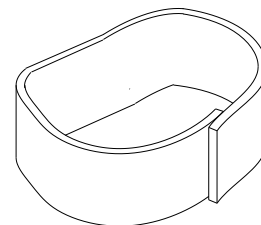

Hook & loop strip

Free Manuals Download Website

<http://myh66.com>

<http://usermanuals.us>

<http://www.somanuals.com>

<http://www.4manuals.cc>

<http://www.manual-lib.com>

<http://www.404manual.com>

<http://www.luxmanual.com>

<http://aubethermostatmanual.com>

Golf course search by state

<http://golfingnear.com>

Email search by domain

<http://emailbydomain.com>

Auto manuals search

<http://auto.somanuals.com>

TV manuals search

<http://tv.somanuals.com>