

**WARRANTY
REGISTRATION**
Register online today for
a chance to win a FREE Tripp Lite
product! www.tripplite.com/warranty



Owner's Manual

PowerVerter® APS Series DC-to-AC Inverter/Charger



	Input	Output
Invert:	12 VDC	120V, 60 Hz. AC
Charge:	120V, 60 Hz. AC	12 VDC



1111 W. 35th Street, Chicago, IL 60609 USA
Customer Support: (773) 869-1234
www.tripplite.com

Reliable Emergency Backup Power

Congratulations! You've purchased the most advanced, feature-rich Inverter/Charger designed as an alternative energy source during utility power failures. Tripp Lite APS Inverter/Chargers keep your equipment up and productive through all utility power problems (blackouts, brownouts and overvoltages) by inverting DC power from user-supplied batteries into AC power. When utility power is present, APS Inverter/Chargers automatically pass through power to your equipment while simultaneously recharging your connected battery bank. Built-in surge suppression provides an additional level of equipment protection. APS Inverter/Chargers are the quiet alternative to gas generators for emergency backup applications. You get AC electricity anywhere and anytime you need it—with no fumes, fuel or noise!

Better for Your Equipment

Premium Protection Levels

- Built-In **ISOBAR**® Surge Protection
- Automatic Overload Protection

Ideal Output for All Loads

- Frequency-Controlled Output
- Automatic Load Switching
- Balanced Load Sharing

Better for Your Batteries

Faster Battery Recharge

- High-Amp, 3-Stage Battery Charger (adjustable)

Critical Battery Protection

- Battery Charge Conserver (Load Sense)
- Battery Temperature Sensing
- High-Efficiency DC-to-AC Inversion

Better for You

Quiet, Simple, Maintenance-Free Operation

- Multi-Function Lights & Switches
- Moisture-Resistant Construction*

Contents

Safety	2	Battery Connection	10
Feature Identification	3	AC Input/Output Connection	11
Operation	4-5	Service/Maintenance	11
Configuration	5-7	Troubleshooting	12
Battery Selection	8	Warranty/Warranty Registration	12
Mounting	9	Español	13

* Inverter/Chargers are moisture-resistant, not waterproof.

Copyright © 2007. All rights reserved. PowerVerter® and Isobar® are registered trademarks of Tripp Lite.

Download from Www.Somanuals.com. All Manuals Search And Download.



SAVE THESE INSTRUCTIONS!

This manual contains important instructions and warnings that should be followed during the installation, operation and storage of this product.

Location Warnings

- Install your Inverter/Charger in a location or compartment that minimizes exposure to heat, dust, direct sunlight and moisture.
- Although your Inverter/Charger is moisture resistant, it is NOT waterproof. Flooding the unit with water will cause it to short circuit and could cause personal injury due to electric shock. Never immerse the unit, and avoid any area where standing water might accumulate. Mounting should be in the driest location available.
- Leave a minimum of 2" clearance at front and back of the Inverter/Charger for proper ventilation. To avoid automatic Inverter/Charger shutdown due to overtemperature, any compartment that contains the Inverter/Charger must be properly ventilated with adequate outside air flow. The heavier the load of connected equipment, the more heat will be generated by the unit.
- Do not install the Inverter/Charger directly near magnetic storage media, as this may result in data corruption.
- Do not install near flammable materials, fuel or chemicals.

Do not mount unit with its front or rear panel facing down (at any angle). Mounting in this manner will seriously inhibit the unit's internal cooling, eventually causing product damage not covered under warranty.

Battery Connection Warnings

- The Inverter/Charger will not operate (with or without utility power) until batteries are connected.
- Multiple battery systems must be comprised of batteries of identical voltage, age, amp-hour capacity and type.
- Because explosive hydrogen gas can accumulate near batteries if they are not kept well ventilated, your batteries should not be installed (whether for a mobile or stationary application) in a "dead air" compartment. Ideally, any compartment would have some ventilation to outside air.
- Sparks may result during final battery connection. Always observe proper polarity as batteries are connected.
- Do not allow objects to contact the two DC input terminals. Do not short or bridge these terminals together. Serious personal injury or property damage could result.

Equipment Connection Warnings

Use of this equipment in life support applications where failure of this equipment can reasonably be expected to cause the failure of the life support equipment or to significantly affect its safety or effectiveness is not recommended. Do not use this equipment in the presence of a flammable anesthetic mixture with air, oxygen or nitrous oxide.

- Only connect your Inverter/Charger to a properly grounded AC power outlet or hardwire power source. Do not plug the unit into itself; this will damage the device and void your warranty.
- You may experience uneven performance if you connect a surge suppressor, line conditioner or UPS system to the output of your Inverter/Charger.

Operation Warnings

- Your Inverter/Charger does not require routine maintenance. Do not open the device for any reason. There are no user serviceable parts inside.
- Potentially lethal voltages exist within the Inverter/Charger as long as the battery supply and/or AC input are connected. During any service work, the battery supply and AC input connection (if any) should therefore be disconnected.
- Do not connect or disconnect batteries while the Inverter/Charger is operating in either inverting or charging mode. Operating Mode Switch should be in the DC OFF position. Dangerous arcing may result.



Caution: Your Inverter/Charger has a failsafe AC pass-through feature. The AC output will be live (if AC input is available) even though the operating mode switch is set to DC OFF.

Feature Identification

Identify the premium features on your specific model and quickly locate instructions on how to maximize their use.

- 1 Configuration DIP Switches:** optimize Inverter/Charger operation depending on your application. See Configuration section for setting instructions.
- 2 Operating Mode Switch:** controls Inverter/Charger operation. The "AUTO/REMOTE" setting ensures your equipment receives constant, uninterrupted AC power. It also enables the Inverter/Charger to be remotely monitored and controlled with an optional remote module (Tripp Lite model APSRM4, sold separately). The "CHARGE ONLY" setting allows your batteries to return to full charge faster by turning the inverter off which halts battery discharging. Setting the Operating Mode Switch to the "DC OFF" (center) position will de-energize the unit and connect "AC OUT" to "AC IN." See Operation section for setting instructions.
- 3 "LINE", "INVERT", "LOAD" LEDs:** intuitive "traffic light" signals show whether the Inverter/Charger is operating from AC line power or DC battery power. It also warns you if the connected equipment load is too high. See Operation section for instructions on reading the indicator lights.
- 4 "BATT VOLTAGE" LEDs:** these three lights will turn on in several sequences to show approximate battery level. See Operation section for instructions on reading the indicator lights.
- 5 DC Power Terminals:** connect to your battery terminals. See Battery Connection section for instructions.
- 6 Hardwire AC Input/Output Terminals:** securely connect the Inverter/Charger to vehicle or facility electrical system input and output. See AC Input/Output Connection section for instructions.
- 7 Resettable Circuit Breakers:** protect your Inverter/Charger against damage due to overload or charger failure. See Operation section for resetting instructions.
- 8 Remote Control Module Connector:** allows remote monitoring and control with an optional module (Tripp Lite model APSRM4, sold separately). See remote module owner's manual for connection instructions.
- 9 Battery Charge Conserver (Load Sense) Dial:** conserves battery power by setting the low-load level at which the Inverter/Charger's inverter automatically shuts off. See Configuration section for setting instructions.
- 10 Main Ground Lug:** properly grounds the Inverter/Charger to vehicle grounding system or to earth ground. See Battery Connection section for instructions.
- 11 Multi-Speed Cooling Fan:** quiet, efficient fan prolongs equipment service life.
- 12 Hardwire AC Input/Output Cover Plate**
- 13 Battery Temperature Sensing Connector (side mounted, not shown):** prolongs battery life by adjusting charge based on battery temperature. Use with included cable. See Configuration section for details.
- 14 DC Power Terminal Cover Plate**

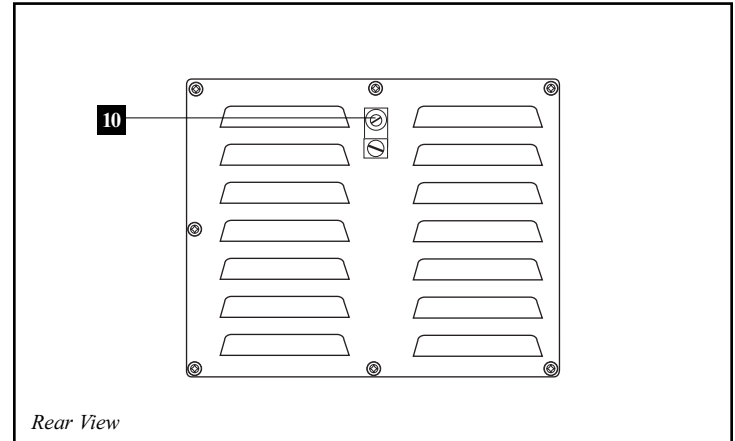
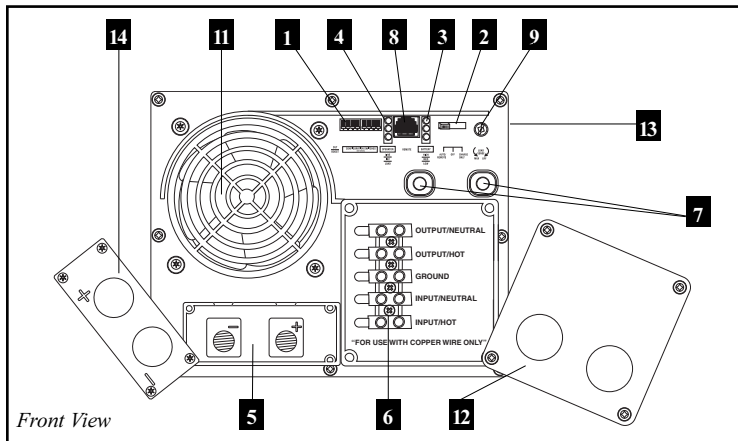

Operation

Switch Modes

After configuring, mounting and connecting your Inverter/Charger, you are able to operate it by switching between the following operating modes as appropriate to your situation:

AUTO/REMOTE: Switch to this mode when you need constant, uninterrupted AC power for connected appliances and equipment. The Inverter/Charger will continue to supply AC power to connected equipment and to charge your connected batteries while utility- or generator-supplied AC power is present. Since the inverter is ON (but in Standby) in this mode, it will automatically switch to your battery system to supply AC power to connected equipment in the absence of a utility/generator source or in over/under voltage situations. "AUTO/REMOTE" also enables an optional remote control module (Tripp Lite model APSRM4, sold separately) to function when connected to the unit.

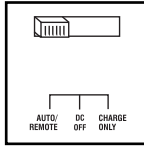

CHARGE ONLY: Switch to this mode when you are not using connected appliances and equipment in order to conserve battery power by disabling the inverter. The Inverter/Charger will continue to supply AC power to connected equipment and charge connected batteries while utility- or generator-supplied AC power is present. However, since the inverter is OFF in this mode, it WILL NOT supply AC power to connected equipment in the absence of a utility/generator source or in over/under voltage situations.

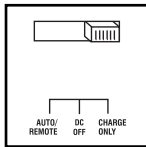

DC OFF: Switch to this mode to shut down the Inverter/Charger, preventing the inverter from drawing power from the batteries, and preventing utility AC from charging the batteries. The "DC OFF" position connects AC OUT to AC IN, providing failsafe pass-through power. Use this switch to automatically reset the unit if it shuts down due to overload or overheating. First remove the excessive load or allow the unit to sufficiently cool (applicable to your situation). Switch to "DC OFF", then back to "AUTO/REMOTE" or "CHARGE ONLY" as desired. If unit fails to reset, remove more load or allow unit to cool further and try again. Use an optional remote control module (Tripp Lite Model APSRM4, sold separately) to reset unit after shutdown due to due to overload or overheating.

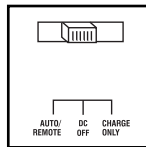

Caution: Your Inverter/Charger has a failsafe AC pass-through feature. The AC output will be live (if AC input is available) even though the operating mode switch is set to DC OFF.

Indicator Lights

Your Inverter/Charger (as well as an optional Tripp Lite Remote Control Module, sold separately) is equipped with a simple, intuitive, user-friendly set of indicator lights. These easily-remembered "traffic light" signals will allow you, shortly after first use, to tell at a glance a wide variety of operating details.

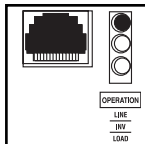

"LINE Green LED": If the operating mode switch is set to "AUTO/REMOTE", this light will ILLUMINATE CONTINUOUSLY when your connected equipment is receiving continuous AC power supplied from a utility/generator source.

If the operating mode switch is set to "CHARGE ONLY", this light will BLINK to alert you that the unit's inverter is OFF and will NOT supply AC power in the absence of a utility/generator source or in over/under voltage situations.

"INV" (Inverting) Yellow LED: This light will ILLUMINATE CONTINUOUSLY whenever connected equipment is receiving battery-supplied, inverted AC power (in the absence of a utility/generator source or in over/under voltage situations). This light will be off when AC power is supplying the load. This light will BLINK to alert you if the load is less than the Battery Charge Converter (Load Sense) setting.

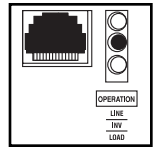

"LOAD" Red LED: This red light will ILLUMINATE CONTINUOUSLY whenever the inverter is functioning and the power demanded by connected appliances and equipment exceeds 100% of load capacity. The light will BLINK to alert you when the inverter shuts down due to a severe overload or overheating. If this happens, turn the operating mode switch "OFF"; remove the overload and let the unit cool. You may then turn the operating mode switch to either "AUTO/REMOTE" or "CHARGE ONLY" after it has adequately cooled. This light will be off when AC power is supplying the load.

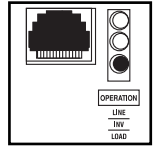

"BATT VOLTAGE" LEDs: If the operating mode switch is in the "AUTO/REMOTE" or "Charge Only" position, the LEDs indicate the approximate charge level and voltage of your connected battery bank and alert you to several fault conditions. See Chart for charge and voltage levels.

LED Function with Switch in "AUTO/REMOTE" or "CHARGE ONLY" Position

Approximate Battery Charge Level*

LEDs Illuminated	Battery Capacity (Charging/Discharging)
1 Green	91%–Full
2 Green & Yellow	81%–90%
3 Yellow	61%–80%
4 Yellow & Red	41%–60%
5 Red	21%–40%
6 All three lights off	1%–20%
7 Flashing red	0% (Inverter shutdown)**

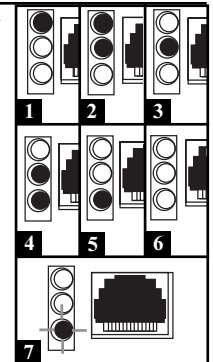

* Charge levels listed are approximate. Actual conditions vary depending on battery condition and load. ** Inverter shutdown protects battery against damage due to excessive discharge.

Fault Condition

LEDs Illuminated	Fault Condition
1 All three lights flash slowly*	Excessive discharge (Inverter shutdown)
2 All three lights flash quickly**	Overcharge (Charger shutdown)

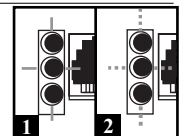

* Approximately 1/2 second on, 1/2 second off. See Troubleshooting section. Inverter shutdown protects battery against damage due to excessive discharge. ** Approximately 1/4 second on, 1/4 second off. Charger shutdown protects battery against damage due to overcharge. May also indicate a battery charger fault exists. See Troubleshooting section.

Resetting Your Inverter/Charger to Restore AC Power

Your Inverter/Charger may cease supplying AC power or DC charging power in order to protect itself from overload or to protect your electrical system. To restore normal functioning:

Overload Reset: Switch operating mode switch to “DC OFF” and remove some of the connected electrical load (ie: turn off some of the AC devices drawing power which may have caused the overload of the unit). Wait one minute, then switch operating mode switch back to either “AUTO/REMOTE” or “CHARGE ONLY.”

Output Circuit Breaker Reset: Alternatively, check output circuit breaker on the unit's front panel. If tripped, remove a portion of the electrical load, wait one minute to allow components to cool, then reset the circuit breaker. See the Troubleshooting section for additional possible reasons why AC output may be absent.

Configuration

Set Configuration DIP Switches

Using a small tool, set the Configuration DIP Switches (located on the front panel, see diagram) to optimize Inverter/Charger operation depending on your application.

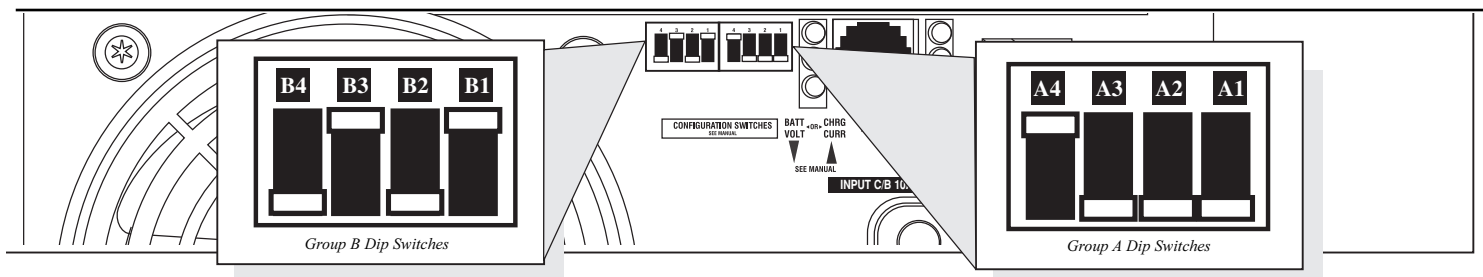

Group A DIP Switches

Using a small tool, configure your Inverter/Charger by setting the four Group A DIP Switches (located on the front panel of your unit; see diagram) as follows:

A1 Select Battery Type—REQUIRED

CAUTION: The Battery Type DIP Switch setting must match the type of batteries you connect, or your batteries may be degraded or damaged over an extended period of time. See “Battery Selection,” for more information.

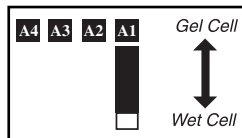

Battery Type	Switch Position
Gel Cell (Sealed) Battery	Up
Wet Cell (Vented) Battery	Down (factory setting)

A2 Charger Inhibit

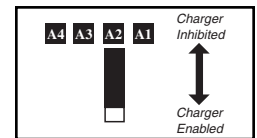

Function	Switch Position
Charger Inhibited	Up
Charger Enabled	Down (factory setting)

A4 A3 Select Low AC Input Voltage Point for Switching to Battery—OPTIONAL*

Voltage	Switch Position
105V	#A4 Up & #A3 Up
95V	#A4 Up & #A3 Down
85V	#A4 Down & #A3 Up
75V	#A4 Down & #A3 Down (factory setting)

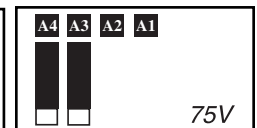
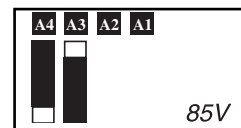
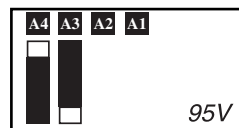
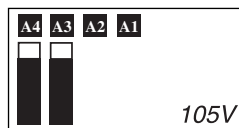

* Most of your connected appliances and equipment will perform adequately when your Inverter/Charger's Low AC Voltage Input Point (DIP Switches #3 and #4 of Group A are set to 95V. However, if the unit frequently switches to battery power due to momentary low line voltage swings that would have little effect on equipment operation, you may wish to adjust these settings. By decreasing the Low AC Voltage Point, you will reduce the number of times your unit switches to battery due to voltage swings.

Group B DIP Switches

B2 B1 Select AC Sharing—OPTIONAL

Your Inverter/Charger features a high-output battery charger that can draw a significant amount of AC power from your utility source or generator when charging at its maximum rate. If your unit is supplying its full AC power rating to its connected heavy electrical loads at the same time as this high charging occurs, the AC input circuit breaker could trip, resulting in the complete shut off of pass-through utility power.

To reduce the chance of tripping this breaker, all APS Inverter/Chargers may be set to automatically limit the charger output. This keeps the sum of the unit's AC load and charge power within the circuit breaker rating. This charger-limiting function has two settings, allowing you to reduce the charger's draw lower and lower, as needed, if the AC input circuit breaker keeps tripping under the normal AC loads of devices you have connected downline from the unit. The figures show how to set your DIP Switches for charger-limiting.

Select Battery Charger-Limiting Points—OPTIONAL

“Most Limiting” (#B2 & #B1 Up): Charger-limiting takes effect the moment any 120V AC load is applied; charger output falls gradually from full output at no 120V load passing through to no output at full load.

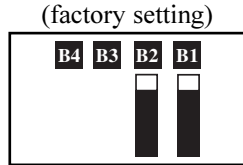

“Less Limiting” (#B2 Up & #B1 Down): Charger-limiting begins when the Inverter/Charger's load reaches 33% of the Inverter/Charger's load rating. Charger output falls gradually from full output at 33% of the Inverter/Charger's load rating to about 40% of full output at full load.

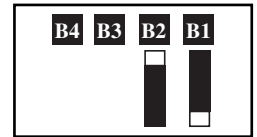

B3 Select Equalize Battery Charge—OPTIONAL

This DIP Switch is momentarily engaged to begin the process of equalizing the charge state of your battery's cells by time-limited overcharge of all cells. This can extend the useful life of certain types of batteries; consult with your battery's manufacturer to determine if your batteries could benefit from this process. The charge equalization process is automatic; once started, it can only be stopped by removing the input power.



Setting Procedure

- Move to “Equalize” (DOWN) position for three seconds.
- Move to “Reset” (UP) position and leave it there. This is the factory default setting.

CAUTION: Do not leave DIP switch #B3 in the down position after beginning process. Battery charge equalization should only be performed in strict accordance with the battery manufacturer's instructions and specifications.

Battery Charge	Switch Position
Reset	Up (factory setting)
Equalize	Down—momentarily

B4 Set Battery Charging Amps—OPTIONAL

Check the nameplate for your unit's high- and low-charging amp options. By setting on high charging, your batteries will charge at maximum speed. When setting on low charging, you lengthen the life of your batteries (especially smaller ones).

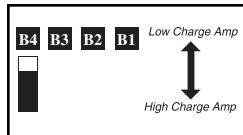

Battery Charger	Switch Position
Low Charge Amps	Up (factory setting)
High Charge Amps	Down

CAUTION: When switching to the High Charge Amp setting, the user must ensure that the amp hour capacity of their battery system exceeds the amperage of the High Charge Amp setting or the batteries may be damaged or degraded.

Set Battery Charge Conserver (Load Sense) Dial—OPTIONAL

In order to save battery power, the unit's inverter automatically shuts off in the absence of any power demand from connected equipment or appliances (the electrical load). When the unit detects a load, it automatically turns its inverter function on. Users may choose the minimum load the Inverter/Charger will detect by adjusting the Battery Charge Conserver Dial (see diagram). Using a small tool, turn the dial clockwise to lower the minimum load that will be detected, causing the inverter to turn on for smaller loads. When the dial is turned fully clockwise, the inverter will operate even when there is no load. Turn the dial counterclockwise to increase the minimum load that will be detected, causing the inverter to stay off until the new minimum load is reached.



Note: the factory setting for the dial is fully clockwise. However, based on the threshold load to which you'd like the inverter to respond, you should adjust the dial counterclockwise to reduce its sensitivity until the inverter is active only when connected equipment or appliances are actually in use.

Connect Remote Control—OPTIONAL

Model features a 8-conductor telephone style receptacle on the front panel for use with an optional remote control module (Tripp Lite model APSRM4, sold separately). The remote module allows the Inverter/Charger to be mounted in a compartment or cabinet out of sight, while operated conveniently from a remote location. See instructions packed with the remote control module.

Connect Battery Temperature Sensing Cable—OPTIONAL

The battery temperature sensing function prolongs battery life by adjusting the charge float voltage level based on battery temperature. Connect the sensor cable (the cable, sold separately, has an RJ style connector on one end and a black sensor on the other) to the RJ style jack located on the side of the Inverter/Charger labeled "Remote Temp. Sense." With user-supplied electrical or duct tape, affix the sensor to the side of the battery below the electrolyte level. Make sure that nothing, not even tape, comes between the sensor and the side of the battery. To guard against false readings due to ambient temperature, place the sensor between batteries, if possible, or away from sources of extreme heat or cold. If the sensor cable is not used, the Inverter/Charger will charge according to its default 25° C values.

Battery Selection

Select Battery Type

Select "Deep Cycle" batteries to receive optimum performance from your Inverter/Charger. Do not use ordinary car or starting batteries or batteries rated in Cold Cranking Amps (CCA). If the batteries you connect to the Inverter/Charger are not true Deep Cycle batteries, their operational lifetimes may be significantly shortened. If you are using the same battery bank to power the Inverter/Charger as well as DC loads, your battery bank will need to be appropriately sized (larger loads will require a battery bank with a larger amp-hour capacity) or the operational lifetimes of the batteries may be significantly shortened.

Batteries of either Wet-Cell (vented) or Gel-Cell /Absorbed Glass Mat (sealed) construction are ideal. 6-volt "golf cart", Marine Deep-Cycle or 8D Deep-Cycle batteries are also acceptable. You must set the Inverter/Charger's Battery Type DIP Switch (see Configuration section for more information) to match the type of batteries you connect or your batteries may be degraded or damaged over an extended period of time. In many cases, the vehicle battery may be the only one installed. Auxiliary batteries must be identical to the vehicle batteries if they are connected to each other.

Match Battery Amp-Hour Capacity to Your Application

Select a battery or system of batteries that will provide your Inverter/Charger with proper DC voltage and an adequate amp-hour capacity to power your application. Even though Tripp Lite Inverter/Chargers are highly-efficient at DC-to-AC inversion, their rated output capacities are limited by the total amp-hour capacity of connected batteries and the support of your vehicle's alternator if the engine is kept running.

• STEP 1: Determine Total Wattage Required

Add the wattage ratings of all equipment you will connect to your Inverter/Charger. Wattage ratings are usually listed in equipment manuals or on nameplates. If your equipment is rated in amps, multiply that number times AC utility voltage to determine watts. (Example: a ¼ in. drill requires 2½ amps. 2½ amps × 120 volts = 300 watts.)

Note: Your Inverter/Charger will operate at higher efficiencies at about 75% - 80% of nameplate rating.

• STEP 2: Determine DC Battery Amps Required

Divide the total wattage required (from step 1, above) by the battery voltage (12) to determine the DC amps required.

• STEP 3: Estimate Battery Amp-Hours Required (for operation unsupported by the alternator)

Multiply the DC amps required (from step 2, above) by the number of hours you estimate you will operate your equipment exclusively from battery power before you have to recharge your batteries with utility- or generator-supplied AC power. Compensate for inefficiency by multiplying this number by 1.2. This will give you a rough estimate of how many amp-hours of battery power (from one or several batteries) you should connect to your Inverter/Charger.

NOTE! Battery amp-hour ratings are usually given for a 20-hour discharge rate. Actual amp-hour capacities are less when batteries are discharged at faster rates. For example, batteries discharged in 55 minutes provide only 50% of their listed amp-hour ratings, while batteries discharged in 9 minutes provide as little as 30% of their amp-hour ratings.



• STEP 4: Estimate Battery Recharge Required, Given Your Application

You must allow your batteries to recharge long enough to replace the charge lost during inverter operation or else you will eventually run down your batteries. To estimate the minimum amount of time you need to recharge your batteries given your application, divide your required battery amp-hours (from step 3, above) by your Inverter/Charger's rated charging amps.



NOTE! For Tripp Lite Inverter/Chargers providing 1000 watts or less of continuous AC power, a full-size battery will normally allow sufficient power for many applications before recharging is necessary. For mobile applications, if a single battery is continuously fed by an alternator at high idle or faster, then recharging from utility or generator power may not be necessary. For Tripp Lite Inverter/Chargers over 1000 watts used in mobile applications, Tripp Lite recommends you use at least two batteries, if possible fed by a heavy-duty alternator anytime the vehicle is running. Tripp Lite Inverter/Chargers will provide adequate power for ordinary usage within limited times without the assistance of utility or generator power. However, when operating extremely heavy electrical loads at their peak in the absence of utility power, you may wish to "assist your batteries" by running an auxiliary generator or vehicle engine, and doing so at faster than normal idling.

Example

Tools

¼" Drill	Orbital Sander	Cordless Tool Charger	
			
300W	+	220W	+
		20W	=
			540W

Appliances

Blender	Color TV	Laptop Computer	
			
300W	+	140W	+
		100W	=
			540W

$$540 \text{ watts} \div 12\text{V} = 45 \text{ DC Amps}$$

$$45 \text{ DC Amps} \times 5 \text{ Hrs. Runtime} \\ \times 1.2 \text{ Inefficiency Rating} = 270 \text{ Amp-Hours}$$

$$270 \text{ Amp-Hours} \div 55 \text{ Amps} \\ \text{Inverter/Charger Rating} = 5 \text{ Hours Recharge}$$

Mounting



WARNING! Mount your Inverter/Charger BEFORE DC battery and AC power connection. Failure to follow these instructions may lead to personal injury and/or damage to the Inverter/Charger and connected systems.

Tripp Lite recommends permanent mounting of your Inverter/Charger as illustrated below. User must supply mounting hardware and is responsible for determining if the hardware and mounting surface are suitable to support the weight of the Inverter/Charger. Contact Tripp Lite if you require further assistance in mounting your Inverter/Charger.

Install your Inverter/Charger in a location where it will be shielded from outside weather conditions. Do not mount unit with its front or rear panel facing down (at any angle). Mounting in this manner will seriously inhibit the unit's internal cooling, eventually causing product damage not covered under warranty.

A Using the measurements from the diagram, install two user-supplied 1/4" (6 mm) fasteners into a rigid horizontal surface, leaving the heads slightly raised. **B** Slide the Inverter/Charger forward over the fasteners to engage the mounting feet molded on the front of the Inverter/Charger cabinet. Install and tighten additional user-supplied 1/4" (6 mm) fasteners into the mounting feet molded on the rear and sides of the Inverter/Charger cabinet*. The rear feet extend beyond the unit's cabinet to provide for adequate ventilation space behind the cooling fan(s); they should not be removed.

The polycarbonate cabinet and mounting feet of your Inverter/Charger are durable enough to allow for vertical mounting as well, if your vehicle compartment requires this configuration. For vertical mounting, the control panel of the Inverter/Charger should face either side.

Allow 2" minimum front and rear clearance for adequate ventilation.

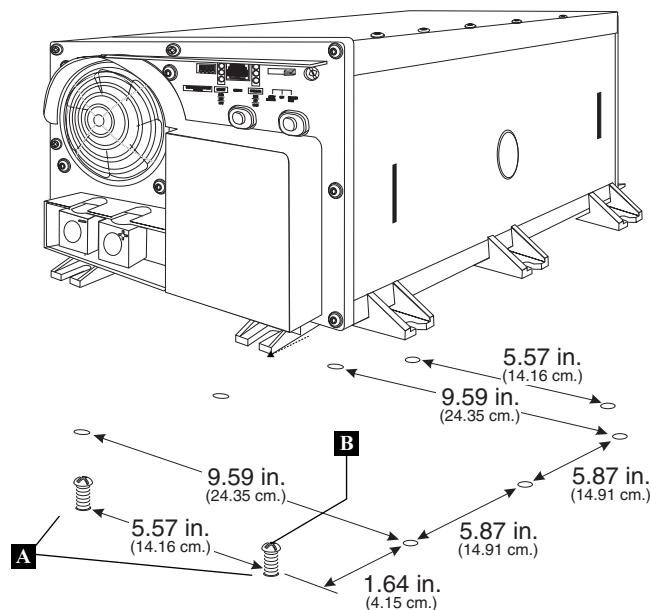

Battery Connection

Connect your Inverter/Charger to your batteries using the following procedures:

- Connect DC Wiring:** Though your Inverter/Charger is a high-efficiency converter of electricity, its rated output capacity is limited by the length and gauge of the cabling running from the battery to the unit. Use the shortest length and largest diameter cabling (maximum 2/0 gauge) to fit your Inverter/Charger's DC Input terminals (see table below). Shorter and heavier gauge cabling reduces DC voltage drop and allows for maximum transfer of current. Your Inverter/Charger is capable of delivering peak wattage at up to 200% of its rated continuous wattage output for brief periods of time. Heavier gauge cabling should be used when continuously operating heavy draw equipment under these conditions. Tighten your Inverter/Charger and battery terminals to approximately 3.5 Newton-meters of torque to create an efficient connection and to prevent excessive heating at this connection. Insufficient tightening of the terminals could void your warranty.

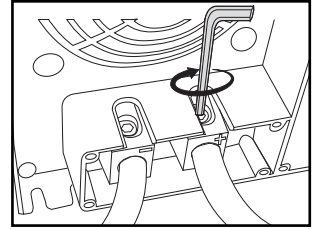

DC Connectors

Maximum Recommended DC Cable Length

Maximum Distance From Battery to Inverter/Charger

Output	Wire Gauge (AWG)				
	6	4	2	0	00 (2/0)
750W	10 ft	16 ft	26 ft	42 ft	52 ft
1250W	Do Not Use	Do Not Use	16 ft	25 ft	31 ft
2000W	Do Not Use	Do Not Use	Do Not Use	Do Not Use	20 ft

Warning: Do not use a wire gauge smaller than 6 AWG.

- Connect Ground:** Using a #8 AWG wire or larger directly connect the Main Ground Lug to the vehicle's chassis or earth ground. See the Feature Identification section to locate the Main Ground Lug on your specific Inverter/Charger model. All installations must comply with national and local codes and ordinances.
- Connect Fuse:** NEC (National Electrical Code) article 551 requires that you connect all of your Inverter/Charger's positive DC Terminals directly to a UL-listed fuse(s) and fuse block(s) within 18 inches of the battery. The fuse's rating must equal or exceed the minimum DC fuse rating displayed on the Inverter/Charger's nameplate. See diagrams below for proper fuse placement.



WARNING! • Failure to properly ground your Inverter/Charger to a vehicle's chassis or earth ground may result in a lethal electrical shock hazard.

- Never attempt to operate your Inverter/Charger by connecting it directly to output from an alternator rather than a battery or battery bank.
- Observe proper polarity with all DC connections.

Non-Vehicular or Vehicular

Your Inverter/Charger's Nominal DC Input Voltage **must match** the voltage of your battery or batteries—12 Volts in most vehicular applications.

It is possible to connect your Inverter/Charger to the main battery within your vehicle's electrical system. In most vehicles, the Inverter/Charger will be connected to one or more dedicated auxiliary (house) batteries that are isolated from the drive system to prevent possible draining of the main battery.

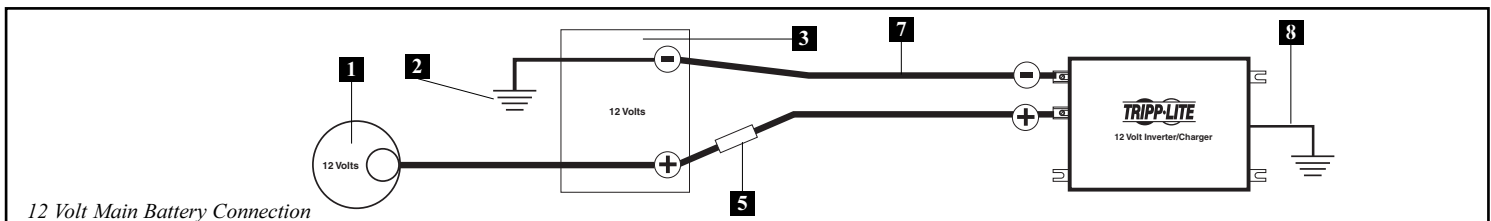

12 Volt Main Battery Connection

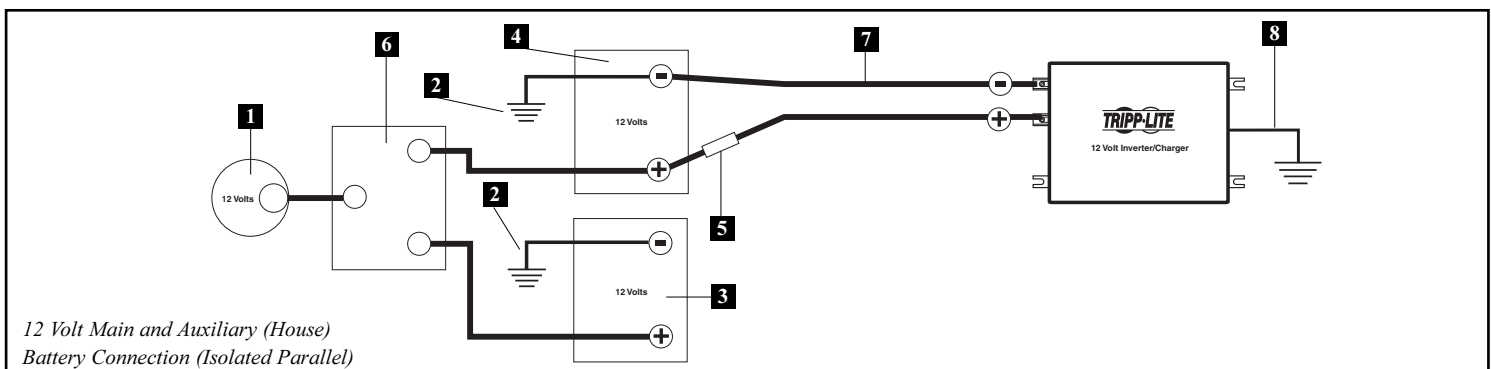

12 Volt Main and Auxiliary (House) Battery Connection (Isolated Parallel)

- 1** 12 Volt Alternator **2** Vehicle Battery Ground **3** 12 Volt Main Battery **4** 12 Volt Auxiliary (House) Battery **5** UL-Listed Fuse & Fuse Block (mounted within 18 inches of the battery) **6** Battery Isolator **7** Large Diameter Cabling, Maximum 2/0 Gauge to Fit Terminals **8** 8 AWG (minimum) Ground Wire

AC Input/Output Connection

To avoid overloading your Inverter/Charger, match the power requirements of the equipment you plan to run at any one time (add their total watts) with the output wattage capacity of your Inverter/Charger model (see Specifications). Do not confuse “continuous” wattage with “peak” wattage ratings. Most electric motors require extra power at start-up (“peak wattage”) than required to run continuously after start-up, sometimes over 100% more. Some motors, such as in refrigerators and pumps, start and stop intermittently according to demand, requiring “peak wattage” at multiple, unpredictable times during operation.

OverPower™ Feature

Tripp Lite Inverter/Chargers deliver up to 150% of their nameplate-rated wattage for 1-60 minutes under ideal battery and temperature conditions, providing ample reserve power to support tools and equipment.*

** For best results, utilize OverPower for as short a duration as possible, ensure that battery bank and cabling are able to provide full nominal DC voltage under load, and allow the inverter/charger to cool completely before and after OverPower utilization.*

DoubleBoost™ Feature

Tripp Lite Inverter/Chargers deliver up to twice their nameplate-rated wattage for up to 10 seconds, providing the extra power needed to cold-start heavy-duty tools and equipment.*

** Actual duration depends on model, battery age, battery charge level and ambient temperature.*



Warning! Consult a qualified electrician and follow all applicable electrical codes and requirements for hardwire connection. Disconnect both DC input and AC utility supply before attempting hardwiring. Use wire type THHN or equivalent with minimum temperature rating of 90°C.

Hardwire Connection

Remove the screws and cover plate over the hardwire terminal box. Remove the knockout covers closest to the desired electrical source and to your equipment. Attach ½" diameter conduits (user-supplied) to the knockouts and thread wires through. Connect the conduits to each other with the ground bond connection supplied.

Ground*

- Connect the incoming and outgoing ground wires to the ground (green) terminal **1**.

AC Input

- Connect the incoming hot wire to the input hot (brown) terminal **2**.
- Connect the incoming neutral wire to the input neutral (blue) terminal **3**.

AC Output

- Connect the outgoing hot wire to the output hot (black) terminal **4**.
- Connect the outgoing neutral wire to the output neutral (white) terminal **5**.
- Replace cover plate and tighten screws.

** If the incoming conduit only contains two wires (hot and neutral), the incoming conduit must be bonded to the main ground lug on the unit. In any case, the incoming conduit must be bonded to earth or vehicle ground, and the incoming conduit must be bonded to the outgoing conduit.*

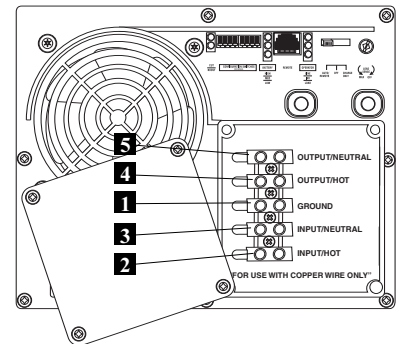

Service

Before returning your Inverter/Charger for service, follow these steps: 1.) Review the installation and operation instructions to ensure that the service problem does not originate from a misreading of the instructions. Also, check that the circuit breaker(s) are not tripped.* 2.) If the problem continues, do not contact or return the Inverter/Charger to the dealer. Instead, call Tripp Lite at (773) 869-1233. A service technician will ask for the Inverter/Charger’s model number, serial number and purchase date and will attempt to correct the problem over the phone. 3.) If the problem requires service, the technician will issue you a Returned Material Authorization (RMA) number, which is required for service. Securely pack the Inverter/Charger to avoid damage during shipping. Do not use Styrofoam beads for packaging.** Any damages (direct, indirect, special, incidental or consequential) to the Inverter/Charger incurred during shipment to Tripp Lite or an authorized Tripp Lite service center is not covered under warranty. Inverter/Chargers shipped to Tripp Lite or an authorized Tripp Lite service center must have transportation charges prepaid. Mark the RMA number on the outside of the package. If the Inverter/Charger is within the warranty period, enclose a copy of your sales receipt. Return the Inverter/Charger for service using an insured carrier to the address given to you by the Tripp Lite service technician.

** This is a common cause of service inquiries which can be easily remedied by following the resetting instructions in this manual. ** If you require packaging, the technician can arrange to send you proper packaging.*

Maintenance

Your Inverter/Charger requires no maintenance and contains no user-serviceable or replaceable parts, but should be kept dry at all times. Periodically check, clean and tighten all cable connections, as necessary, both at the unit and at the battery.

Troubleshooting

Try these remedies for common Inverter/Charger problems before calling for assistance. Call Tripp Lite Customer Service at (773) 869-1234 before returning your unit for service.

SYMPTOM	PROBLEMS	CORRECTIONS
No AC Output (All Indicator Lights are OFF)	Unit is not properly connected to utility power	Connect unit to utility power.
	Operating Mode Switch is set to "DC OFF" and AC input is present.	Set Operating Mode Switch to "AUTO/REMOTE" or "CHARGE ONLY".
	This is normal when the Operating Mode Switch is set to "CHARGE ONLY" and AC input is absent.	No correction is required. AC output will return when AC input returns. Set Operating Mode Switch to "AUTO/REMOTE" if you require AC output.
	Output circuit breaker is tripped.	Reset circuit breaker.
	Unit has shut down due to battery overcharge (preventing battery damage). The problem may be with connected auxiliary chargers, if any, or with the unit's charger.	Disconnect any auxiliary chargers. Reset by moving Operating Mode Switch to "DC OFF". Wait 1 minute and switch to "AUTO/REMOTE" or "CHARGE ONLY". If unit remains in shutdown mode after several attempts to reset, contact Tripp Lite Customer Service for assistance.
	Unit has shut down due to excessive battery discharge.	Use an auxiliary charger* to raise battery voltage. Check external battery connections and fuse. Unit automatically resets when condition is cleared.
Battery Not Recharging (AC Input Present)	Unit has shut down due to overload.	Reduce load. Reset by moving Operating Mode Switch to "DC OFF". Wait 1 minute. Switch to "AUTO/REMOTE" or "CHARGE ONLY".
	Connected batteries are dead.	Check and replace old batteries.
	Battery fuse* is blown.	Check and replace fuse.*
	Battery cabling* is loose.	Check and tighten or replace cabling.*
	Unit has shut down due to battery overcharge (preventing battery damage). The problem may be with connected auxiliary chargers, if any, or with the unit's charger.	Disconnect any auxiliary chargers. Reset by moving Operating Mode Switch to "DC OFF". Wait 1 minute and switch to "AUTO/REMOTE" or "CHARGE ONLY." If unit remains in shutdown mode after several attempts to reset, contact Tripp Lite Customer Service for assistance.
All Three "BATT VOLT/CHRG CURR" LEDs are slowly flashing (½ second flashes) with Operating Mode Switch in the "AUTO/REMOTE" position.	Charger circuit breaker is tripped.	Reset circuit breaker.
	Battery is excessively discharged. Unit will shut down to prevent battery damage.	Use an auxiliary charger* to raise battery voltage. Check external battery connections and fuse. Unit automatically resets when condition is cleared.
All Three "BATT VOLT/CHRG CURR" LEDs are rapidly flashing (¼ second flashes) with Operating Mode Switch in the "AUTO/REMOTE" position.	Battery is overcharged. Unit will shut down to prevent battery damage. The problem may be with connected auxiliary chargers, if any, or with the unit's charger.	Disconnect any auxiliary chargers. Reset by moving Operating Mode Switch to "DC OFF". Wait 1 minute and switch to "AUTO/REMOTE." If unit remains in shutdown mode after several attempts to reset, contact Tripp Lite Customer Service for assistance.
Red "LOW" Battery Indicator Light is flashing with Operating Mode Switch in the "AUTO/REMOTE" position.	Battery voltage is low. Unit has shut down to protect battery from damage.	If AC power (utility- or generator-supplied) is present, the unit will automatically reset itself and start recharging connected batteries. However, if an external charger is used to recharge the batteries, you will need to manually reset the unit by moving the Operating Mode Switch to "DC OFF" for two seconds then returning it to "AUTO/REMOTE".
	False reading due to undersized or insufficiently connected DC cabling.	Use sufficient size DC cable sufficiently connected to Inverter/Charger.
Red "LOAD" Operation Indicator Light flashing	Inverter is overloaded. Unit will automatically shut down after 5 seconds.	Reduce load. Reset by moving Operating Mode Switch to "DC OFF". Wait 1 minute. Switch to "AUTO/REMOTE" or "CHARGE ONLY".

* User-supplied.

Limited Warranty

Tripp Lite warrants its Inverter/Chargers to be free from defects in materials and workmanship for a period of one year (except for outside of U.S.A., Canada and Mexico-120 days) from the date of retail purchase by end user

Tripp Lite's obligation under this warranty is limited to repairing or replacing (at its sole option) any such defective products. To obtain service under this warranty you must obtain a Returned Material Authorization (RMA) number from Tripp Lite or an authorized Tripp Lite service center. Products must be returned to Tripp Lite or an authorized Tripp Lite service center with transportation charges prepaid and must be accompanied by a brief description of the problem encountered and proof of date and place of purchase. This warranty does not apply to equipment which has been damaged by accident, negligence or misapplication or has been altered or modified in any way, including opening of the unit's casing for any reason. This warranty applies only to the original purchaser who must have properly registered the product within 10 days of retail purchase.

EXCEPT AS PROVIDED HEREIN, TRIPP LITE MAKES NO WARRANTIES, EXPRESS OR IMPLIED, INCLUDING WARRANTIES OF MERCHANTABILITY AND FITNESS FOR A PARTICULAR PURPOSE. Some states do not permit limitation or exclusion of implied warranties; therefore, the aforesaid limitation(s) or exclusion(s) may not apply to the purchaser.

EXCEPT AS PROVIDED ABOVE, IN NO EVENT WILL TRIPP LITE BE LIABLE FOR DIRECT, INDIRECT, SPECIAL, INCIDENTAL OR CONSEQUENTIAL DAMAGES ARISING OUT OF THE USE OF THIS PRODUCT, EVEN IF ADVISED OF THE POSSIBILITY OF SUCH DAMAGE. Specifically, Tripp Lite is not liable for any costs, such as lost profits or revenue, loss of equipment, loss of use of equipment, loss of software, loss of data, costs of substitutes, claims by third parties, or otherwise

WARRANTY REGISTRATION

Visit www.tripp-lite.com/warranty to register the warranty of your new Tripp Lite product. You'll be automatically entered into a drawing for a chance to win a FREE Tripp Lite product!

* No purchase necessary. Void where prohibited. Some restrictions apply. See website for details.

Note on Labeling Two symbols are used on the labels.

V~: AC Voltage V ---: DC Voltage

Regulatory Compliance Identification Numbers

For the purpose of regulatory compliance certifications and identification, your Tripp Lite product has been assigned a unique series number. The series number can be found on the product nameplate label, along with all required approval markings and information. When requesting compliance information for this product, always refer to the series number. The series number should not be confused with the marking name or model number of the product.

Tripp Lite has a policy of continuous improvement. Specifications are subject to change without notice.



1111 W. 35th Street, Chicago, IL 60609 USA
773.869.1234 (USA) • 773.869.1212 (International)
www.tripplite.com

Free Manuals Download Website

<http://myh66.com>

<http://usermanuals.us>

<http://www.somanuals.com>

<http://www.4manuals.cc>

<http://www.manual-lib.com>

<http://www.404manual.com>

<http://www.luxmanual.com>

<http://aubethermostatmanual.com>

Golf course search by state

<http://golfingnear.com>

Email search by domain

<http://emailbydomain.com>

Auto manuals search

<http://auto.somanuals.com>

TV manuals search

<http://tv.somanuals.com>