

OWNER/OPERATOR MANUAL

TROY-BILT

TUFF-CUT[®]

HIGH WHEEL MOWER



**Assembly, Safety, Operating and Maintenance Instructions.
PLEASE READ CAREFULLY!**

TABLE OF CONTENTS

	Page		Page
INTRODUCTION	1	SECTION 5: MAINTENANCE AND ADJUSTMENTS	
FOR SERVICE OR PARTS	1	Maintenance Chart	21
MOWER IDENTIFICATION NUMBERS	1	Adjusting Wheel Drive Traction	22
SECTION 1: RULES FOR SAFE OPERATION		Height of Cut Adjustment	23
Training	2	Handlebar Height Adjustment	23
Preparation	2	Sharpening or Replacing the Mower Blade ..	24
Operation	3	Clean the Mower Housing and Discharge	
Maintenance and Storage	4	Chute	25
Safety Decals	4	Check Tire Pressure	25
SECTION 2: ASSEMBLY INSTRUCTIONS		Check Bolts, Screws and Nuts	25
Check For Shipping Damage	5	Lubrication	25
Tools Needed For Assembly	5	Wheel Drive Belt Tension	25
Mower Assembly Steps	5	Replacing the Wheel Drive Belt	26
Electric Start Assembly Steps	10	Blade Drive Belt Tension	27
SECTION 3: MOWER AND ENGINE CONTROLS		Replacing the Blade Drive Belt	28
Blade Drive Controls	15	Wheel Drive Chain Tension	29
Wheel Drive Controls	16	Replacing the Blade Brake Band	29
Handlebar Height Adjustment	16	Battery Care In Service	30
Height of Cut Adjustment	16	Battery Storage	31
Engine Throttle Control	16	Battery Removal and Replacement	31
Fuel Shut-Off Valve	17	Starting the Electric Start	
Engine Recoil Starter	17	Engine With the Recoil Starter	32
Key Switch Starter	17	Engine Crankcase Oil	32
SECTION 4: OPERATING INSTRUCTIONS		Engine Air Cleaner	33
Preparation Before Starting	18	Carburetor Adjustments	33
To Start the Engine	19	Air Cooling Service	33
To Engage the Blade	19	Spark Plug	33
To Engage the Wheels	20	Throttle Cable Adjustments	33
To Stop the Engine	20	Off-Season Storage	33
Operating the Mower	20	Engine Identification Numbers	33
		Blade Brake Control Test Procedure	34
		SECTION 6: TROUBLESHOOTING	35
		Swivel Wheel Kit	36
		MAINTENANCE RECORD .. Inside Back Cover	

MODEL IDENTIFICATION



22" Push Model. 5HP
Recoil Start Engine.



22" Self-Propelled Model.
5HP Recoil Start or
optional Electric Start Engine.



24" Self-Propelled Model.
8HP Recoil Start or
optional Electric Start Engine.

NOTE: Optional swivel wheels are available for your TUFF-CUT® Mower. Please refer to Page 36 for additional details.

INTRODUCTION

Dear Owner:

We at Garden Way want to thank you for purchasing our TROY-BILT TUFF-CUT® High Wheel Mower.

Your new mower is a professional-quality, rugged machine that will handle most terrain and perform dependably for many long hours of heavy use. The big rear wheels roll smoothly through tall grass, and over uneven ground and rough areas with ease. Its perfect balance makes it much more responsive and maneuverable than conventional mowers. And its wide mowing path, extra horsepower, and easy trimming abilities mean you'll get your mowing chores done in as little time as possible.

We have prepared this Manual to assist you in the safe operation and care of your new TUFF-CUT High Wheel Mower. BEFORE YOU OPERATE THE MOWER PLEASE READ THIS WHOLE MANUAL CAREFULLY! Most importantly, please follow all of the safety instructions given in Section 1, "Rules for Safe Operation." Failure to do so could result in serious injury or damage to equipment or property.

It is our sincere hope that you enjoy using your mower. It is designed and constructed to give you superior results and dependable service. Of course, if you have any questions or problems in operating or servicing your mower, please remember that we are here to serve you. We want to do everything we can to make sure that you are completely satisfied 100 percent of the time.



Thank you,

Dean Leith, Jr.

Dean Leith, Jr.
Sales Manager

FOR SERVICE OR PARTS

For service or operating questions, or replacement parts, you can either contact the factory or see your local servicing dealer. Our addresses and telephone numbers are listed below for your convenience.

Our telephone numbers are:

In the U.S.A.:

For Technical Service call Toll-Free: 1-800-833-6990
For Parts Service call Toll-Free: 1-800-648-6776

In Canada:

Call Toll-Free: 1-800-225-3585

Send correspondence to:

In the U.S.A.:

Troy-Bilt Mfg. Company
102nd St. & 9th Ave.,
Troy, New York 12180

In Canada:

Garden Way Canada, Inc.,
1515 Matheson Blvd., E Unit B11
Mississauga, Ontario L4W 2P5

For engine service, contact an Authorized Briggs & Stratton Service Dealer. Look in the Yellow Pages of your telephone directory, under "Engines-Gasoline." Your Service Dealer can handle all parts, repairs, and warranty service for problems concerning the engine alone. For full details on the engine manufacturer's limited warranty, please see the separate engine owner's pamphlet that was included with this Manual. (If you have any difficulty in locating an authorized dealer or in obtaining warranty service, please contact our Technical Service Department for assistance.)

RECORD YOUR MODEL AND SERIAL NUMBERS

The arrow in the photo below shows the location of the Model and Serial Number decal on your mower. We will need these numbers if you call or write us for parts or service assistance. For ready reference, please record these numbers in the spaces provided below.

MODEL NUMBER: _____

SERIAL NUMBER: _____

DATE OF DELIVERY: _____

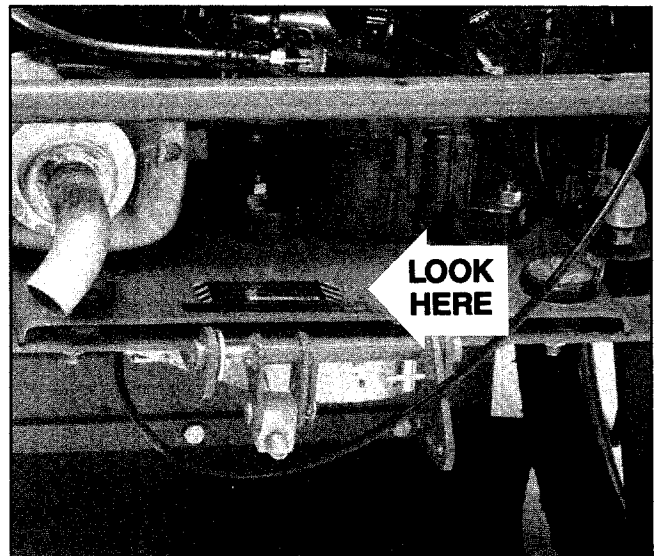

SECTION 1

Rules for Safe Operation

Safe Operation is So Important...

Read the following rules carefully, and pay particular attention to safety instructions printed elsewhere in this manual. Failure to comply with safety instructions could endanger your personal safety and the equipment and property of yourself and others.

SAFETY ALERT SYMBOL

 This symbol is used to alert you to important safety messages in this manual. When you see this symbol, carefully read the message that follows.

The TUFF-CUT® Mower conforms to the CPSC (Consumer Product Safety Commission) safety standard 16 CFR Part 1205 for walk-behind power lawn mowers. The CPSC is an agency of the Federal Government, established and empowered by Congress in 1972, to make and enforce safety standards for consumer products sold in the United States. All rotary walk-behind power lawn mowers manufactured after June 30, 1982 are required to meet CPSC federally-mandated standards. Accordingly, the TUFF-CUT® Mower meets the standards in effect at the time of manufacture.

The TUFF-CUT® Mower also meets voluntary safety standard B-71.1-1986, which is sponsored by the Outdoor Power Equipment Institute and is published by the American National Standards Institute.

TRAINING:

1. Read both this Owner/Operator Manual and the separate engine owner's pamphlet completely before using the mower. Be thoroughly familiar with the controls and proper use of the mower. Know how to stop the mower and disengage the controls quickly in an emergency.
2. Never allow children to operate the mower. Do not allow adults to operate the mower without proper instruction.
3. Keep the area of operation clear of all persons, particularly small children, and pets.
4. Under California law, and under the laws of several other states, you are not permitted to operate an internal combustion engine using hydrocarbon fuels on any forest-covered, brush-covered, or grass-covered land, or on land covered with grain, hay, or other flammable agricultural crop, without an engine spark arrester in continuous effective working order.

The engine on your power equipment, like most outdoor power equipment, is an internal combustion engine that burns gasoline, a hydrocarbon fuel. Therefore, your power equipment must be equipped with a spark arrester

in continuous effective working order. The spark arrester must be attached to the engine exhaust system in such a manner that flames or heat from the system will not ignite flammable material. Failure of the owner/operator of the equipment to comply with this regulation is a misdemeanor under California law, and may also be a violation of other state and/or federal regulations, laws, ordinances, or codes. Contact your local fire marshall or forest service for specific information about what regulations apply in your area.

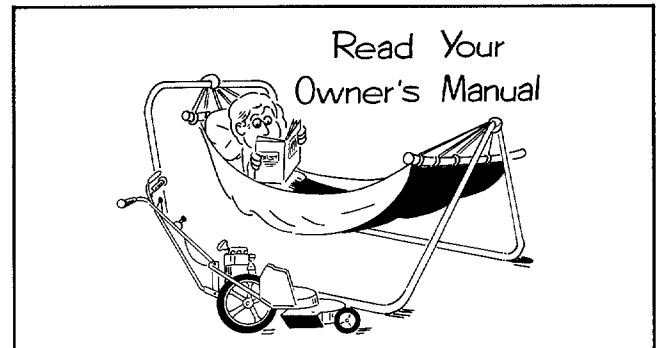

PREPARATION:

1. Thoroughly inspect the area where the mower is to be used and remove all stones, sticks, wires, bones, nails and other foreign objects.
2. Do not operate the mower when barefoot or wearing open sandals. Always wear substantial footwear. The operation of any powered machine can result in foreign objects being thrown by high speed rotating parts. Always wear approved safety glasses or other eye protection when using the mower.
3. Do not wear loose-fitting clothing that could get caught in moving parts.
4. Mow only in daylight, or in good artificial light.
5. Disengage the blade drive mechanism, and the self-propelled mechanism on units so equipped, before starting the engine.
6. Never operate the mower in wet grass. Always be sure of your footing; keep a firm hold on the handlebar and walk; never run.

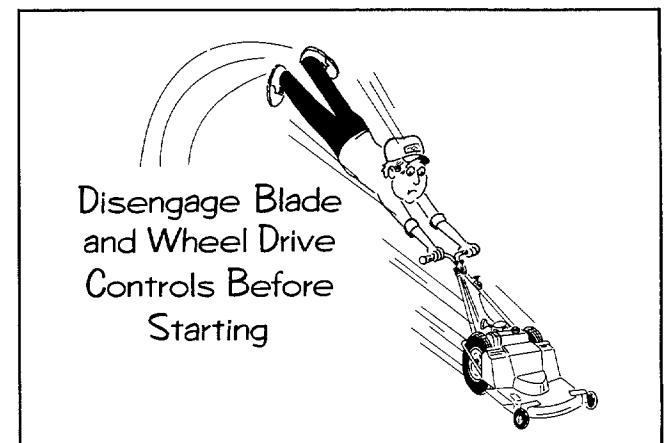

7. Never attempt to make a wheel height adjustment while the engine is running.
8. Never operate the mower without the grass discharge deflector and all guards in place.
9. Never attempt to disconnect any safety devices or to defeat the purpose of these safety devices.
10. Gasoline is highly flammable and its vapors are explosive. Handle with extreme care. Use an approved fuel container.
11. Check the fuel before starting the engine. Do not fill the gasoline tank indoors, when the engine is running or until the engine has been allowed to cool for several minutes after running. Replace the fuel cap securely and clean off any spilled gasoline before starting the engine.
12. Keep smoking materials, sparks and flame away from the fuel tank or fuel container.
13. Move machine away from gasoline fumes before starting engine.
14. **Poison/Danger — Causes Severe Burns.** The battery on electric start models contains sulfuric acid. Avoid contact with skin, eyes or clothing. Antidote: **EXTERNAL** - Flush immediately with lots of water. **INTERNAL** - Drink large quantities of water or milk. Follow with milk of magnesia, beaten egg or vegetable oil. Call physician immediately. Eyes - Flush with water for 15 minutes and get prompt medical attention. Keep out of reach of children.
15. Batteries produce explosive gases. Keep sparks, flame, or cigarettes away. Ventilate when charging or using in an enclosed space. Always shield eyes when working near batteries.
16. At the start of each season and every 10 operating hours, perform the Blade Brake Control Test Procedure described on Page 34.

OPERATION:

1. Do not put hands or feet near or under any rotating parts. Keep clear of the mower blade and discharge opening at all times.
2. Do not change the engine governor settings or over-speed the engine.

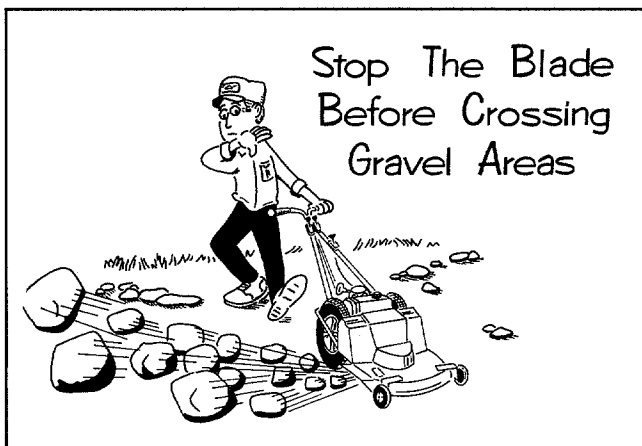

3. Stop the blade when crossing gravel drives, walks, or roads where thrown objects would be a hazard.
4. Stop the blade when you are approached by any child, pet, or inattentive person. (Curious toddlers can too quickly endanger themselves.)

5. Stop the engine, disconnect the spark plug wire, and wait for all moving parts to stop before inspecting, cleaning, adjusting or repairing the mower.
6. Never leave the mower unattended with the engine running. Disconnect the spark plug wire and keep the wire away from the spark plug to prevent accidental starting. Remove the key on electric start models to prevent unauthorized use.
7. Shut off the engine, disconnect the spark plug wire and keep the wire away from the spark plug to prevent accidental starting. Make sure that rotating parts have completely stopped before cleaning out the discharge opening.

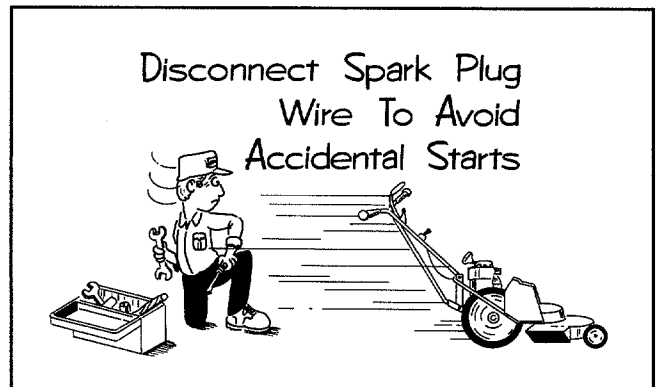

8. If the mower should start to vibrate abnormally, stop the engine, disconnect the spark plug wire, and wait for all moving parts to stop. Then, check immediately for the cause. Vibration is generally a warning of trouble.
9. After striking a foreign object, stop the engine and disconnect the spark plug wire. Keep the spark plug wire away from the plug to prevent accidental starting. Wait for all moving parts to completely stop and then inspect the mower for damage. Repair the damage before restarting and operating the mower.
10. Do not run the engine indoors. Exhaust gases contain carbon monoxide, a deadly gas that is odorless and colorless. Always run the engine outdoors and make sure there is adequate ventilation.
11. The Outdoor Power Equipment Institute recommends that you mow across the face of slopes; never up and down. Exercise extreme caution when changing direction on slopes. Do not mow excessively steep slopes.
12. Do not touch engine parts which may be hot from operation. Allow parts to cool before inspecting, cleaning or repairing.

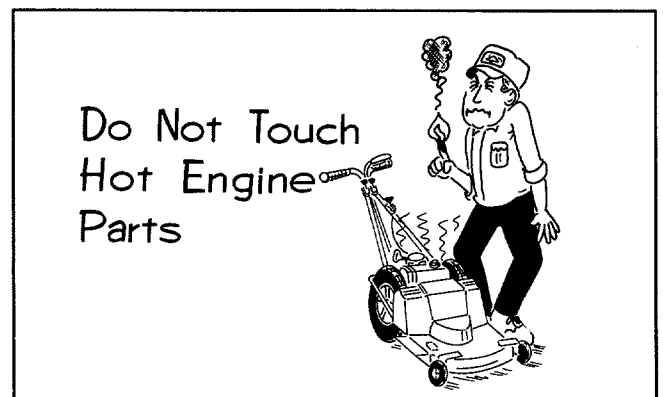

MAINTENANCE AND STORAGE:

1. Check the blade and the engine mounting bolts at frequent intervals for proper tightness.
2. Keep all nuts, bolts, and screws tight to be sure the equipment is in safe working condition.
3. Never store the mower with gasoline in the tank inside a building where fumes may reach an open flame or spark.
4. Allow the engine to cool before storing in any enclosure.

5. To reduce fire hazard, keep the engine free of grass, leaves, or excessive grease.
6. Store gasoline in a cool, well-ventilated area, safely away from any spark or flame-producing equipment. Store in an approved container, safely out of the reach of children.
7. Stop the engine, disconnect the spark plug wire, and wait for all moving parts to stop before inspecting, cleaning, adjusting or repairing the mower. If the engine has been running, allow the hot muffler to cool before working near it.

SAFETY DECALS

Safety decals are located near any area of potential danger. Please contact us for replacement decals if

they are missing, illegible, or damaged. See your Parts Catalog for Part Number identification.

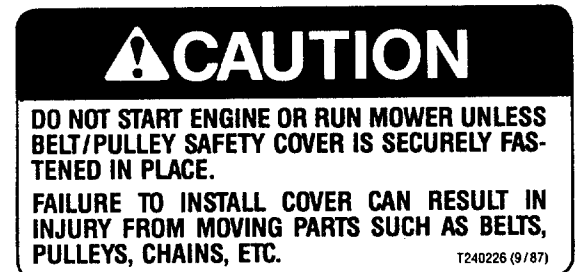

SECTION 2

Assembly Instructions

Your **TUFF-CUT®** Mower is shipped partially unassembled for safe shipment to you. You'll find all the loose parts and necessary hardware packed inside the shipping carton. Please follow the simple steps in this Section for quick, easy and complete mower and engine preparation. After your mower is assembled, carefully read and follow all of the safety and operating instructions in this manual and in the separate engine owner's pamphlet.

IMPORTANT

The engine on your mower was shipped without oil in the crankcase. See Step 6 for oil filling instructions.

CHECK FOR SHIPPING DAMAGE

If you notice any freight damage or missing parts either at the time of delivery or later during assembly, make sure that you put it in writing, within 15 days, that you intend to file a claim. Tell the driver, or phone the truck terminal, that you intend to file a written claim. They will advise you on how to proceed. However, if you have any problems with this procedure, please call us so that we can help you to get satisfaction.

Also, be sure to notify us if you find any parts are missing or damaged. We will arrange to replace damaged or missing parts as quickly as possible.

TOOLS NEEDED FOR ASSEMBLY

All Models:

- Two each of 7/16", 9/16", or Adjustable-Style Wrenches
- Small Adjustable Pliers
- Phillips Head Screwdriver
- Oil Funnel
- Tire Pressure Gauge (pocket-type)

Electric Start Models:

- 1/2" or Adjustable-Style Wrench

MOWER ASSEMBLY STEPS:

NOTE: All references to "Left" and "Right" are given from the operator's position behind the handlebars.

STEP 1: Unpacking and Loose Parts

A. Remove the mower, discharge deflector, and hardware package from the shipping carton (lift carton off base to remove mower). See Photo 2-1.

B. If you ordered an electric start model, also remove the battery carton (containing battery, vent tube, and battery bolts and nuts), the battery mounting bracket assembly, and the battery hold-down clamp. See Photo 2-2.

C. The contents of the hardware bag can be identified by referring to the separate "Hardware Bag Contents" sheet that is included in your literature package.

D. Assembly should be done on a clean, level surface. If you need to move the mower, be careful not to severely bend or stretch any wires or cables.

E. Remove any protective wrapping from the upper and lower ends of the handlebars. Also, there may be a plastic protective cap on the outer ends of the two rear wheel mounting studs. If so, remove and discard the caps.

F. For shipping purposes only, a cardboard sleeve was placed underneath the mower deck. Using care to avoid cutting yourself on the sharpened blade (wear thick gloves for extra protection), raise the front of the mower and remove the cardboard sleeve.

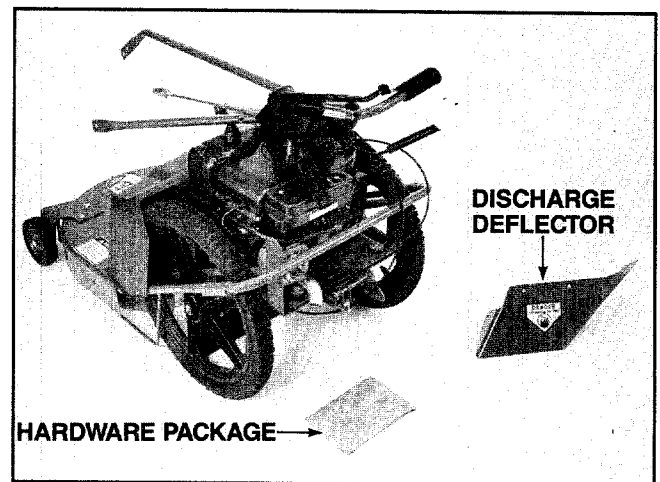

Photo 2-1: Remove mower, discharge deflector and hardware package.

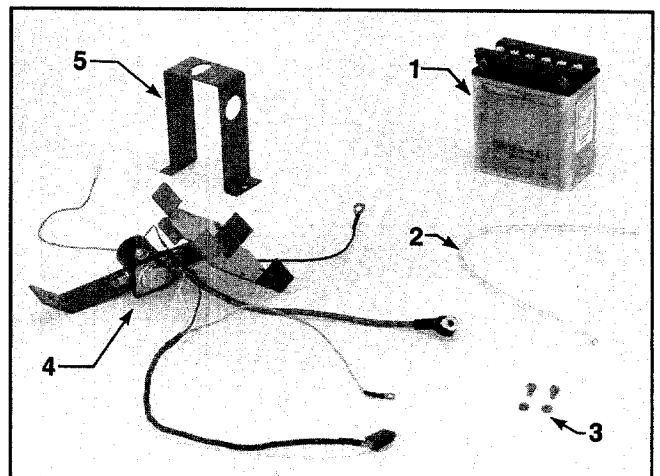

Photo 2-2: Loose parts for electric start models include:

1. Battery
2. Vent Tube
3. Two Bolts and Nuts
4. Battery Mounting Bracket Assembly
5. Battery Hold-Down Clamp

STEP 2: Attach Handlebars

A. Parts Needed: (3) 3/8"–16×3/4" long Hex Hd. Screws, (3) 3/8" Lockwashers, (3) 3/8"–16 Hex Nuts, (1) Plastic Tie (for 22" Mower Only).

B. Gently fold back the handlebars from their shipping position atop the mower and align the holes in the ends of the left and right handlebars with the holes in the mower frame handlebar mounting brackets. See Photo 2-3. Note that the ends of the handlebars can be positioned to either the inside or the outside of the mounting brackets (make certain that both ends are positioned the same way: either both inside or both outside).

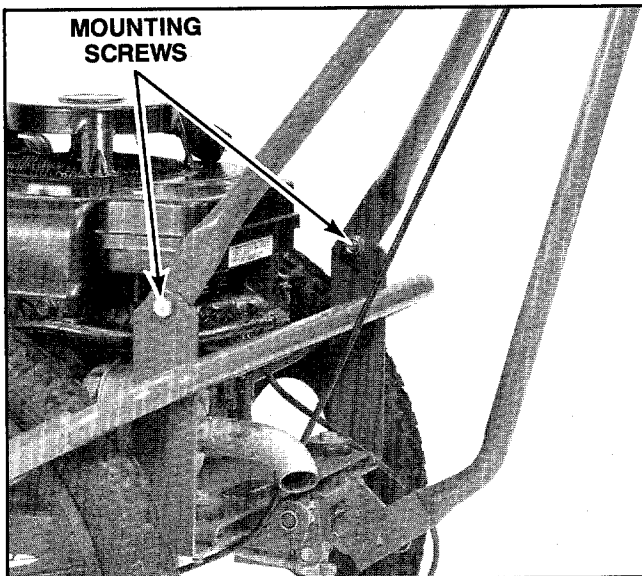

Photo 2-3: Attach left and right handlebars.

C. Install two 3/4" long screws through the mounting holes with the screw heads facing outside. Add 3/8" lockwashers and hex nuts and tighten both screws finger-tight.

D. There are two height adjustment holes at the bottom of the center handlebar brace and two adjustment holes in the height adjustment bracket which is welded to the mower frame. See Photo 2-4. The four holes allow you to choose three different handlebar height positions: LOW, MEDIUM and HIGH.

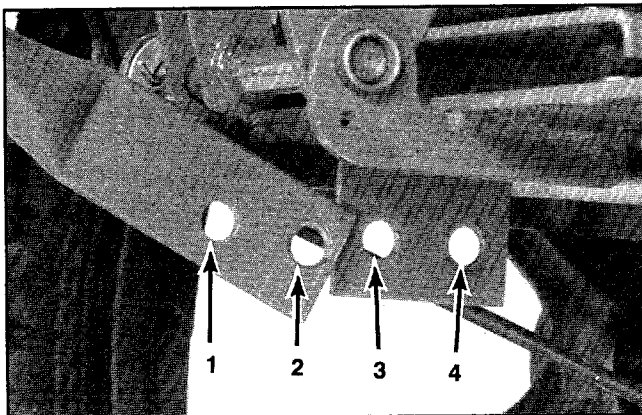

Photo 2-4: Handlebar height adjustment holes. (Bellcrank plate on self-propelled model has been rotated upward for photo clarity.)

E. Select a hole combination according to the chart below, then temporarily insert a 3/4" long screw through the brace and bracket from right to left. Check that the handlebars are set at a comfortable operating height and readjust the setting if necessary. When you are satisfied with the height setting, add a 3/8" lockwasher and 3/8" hex nut and tighten securely using two 9/16" wrenches.

USE HOLES	TO OBTAIN:
1-4	LOWEST HANDLEBAR HEIGHT
1-3 & 2-4	MEDIUM HANDLEBAR HEIGHT
2-3	HIGHEST HANDLEBAR HEIGHT

F. Securely tighten the two upper handlebar mounting screws that you finger-tightened in Step C.

G. On the 22" mower (5HP engine) only, use a plastic tie to secure the blade drive control cable (the thick black cable attached to the blade drive control on the left handlebar) to the center handlebar brace. Locate the tie 3" to 4" above the bend at the lower end of the center brace.

NOTE: For future handlebar height adjustments, refer to the instructions found in Section 5.

STEP 3: Attach Wheel Drive Control Rod (Self-Propelled Models Only)

A. Parts Needed: (1) Clevis Pin, (1) Spring Clip.

B. One end of the upper wheel drive control rod is already attached to the wheel drive lever located on the right side of the handlebars. See Photo 2-5. The clevis at the bottom of the control rod must be attached to the bellcrank located at the rear of the mower. See Photo 2-6.

C. There are three positioning holes in the bellcrank that are identified in Photo 2-6 with the letters "H", "M" and "L". As shown in the chart below, the clevis must be installed in the correct bellcrank hole, relative to the height setting of the handlebars.

USE HOLE	IF HANDLEBARS ARE IN:
"H"	HIGHEST HEIGHT SETTING
"M"	MEDIUM HANDLEBAR SETTING
"L"	LOWEST HANDLEBAR SETTING

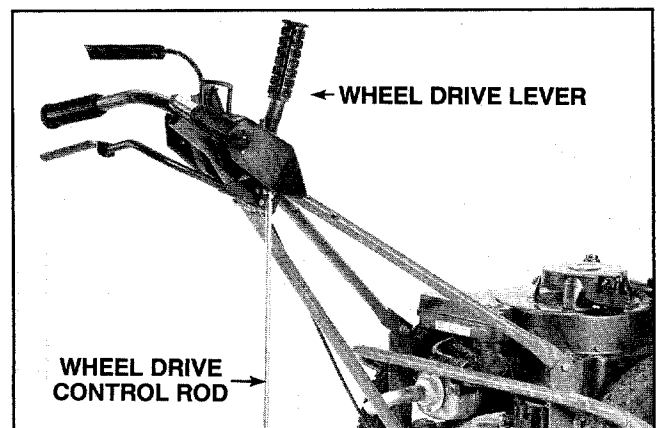

Photo 2-5: Wheel drive lever and upper control rod.

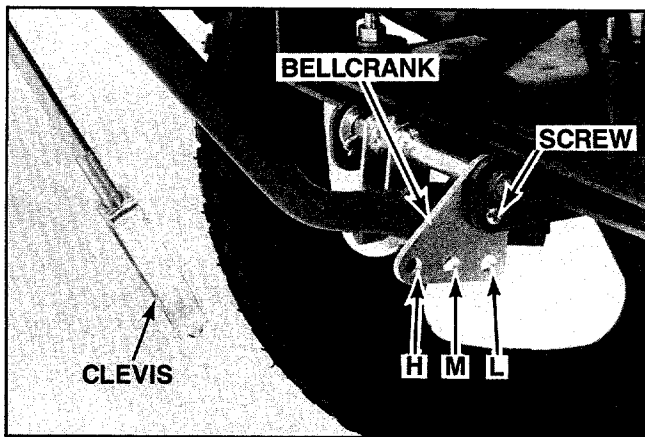

Photo 2-6: Clevis attaches to bellcrank. Do not remove alignment screw and nut during attachment steps.

IMPORTANT

Whenever the handlebar height is changed, the position of the control rod clevis must be changed accordingly. Moving the handlebars changes the tension on the upper control rod and this tension must be adjusted by relocating the clevis in the appropriate bellcrank hole. Refer to the "Handlebar Height Adjustment" instructions in Section 5 for the correct procedure to follow.

D. Before the mower left the factory, the bellcrank was rotated upward and secured in place with a #10-24 x 5/8" long Phillips head screw and #10 lockwasher/nut. See Photo 2-6. This aligns the bellcrank. The bellcrank must be aligned in this manner every time the control rod clevis is relocated to a different bellcrank positioning hole. Do not remove the screw and lockwasher/nut at this time.

NOTE: If the screw and lockwasher/nut has been removed, rotate the bellcrank upward and reinstall the screw and lockwasher/nut.

E. Slide the arms of the clevis over the bellcrank, pushing the clevis forward as far as it will go.

F. Pull the handle on the wheel drive lever all the way back into its most rearward position and, while holding the lever in this position, try to align the clevis hole with the appropriate bellcrank hole. *Do not let the wheel drive lever move from its most rearward position while you are moving the clevis.*

G. If the holes line up, insert the clevis pin through the right side of the clevis and secure it with the spring clip. See Photo 2-7. If the holes do not line up, remove the clevis from the bellcrank and adjust the clevis by rotating it up or down the control rod.

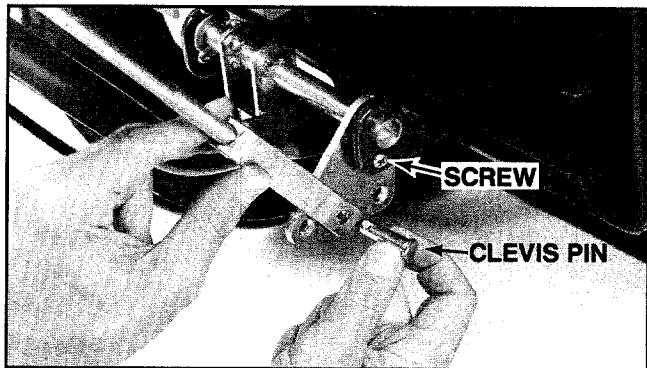

Photo 2-7: Secure clevis with clevis pin and spring clip.

H. Repeat Steps E, F and G until the holes are aligned.

I. Remove the screw and lockwasher/nut (shown in Photos 2-6 & 2-7) from the bellcrank alignment holes. You may have to jiggle the bellcrank slightly to free them. Be sure to save the screw and lockwasher/nut for any future readjustments of the upper wheel drive control rod.

J. At this time, check to see that the wheel drive rollers are not touching the rear tires. See Photo 2-8. With the wheel drive lever in the upward, NEUTRAL position, there should be a **minimum** clearance of 1/16" between the rollers and the tires. This clearance ensures that the rollers will not drive the wheels when the wheel drive lever is in NEUTRAL. If there is not at least 1/16" of clearance, an adjustment must be made before the engine is started. Please refer to Section 5, "Adjusting Wheel Drive Traction" for the necessary adjustment procedure.

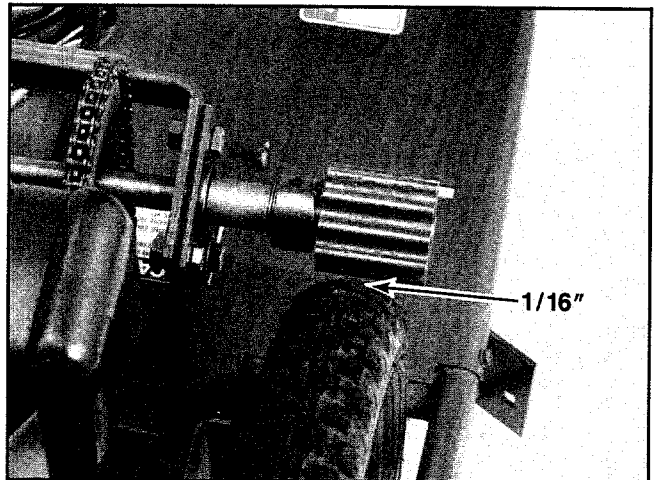

Photo 2-8: Check for minimum clearance of 1/16" between rollers and tires. (Belt/pulley safety cover removed for photo clarity.)

STEP 4: Check Tire Pressure

A. Use a pocket-type tire pressure gage to check the inflation pressures in the rear tires. See Photo 2-9. The tires should be equally inflated to between 25-30 psi.

B. Incorrect or unequal air pressure can result in abnormal tire wear and difficult steering. On self-propelled models, it can result in poor traction between the wheel drive rollers and the tires. For best results, check the inflation pressures after every 10 hours of operation or once a week, whichever occurs sooner.

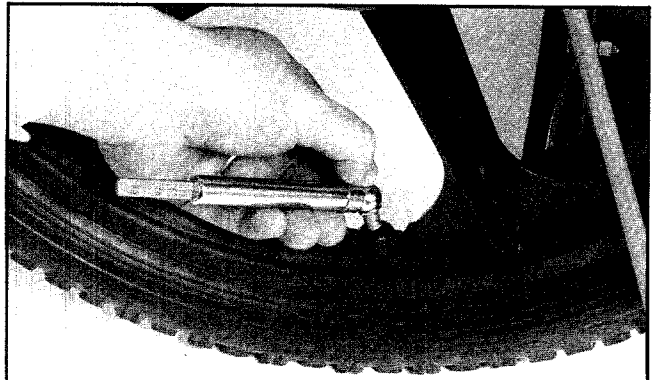

Photo 2-9: Check tire pressures in rear tires.

STEP 5: Attach Mower Discharge Deflector

CAUTION

- The discharge deflector must be installed before operating the mower.
- Before installing the deflector, disconnect the spark plug wire and keep the wire away from the spark plug to prevent accidental starting.
- It will be necessary to reach below the blade housing to install the discharge deflector. Before doing so, put on heavy gloves to protect your hands from the sharpened mower blade.

A. Parts Needed: (1) Discharge Deflector, (4) 1/4"-20 x 5/8" long Carriage Bolts, (4) 1/4" Lockwashers, (4) 1/4"-20 Hex Nuts.

B. It will be easier to install the deflector if you raise the front of the mower a few inches off the ground and then block the rear wheels.

C. Place the discharge deflector on the right side of the mower deck so that the two square holes on the top of the deflector are aligned with the square holes in the top of the mower deck. Make sure that the right side of the deflector overlaps the front wrap of the mower deck and the left side of the deflector overlaps the rear mounting bracket. See Photo 2-10.

D. Insert two 5/8" carriage bolts down through the holes in the top of the deflector and loosely attach 1/4" lockwashers and hex nuts. See Photo 2-10.

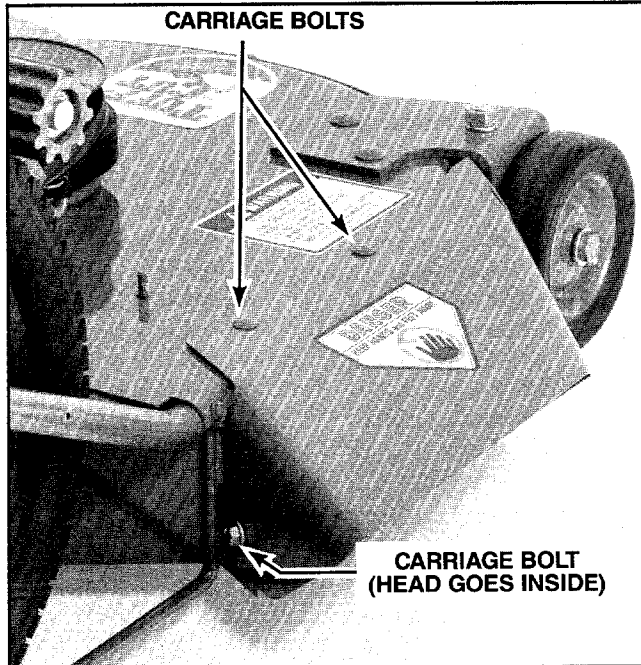

Photo 2-10: Location of three carriage bolts. (Belt/pulley safety cover removed for photo clarity.)

E. Insert a 5/8" carriage bolt from the inside of the mower deck out through the holes in the bottom, left side of the mounting bracket and the deflector. Loosely attach a 1/4" lockwasher and hex nut. See Photo 2-10.

F. On the bottom, right side of the deflector (behind the front wheel), insert a 5/8" carriage bolt from the in-

side of the mower deck out through the holes in the front wrap and the deflector. Loosely attach a 1/4" lockwasher and hex nut. See Photo 2-11. If necessary, loosen the bumper nut (shown in Photo 2-11) to gain clearance for the carriage bolt and nut. After adding the bolt and nut, securely tighten the bumper nut.

G. Using a 7/16" wrench, tighten all four carriage bolts securely.

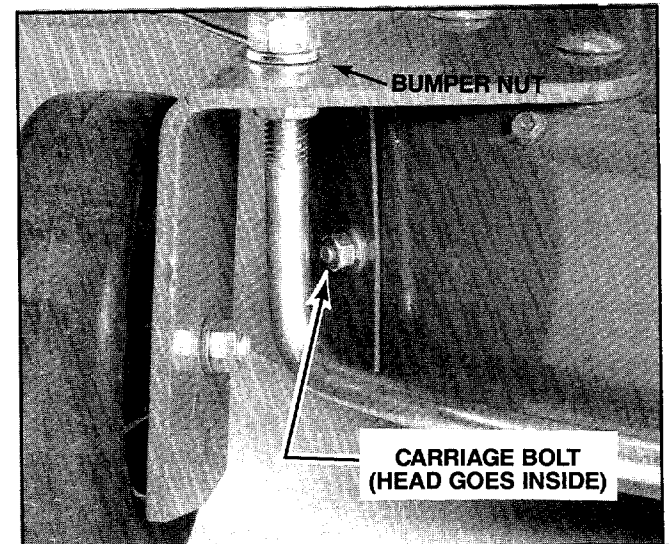



Photo 2-11: Location of fourth carriage bolt.

STEP 6: Add Oil to Engine Crankcase

 **CAUTION:** The engine was shipped to you "dry", and oil must be added to the crankcase before the engine is started to avoid damaging the engine.

A. Make sure that the engine is level.

B. Use a high quality detergent oil classified "For Service: SE, SF, or SG." Above 40°F, use SAE 30. From 0° to 40°F, use 5W-30 or 10W-30. (See the engine owner's pamphlet for synthetic oil recommendations.) No special additives should be added to the oil. **DO NOT MIX OIL WITH GASOLINE.**

C. The 5HP engine (22" mower) requires approximately 20 ounces; the 8HP engine (24" mower) requires approximately 36 ounces.

D. Clean the area around the oil fill hole before removing the oil fill plug or dipstick.

IMPORTANT: Always stop engine before adding oil.

E. 8 HP ENGINE: Remove the dipstick by rotating it counterclockwise. See Photo 2-12. Using a clean funnel, slowly pour oil into the filler neck. While adding oil, frequently check the level by replacing the dipstick and rotating the cap until it is secure. Then remove the dipstick and check the oil level by reading the dipstick markings (wipe the dipstick with a clean rag each time before replacing it). Stop adding oil when the level reaches the FULL mark. Do not overfill. **ALWAYS MAINTAIN THE OIL LEVEL AT THE FULL MARK ON THE DIPSTICK.**

F. 5 HP ENGINE: Remove the oil fill cap by rotating it counterclockwise. See Photo 2-13. Using a clean funnel, slowly add oil until it reaches the point of overflowing at the oil fill hole. **ALWAYS MAINTAIN THE OIL LEVEL AT THE POINT OF OVERFLOWING.**

G. After adding oil, securely replace the oil fill cap or the dipstick.

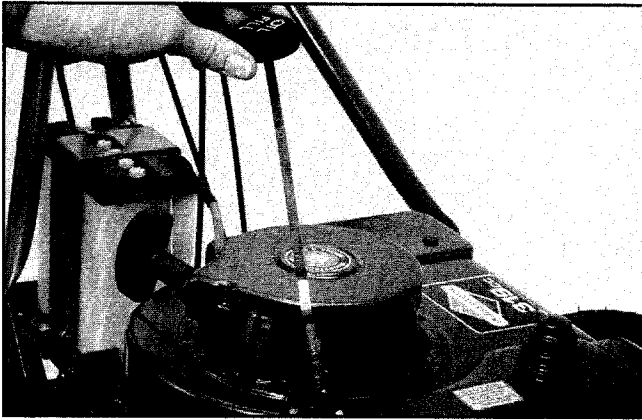

Photo 2-12: Oil fill hole on 8 HP engine.

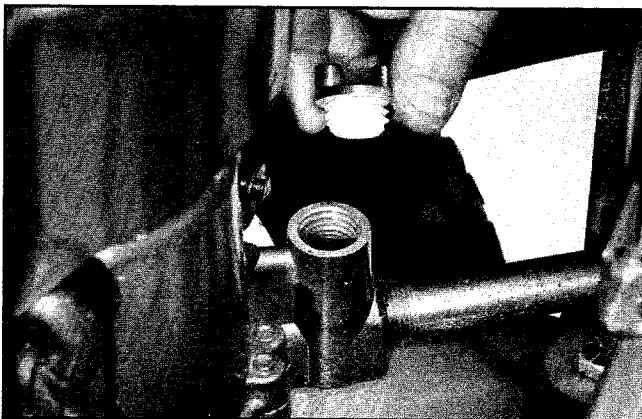

Photo 2-13: Oil fill hole on 5 HP engine.

IMPORTANT

- Check the oil level each time before starting the engine and after each 5 hours of continuous operation.
- Change the oil after the first 5 operating hours and every 25 hours thereafter. Change the oil more frequently in extremely dusty or dirty conditions.
- Clean the air cleaner after every 25 operating hours, or sooner under extremely dusty or dirty operating conditions.

STEP 7: Attach Engine Throttle Control

A. Parts Needed: (1) 1/4"-20 x 1 1/2" long Hex Hd. Screw, (1) 1/4" Lockwasher, (1) 1/4"-20 Hex Nut, (1) Plastic Tie (for 24" Mower Only).

B. Uncoil the throttle cable and position the throttle control on the inside edge of the left handlebar as shown in Photo 2-14.

NOTE: On the 22" mower (5 HP engine) the throttle cable should be routed above the tubular frame crosspiece located behind the engine; on the 24" mower (8 HP engine) the cable should be below the crosspiece. See Photo 2-15.

C. Insert a 1 1/2" long screw through the handlebar and into the metal clamp that is attached to the throttle control. Add a 1/4" lockwasher and hex nut and tighten securely using two 7/16" wrenches.

D. On the 24" mower only, use a plastic tie to secure the throttle control cable and the blade control cable (the thick, black cable that is attached to the blade drive control on the left handlebar) to the center handlebar brace. Locate the tie approximately in the middle of the center brace.

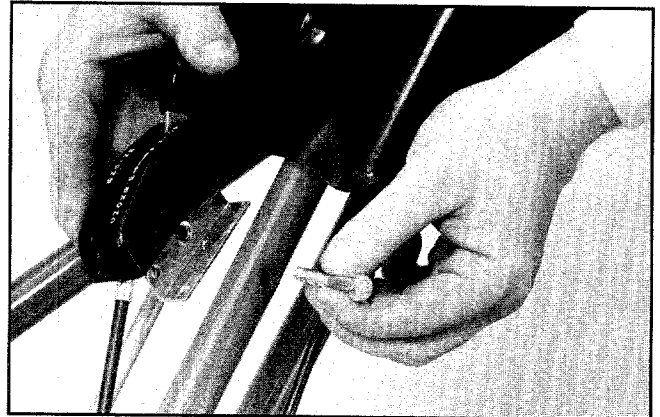

Photo 2-14: Install engine throttle control.

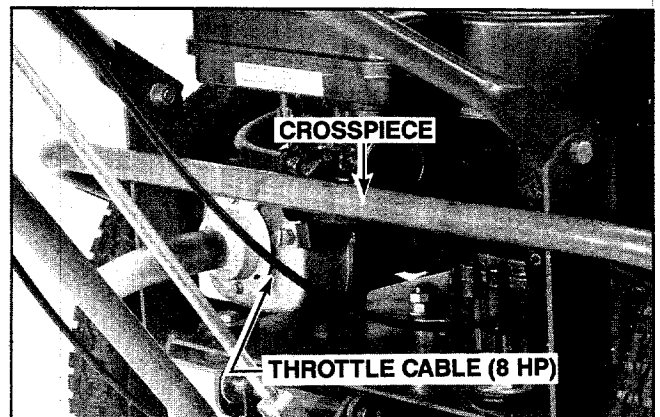

Photo 2-15: Throttle cable goes below crosspiece on 8 HP engine (as shown above), and above crosspiece on 5 HP engine.

IMPORTANT

This completes the mower assembly steps if you have a recoil (rope pull) starting engine. If you have an electric (key switch) starting engine, please continue with the following electric start assembly steps.



CAUTION: To avoid personal injury, carefully read and follow all of the Safety, Controls, and Operating instructions in this manual and in the separate engine owner's pamphlet before attempting to start the engine or operate the mower.

ELECTRIC START ASSEMBLY STEPS:

IMPORTANT

Your new battery must be activated with electrolyte and fully charged before placing it in service.

The optional electric start system includes a 12-volt side-vented battery, a key switch ignition system, a solenoid, a starter motor (attached to the engine), and the cables and wires that connect the electrical system. A built-in recharging circuit automatically recharges the battery during mower operation.

The following steps explain how to activate and charge the battery, and how to assemble the electric start system. For your safety, please follow each step carefully and observe all of the accompanying Safety Warnings and Cautions.

DANGER — POISON - CAUSES SEVERE BURNS!

- Electrolyte is a sulfuric acid solution.
- Avoid contact with skin, eyes or clothing.
- To prevent accidents and avoid personal injury, wear protective clothing, rubber gloves, and shield eyes with safety goggles.
- Neutralize acid spills with baking soda and water solution. Neutralize empty container with baking soda and rinse with water.

ANTIDOTE: External — Flush with water. Eyes — Flush with water for 15 minutes and get prompt medical attention.

ANTIDOTE: Internal — Drink large quantities of water or milk. Follow with milk of magnesia, beaten eggs, or vegetable oil. Call physician immediately.

KEEP OUT OF REACH OF CHILDREN.

DANGER — BATTERIES PRODUCE EXPLOSIVE GASES!

- Keep sparks, flame, cigarettes away.
- Ventilate area when charging or using battery in enclosed space.
- Make sure venting path of battery is always open once battery is filled with acid.

STEP 1: Activate and Charge the Battery

A. The battery is shipped to you “dry”, and it cannot be used until it has been activated with electrolyte (battery grade sulfuric acid) and given a proper start-up charge. Activating a battery with electrolyte is dangerous work (the acid can eat through clothing and burn skin) and we therefore strongly recommend that you take the battery to a reliable service station, battery store, or farm/outdoor power equipment center where a trained battery technician can complete the job safely. **PLEASE DO NOT ATTEMPT TO ACTIVATE THE BATTERY YOURSELF UNLESS YOU ARE FULLY EXPERIENCED IN BATTERY SERVICE WORK!**

B. There may be a sealed plastic tube covering the vent fitting on the positive (+) side of the battery. Be sure to remove and discard this tube before activating the battery. See Photo 2-16.

C. Place battery on level surface and remove all filler caps. Leave caps off during filling and charging procedures.

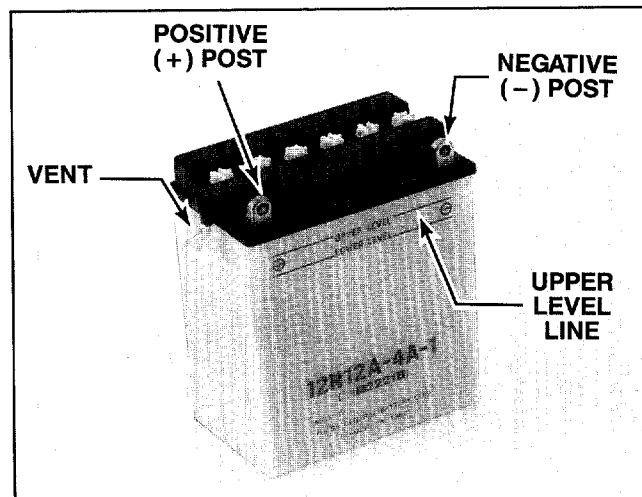



Photo 2-16: Add electrolyte to UPPER LEVEL line.

 **WARNING:** Remove metal jewelry before working near the battery or any part of the electrical system. Failure to do so can cause a short circuit that could result in electrical burns, an electrical shock, or an explosion of battery gases.

D. Carefully fill the cells with battery grade electrolyte (1.265 Specific Gravity sulfuric acid) until it reaches the UPPER LEVEL LINE that is marked on the outside of the battery case. See Photo 2-16. The temperature of the battery and the electrolyte should be between 60°F to 80°F for best results. No water or other liquid should be added to the battery during this initial activation.

E. Allow the battery to stand for 30 minutes. Then check each cell and, if necessary, add more electrolyte until it reaches the UPPER LEVEL LINE. **DO NOT** overfill with electrolyte as this may cause electrolyte to flood over during battery charging.

DANGER

- Batteries generate explosive gases. Keep sparks and flames away from battery at all times.
- Ventilate area when charging or using battery in enclosed space.
- We recommend that the battery not be left on charge while unattended (the charging time need not be continuous).
- Carefully follow charging instructions and Safety Rules provided by the manufacturer of the charging equipment being used.

F. To obtain maximum starting capacity and longest life, the battery must be fully charged at a rate of 1 to 2 amperes until all cells are gassing freely. (To determine this, WEAR SAFETY GOGGLES and use a flashlight to look down into each cell while the battery is being charged. When gassing freely, the surface of the liquid electrolyte should be covered with tiny bubbles). The total charging time should not exceed 12 hours.



CAUTION: Do not charge the battery at a rate higher than 1 to 2 amperes. Higher amperages can generate excessive heat and gassing, permanently damaging the battery.

G. When the battery is fully charged, turn off the charger and then disconnect the cables. Check the electrolyte levels, and if necessary add distilled or demineralized water until it just reaches the UPPER LEVEL LINE.

H. Replace the filler caps and use a baking soda and water solution to wash off any electrolyte which may have spilled on the battery.

IMPORTANT

When the battery will not be used for extended periods (such as during the winter months), the following charging schedule should be followed:

- a. Charge the battery before prolonged storage.
- b. Charge the battery after prolonged storage.

Please refer to Section 5 of this manual for battery maintenance and recharging instructions.

STEP 2: Install Battery Mounting Bracket

A. Parts Needed: (2) 1/4"-20 x 1 1/4" long Hex Hd. Screws, (2) 1/4"-20" Locknuts, (1) Battery Mounting Bracket.

B. The battery mounting bracket must be attached to the mower's frame and engine mounting platform at the three locations shown in Photo 2-17.

C. Using two 9/16" wrenches, remove the 1 7/8" long hex hd. screw, 3/8" lockwasher, and 3/8" hex nut from the right side of the engine mounting platform. See Photo 2-17. Save this hardware.

D. Align the two holes in the top, front of the mounting bracket with the two holes in the mower frame cross-piece. Insert the two 1 1/4" long screws down through the bracket and frame and loosely attach the two 1/4" locknuts.

E. Align the hole at the bottom of the battery bracket support leg with the hole in the bottom of the engine mounting platform (leg goes below platform). Replace the 1 7/8" long screw, add the lockwasher and nut, and tighten securely.

F. Now return to the two upper mounting screws and tighten them securely using two 7/16" wrenches.

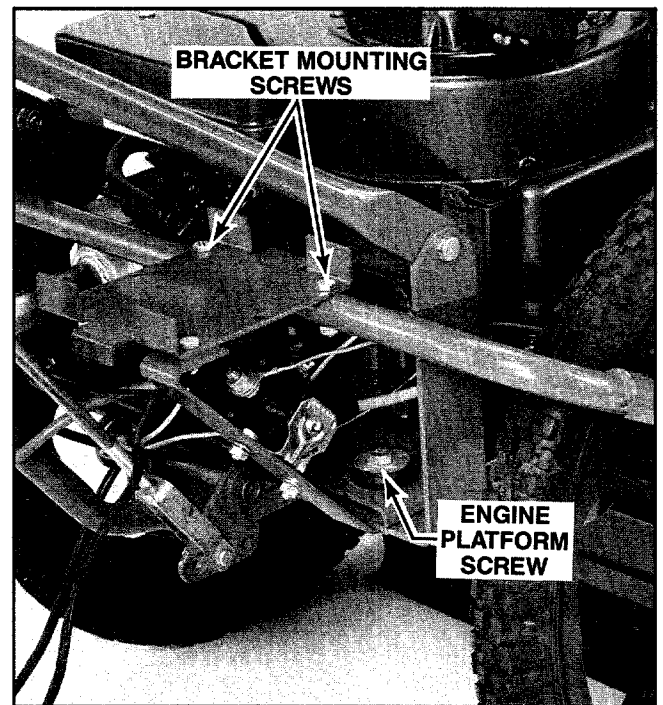

Photo 2-17: Install battery mounting bracket.

STEP 3: Connect Battery Recharging Line

A. Parts Needed: (1) Plastic tie.

B. The battery recharging line is a thin red wire, approximately 12" long. One end is already connected to the upper stud on the solenoid (the solenoid is a black, can-like device that is mounted on the battery bracket support leg). On the unattached end of the line there is a white plastic bayonet terminal.

C. Bring the recharging line over to the right side of the engine and plug the white terminal into the red terminal that is attached to the engine with black wires. Push the terminals firmly together. See Photo 2-18 or 2-19.

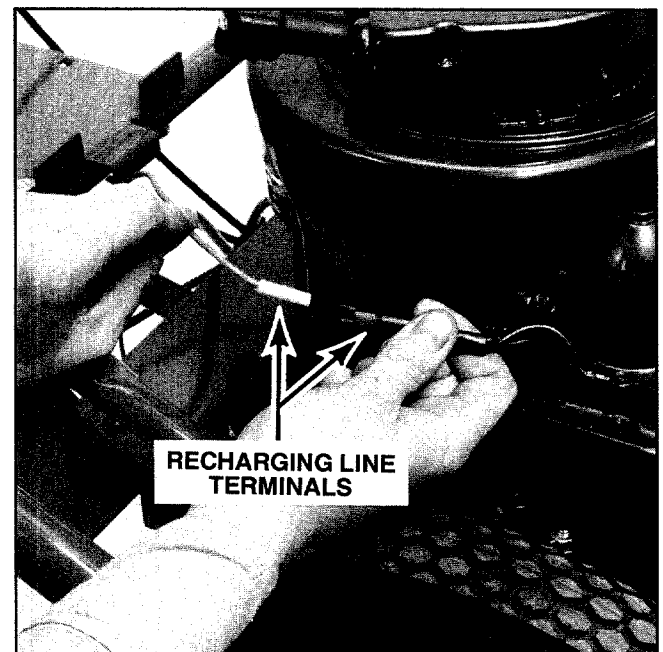

Photo 2-18: Connect recharging line on 22" (5HP) engine mower.

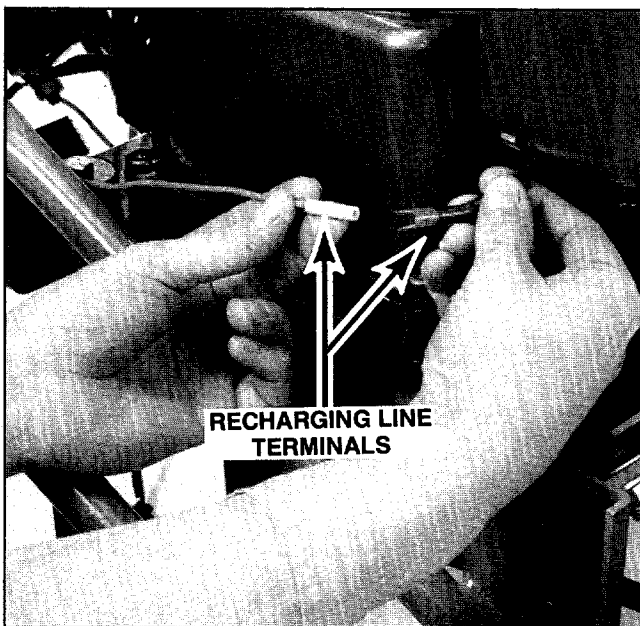

Photo 2-19: Connect recharging line on 24" (8HP engine) mower. (Wheel removed for photo clarity).

D. Use a plastic tie to secure the recharging line to the strut. See Photo 2-20.

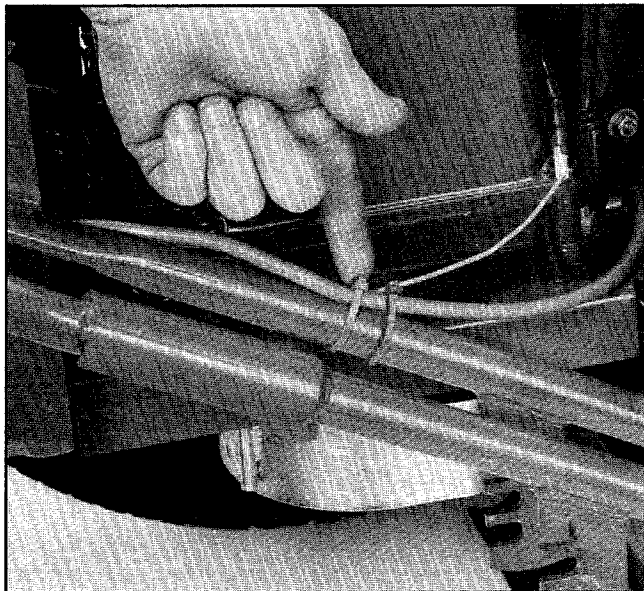

Photo 2-20: Add plastic tie to recharging line (wheel removed for clarity).

STEP 4: Attach Starter Motor Cable

A. Parts Needed: (1) 5/16"-24 Hex Nut, (1) 5/16" Lockwasher.

B. The starter motor cable is a thick red cable, approximately 20" long. One end is already attached to the starter motor at the front, right side of the engine.

C. Bring the cable terminal over to the solenoid that is mounted on the battery bracket support leg. As shown in Photo 2-21, attach the cable terminal to the lower stud on the solenoid and add the 5/16" lockwasher and 5/16" hex nut. Tighten the hex nut securely to ensure a good electrical contact.

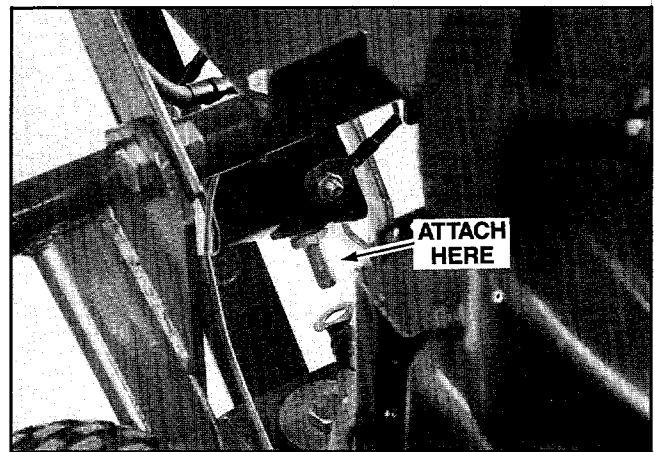

Photo 2-21: Attach starter motor cable to lower stud on solenoid.

STEP 5: Attach Ignition Ground Wire

A. The ignition ground wire is a thin green wire that leads from the key switch wiring harness (the wiring harness also contains a red and a white wire).

B. At the rear of the engine, remove the nut from the engine ground stud, attach the wire terminal, and replace the nut securely. See Photo 2-22 or 2-23.

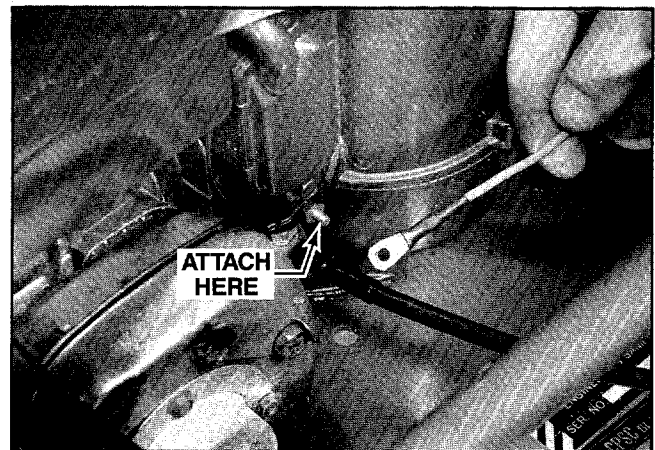

Photo 2-22: Attach ignition ground wire on 22" (5HP engine) mower.

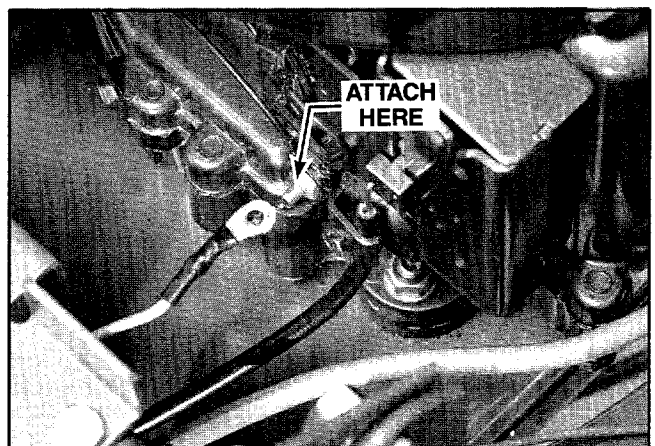

Photo 2-23: Attach ignition ground wire on 24" (8HP engine) mower.

STEP 6: Attach Vent Tube to Battery

A. Parts Needed: (1) Vent Tube (shipped in battery carton).

B. Attach the long, clear plastic vent tube over the vent fitting on the positive (+) side of the battery. See Photo 2-24.



Photo 2-24: Attach vent tube to battery.

STEP 7: Install Battery and Hold-Down Clamp

A. Parts Needed: (1) Hold-Down Clamp, (2) 1/4"-20 x 1" long Hex Hd. Screws, (2) 1/4"-20 Locknuts.

B. Place the battery on the mounting bracket exactly as shown in Photo 2-25. Make sure that the positive (+) post on the battery is facing the engine.

C. Run the plastic vent tube straight down the side of the battery so that the end is pointing toward the ground.

D. Position the hold-down clamp over the battery exactly as shown in Photo 2-25, making sure that the large hole in one side of the clamp is on the left side of the battery.

E. Fasten the two sides of the clamp to the bracket by inserting the two 1" long screws up through the mounting holes. Add 1/4" locknuts and tighten securely using two 7/16" wrenches. The clamp should be tight enough to prevent the battery from moving, but do not overtighten the screws, which would bend the tabs on the clamp.

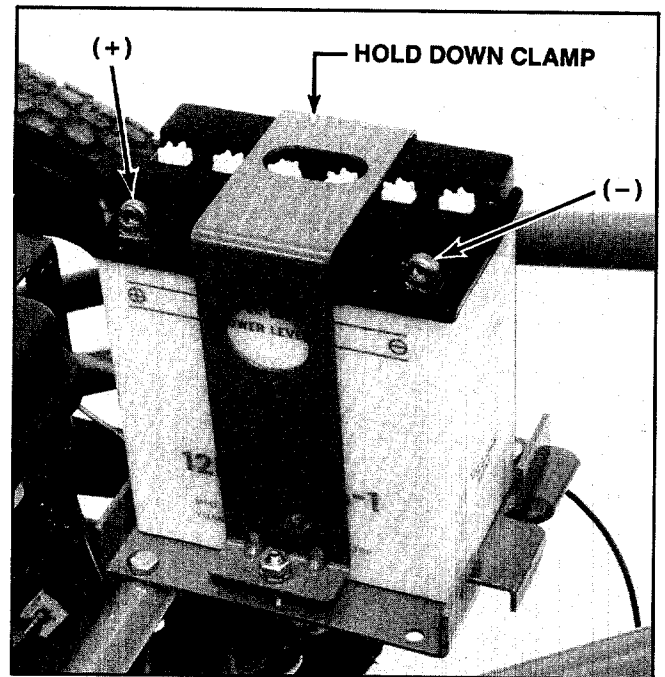

Photo 2-25: Install battery and hold-down clamp.

STEP 8: Attach Positive (+) Battery Cable

A. Parts Needed: (1) 1/4"-20 x 1/2" long Battery Bolt, (1) 1/4"-20 Hex Nut (shipped in battery carton). Note: Battery bolts and nuts are metric sizes. The sizes given above are in U.S. size equivalents.

B. The positive (+) battery cable is a thick red cable, approximately 14" long. One end is already attached to the upper stud on the solenoid. There is a rubber insulating boot located on the cable.

C. Place the battery nut on the inside of the battery positive (+) post and the cable terminal on the outside of the post. Install the battery bolt securely using a philips head screwdriver. See Photo 2-26.

D. Slide the rubber boot over the battery post, making sure that it covers the post completely. If necessary, use a screwdriver with a wide, flat tip to help seat the boot between the battery nut and the battery case.

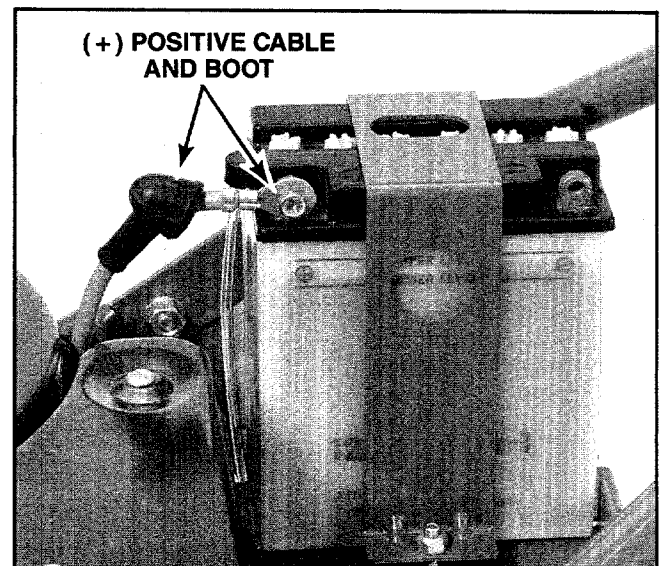

Photo 2-26: Attach positive (+) battery cable.

WARNING

- Do not touch the positive (+) battery post and any other surrounding metal with tools, jewelry, or other metal objects. Doing so can cause a short circuit that could result in electrical burns, an electrical shock, or an explosion of battery gases.
- Install the battery exactly as shown in Photo 2-25. If the battery is installed in reverse, the battery and other electrical system parts will be damaged.
- Make certain that the vent tube is not crimped, pinched, or folded anywhere along its length. Improper venting could result in a battery explosion.

STEP 9: Attach Negative (-) Ground Wire and Negative (-) Battery Cable

A. Parts Needed: (1) ¼"-20 x ½" long Battery Bolt, (1) ¼"-20 Hex Nut (shipped in battery carton).

B. The negative (-) ground wire is a thin black wire, approximately 11" long. One end is already connected to the upper bolt that secures the solenoid to the battery bracket support leg.

C. The negative (-) battery cable is a thick black cable, approximately 22" long. One end is already connected to the engine mounting screw on the left side, rear of the engine.

D. Place the battery nut on the inside of the battery negative (-) post and position the wire and cable terminals on the outside of the post. Install the battery bolt securely using a phillips head screwdriver. See Photo 2-27.

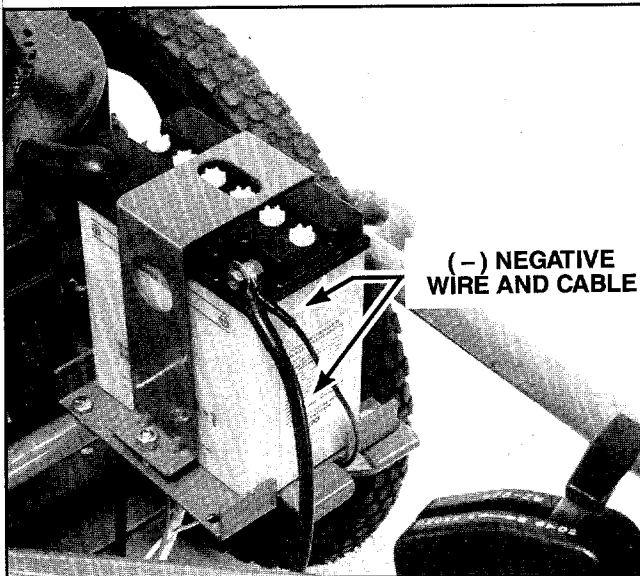

Photo 2-27: Attach negative (-) wire and cable.

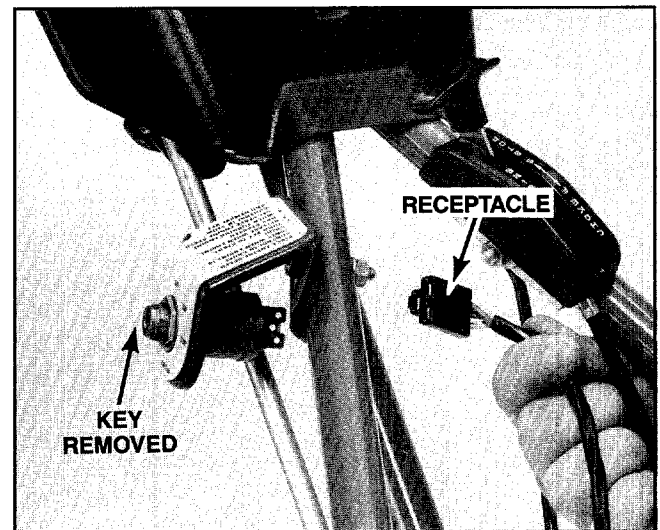

Photo 2-28: Connect receptacle to key switch.

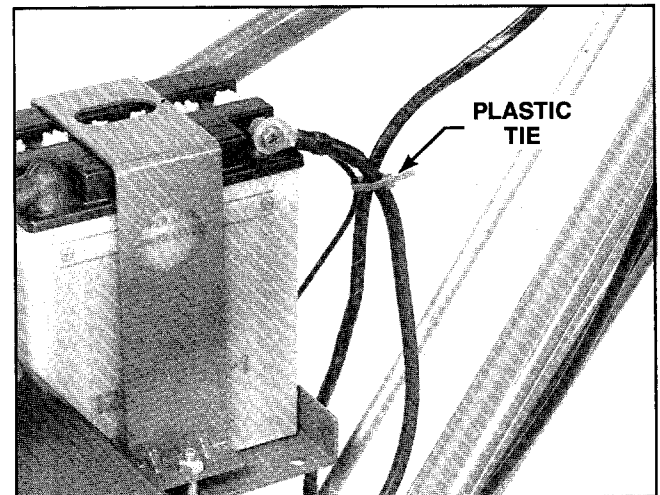

Photo 2-29: Secure wire, cable and harness with tie.

STEP 10: Connect Wire Harness Receptacle to Key Switch



CAUTION: Remove the ignition key from the key switch before connecting the wire harness receptacle to the switch.

A. Parts Needed: (1) Plastic Tie.

B. Connect the wire harness receptacle (which has three wires leading out of it) to the bottom of the key switch assembly. See Photo 2-28. Make certain that the connection is good and tight.

C. Use a plastic tie to secure the wire harness to the negative (-) ground wire and negative battery cable as shown in Photo 2-29.

D. Do not replace the ignition key in the key switch until you have read all of the Safety, Controls and Operating instructions in this manual and in the separate engine owner's pamphlet.



WARNING

- Never bring a gasoline can near the battery posts. A short circuit caused by touching the positive (+) post and any metal could cause an explosion of the gasoline or of battery gases.
- Never attempt to "jump start" the battery with an automobile battery or its charging system. Doing so could result in serious personal injury or property damage from such causes as a battery explosion, or acid or electrical burns.
- To avoid personal injury, always remove the key from the switch, disconnect the spark plug wire, and keep the wire away from the spark plug when leaving the mower unattended or when the mower is not in use.
- To avoid personal injury when servicing the mower or engine, always remove the spark plug wire from the spark plug and keep the wire away from the plug. Then disconnect the negative (-) cable from the battery post and bend it safely away from the battery post.

SECTION 3

Mower and Engine Controls

Before operating your mower, familiarize yourself with all mower and engine controls. Taking the time now to understand fully the location, function, and operation of these controls will greatly increase your ability to operate your mower efficiently and safely.

IMPORTANT

This mower is equipped with a blade brake which is designed to stop the mower blade within three seconds after release of the blade control handle. This feature is required to meet the federally mandated safety standards described in Section 1 of this Manual. Never tamper with, or attempt to defeat the purpose of this safety device. Doing so may result in personal injury through contact with the rotating blade. Check that the Blade Brake Control System is operating properly. See the Blade Brake Control Test Procedure described on Page 34.

MOWER CONTROLS

NOTE: All references to "Left" and "Right" are given from the operator's position behind the handlebars.

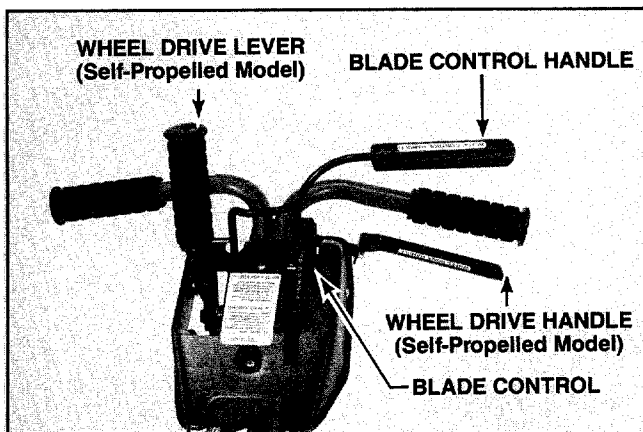

Photo 3-1: Location of mower controls.

BLADE DRIVE CONTROLS

The blade control handle and blade control are located on the left handlebar of your mower. See Photo 3-1. These controls are used to engage and disengage the mower blade.

To engage the blade drive mechanism, first pull the blade control handle down and hold it against the handlebar grip. Then, set the blade control by pushing the control forward until a distinct "click" is heard. See Photo 3-2. This action tightens the blade drive belt, allowing the blade to begin rotating. It also resets a friction brake mechanism located on the blade spindle which will stop the blade within three seconds after you release the blade control handle.

The blade control handle must be depressed against the handlebar grip in order to keep the blade rotating. Releasing the blade control handle will disengage the blade control and stop the blade within the three second safety limit.

Because the blade brake system stops the blade but not the engine, you can disengage the blade drive at anytime without having to stop and then restart the engine. This feature is particularly useful when you need to cross gravel drives or rough terrain and you do not want the rotating blade to throw stones or strike hidden obstacles.

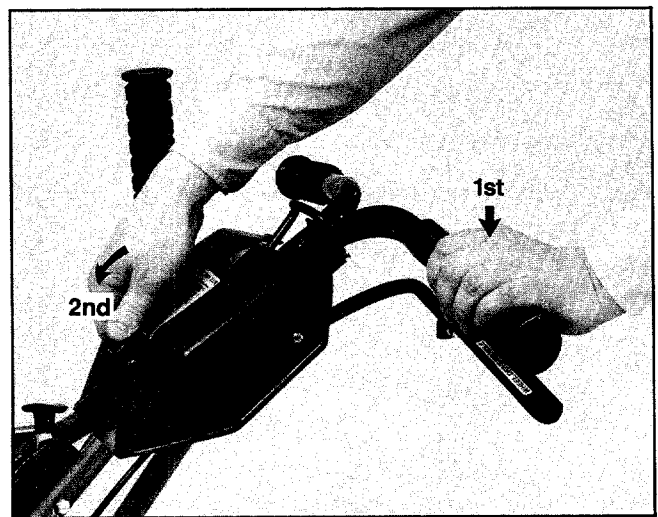

Photo 3-2: Operation of blade control handle and blade control.

CAUTION: When starting the engine, the blade control handle should be in the fully released position. This position ensures that the blade will not start rotating when the engine starts. To avoid personal injury, do not engage the blade drive controls until you are ready to begin mowing.

WARNING: If the blade brake system is damaged or maladjusted, the blade may continue to rotate after you have released the blade control handle. If the blade does not stop within 3 seconds of release of the blade control handle, move the engine throttle control to the STOP position. Immediately refer to the Blade Brake Control System Test Procedure on Page 34. To avoid personal injury, do not operate the mower until the Blade Brake Control System is operating properly.

WHEEL DRIVE CONTROLS (Self-Propelled Models Only)

The wheel drive handle is located below the left side handlebar grip and the wheel drive lever is located toward the right side of the handlebars. See Photo 3-1. These controls are used to engage and disengage traction drive to the wheels on self-propelled models.

To engage the wheel drive mechanism, first pull the wheel drive handle up and hold it against the handlebar grip. Then, push the wheel drive lever all the way forward until it latches in the forward position. See Photo 3-3. This action pulls back the lower wheel drive control rod which is connected to the wheel friction drive rollers. The rollers then push against the wheels to propel the mower forward.

The wheel drive handle must be depressed against the handlebar grip in order to keep the wheels turning. Releasing the wheel drive handle will disengage the wheel drive lever, which then disengages the rollers from the wheels.

For trimming or maneuvering in tight places, you can disengage the wheel drive (by releasing the wheel drive handle), and then "creep" the mower forward by gradually pushing the wheel drive lever forward until the wheel friction drive rollers contact the wheels. To stop the forward motion, simply pull back on the wheel drive lever.

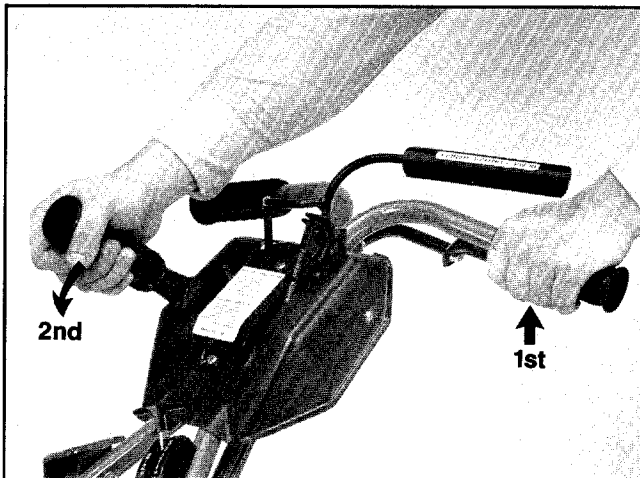

Photo 3-3: Operation of wheel drive handle and wheel drive lever.

CAUTION: When starting the engine, the wheel drive lever should be in the upward, NEUTRAL position. This position ensures that the wheels will not start turning when the engine starts. To avoid personal injury, do not engage the wheel drive lever until you are ready to move the mower.

HANDLEBAR HEIGHT ADJUSTMENT

The handlebars can be adjusted to any of three different height settings: LOW, MEDIUM and HIGH.

To change the handlebar height, refer to the "Handlebar Height Adjustment" instructions found in Section 5.

HEIGHT OF CUT ADJUSTMENT

The cutting height can be adjusted to any of four different settings: 1-5/8", 2-1/4", 2-7/8", and 3-1/2".

The cutting height has been set at the factory at the 2-7/8" setting. This cutting height is recommended for initial mowing in rough terrain as it will minimize the chances of the blade hitting rocks or other hidden obstructions (see CAUTION statement below).

To change the cutting height to a higher or lower setting, refer to the "Height of Cut Adjustment" instructions in Section 5.

CAUTION: Before mowing, thoroughly inspect the area where the mower is to be used and remove all stones, sticks, wires, bones, nails and other foreign objects, to prevent personal injury caused by thrown objects.

ENGINE CONTROLS

The following are descriptions of the controls of your 5 HP or 8 HP Briggs & Stratton Engine. Additional information on the safe, efficient operation of your engine is given in the engine owner's pamphlet which was included in your mower literature package. Please read that pamphlet carefully.

CAUTION: To avoid personal injury, do not attempt to start your engine at this time. Complete starting instructions for your mower are provided in Section 4, "Operating Instructions."

ENGINE THROTTLE CONTROL

On all models, the engine throttle control is located on the left handlebar. See Photo 3-4. This control operates a full range of engine speeds. It also activates the engine choke control when starting the engine, and stops the engine by grounding out the ignition.

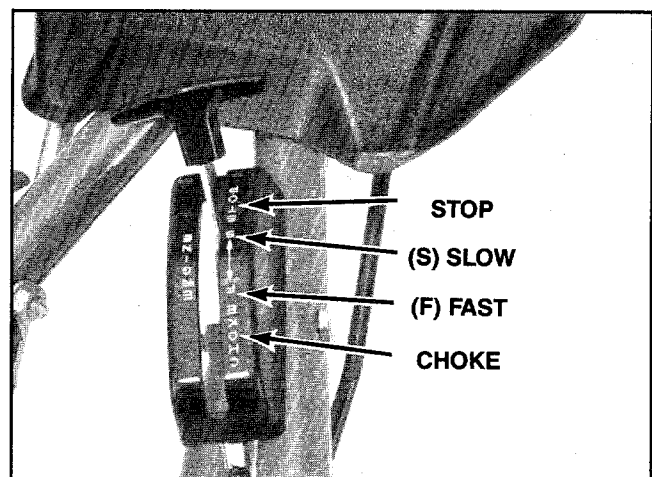

Photo 3-4: Engine throttle control settings.

There are three operating positions identified on the throttle control: CHOKE, F-S (Fast-Slow), and STOP. The Fast and Slow settings are provided with detent type stops that "catch" the lever when those settings are engaged. To move the lever out of the detent stops, push the lever a short distance to the right.

Before starting the engine, always make sure that the blade drive and wheel drive controls are disengaged. Then, move the throttle lever all the way forward (past the Fast detent stop) to the CHOKE position. As soon as the engine starts, gradually pull the lever back to the Slow detent stop. Do not leave the throttle in the choke position. Doing so could harm your engine.

NOTE: A warm engine requires less choking than a cold engine.

Once the engine is sufficiently warm, move the lever to the desired engine speed for your particular mowing task. The engine is designed to be operated at full speed to give you the best cut and fastest traction drive (on self-propelled models). However, if preferred, slower speeds can be used.

To stop the engine, release the blade and wheel drive control handles, put the engine throttle lever in the Slow position, and then pull the throttle lever all the way back to the STOP position.

FUEL SHUT-OFF VALVE (8 HP Engine Only)

The 8 HP (24" mower) engine is equipped with a fuel shut-off valve. The valve is located on the back of the engine below the air cleaner assembly. See Photo 3-5.

To shut off the fuel flow to the carburetor, turn the valve clockwise until it stops turning. To open, turn the valve counterclockwise several turns. Always remember to open the fuel valve before attempting to start the engine.

NOTE: Close the fuel shut-off valve when the engine is transported to prevent fuel leakage.

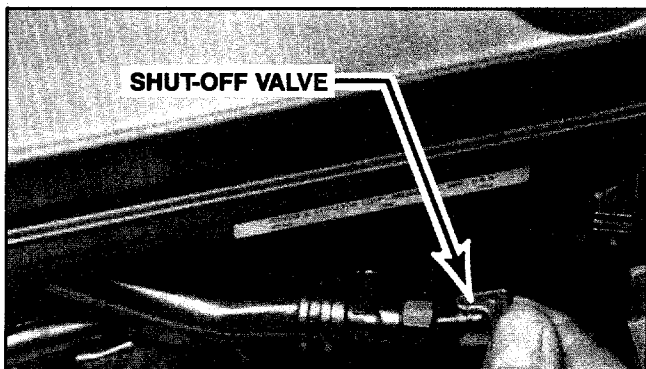

Photo 3-5: Fuel shut-off valve (8 HP engine).

ENGINE RECOIL STARTER

On all models, the recoil starter rope handle is located on top of the engine, on the right side as viewed from the operator's position behind the handlebars. See Photo 3-6.

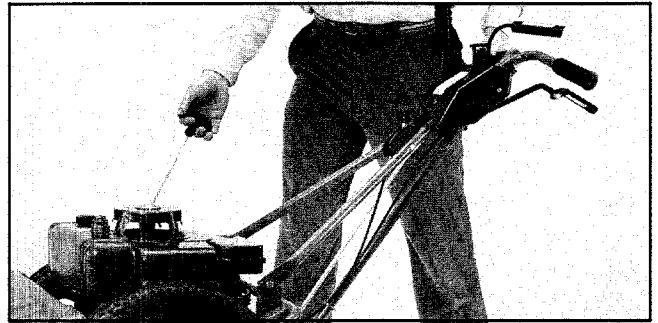

Photo 3-6: Engine recoil starter rope (5 HP engine shown).

To start the engine, first place your left hand on the right side handlebar grip to help stabilize the mower. Then grasp the starter rope handle with your right hand and pull the rope out slowly until it is harder to pull because of engine compression. Next, pull the rope with a rapid, continuous, full-arm stroke. Do not let the starter rope snap back against the rope guide. Let the rope rewind slowly.

KEY SWITCH STARTER (Electric Start Engine Only)

The key switch starter for electric start engines is located on the right handlebar. See Photo 3-7. There are three operating positions identified on the switch: OFF, RUN, and START.

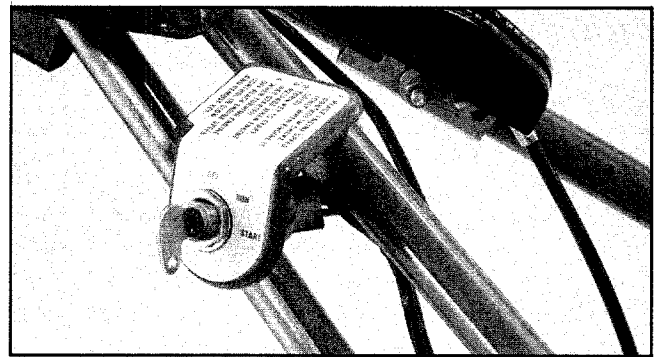

Photo 3-7: Key switch starter

To start the engine, first insert the key firmly into the slot. Then, turn the key to the START position. Do not hold the key in the start position for longer than a few seconds. Prolonged cranking can damage the starter motor if cranked more than 15 seconds per minute.

When the engine starts, release the key and it will automatically return to the RUN position.

There are two ways to stop the electric start engine:

1. Release the blade control and wheel drive handles, put the engine throttle lever in the SLOW position, and then pull the throttle lever all the way back to the STOP position. Turn the key to the OFF position and remove the key.
2. Release the blade control and wheel drive handles, then put the engine throttle lever in the SLOW position. Turn the key to the OFF position and remove the key.

SECTION 4

Operating Instructions

Your TUFF-CUT Mower is very easy to operate and in this Section you will find not only detailed operating instructions, but also tips and suggestions to help you get the greatest possible satisfaction from your mower. Please read this Section thoroughly before you attempt to start the engine. Then, find a clear area where you can safely learn to start, stop and maneuver your mower.

IMPORTANT

Before operating your mower, be sure that you have carefully read and fully understand the "Rules for Safe Operation" given in Section 1 of this manual, in addition to those presented in this Section.

PREPARATION BEFORE STARTING

A. CHECK ENGINE OIL LEVEL. Check the oil level in the engine crankcase. Do not run the engine unless the proper oil level is maintained. Refer to Section 2 for instructions.

IMPORTANT

Check oil level before each use and after each five hours of continuous operation. Change oil after first five operating hours and every 25 operating hours thereafter.

B. FILL FUEL TANK

1. Remove fuel tank cap and check fuel level (see Photo 4-1 or 4-2). Clean area around fuel cap before removing to prevent the entrance of dust, dirt and moisture.

2. Use clean, fresh, lead-free, automotive gasoline. Leaded gasoline may be used if lead-free is not available. (The use of lead-free gasoline results in fewer combustion deposits and longer valve life.) A minimum of 77 octane is recommended. **DO NOT MIX OIL WITH GASOLINE.**



Photo 4-2: Fuel tank on 8HP engine (24" mower).

3. Do not fill the fuel tank to the point of overflowing. Fill to within 1/2" of top of fuel tank to prevent spills and to allow for fuel expansion. The fuel tank capacity is 2 quarts on the 5HP engine and 3 quarts on the 8HP engine.

4. Replace the fuel cap securely before starting the engine.



DANGER: Gasoline is highly flammable and its vapors are explosive. Handle with extreme care. Never fill tank when engine is running or still hot from operation. Do not allow open flame, matches or smoking in area. Do not fill tank indoors or in poorly ventilated area. Wipe any spills and move mower away from gasoline fumes before starting engine. Use an approved container.

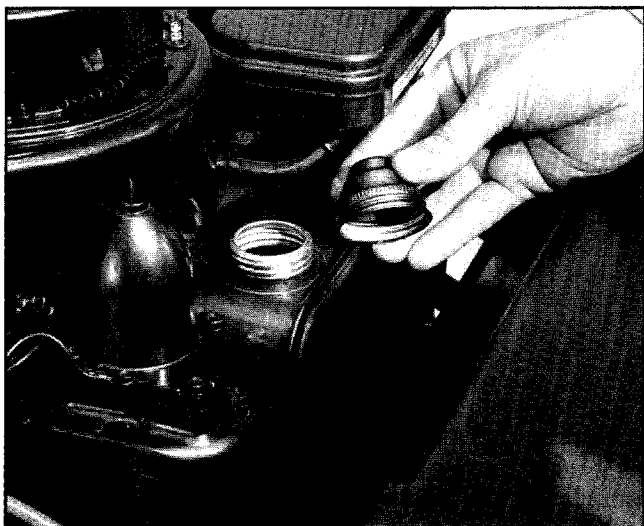

Photo 4-1: Fuel tank on 5HP engine (22" mower).

C. CHECK AIR CLEANER. Check the cleanliness of the oil foam air cleaner and service it if necessary. Refer to the engine owner's pamphlet for instructions.

D. CHECK NUTS AND BOLTS FOR TIGHTNESS. Check all nuts and bolts for tightness and keep them tightened securely at all times.

E. CHECK TIRE PRESSURE. Make sure that the rear tires are inflated equally to between 25-30 psi.

F. CHECK CUTTING HEIGHT. Check that the wheels are adjusted for the desired cutting height as described in Section 5.

G. ATTACH SPARK PLUG. Be sure that the spark plug wire is securely attached to the spark plug.

H. CHECK BATTERY (Electric Start Models). Check that the battery is properly filled and that all electrical connections are clean and tight. Refer to Section 5 for instructions.

IMPORTANT

At the start of each season and after every 10 operating hours, perform the Blade Brake Control Test Procedure described on Page 34.

TO START THE ENGINE

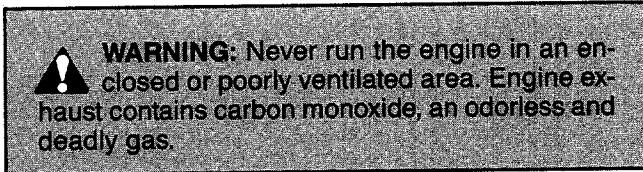

A. Be certain that the blade control handle and the wheel drive handle (on self-propelled models) are in the disengaged (released) position. See Photo 4-3.

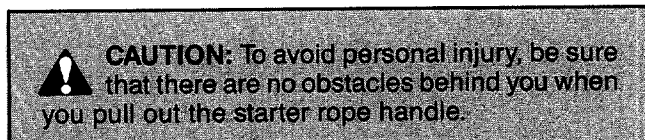

Photo 4-3: Release blade control and wheel drive handles before starting engine.

B. On 8HP engines (24" mower), open the fuel shut-off valve.

C. Set the engine throttle lever at the CHOKE position. **NOTE:** A warm engine requires less choking than a cold engine.

D. For recoil start engines, place your left hand on the right side handlebar grip to help stabilize the mower. Then grasp the starter rope handle with your right hand and pull the rope out slowly until it is harder to pull because of engine compression. Next, pull the rope with a rapid, continuous, full-arm stroke. Do not let the starter rope snap back against the rope guide. Let the rope rewind slowly.



E. For electric start engines, turn the key switch to the START position. Do not hold the key in the start position

for longer than a few seconds. Prolonged cranking can damage the starter motor if cranked more than 15 seconds per minute. Release the key when the engine starts.

NOTE: If necessary, the electric start engine can be started with the recoil starter rope. See Section 5 for detailed instructions.

F. If your engine does not start in four or five tries, let the engine set for 10 minutes and then repeat the starting procedure.

G. As soon as the engine starts, move the engine throttle lever gradually to the SLOW (S) setting and allow the engine to warm up. Then, move the lever to the desired speed for your mowing task.

IMPORTANT

Do not leave the throttle lever in the CHOKE position. Doing so could harm your engine.

TO ENGAGE THE BLADE

A. When you are ready to begin mowing, first pull the blade control handle down and hold it against the handlebar grip. Then push the blade control forward until a distinct "click" is heard. See Photo 4-4.



Photo 4-4: To engage the blade drive.

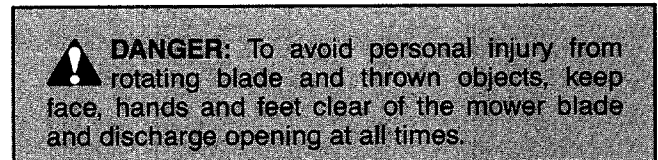

B. Increase or decrease the engine speed to adjust the blade speed. For best cutting results, the blade should be operated with the engine at full or nearly full throttle.

C. TO STOP THE BLADE, release the blade control handle completely from its position against the handlebar grip.

IMPORTANT

At the start of each season and after every 10 operating hours, perform the Blade Brake Control Test Procedure described on Page 34.

CAUTION: To avoid personal injury, disengage the cutting blade before crossing gravel drives, roads, or sidewalks to prevent the blade from throwing stones or other hazardous objects.

TO ENGAGE THE WHEELS (Self-Propelled Models Only)

A. Pull the wheel drive handle up and hold it against the handlebar grip. Then push the wheel drive lever forward until it latches in the forward position. See Photo 4-5.

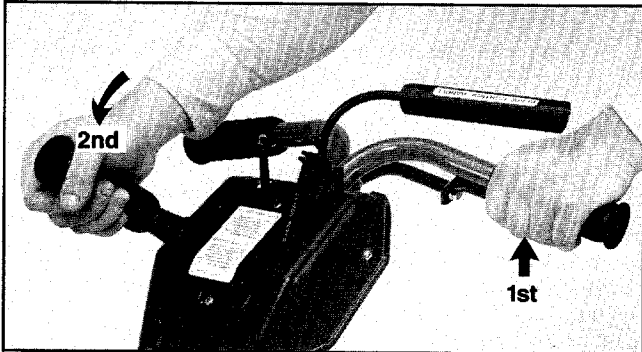

Photo 4-5: To engage the wheel drive on self-propelled models.

B. Increase or decrease the engine speed to adjust the ground speed.

C. TO STOP THE WHEELS, release the wheel drive handle from its position against the handlebar grip.

TO STOP THE ENGINE

A. Release the blade control handle and the wheel drive handle (on self-propelled models).

B. Put the engine throttle lever in the Slow (S) position.

C. Pull the engine throttle lever all the way back to the STOP position (and turn the key to OFF on electric start models).

CAUTION: To prevent injury from accidental or unauthorized starting, disconnect the spark plug wire and move the wire away from the plug when leaving the mower unattended or when the mower is not in use. Always remove the key from the switch on electric start models.

OPERATING THE MOWER

Use the following tips to help you in getting the best possible use from your TUFF-CUT® Mower.

A. Although your TUFF-CUT® Mower is wider and longer than ordinary mowers, its large rear wheels and perfect balance make it surprisingly easy to maneuver. Become familiar with your mower by first practicing with it in a clear, level section of your property, with the engine throttle control set at a slower engine speed setting. Practice engaging and disengaging the con-

trols until you are completely comfortable with their ease and manner of operation. Remember, with the self-propelled model, let the powered wheels do the work while you simply guide the mower along.

B. Making turns is exceptionally easy because the weight of the engine is centered over the rear wheels. Thus, you need only apply light downward pressure on the handlebars to tip up the front of the mower prior to making a turn. On self-propelled models, it's easier to make a turn if you first disengage the powered wheels by releasing the wheel drive handle. With the wheel drive disengaged, the inside wheel will pivot in place while the outside wheel rolls freely. After completing your turn, simply reengage power to the wheels and continue with your mowing.

WARNING: TO HELP AVOID PERSONAL INJURY:

- Exercise extreme caution when changing direction on slopes to prevent loss of control, slipping or falling.
- When mowing or turning on a slope with a self-propelled mower, keep the wheel drive lever ENGAGED until you are sure that you have complete control of the mower. Failure to do so could result in loss of control of the mower.
- Do not mow excessively steep slopes.

C. For precision trimming with the self-propelled mower, simply disengage the powered wheels by releasing the wheel drive handle. Then inch the mower forward by gradually pushing the "feather-touch" wheel drive lever forward until the drive cogs contact the wheels. To stop, pull back on the wheel drive lever.

D. When cutting tall growth, or if you are on uneven terrain, use the highest cut setting. Then gradually reduce to the desired cutting height over the course of 2 or 3 mowings. Go easy in extra tough grass or weeds as forcing the mower tends to make it slow down or stall.

E. Keep the blade sharp. A dull blade will tear, bruise and split the ends of grass.

F. Vary your cutting pattern from week to week. This helps to prevent matting and graining of the grass.

G. Always trim using the left side of the mower, as the discharge deflector is on the right side of the machine. Mow around obstacles in a counterclockwise direction (viewed from the operator's position). Also, mow with the discharge deflector pointed away from the obstacles on the first two passes. Then, reverse the direction. This will reduce the chances of damage to property from any thrown objects.

H. When mowing alongside a street or walk, mow with the discharge deflector pointed onto your own property (away from the street or walk). This will eliminate the need to sweep clippings from the sidewalks, etc.

I. Mow ditches in the direction of the ditch. This will result in debris and clippings being discharged into the ditch. Mow both sides of the ditch first, and then mow the bottom. When mowing ditches, watch out for cans, bottles, or other debris which could become dangerous high-speed projectiles.

J. While mowing, never point the discharge deflector at any person at any time.

SECTION 5

Maintenance and Adjustments

 **CAUTION:** To avoid personal injury, stop the engine, disconnect the spark plug wire, keep the wire away from the spark plug, and let the engine and muffler cool down before inspecting or servicing the mower or engine.

RECOMMENDED MAINTENANCE INTERVALS			
Maintenance Procedure:	Every Use	Every 10 Operating Hours	As Noted
Check blade for tightness	•		
Inspect nuts & bolts for tightness	•		
Inspect operator controls	•		
Clean underside of mower and inside of discharge chute	•		
Inspect blade for sharpness	•		
Inspect electric start wires and cables	•		
Inspect electrolyte level in battery		•	
Recharge battery			Before and after prolonged storage
Lubricate traction drive chain, linkages, pivot points, throttle control cable, and wheel mounting bolts and studs		•	
Check tension on wheel drive belt and chain		•	
Check tension on blade drive belt		•	
Check tire pressure		•	Or once a week, whichever is sooner.
Perform the Blade Brake Control 3-second Stop Test described on Page 34		•	At the start of each season and after every 10 operating hours.
Sharpen or replace blade			Whenever damaged, out of balance, or dull
ENGINE			
Inspect engine crankcase oil level	•		And after every 5 hours of continuous operation
Inspect throttle cable	•		
Clean air filter			At least every 25 operating hours — see engine owner's pamphlet.
Change engine crankcase oil			After 5 break-in operating hours and every 25 hours thereafter
Adjust carburetor			As required — see engine owner's pamphlet
Cooling system maintenance			See engine owner's pamphlet
Clean engine			See engine owner's pamphlet
Clean and reset spark plug			See engine owner's pamphlet

MOWER MAINTENANCE

ADJUSTING WHEEL DRIVE TRACTION (Self-Propelled Models Only)

On self-propelled mowers, there are two friction drive rollers located in front of the rear wheels. See Photo 5-1 or 5-2. These rollers propel the mower forward by pressing against the tires.

When the wheel drive lever is in the upright, NEUTRAL position, the rollers on 22" mowers should be approximately $3/16"$ away from the crown (highest point) of the tires. On 24" mowers, the clearance should be approximately $1/8"$. These two settings should provide adequate tire deflection ($3/8"$ and $7/16"$ respectively) for most mowing conditions. However, if extra traction is ever needed, the clearance between the rollers and the tires can be adjusted to a MINIMUM of $1/16"$, which will result in a tire deflection of $1/2"$.

NOTE: Use the minimum amount of tire deflection that will ensure adequate traction for the job at hand. Doing so will result in less wear on the tires and the rollers.

Follow the simple steps on this page to adjust the wheel drive rollers.

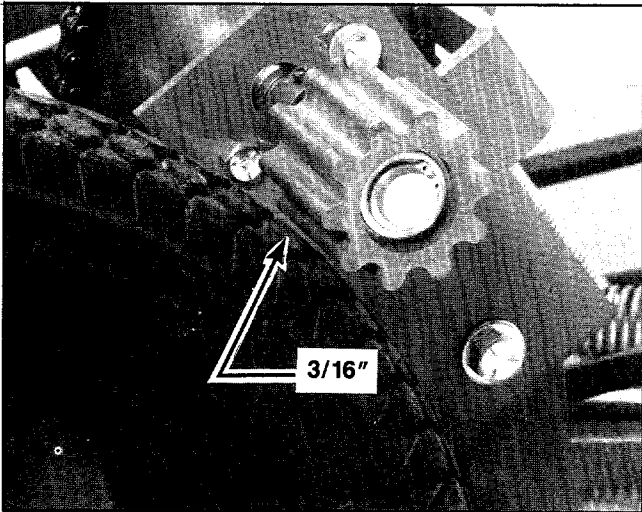

Photo 5-1: Clearance should be $3/16"$ for 22" mowers.

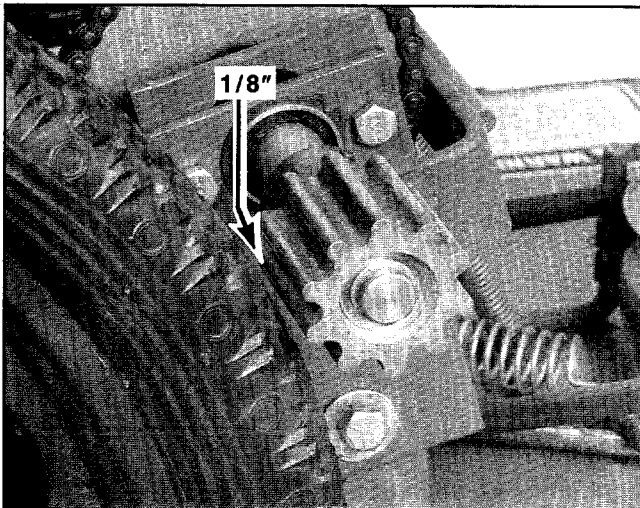

Photo 5-2: Clearance should be $1/8"$ for 24" mowers.

CAUTION: To avoid personal injury, stop the engine, disconnect the spark plug wire, keep the wire away from the spark plug, and allow the engine and muffler to cool before making repairs or adjustments.

A. Make certain that each tire is equally inflated to between 25-30 psi. Tire pressure is very important in maintaining correct friction roller tension.

B. Firmly grasp the threaded end of the lower drive control rod with one hand (to prevent it from springing forward when you release the clevis pin) and remove the spring clip and clevis pin that secures the traction adjustment block to the mounting bracket. See Photo 5-3.

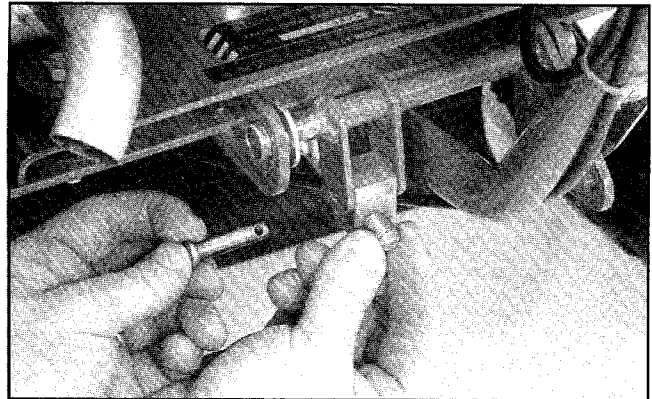

Photo 5-3: Hold control rod when removing clevis pin.

C. Rotate the adjustment block in a clockwise direction to reduce the clearance between the rollers and the wheels, or counterclockwise to increase the distance. See Photo 5-4. A few turns in either direction is usually all that will be needed for most adjustments.

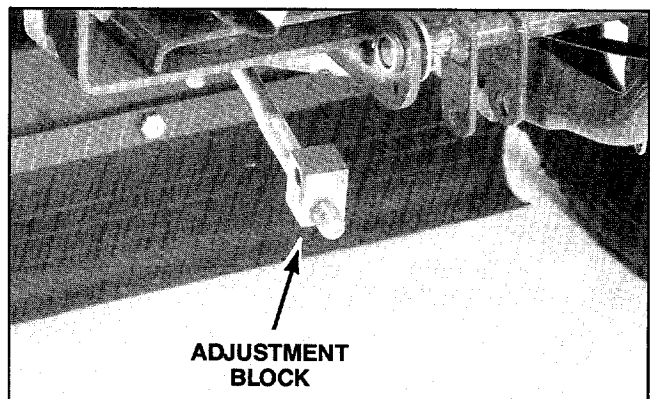

Photo 5-4: Thread adjustment block clockwise to reduce roller clearance, or counterclockwise to increase clearance.

D. Align the hole in the top of the adjustment block with the hole in the mounting bracket and replace the clevis pin and spring clip.

E. Engage and disengage the wheel drive lever several times to verify that the correct clearance is obtained. If not, repeat Steps B, C and D.

HEIGHT OF CUT ADJUSTMENT

The cutting height of your mower has been set at the factory to the third highest cutting position. This gives a cutting height of 2-7/8". The cutting height can be adjusted within a range of 1-5/8" to 3-1/2" (see table below). To change the cutting height, change the position of the rear and front wheels according to the following instructions.

REAR WHEEL POSITION SLOT	FRONT WHEEL POSITION HOLE	CUTTING HEIGHT
A	A	1-5/8"
B	B	2-1/4"
C	C	2-7/8"
D	D	3-1/2"

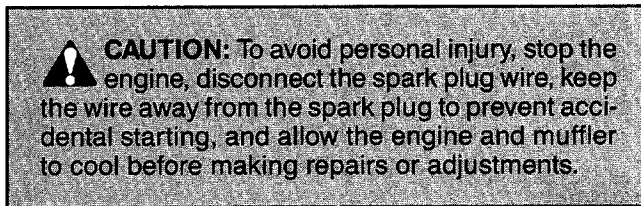

TOOLS NEEDED: 9/16" and 3/4" Wrenches.

- Prop up both sides of the mower below the blade housing, high enough to raise all four wheels off the ground.
- On self-propelled models only, disconnect the lower drive control rod by following Step B of the previous "Adjusting Wheel Drive Traction" instructions.
- Using a 9/16" wrench, loosen, but do not remove, the inside and outside flanged lock nuts that secure the rear wheels in place. See Figure 5-5. Remove the wheels and replace them in the same corresponding slots (A, B, C or D) on both sides.

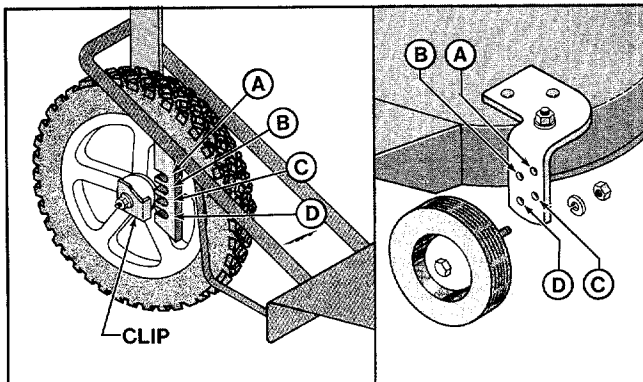

Figure 5-5: Wheel height adjustment positions.

- Position the inside and outside wheel retaining clips so that the bent legs are against the unslotted edge of the height adjustment brackets. Then tighten the inside and outside flanged lock nuts securely.
- Using 9/16" and 3/4" wrenches, remove the nut and lockwasher from each front wheel, leaving the mounting bolts in place. See Figure 5-5. Remove the wheels and replace them in the same corresponding

height adjustment holes (A, B, C or D) on both sides. Be sure that the front and rear wheels are located in the same relative settings (A, B, C or D).

- Replace the lockwashers and nuts on the front wheels, and tighten securely.
- Remove the props from beneath the blade housing.
- On self-propelled models only, you must readjust the wheel friction drive rollers to ensure that the clearance between the rollers and tires is correct (changing the wheel height alters the clearance). To do so, follow Steps C, D and E of the previous "Adjusting Wheel Drive Traction" instructions.

HANDLEBAR HEIGHT ADJUSTMENT

NOTE: The following step-by-step instructions apply only to self-propelled model mowers. If you have a push-propelled mower, refer to the height adjustment instructions found in "Step 2: Attach Handlebars", on Page 6.

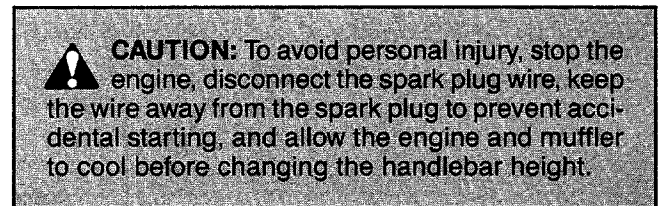

TOOLS NEEDED: Two 9/16" Wrenches.

- Install the Phillips screw into the alignment holes on the bellcrank and bellcrank mounting plate and attach the nut. This aligns the bellcrank. See Photo 5-6.

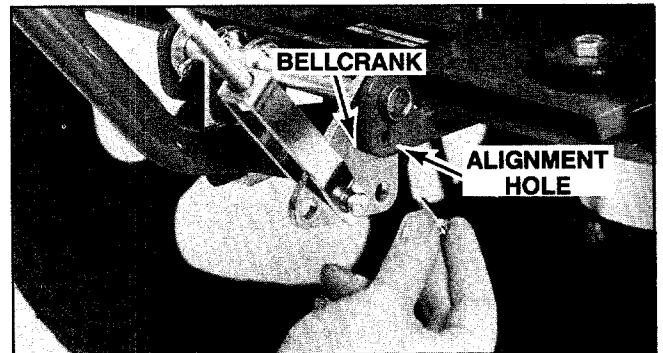

Photo 5-6: Align bellcrank with screw and nut.

- Disconnect the upper drive control rod by removing the spring clip and clevis pin that secures the control rod clevis to the bellcrank. See Photo 5-7.

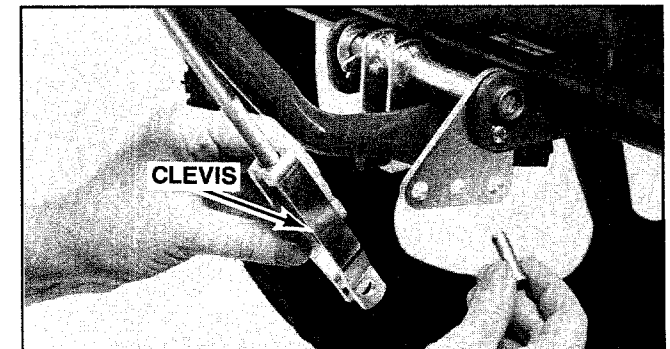

Photo 5-7: Disconnect clevis from bellcrank.

C. Adjust the handlebars to the desired height by following Steps D and E of the "Attach Handlebars" instructions on Page 6.

D. Whenever the handlebar height is changed, the position of the control rod clevis must be changed accordingly, relative to the height position of the handlebars. To change the clevis to the correct bellcrank hole, follow Steps B, C, E, F, G and H of the "Attach Wheel Drive Control Rod" instructions on Pages 6 and 7.

E. After securing the control rod clevis to the bellcrank with the clevis pin and spring clip, remove the screw and nut from the bellcrank alignment holes. Be sure to save the screw and nut for any future handlebar height adjustments.

F. With the wheel drive lever in the upright, NEUTRAL position, check that the clearance between the rollers and the tires is correct. See "Adjusting Wheel Drive Traction" on Page 22.

SHARPENING OR REPLACING THE MOWER BLADE

Check the condition of the mower blade before each use. If it is dull or slightly nicked, it should be sharpened as explained below. A deformed, cracked, or badly nicked blade should be replaced with a new one. While checking the blade, also check that the blade mounting screw is tightened securely.



CAUTION

- To avoid personal injury, stop the engine, disconnect the spark plug wire, keep the wire away from the spark plug, and allow the engine and muffler to cool before inspecting or servicing the blade.
- To avoid personal injury from contact with the sharpened blade, wear heavy gloves or wrap the blade with thick rags before working near it.
- To prevent a potential fire hazard from possible gasoline spills, make certain that the area is well ventilated and that you keep smoking materials, sparks or flame away.

TOOLS NEEDED: 9/16" Wrench, Flat Metal File.

A. Raise the front of the mower by anchoring the handlebars securely or by propping up the mower with sturdy blocks. On the 8 HP engine only, turn the fuel valve to the OFF position before tilting the mower back.

B. To remove the blade, hold the blade with one hand and remove the screw and conical (belleville) washer using a 9/16" wrench. See Photo 5-8.

C. If the blade needs sharpening, use a file to sharpen the cutting edge at both ends of the blade. Sharpen along the original cutting angle, filing in the direction of the cutting edge only. To maintain proper blade balance, be sure to remove the same amount of material from both cutting edges. Check the blade for balance by balancing it on the round shaft of a pen or pencil. If the blade cannot be balanced properly, it should be replaced with a new blade. An unbalanced blade can

cause excessive vibration which could result in engine damage, or personal injury if the blade should break.

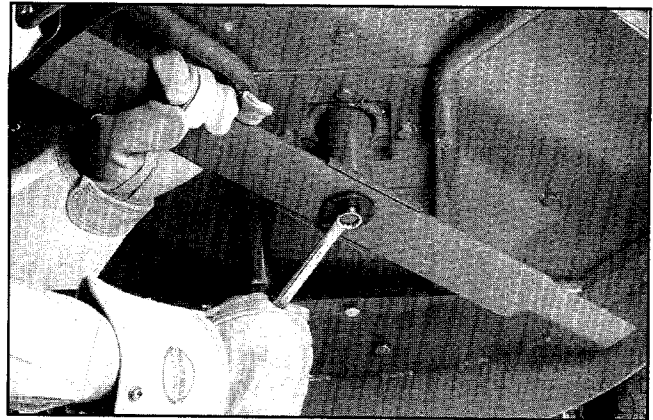

Photo 5-8: Remove screw and conical washer.

D. To reinstall the blade, first place the conical washer on the mounting screw, making certain that the concave side (hollowed side) of the washer is facing away from the head of the screw. See Figure 5-9.

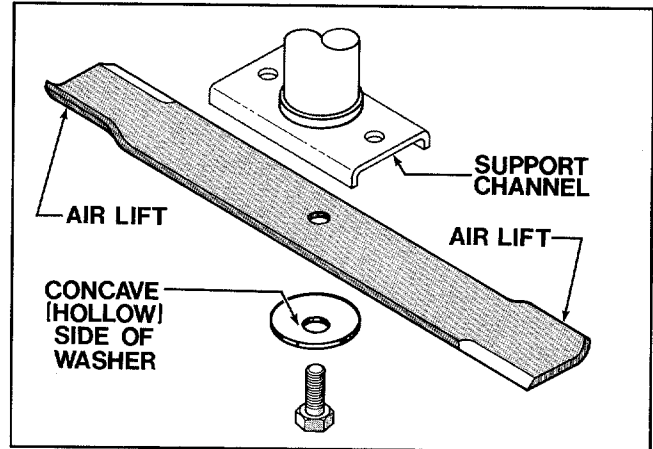

Figure 5-9: Install blade as shown.

IMPORTANT

Do not apply lubricant of any kind to the screw threads. The screw must be dry in order to work properly.

E. Place the blade in the support channel of the blade mounting bracket, making certain that the two air lifts at each end of the blade are pointing upward, toward the top of the mower deck.

F. Using your fingers only, tighten the screw finger-tight while gently rocking the blade up and down to properly seat the blade.

G. Tighten the screw to 38 to 42 ft. lbs. torque. If you do not have a torque wrench, use the following method to ensure that the screw is tightened correctly:

1. Using chalk, a grease marker, or paint, draw a thin line across one-half of the screw head as shown in Figure 5-10. Draw a similar reference line on the washer, directly opposite the line on the screw.

2. Be sure that the screw is tightened finger-tight as explained in Step F above. Then using the two lines as reference marks, tighten the screw 1¼ turns.

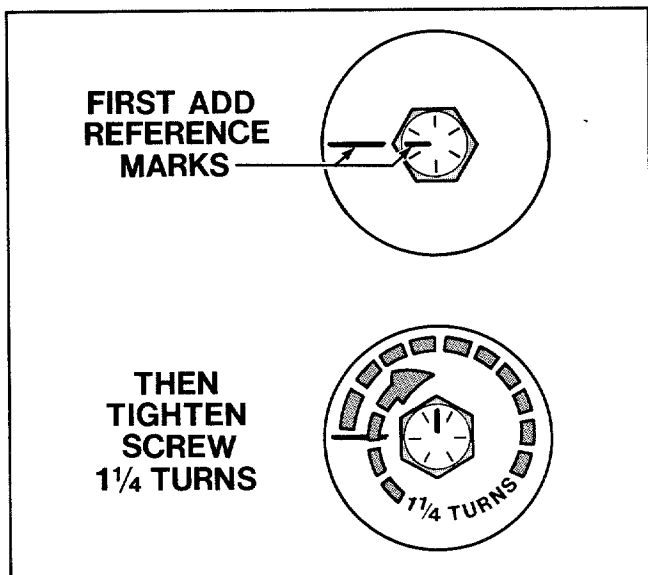

Figure 5-10: If you do not have a torque wrench, tighten mounting screw as shown above.

H. Remove any rags you may have used to cover the blade and then lower the front of the mower to the ground.

I. Reconnect the spark plug wire (and open the fuel valve on the 8 HP engine) before attempting to start the engine.

NOTE: Use only a "GRADE 8" screw to mount the blade. Refer to your Parts Catalog if a replacement screw is needed.

CLEAN THE MOWER HOUSING AND DISCHARGE CHUTE

Clean the underside of the mower housing and the discharge chute after every mowing. More frequent cleaning may be necessary under heavy cutting conditions.



CAUTION: To avoid personal injury, stop the engine, disconnect the spark plug wire, keep the wire away from the spark plug, and allow the engine and muffler to cool before cleaning the mower housing or discharge chute.

A. Raise the front of the mower about 6" by propping up the mower deck with sturdy blocks.

B. Spray the underside of the housing and the discharge chute with a garden hose to remove clippings and dirt (avoid spraying the engine or any electrical connections).

CHECK TIRE PRESSURE

Use a pocket-type tire pressure gage to check the inflation pressures in the rear tires. The tires should be equally inflated to between 25-30 psi. Check the inflation pressures after every 10 hours of operation or once a week, whichever occurs sooner.

CHECK BOLTS, SCREWS AND NUTS

Before each use, check all bolts, screws and nuts for tightness and keep them tightened securely at all times.

LUBRICATION

Clean and add several drops of light oil to the following points after every 10 operating hours:

1. All linkages and pivot points.
2. Drive chain on self-propelled models.
3. Both ends of the throttle control cable.
4. Wheel mounting bolts and studs.
5. The spring-loaded dowel pin found on the inside edge of the two friction drive rollers (see Ref. Nos. 100 and 98 in your Parts Catalog for the location of these two parts). After oiling, rotate the friction drive rollers to help spread the oil on the pins.

WHEEL DRIVE BELT TENSION (Self-Propelled Models Only)

Check the wheel drive belt tension after each 10 hours of operation. Due to normal stretch and wear on the belt, periodic adjustments may be required. While checking the tension, also look for obvious signs of wear such as cracks, cuts or fraying. If the belt is in poor condition, order a replacement from the Garden Way Parts Department. This is a special belt made for your mower and is not available locally.



CAUTION: Stop the engine, disconnect the spark plug wire, and allow the engine and muffler to cool before inspecting or servicing the drive belt.

TOOLS NEEDED: 7/16" and 1/2" Wrenches, Flat Blade Screwdriver, Rubber Mallet.

A. Remove the belt/pulley safety cover by removing the three hex nuts and two self-tapping screws.

B. To check for correct tension, use your thumb to press down in the center of the belt as shown in Photo 5-11. The tension is correct if the belt deflects between 1/2" to 5/8", under moderate thumb pressure (6-8 lbs. with 1/2" deflection).

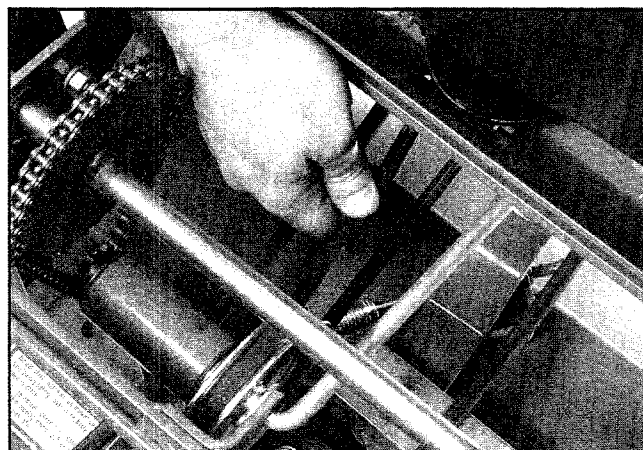

Photo 5-11: Check wheel drive belt tension.

C. Less than 1/2" deflection indicates that the belt is too tight; more than 5/8" deflection indicates that it is too loose. Use the following procedure if an adjustment is required.

D. Using a 1/2" wrench, slightly loosen (about 1/2 turn) the three hex nuts that secure the traction drive mounting bracket to the mower housing deck. See Photo 5-12.

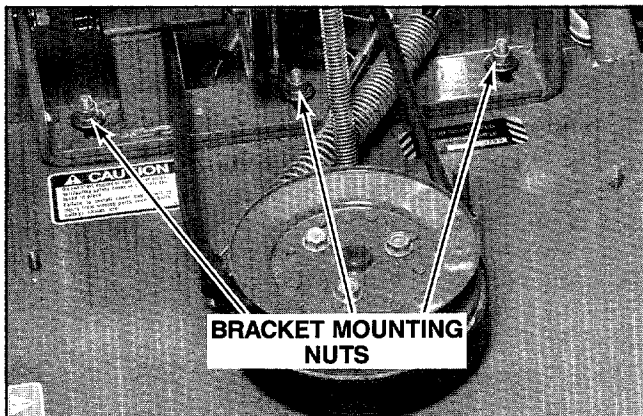

Photo 5-12: Slightly loosen three hex nuts.

E. To tighten the belt, use a mallet to drive both ends of the mounting bracket an equal distance toward the front of the mower. See Photo 5-13. When doing so, tap one end forward and retighten the nut on that end. Then, tap the other end forward and retighten the nut. To loosen the belt, move the bracket backward in a similar manner. Make certain that both drive rollers are equally spaced with the wheels.

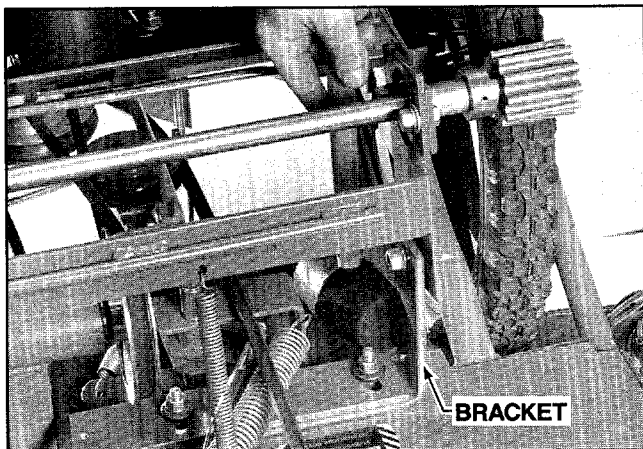

Photo 5-13: Tap ends of bracket forward to tighten belt or backward to loosen belt.

F. Check the tension on the belt as previously explained in Step B. Repeat Steps C, D and E as necessary.

G. Tighten all three mounting nuts securely. You may need to place a wrench on the screw heads to prevent the screws from turning while tightening the nuts. The screws are located at the rear of the blade housing. Wear heavy gloves or wrap the blade with rags before working near the blade.

H. Replace the belt/pulley safety cover, fastening it securely.

I. Check that the clearance between the wheel friction drive rollers and the tires is correct. See "Adjusting Wheel Drive Traction" on Page 22.

REPLACING THE WHEEL DRIVE BELT (Self-Propelled Models Only)

CAUTION: To avoid personal injury, stop the engine, disconnect the spark plug wire, keep the wire away from the spark plug, and allow the engine and muffler to cool before replacing the wheel drive belt.

TOOLS NEEDED: 7/16", 1/2" and two 9/16" Wrenches, Flat Blade Screwdriver, Rubber Mallet.

A. Remove the belt/pulley safety cover by removing the three hex nuts and two self-tapping screws.

B. Slightly loosen the three hex nuts on the traction drive mounting bracket, as explained in Step D of the previous "Wheel Drive Belt Tension" instructions.

C. Remove tension on the wheel drive belt and blade drive belt by using a mallet to drive the traction drive mounting bracket back toward the engine.

D. In the following steps, refer to Figure 5-14, which shows the wheel and blade drive belt/pulley systems.

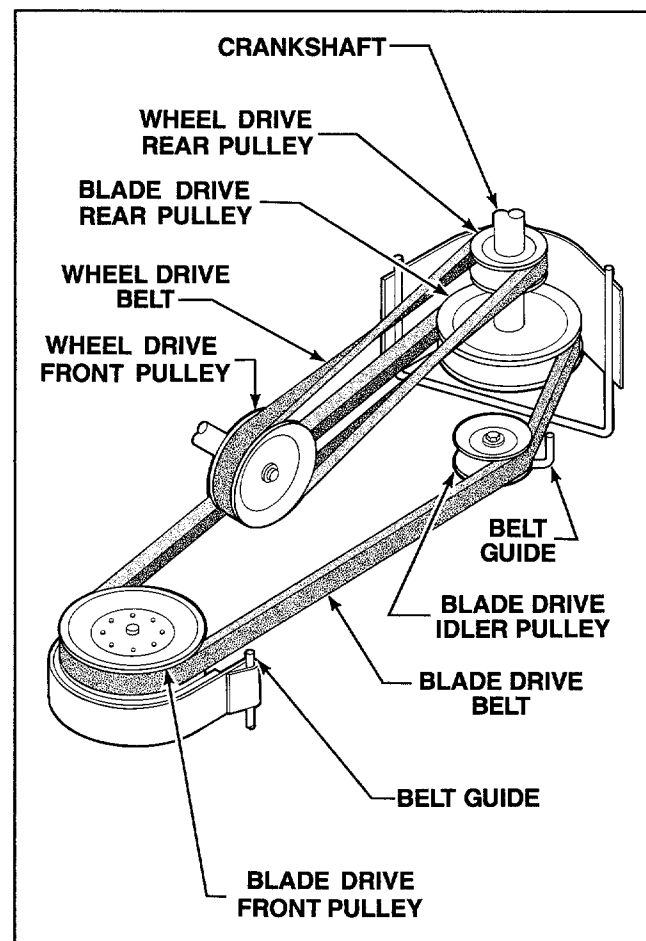

Figure 5-14: Wheel and blade drive belt/pulley systems.

E. To remove the wheel drive belt, it is first necessary to remove the blade drive belt from the blade drive rear pulley (lower pulley) located on the engine crankshaft. To do so, first loosen (do not remove) the screw and nut

on the blade drive idler pulley, using two 9/16" wrenches. Then slip the blade drive belt up and over the idler pulley belt guide. Finally, slip the blade drive belt down and off the blade drive rear pulley (lower pulley).

F. Slip the wheel drive belt down and off the wheel drive rear pulley (upper pulley). Temporarily leave the belt in between the upper and lower pulleys.

G. Remove the other end of the wheel drive belt from the wheel drive front pulley.

H. Return to the rear of the mower and slip the wheel drive belt down and off the blade drive rear pulley (lower pulley). The belt can now be removed through the opening between the lower pulley and the pulley belt guard.

I. Install the new wheel drive belt up through the opening between the rear belt guard and the blade drive rear pulley (lower pulley). Slip one end of the belt up and over the lower pulley, but do not seat it in the upper pulley at this time.

J. At the front of the mower, hold the wheel drive belt so it is flat, as shown in Photo 5-15. Then twist the belt 1/4 turn in a clockwise direction, as shown in Photo 5-16. Without changing the twist in the belt, seat the belt on the wheel drive front pulley.

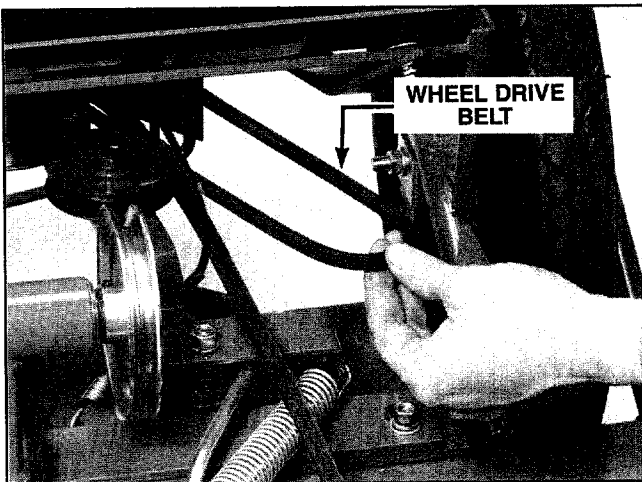

Photo 5-15: Hold wheel drive belt in flat position (traction drive mounting bracket removed for photo clarity only).

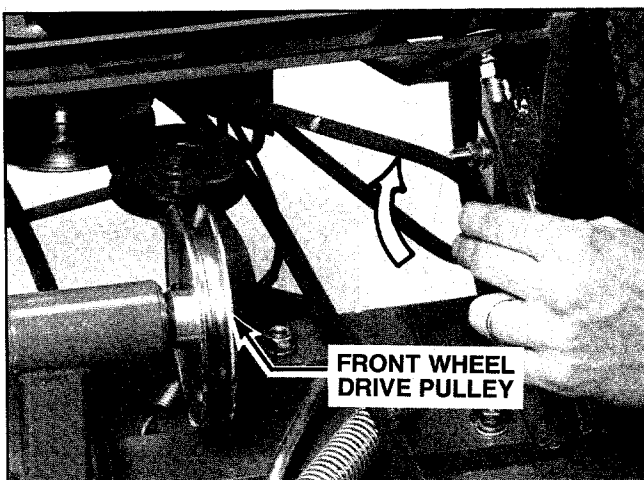

Photo 5-16: Twist belt 1/4 turn clockwise.

K. At the rear of the mower, seat the other end of the wheel drive belt on the wheel drive rear pulley (upper pulley).

L. Replace the blade drive belt on the blade drive rear pulley (lower pulley), making sure that the belt fits inside the belt guard that surrounds the rear and sides of the pulley.

M. Next replace the blade drive belt on the blade drive idler pulley, making sure that the belt fits inside the idler pulley belt guide. Securely tighten the screw and nut on the idler pulley.

N. Check that the blade drive belt is inside the belt guide located next to the blade drive front pulley.

O. Adjust the tension on the new wheel drive belt by following Steps E through I of the previous "Wheel Drive Belt Tension" instructions.

BLADE DRIVE BELT TENSION (All Models)

Check the blade drive belt tension after each 10 hours of operation. Due to normal stretch and wear on the belt, periodic adjustments may be required. While checking the tension, look for obvious signs of wear such as cracks, cuts or fraying. If the belt is in poor condition, order a replacement from the Garden Way Parts Department. This is a special belt made for your mower and is not available locally.



CAUTION: To avoid personal injury, stop the engine, disconnect the spark plug wire, keep the wire away from the spark plug, and allow the engine and muffler to cool before inspecting or adjusting the drive belt.

TOOLS NEEDED: 7/16" and two 1/2" Wrenches, Flat Blade Screwdriver, Ruler.

A. You will need a second person to assist you in performing Steps C and D.

B. Remove the belt/pulley safety cover by removing the three hex nuts and two self-tapping screws.

C. Tension on the blade drive belt is checked by measuring the length of the blade drive tension spring that is located on the end of the blade drive cable. See Photo 5-17. To measure the spring, have your assistant squeeze the blade control handle against the handlebar grip and then engage the blade control by pushing the control all the way forward until a distinct "click" is heard. While the blade control is in this engaged position, measure the length of the stretched spring.

D. The belt tension is correct if the stretched spring measures between 1 1/4" to 1 3/8". If the spring measures longer than 1 3/8" the belt needs to be loosened. If the spring measures shorter than 1 1/4" the belt needs to be tightened. Have your assistant release the blade control handle when you have finished measuring the spring.

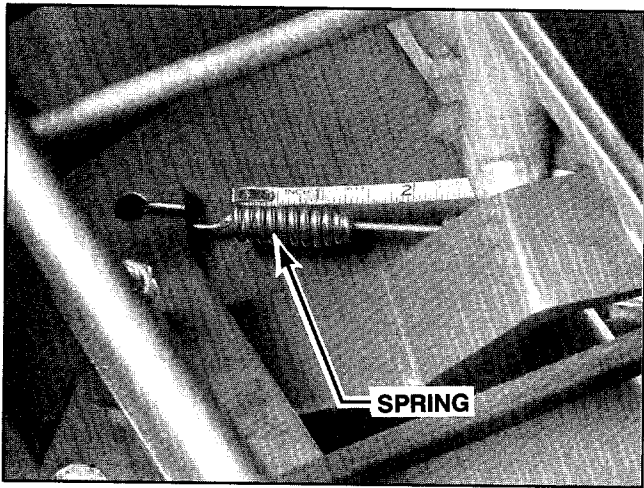

Photo 5-17: Measure length of blade drive tension spring while blade control is engaged.

E. Belt tension is adjusted by loosening the two jam nuts on either side of the blade drive cable mounting bracket and pulling the cable back toward the handlebars for increased tension, or pushing it forward for decreased tension. To avoid over-adjusting, it is recommended that the cable be moved only $\frac{1}{4}$ " per adjustment.

F. Using two $\frac{1}{2}$ " wrenches, loosen the front and rear jam nuts that are shown in Photo 5-18.

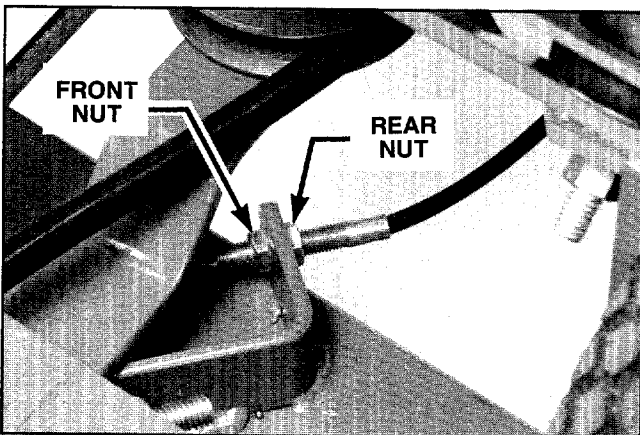

Photo 5-18: Location of jam nuts on blade drive control cable (traction drive mounting bracket removed for photo clarity only).

G. To increase belt tension, unthread the front jam nut and pull the cable back toward the handlebars. Thread the front jam nut against the cable bracket, then thread the rear jam nut against the bracket. Using two wrenches, hold the rear jam nut and tighten the front jam nut.

H. To decrease belt tension, unthread the rear jam nut and push the cable forward. Thread the rear jam nut against the cable bracket, then thread the front jam nut against the bracket. Using two wrenches, hold the front jam nut and tighten the rear jam nut.

I. Check for correct belt tension by measuring the length of the spring as previously explained in Steps C and D. Repeat Steps F, G and H as necessary.

J. Replace the belt/pulley safety cover, fastening it securely.

IMPORTANT

After adjusting blade drive belt tension, perform the Blade Brake Control Test Procedure described on Page 34 to ensure that the Blade Brake Control System is operating properly. See the WARNING below.

WARNING: If the blade does not stop within 3 seconds after releasing the blade control handle, move the throttle control to the STOP position. Immediately refer to the Blade Brake Control Test Procedure on Page 34. To avoid personal injury, do not operate the mower until the Blade Brake Control System is operating properly.

REPLACING THE BLADE DRIVE BELT (All Models)

CAUTION: To avoid personal injury, stop the engine, disconnect the spark plug wire, keep the wire away from the spark plug, and allow the engine and muffler to cool before replacing the blade drive belt.

TOOLS NEEDED: $\frac{7}{16}$ " and two $\frac{9}{16}$ " Wrenches, Pliers, Flat Blade Screwdriver.

A. Remove the belt/pulley safety cover by removing the three hex nuts and two self-tapping screws.

B. In the following steps, refer to Figure 5-19, which shows the blade drive belt and pulley system.

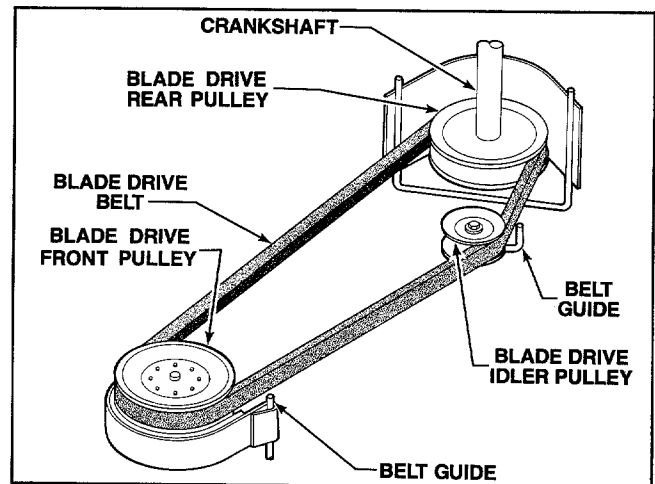

Figure 5-19: Blade drive belt/pulley system.

C. Using two $\frac{9}{16}$ " wrenches, loosen (but do not remove) the screw and nut on the blade drive idler pulley. Then slip the belt up and over the idler pulley belt guide.

D. Slip the belt down and off the blade drive rear pulley located on the engine crankshaft.

E. On self-propelled models only, unhook the upper end of the wheel drive return spring as shown in Photo 5-20.

F. Remove the belt from the blade drive front pulley and pull the belt out through the front of the mower.

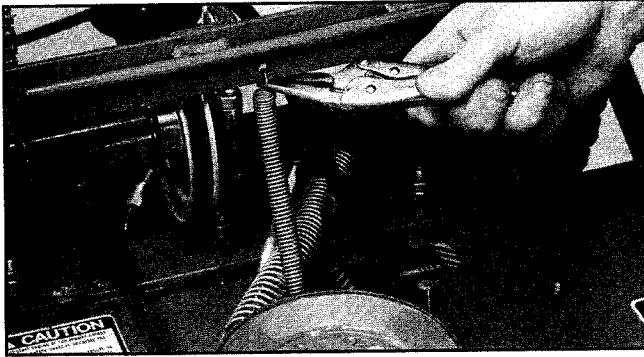

Photo 5-20: Unhook wheel drive return spring.

- G. Insert the new blade drive belt through the front of the mower and seat one end on the blade drive rear pulley. Make sure that the belt fits inside the belt guard that surrounds the rear and sides of the pulley.
- H. Install the other end of the belt on the blade drive front pulley, making sure that the belt fits inside the belt guide next to the pulley.
- I. Seat the belt on the blade drive idler pulley, making sure that the belt fits inside the idler pulley belt guide. Securely tighten the screw and nut on the idler pulley.
- J. On self-propelled models only, reinstall the spring in the main wheel engagement bracket, making sure that the hook is engaged fully.
- K. Adjust the tension on the belt by following Steps C through J of the previous "Blade Drive Belt Tension" instructions.

IMPORTANT

After replacing blade drive belt, perform the Blade Brake Control Test Procedure described on Page 34 to ensure that the Blade Brake Control System is operating properly.

WHEEL DRIVE CHAIN TENSION (Self-Propelled Models Only)

Periodically check the tension on the wheel drive chain. Due to normal stretch and wear on the chain, it may need occasional tightening.

CAUTION: To avoid personal injury, stop the engine, disconnect the spark plug wire, keep the wire away from the spark plug, and allow the engine and muffler to cool before inspecting or servicing the drive chain.

TOOLS NEEDED: Two 7/16" Wrenches, Flat Blade Screwdriver.

- A. Remove the belt/pulley safety cover by removing the three hex nuts and two self-tapping screws.
- B. To check for correct tension, use your thumb to press in on the center of the chain. See Photo 5-21. The chain tension is correct if the chain deflects approximately 1/8" to 1/4".
- C. To adjust the tension, slightly loosen the two chain drive adjustment screws on the right side of the friction drive axle assembly. See Photo 5-22. Push the axle assembly up to tighten the chain, or down to loosen the chain, and retighten the two screws.

D. Loosen the two adjustment screws on the left side of the axle assembly and adjust that end of the axle assembly an equal distance up or down (the two front screws must be in the same relative positions in their adjustment slots). Tighten the two left side screws securely.

E. Check the tension on the chain as previously explained in Step B. Repeat Steps C and D as necessary.

F. Replace the belt/pulley safety cover, fastening it securely.

G. Check that the clearance between the wheel drive rollers and the tires is correct. See "Adjusting Wheel Drive Traction" on Page 22.

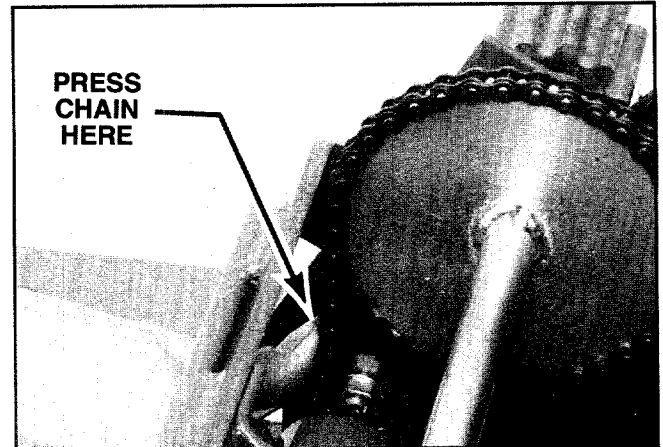

Photo 5-21: Check wheel drive chain tension.

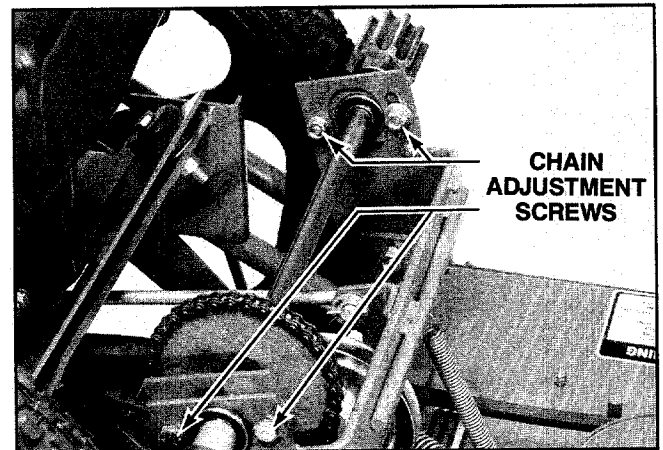

Photo 5-22: Loosen screws to adjust chain tension.

REPLACING THE BLADE BRAKE BAND

CAUTION: To avoid personal injury, stop the engine, disconnect the spark plug wire, keep the wire away from the spark plug, and allow the engine and muffler to cool before removing or replacing the blade brake band.

TOOLS NEEDED: Pliers

- A. Remove the belt/pulley safety cover by removing the three hex nuts and two self-tapping screws.
- B. Unhook the blade brake spring from the blade drive engagement bracket. See Photo 5-23.

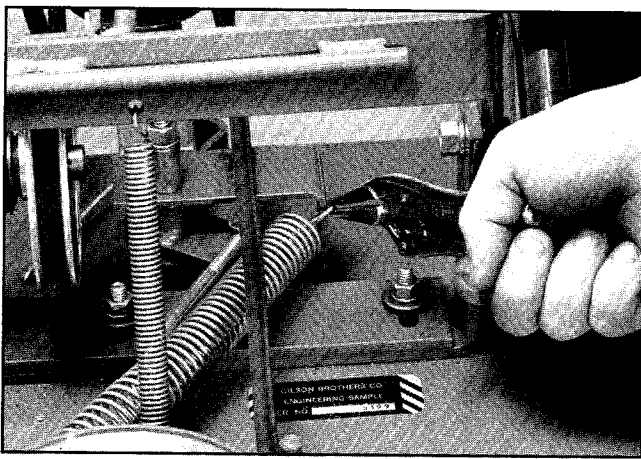

Photo 5-23: Unhook spring from blade drive bracket.

C. Unhook the other end of the spring from the brake control rod. See Photo 5-24.

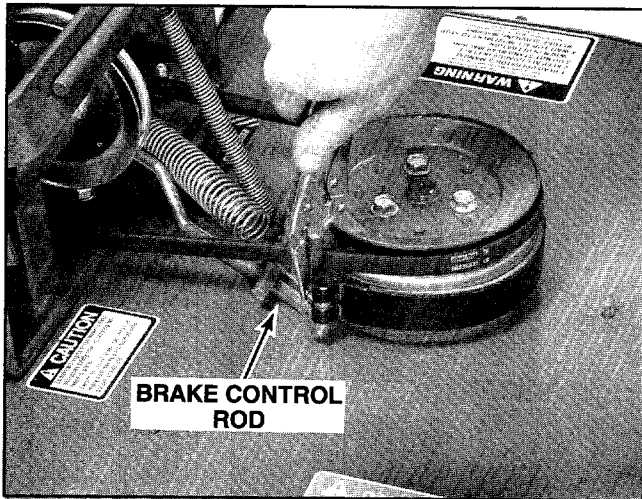

Photo 5-24: Unhook spring from brake control rod.

D. Remove the cotter pin from the belt guide located next to the blade drive front pulley. See Photo 5-25.

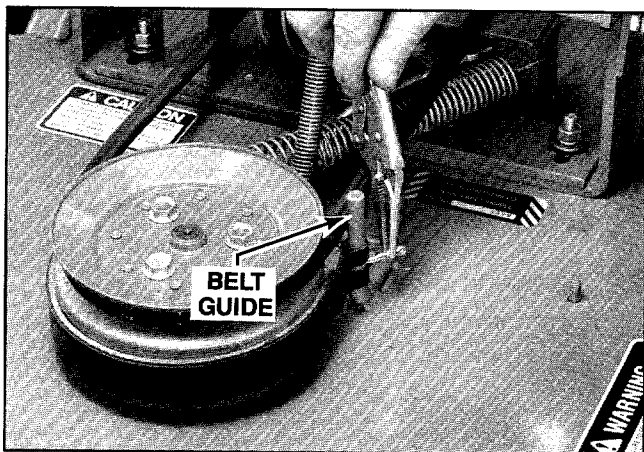

Photo 5-25: Remove cotter pin.

E. Remove the old brake band. See Photo 5-26.

F. Install the new brake band on the brake control rod and belt guide. Be sure to align the slots in the two ends of the band with the holes in the control rod and belt guide.

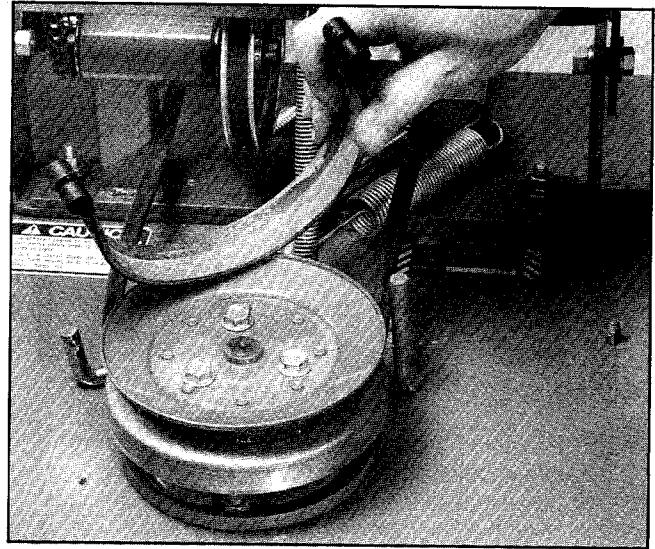

Photo 5-26: Remove brake band.

G. Replace the cotter pin in the belt guide hole. Bend the ends of the cotter pin over to hold it securely in place.

H. Hook the long end of the spring hook into the hole in the brake control rod. See Photo 5-24.

I. Hook the other (short) end of the spring hook into the hole in the blade drive engagement bracket. See Photo 5-23.

J. Replace the belt/pulley safety cover, fastening it securely.

IMPORTANT

After replacing the brake band, perform the Blade Brake Control Test Procedure described on Page 34 to ensure that the Blade Brake Control System is operating properly. See the WARNING below.

WARNING: If the Blade Brake System is damaged or maladjusted, the blade may continue to rotate after you have released the blade control handle. If the blade does not stop within 3 seconds of release of the blade control handle, move the engine throttle control to the STOP position. Immediately refer to the Blade Brake Control Test Procedure on Page 34. To avoid personal injury, do not operate the mower until the Blade Brake Control System is operating properly.

BATTERY CARE AND MAINTENANCE

WARNING: Follow the battery Safety Rules on Pages 10-14 of this manual when working on or near the battery. Failure to carefully follow all Safety Rules may result in personal injury or property damage from such causes as an explosion of battery gases, acid burns or electrical burns.

The following guidelines will help to protect your battery while it is in service during seasonal use and during extended periods of storage. To ensure maximum battery life and performance, these guidelines should be followed carefully.

CARE IN SERVICE

A. Once a month or every 10 operating hours, whichever occurs first, check the level of the electrolyte. Make certain that the electrolyte is filled to the UPPER LEVEL LINE as marked on the battery case. If necessary, add distilled or demineralized water to restore the electrolyte to the correct level. NEVER USE BATTERY ACID TO REFILL THE BATTERY. Replace the battery caps securely and wipe top of battery after filling. Then run the engine outdoors for about 20 minutes at 3/4 throttle speed to help recharge and recirculate the electrolyte solution. For safety, do not leave the mower unattended while the engine is running.

 **DANGER:** Electrolyte is SULFURIC ACID solution. Avoid spillage and contact with skin, eyes and clothing. Wear protective clothing, rubber gloves, and shield eyes with safety goggles. See POISON/DANGER Safety Rule on Page 10 of this manual.

B. The battery should be kept clean at all times. If corrosion is found on the battery posts or cable terminals, the battery should be removed (see instructions that follow) and cleaned with a baking soda and water solution. Be sure to tighten the battery caps securely before cleaning and to rinse the battery and wipe it dry when finished. AVOID GETTING THE CORROSIVE MATERIAL (WHICH IS ACID OXIDATION) ON YOUR SKIN OR IN YOUR EYES. Use a wire brush, sandpaper or steel wool to clean the posts and terminals. Then coat the posts and terminals with petroleum jelly or silicone grease to prevent new corrosion from forming.

C. Periodically check the entire electrical system for loose or dirty connections.

D. Periodically check that the battery clamp is tight enough to keep the battery firmly in place. Do not over-tighten the clamp as it could damage the battery case.

E. Periodically check that the vent tube is not crimped or pinched anywhere along its length.

BATTERY STORAGE

The engine on your mower is equipped with a recharging circuit that will properly maintain the battery's state of charge during the regular mowing season. When the mower will not be used for an extended period of time, we recommend that the battery be fully charged before placing it in storage. Before reinstalling the battery after storage, it should again be given a thorough recharge. Proceed as follows:

 **DANGER**

- Batteries generate explosive gases. Keep sparks and flames away from battery at all times.
- Ventilate area when charging or using battery in an enclosed space.
- While the battery is being charged, do not leave it unattended. The charging time does not have to be continuous.
- Carefully follow all charging instructions and Safety Rules provided by the manufacturer of the charging equipment.

A. Remove the battery from the mower (see instructions that follow) and place it on a level surface.

B. Clean the battery if needed. If the battery is extremely cold, allow it to warm to between 60°F to 80°F.

C. Remove all filler caps. Leave caps off during the filling and charging instructions.

D. Carefully check the electrolyte level. If, and only if, the electrolyte level is below the middle of the UPPER and LOWER LEVEL lines, add distilled or demineralized water (DO NOT ADD ACID) until the level reaches the UPPER LEVEL line. Avoid overfilling.

E. Charge the battery completely until all of the cells are gassing freely. Refer to Step F on Page 11 of this manual for the proper charging time and amperage rating.

F. When the battery is fully charged, turn off the charger and then disconnect the cables. Add water (NOT ACID) to adjust the electrolyte level to the correct height. Then reconnect the charger cables to the battery and charge the battery until the cells are fully gassing once again.

G. Replace the filler caps and wash off any spilled electrolyte with a baking soda and water solution.

H. Store the battery in a cool, dry place away from heat ducts, radiators and direct sunlight. Avoid freezing temperatures. A battery loses voltage in storage, more so in hot weather than in cold. An ideal storage temperature is 50°F.

BATTERY REMOVAL AND REPLACEMENT

 **WARNING:** When removing the battery, be sure to disconnect the negative cable first, followed by the positive cable. Reverse this procedure when replacing the battery.

A. Turn the ignition key to the OFF position and remove the key. Then disconnect the spark plug wire from the spark plug. Move the spark plug wire away from the spark plug to prevent accidental starting.

B. Disconnect the negative (-) cable from the grounding screw located on the left side, rear of the engine. Bend the cable safely away from any metal parts.

C. Disconnect the negative (-) cable from the negative battery post and remove the cable.

D. Disconnect the positive (+) cable from the positive battery post (leave the other end connected to the solenoid). Cover the loose end of the cable with the rubber boot.

E. Remove the battery hold-down clamp and remove the battery.

F. Reverse the above steps when replacing the battery.

STARTING THE ELECTRIC START ENGINE WITH THE RECOIL STARTER ROPE

If necessary, the electric start engine can be started with the recoil starter rope. However, before doing so be sure to follow the procedure below that applies to your particular situation.

A. If the battery is in good condition (not "dead" or damaged), you can leave it on the mower which allows it to be recharged during engine operation. But, before starting the engine with the recoil rope, make sure that the battery is filled to the UPPER LEVEL with electrolyte and that all of the cables and wires are properly connected.

B. If the battery is "dead" or damaged, then it should be removed from the mower and tested by a qualified battery mechanic. While the battery is removed, keep the loose terminal on the positive battery cable covered with a wrapping of electrical tape and secure the cable to the frame of the mower. Taping over the terminal will prevent any possibility of sparking from the cable terminal.

IMPORTANT

When starting the engine with the recoil starter rope, the key switch must first be placed in the RUN position and the engine throttle lever in the CHOKE position.

ENGINE MAINTENANCE

IMPORTANT

Perform only the routine engine maintenance described here and in the engine owner's pamphlet. For other maintenance and parts, contact an authorized Briggs & Stratton Service Dealer. Any unauthorized work done on the engine during the warranty period may void your warranty. For full details on the engine manufacturer's limited warranty, please see the separate engine owner's pamphlet. (If you have any difficulty in finding an authorized dealer or in obtaining warranty service, please contact the Garden Way Technical Service Department for assistance.)



CAUTION: To avoid personal injury, stop the engine, disconnect the spark plug wire, keep the wire away from the spark plug, and allow the engine and muffler to cool before inspecting or servicing the engine.

ENGINE CRANKCASE OIL

It is vitally important that you use motor oil of the proper service grade and viscosity, and that you regularly check and change the oil according to the recommended hours of operation. Incorrect, insufficient, or dirty oil will cause premature engine wear and damage.

A. Check the oil level before each use and after each 5 hours of continuous operation. Do not run the engine unless the proper oil level is maintained. See Section 2 for detailed instructions.

B. Change the oil after the first 5 hours of operation and every 25 hours thereafter. Change the oil more frequently in extremely dusty or dirty conditions. Refer to your engine owner's pamphlet for oil changing instructions.

IMPORTANT

Your engine has been equipped with an extended oil drain pipe. See Photo 5-27 or 5-28.

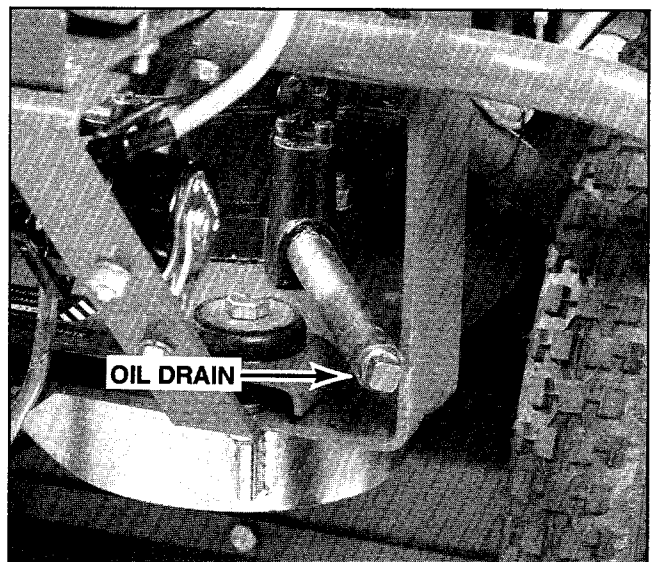

Photo 5-27: Oil drain on 5 HP engine.

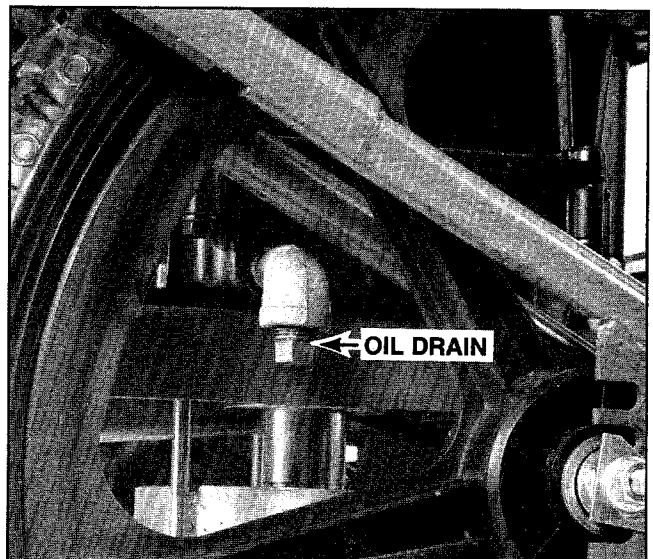

Photo 5-28: Oil drain on 8 HP engine.

ENGINE AIR CLEANER

The air cleaner must be kept clean and properly installed at all times. A dirty, clogged filter can cause hard-starting, stalling, or over-heating problems. An improperly installed or damaged filter can allow unfiltered air into the engine, resulting in premature engine wear and damage. Never operate the engine without the air cleaner installed.

A. Clean the air cleaner after every 25 operating hours, or sooner under extremely dusty or dirty operating conditions. To service the air cleaner, refer to the "Oil Foam" air cleaner instructions in your engine owner's pamphlet.

CARBURETOR ADJUSTMENTS

The carburetor provides the engine combustion chamber with the correct air-fuel ratio for a wide range of operating conditions. Factory settings should be correct for average operating conditions — do not make unnecessary adjustments. If you feel an adjustment is needed (to compensate for differences in fuel, temperature, altitude or load), refer to the instructions in your engine owner's pamphlet.

AIR COOLING SERVICE

Periodically check and clean dirt and grass from the cylinder head fins, blower housing, rotating screen, and muffler area. This will result in better engine performance. See your engine owner's pamphlet for detailed instructions.

SPARK PLUG

The spark plug provides the necessary spark to ignite the fuel mixture in the engine combustion chamber. It is essential to proper engine operation to have a plug that is properly adjusted and in good condition. Clean and reset, or replace the plug after every 100 hours of operation. See your engine owner's pamphlet for servicing instructions.

THROTTLE CABLE ADJUSTMENTS

An adjustment to the throttle cable may be required if the engine does not start or stop, or if it does not respond to various throttle control settings. Refer to your engine owner's pamphlet for servicing instructions.

ENGINE SPEEDS

The recommended engine speed settings for the 5HP and 8HP engines are listed below. These settings will provide optimum engine and mower performance and will maintain compliance with the American National Standards Institute safety standards. If an adjustment is required, it should be done by an engine dealer who is authorized by the engine manufacturer to perform this procedure.

	Normal RPM	Maximum RPM
5HP Engine:	3400	3500
8HP Engine:	3500	3600

OFF-SEASON STORAGE

- A. Run the engine until all the gasoline is used up. Do not store your mower with gasoline in the fuel tank because gum deposits could form on carburetor parts and in the fuel lines and tank. After draining the gasoline on 24" models, turn the fuel valve to the OFF position.
- B. As an alternative to removing all of the gasoline from the fuel tank, the use of a fuel additive such as STA-BIL® or the equivalent will minimize the formation of gum deposits. Carefully follow the directions provided by the manufacturer of the fuel additive.
- C. While the engine is still warm, drain the engine crankcase oil according to the procedure in your engine owner's pamphlet. Refill with fresh oil.
- D. Remove the spark plug and pour one ounce of engine oil into the cylinder. Crank the cylinder slowly to distribute the oil. Replace the spark plug.
- E. Clean dirt and grass from the cylinder head, fins, blower housing, rotating screen and muffler areas.
- F. Clean the underside of the mower.
- G. Check the condition of the blade and check the blade for tightness along with the remaining nuts and bolts on the mower.
- H. Perform the routine lubrication and air cleaner maintenance.
- I. Charge the battery on electric start models and store the battery in a cool, dry place.
- J. Cover the mower and store it in a clean, dry place.
- K. Never store the mower with gasoline in the tank inside a building where fumes may reach an open flame or spark.
- L. Remember — this is a good time to order replacement parts for the next mowing season.

ENGINE NUMBERS

When seeking engine service or parts, you may be asked for the Model Number, Type Number, and Code Number of your engine. These numbers can be found on the engine as shown in Photos 5-29 and 5-30.

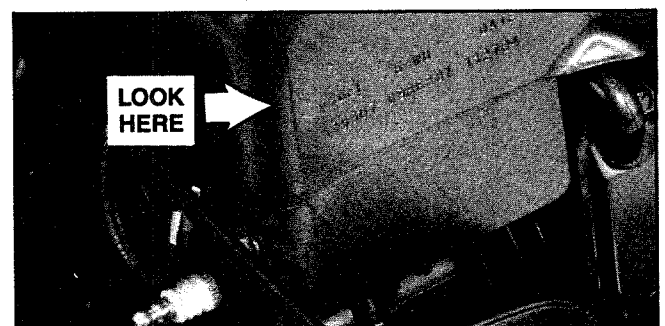

Photo 5-29: Identification numbers on 5 HP engine.

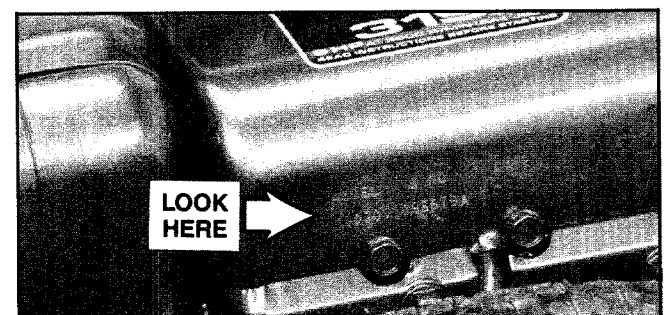

Photo 5-30: Identification numbers on 8 HP engine.

BLADE BRAKE CONTROL TEST PROCEDURE:

The Blade Brake Control mechanism stops the mower blade within 3 seconds of release of the Blade Control Handle. The Blade Brake Control on your TUFF-CUT® Mower is designed to operate properly for the life of the mower. However, because the control is a mechanical device which is subject to wear and exposure to the elements, the following test procedure should be performed to ensure that the Blade Brake Control is functioning properly. The test should be performed according to the following schedule:

- At the start of each season.
- At minimum, after every 10 hours of operation.
- After every blade belt adjustment or replacement.
- After every replacement of the blade brake band.

CAUTION: To avoid personal injury or property damage, make sure that the mower is on grass, and the test area is clear of foreign objects and bystanders, before you begin the Blade Brake Test.

Because the engine is running during the test, the procedure must be performed outdoors.

WARNING: To avoid personal injury, never run the engine in an enclosed or poorly ventilated area. Engine exhaust contains carbon monoxide, an odorless and deadly gas.

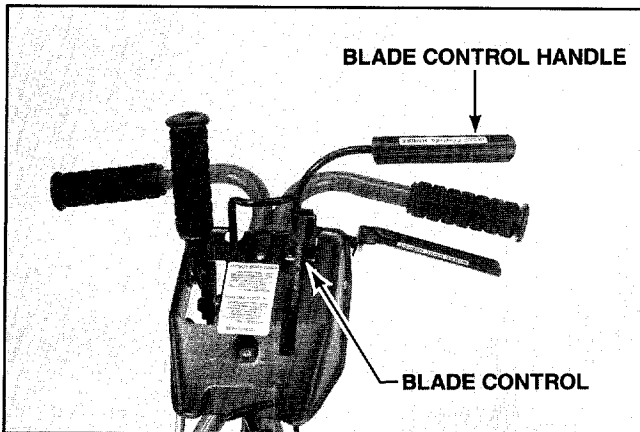

Photo 5-31: Controls used in Blade Brake Control Test.

TEST:

Step 1: Start the engine as described on Page 19.

Step 2: Engage the blade drive by squeezing the Blade Control Handle against the handlebar grip and pushing the Blade Control forward until a distinct "click" is heard. Listen for the sound of air movement produced by the blade. Air movement noise indicates that the blade is engaged and is rotating.

Step 3: Release the Blade Control Handle. Note a soft "bang" (caused by the brake band wrapping tightly against the blade pulley and drum).

Step 4: The blade should stop within 3 seconds. You will know that the blade has stopped because air movement noise will cease. If not, stop the engine and disconnect the spark plug wire. Move the wire away from the spark plug to prevent accidental starting. Do not operate the mower until it has been inspected, adjusted or repaired. See the Troubleshooting Section, Page 36 for possible solutions if the Blade Brake Control System is not operating properly.

Step 5: If the blade stops within 3 seconds, no immediate service for the Blade Brake Control System is needed.

SECTION 6

Troubleshooting

The following are easy owner checks. If your mower still does not operate properly after you investigate the possible causes described below, call or write the Garden Way Technical Service Department. Our mower experts can help you with more complicated troubleshooting of your machine.

 **CAUTION:** To avoid personal injury, stop the engine, disconnect the spark plug wire, keep the wire away from the spark plug, and allow the engine and muffler to cool before inspecting or servicing the engine or mower.

PROBLEMS	POSSIBLE CAUSE	CORRECTIONS
<p>Engine Does Not Start (All Engines):</p> <p>(Electric Start Engines):</p>	<ol style="list-style-type: none"> Spark plug wire is not attached. Fuel tank is empty Throttle lever not in CHOKE position. Spark plug fouled or gap incorrect. Battery weak due to low electrolyte level. Loose or dirty electrical connections. 	<ol style="list-style-type: none"> Attach spark plug wire. Fill fuel tank with gasoline. Move throttle lever to CHOKE. Clean, adjust or replace plug. See engine owner's pamphlet. If electrolyte level is low, add distilled water and recharge battery by starting engine with recoil starter. See Section 5 for starting procedure. Check and tighten connections.
<p>Engine Starts Hard or Loses Power</p>	<ol style="list-style-type: none"> Dirt, water, or stale fuel in the fuel tank. Air cleaner is dirty. Spark plug fouled or gap incorrect. 	<ol style="list-style-type: none"> Drain gas, clean fuel tank and refill with fuel. Clean air cleaner — see engine owner's pamphlet. Clean, adjust or replace plug. See engine owner's pamphlet.
<p>Engine Idles Poorly</p>	<ol style="list-style-type: none"> Air cleaner is dirty. Air slots in shroud are clogged. Cooling fins and air passages under engine housing are plugged. 	<ol style="list-style-type: none"> Clean air cleaner — see engine owner's pamphlet. Remove any obstructions. Remove any obstructions.
<p>Engine Overheats</p>	<ol style="list-style-type: none"> Cooling air flow restricted. Oil level in crankcase is low. 	<ol style="list-style-type: none"> Remove any obstructions from slots in shroud, blower housing, air passages, and cooling fins. Add oil to engine crankcase.
<p>Mower Vibrates Abnormally</p>	<ol style="list-style-type: none"> Blade bolt is loose. Blade is unbalanced. Blade spindle is bent. Loose nuts and bolts, especially engine mounting bolts. 	<ol style="list-style-type: none"> Tighten blade bolt securely. Sharpen blade and check balance. Replace blade if it cannot be properly balanced. Replace spindle (contact Garden Way Technical Service Department.) Check and tighten nuts and bolts.

Uneven or Poor Cut	<ol style="list-style-type: none"> 1. Dull or damaged blade. 2. Wheel heights not uniform. 	<ol style="list-style-type: none"> 1. Sharpen or replace blade. 2. Check wheel height positioning slots and holes.
Poor Discharge of Grass Clippings	<ol style="list-style-type: none"> 1. Mower housing or discharge chute clogged. 2. Dull or damaged blade. 	<ol style="list-style-type: none"> 1. Clean accumulations of grass and debris 2. Check condition of blade.
Blade Does Not Stop Within 3 Seconds of Release of Blade Control Handle	<ol style="list-style-type: none"> 1. Brake band loose. 2. Brake band worn. 3. Blade brake control not operating properly. 	<ol style="list-style-type: none"> 1. To tighten the band, shorten the brake control rod. Follow the steps given on Pages 29 and 30 for replacing the band, through Step D. Then follow the procedure given below.* 2. Replace the band and refer to the Blade Brake Test Procedure on Page 34. 3. Refer to the Blade Brake Test Procedure on Page 34. Call the Garden Way Technical Service Department for additional instructions.
No Traction (Self-Propelled Models)	<ol style="list-style-type: none"> 1. Tire inflation is incorrect. 2. Wheel friction drive rollers not properly adjusted. 3. Incorrect drive belt tension. 	<ol style="list-style-type: none"> 1. Inflate tires to 25-30 psi. 2. Perform adjustment procedure described in Section 5. 3. Check and adjust belt — see procedure in Section 5.
Mower Creeps Forward (Self-Propelled Models)	<ol style="list-style-type: none"> 1. Wheel friction drive rollers not properly adjusted. 	<ol style="list-style-type: none"> 1. Perform adjustment procedure described in Section 5.

*After following the procedure on Pages 29 and 30 through Step D, to shorten the brake control rod:

- a) Lift the band off until the rod is free (rod is shown in Photo 5-24).
- b) Turn the rod clockwise a turn or two.
- c) Reinstall the band by following Steps F through I on Page 30.
- d) Make sure that the engine is stopped, and the spark plug wire is disconnected and away from the spark plug to prevent accidental starting, before going on to Step e below.
- e) To test that the band is tight, have someone engage the blade brake (see Photo 3-2 on Page 15) while you try to turn the spindle pulley by hand in the normal rotating direction.
- f) If the band is tight, the pulley spindle should not rotate.
- g) If the spindle pulley is loose, this indicates that the old band is worn beyond adjustment and should be replaced. See the procedure on Page 29.
- h) Note that if a new band is to be installed after the rod length has been shortened, it will be necessary to lengthen the rod by turning it counterclockwise several turns until the end of the band fits on the rod.
- i) After replacing the belt/pulley safety cover perform the Blade Brake Control Test Procedure on Page 34.

SWIVEL WHEEL KIT

A swivel wheel kit is available as an option on all TUFF-CUT Mowers. Swivel wheels are recommended for use where increased maneuverability is needed, such as mowing property that contains numerous trees or other objects. The wheels can also be locked in a straight-ahead tracking position for use when mowing rough or sloping ground.

The swivel wheels are easy to assemble and can be adjusted to the four cut of height settings described in Section 5 of this manual. The kit does not contain the wheels or the wheel mounting hardware, you use your existing front wheels and hardware to complete the assembly.

Please call or write our Parts Department for ordering and pricing information.

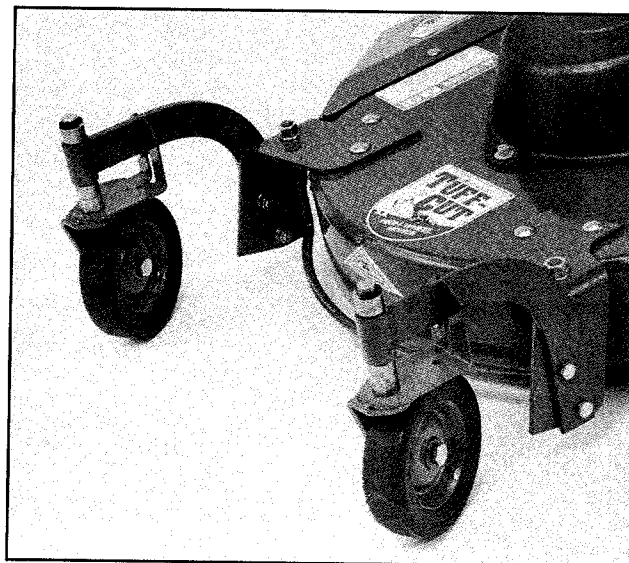

The warranty below applies to all mowers purchased after January 1, 1991.

Full No-Time-Limit Warranty

What is Covered:

Your TROY-BILT TUFF-CUT® High Wheel Mower is warranted by Garden Way Incorporated to be free from defects in materials and workmanship. This warranty will remain in effect for the life of the machine and will be transferred automatically to any and all subsequent owners.

We or your authorized dealer will repair or replace, at no cost to you, any part we find to be defective with the exception of the engine, which is warranted separately by the engine manufacturer. Garden Way Incorporated does, however, extend the length of the engine manufacturer's warranty, providing you with coverage for a total of three (3) years. (Call or write to us for a FREE copy of the engine warranty.)

This FULL NO-TIME-LIMIT WARRANTY also applies to all non-powered attachments. Powered attachments are warranted separately by their manufacturers.

If we determine them defective, even parts that wear in normal use, such as belts, bearings, blades, tires, and tines are covered under this warranty and will be replaced or repaired without charge. Failures or malfunctions caused by normal wear and tear, use of unauthorized accessories or attachments, misuse, or accident are not covered.

FULL ONE-YEAR COMMERCIAL USE WARRANTY: If used for commercial, institutional, industrial, rental or demonstrator purposes, the warranty on this product is limited in duration to one (1) year from date of purchase. The engine warranty for commercial use is a LIMITED WARRANTY also in effect for one (1) year from date of purchase. Proof of purchase is required to obtain commercial warranty service.

How to Get Service:

To obtain warranty service, contact Garden Way Incorporated at 102nd Street and 9th Avenue, Troy, New York 12180, or call us TOLL-FREE at 1-800-833-6990, or consult your Yellow Pages for the name of the authorized TROY-BILT product dealer nearest you.

Your Rights Under State Law:

This warranty gives you specific legal rights, and you may also have other rights which vary from state to state.



TROY-BILT MANUFACTURING CO., 102nd St. & 9th Ave., Troy, NY 12180
For Technical Service, call Toll-Free: 1-800-833-6990 — For Parts Sales, call Toll-Free: 1-800-648-6776

GARDEN WAY CANADA, INC., 1515 Matheson Blvd. E., Unit B11, Mississauga, Ontario L4W 2P5
Call Toll-Free: 1-800-225-3585

Free Manuals Download Website

<http://myh66.com>

<http://usermanuals.us>

<http://www.somanuals.com>

<http://www.4manuals.cc>

<http://www.manual-lib.com>

<http://www.404manual.com>

<http://www.luxmanual.com>

<http://aubethermostatmanual.com>

Golf course search by state

<http://golfingnear.com>

Email search by domain

<http://emailbydomain.com>

Auto manuals search

<http://auto.somanuals.com>

TV manuals search

<http://tv.somanuals.com>