



# ***Owner's Manual***

- **SET-UP**
- **OPERATION**
- **MAINTENANCE**

**Walk Behind Mower  
Model: T-546**

**IMPORTANT  
Read Safety Rules and  
Instructions Carefully**

**PRINTED IN CANADA**

**OG-4503**

## CALLING CUSTOMER SUPPORT

- **LOCATE YOUR MODEL NUMBER AND SERIAL NUMBER** which appears on your unit and record the information in the space provided below.

**IMPORTANT: You must have these numbers, along with the date and proof of purchase to receive warranty or service.**

- If you are having difficulty assembling this product or if you have any questions regarding the controls, operation or maintenance of this unit, please call an authorized dealer.
- Please have your model number and serial number ready when you call.

**NOTE: Although both numbers are important, you will be asked to enter only your serial number before your call can be processed.**

Model Number Numéro de modèle  XXX-XXXXXX	Serial Number Numéro de série  XXXXXXXXXXXX
<b>TROY-BILT</b> - CANADA KITCHENER, ON N2G 4J1	

— This is where your model number will be, record it here:

— This is where your serial number will be, record Serial Number here:

## TABLE OF CONTENTS

CALLING CUSTOMER SUPPORT . . . . .	2
TABLE OF CONTENTS . . . . .	2
IMPORTANT SAFE OPERATION PRACTICES . . . . .	3
SLOPE GAUGE . . . . .	6
CONTENTS OF HARDWARE PACK . . . . .	7
UNPACKING . . . . .	8
ASSEMBLY . . . . .	8
OPERATION . . . . .	12
ADJUSTMENT . . . . .	13
LUBRICATION . . . . .	14
MAINTENANCE . . . . .	14
OFF SEASON STORAGE INSTRUCTIONS . . . . .	15
REPLACEMENT PARTS . . . . .	16
WARRANTY . . . . .	21
TROUBLE SHOOTING . . . . .	22

*This unit has been inspected against the manufacturer's quality check list. In case of a discrepancy, please call us. We will make every effort to ship the part(s) by courier within one working day of your call.*

---

## IMPORTANT SAFE OPERATION PRACTICES

---



**WARNING:** This symbol points out important safety instructions which, if not followed, could endanger the personal safety and/or property of yourself and others. Read and follow all instructions in this manual before attempting to operate this machine. Failure to comply with these instructions may result in personal injury. When you see this symbol—  heed its warning.



**DANGER:** This machine was built to be operated according to the rules for safe operation in this manual. As with any type of power equipment, carelessness or error on the part of the operator can result in serious injury. This machine is capable of amputating hands and feet and throwing objects. Failure to observe the following safety instructions could result in serious injury or death.

### GENERAL OPERATION

- Read, understand, and follow all instructions on the machine and in the manual(s) before attempting to assemble and operate. Keep this manual in a safe place for future and regular reference and for ordering replacement parts.
- Be familiar with all controls and their proper operation. Know how to stop the machine and disengage them quickly.
- Never allow children under 14 years old to operate this machine. Children 14 years old and over should read and understand the operation instructions and safety rules in this manual and should be trained and supervised by a parent.
- Never allow adults to operate this machine without proper instruction.
- To help avoid blade contact or a thrown object injury, keep bystanders, helpers, children and pets at least 75 feet from the machine while it is in operation. Stop machine if anyone enters the area.
- Thoroughly inspect the area where the equipment is to be used. Remove all stones, sticks, wire, bones, toys and other foreign objects which could be tripped over or picked up and thrown by the blade. Thrown objects can cause serious personal injury.
- Plan your mowing pattern to avoid discharge of material toward roads, sidewalks, bystanders and the like. Also, avoid discharging material against a wall or obstruction which may cause discharged material to ricochet back toward the operator.
- Always wear safety glasses or safety goggles during operation and while performing an adjustment or repair to protect your eyes. Thrown objects which ricochet can cause serious injury to the eyes.
- Wear sturdy, rough-soled work shoes and close-fitting slacks and shirts. Shirts and pants that cover the arms and legs and steel-toed shoes are recommended. Never operate this machine in bare feet, sandals, slippery or light weight (e.g. canvas) shoes.
- Many injuries occur as a result of the mower being pulled over the foot during a fall caused by slipping or tripping. Do not hold on to the mower if you are falling; release the handle immediately.
- Never pull the mower back toward you while you are walking. If you must back the mower away from a wall or obstruction first look down and behind to avoid tripping and then follow these steps:
  - a) Step back from the mower to fully extend your arms.
  - b) Be sure you are well balanced with sure footing
  - c) Pull the mower back slowly, no more than half way toward you.
  - d) Repeat these steps as needed.
- Do not operate the mower while under the influence of alcohol or drugs.
- Do not put hands or feet near rotating parts or under the cutting deck. Contact with the blade can amputate hands and feet.
- A missing or damaged discharge cover can cause blade contact or thrown object injuries.
- Do not engage the self-propelled mechanism on units so equipped while starting engine.
- Never attempt to make a wheel or cutting height adjustment while the engine is running.

- The blade control handle is a safety device. Never attempt to bypass its operation. Doing so makes the safety device inoperative and may result in personal injury through contact with the rotating blade. The blade control handle must operate easily in both directions and automatically return to the disengaged position when released.
- Never operate the mower in wet grass. Always be sure of your footing. A slip and fall can cause serious personal injury. If you feel you are losing your footing, release the blade control handle immediately and the blade will stop rotating within three seconds.
- Mow only in daylight or in good artificial light. Walk, never run.
- Stop the blade when crossing gravel drives, walks or roads.
- If the equipment should start to vibrate abnormally, stop the engine and check immediately for the cause. Vibration is generally a warning of trouble.
- Shut the engine off and wait until the blade comes to a complete stop before removing the grass catcher or unclogging the chute. The cutting blade continues to rotate for a few seconds after the engine is shut off. Never place any part of the body in the blade area until you are sure the blade has stopped rotating.
- Never operate mower without proper trail shield, discharge cover, grass catcher, blade control handle or other safety protective devices in place and working. Never operate mower with damaged safety devices. Failure to do so, can result in personal injury.
- Muffler and engine become hot and can cause a burn. Do not touch.
- Only use parts and accessories made for this machine by the manufacturer. Failure to do so, can result in personal injury.
- If situations occur which are not covered in this manual, use care and good judgment. Contact your customer support department.

#### **SLOPE OPERATION**

Slopes are a major factor related to slip and fall accidents which can result in severe injury. Operation on slopes requires extra caution. If you feel uneasy on a slope, do not mow it. For your safety, use the slope gauge included as part of this manual to measure slopes before operating this unit on a sloped or hilly area. If the slope is greater than 15 degrees, do not mow it.

#### **DO:**

- Mow across the face of slopes; never up and down. Exercise extreme caution when changing direction on slopes. Watch for holes, ruts, bumps, rocks, or other hidden objects which can cause you to slip or trip. Tall grass can hide obstacles. Always be sure of your footing. A slip and fall can cause serious personal injury. If you feel you are losing your balance, release the blade control handle immediately, and the blade will stop rotating within 3 seconds.

#### **DO NOT:**

- Do not mow near drop-offs, ditches or embankments, you could lose your footing or balance.
- Do not mow slopes greater than 15 degrees as shown on the slope gauge.
- Do not mow on wet grass. Unstable footing could cause slipping.

#### **CHILDREN**

- Tragic accidents can occur if the operator is not alert to the presence of children. Children are often attracted to the mower and the mowing activity. They do not understand the dangers. Never assume that children will remain where you last saw them.
  - a) Keep children out of the mowing area and under the watchful care of a responsible adult other than the operator.
  - b) Be alert and turn mower off if a child enters the area.
  - c) Before and while moving backwards, look behind and down for small children.
  - d) Use extreme care when approaching blind corners, doorways, shrubs, trees, or other objects that may obscure your vision of a child who may run into the mower.
  - e) Keep children away from hot or running engines. They can suffer burns from a hot muffler.
- Never allow children under 14 years old to operate a power mower. Children 14 years old and over should read and understand the operation instructions and safety rules in this manual and should be trained and supervised by a parent.

#### **SERVICE SAFE HANDLING OF GASOLINE:**

- To avoid personal injury or property damage use extreme care in handling gasoline. Gasoline is extremely flammable and the vapors are explosive. Serious personal injury can occur when gasoline is spilled on your-

self or your clothes which can ignite. Wash your skin and change clothes immediately.

- a) Use only an approved gasoline container.
- b) Never fill containers inside a vehicle or on a truck or trailer bed with a plastic liner. Always place containers on the ground away from your vehicle before filling.
- c) When practical, remove gas-powered equipment from the truck or trailer and refuel it on the ground. If this is not possible, then refuel such equipment on a trailer with a portable container, rather than from a gasoline dispenser nozzle.
- d) Keep the nozzle in contact with the rim of the fuel tank or container opening at all times until fueling is complete. Do not use a nozzle lock-open device.
- e) Extinguish all cigarettes, cigars, pipes and other sources of ignition.
- f) Never fuel machine indoors.
- g) Never remove gas cap or add fuel while the engine is hot or running. Allow engine to cool at least two minutes before refueling.
- h) Never over fill fuel tank. Fill tank to no more than 1/2 inch below bottom of filler neck to provide space for fuel expansion.
- i) Replace gasoline cap and tighten securely.
- j) If gasoline is spilled, wipe it off the engine and equipment. Move unit to another area. Wait 5 minutes before starting the engine.
- k) Never store the machine or fuel container inside where there is an open flame, spark or pilot light as on a water heater, space heater, furnace, clothes dryer or other gas appliances.
- l) To reduce fire hazard, keep machine free of grass, leaves, or other debris build-up. Clean up oil or fuel spillage and remove any fuel soaked debris.
- m) Allow machine to cool at least 5 minutes before storing.

#### GENERAL SERVICE:

- Never run an engine indoors or in a poorly ventilated area. Engine exhaust contains carbon monoxide, an odorless and deadly gas.
- Before cleaning, repairing, or inspecting, make certain the blade and all moving parts have stopped. Disconnect the spark plug wire and ground against the engine to prevent unintended starting.
- Check the blade and engine mounting bolts at frequent intervals for proper tightness. Also, visually inspect blade for damage (e.g., bent, cracked, worn) Replace blade with the original equipment manufacturer's (O.E.M.) blade only, listed in this manual. "Use of parts which do not meet the original equipment specifications may lead to improper performance and compromise safety!"
- Mower blades are sharp and can cut. Wrap the blade(s) or wear gloves, and use extra caution when servicing them.
- Keep all nuts, bolts, and screws tight to be sure the equipment is in safe working condition.
- Never tamper with safety devices. Check their proper operation regularly.
- After striking a foreign object, stop the engine, disconnect the spark plug wire and ground against the engine. Thoroughly inspect the mower for any damage. Repair the damage before starting and operating the mower.
- Grass catcher components, discharge cover, and trail shield are subject to wear and damage which could expose moving parts or allow objects to be thrown. For safety protection, frequently check components and replace immediately with original equipment manufacturer's (O.E.M.) parts only, listed in this manual. "Use of parts which do not meet the original equipment specifications may lead to improper performance and compromise safety!"
- Do not change the engine governor setting or overspeed the engine. The governor controls the maximum safe operating speed of the engine.
- Maintain or replace safety and instruction labels, as necessary.
- Observe proper disposal laws and regulations. Improper disposal of fluids and materials can harm the environment.

SI-102  
12.06.02



**WARNING - Your Responsibility:**  
Restrict the use of this power machine to persons who read, understand and follow the warnings and instructions in this manual and on the machine.

# SLOPE GAUGE

(Keep this sheet in a safe place for future reference.)

USE THIS SHEET AS A GUIDE TO DETERMINE SLOPES WHERE YOU MAY NOT OPERATE SAFELY.

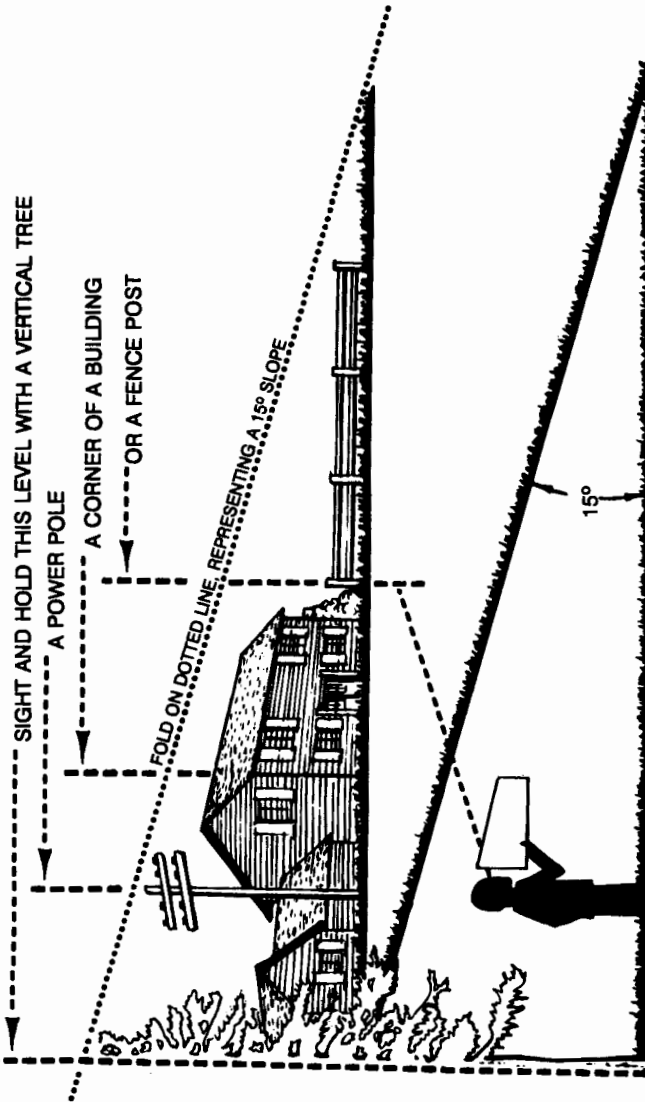

**⚠ DANGER**

Do not mow on inclines with a slope in excess of 15 degrees (a rise of approximately 2½ feet every 10 feet). A riding mower could overturn and cause serious injury. If operating a walk-behind mower on such a slope, it is extremely difficult to maintain your footing and you could slip, resulting in serious injury.

Operate RIDING mowers up and down slopes, never across the face of slopes.

Operate WALK-BEHIND mowers across the face of slopes, never up and down slopes.

## CONTENTS OF HARDWARE PACK

Lay out the hardware according to the illustration for identification purposes. Part numbers are shown in parentheses. (Some parts may not be required for your unit.)

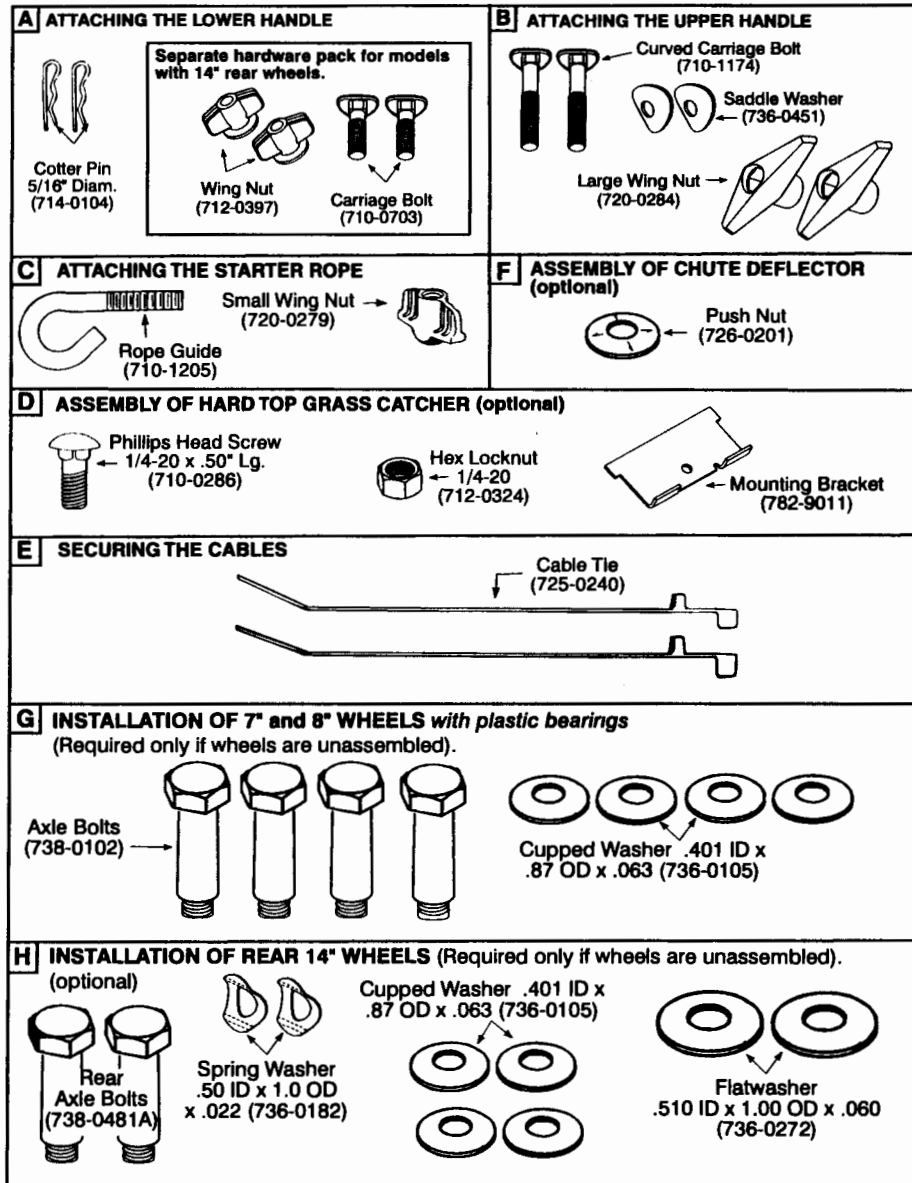

It is suggested that this manual be read in its entirety before attempting to assemble or operate. Keep this manual in a safe place for future reference and for ordering replacement parts.

This unit is shipped **WITHOUT GASOLINE or OIL**. After assembly, service engine with gasoline and oil as instructed in the separate engine manual packed with your unit.

#### Tools Required for Assembly

(1) 7/16" Wrench                      (1) 3/4" Wrench

### UNPACKING

Remove the lawn mower and all parts from the carton. Make certain all parts and literature have been removed from the carton before the carton is discarded.

**CAUTION: DISCONNECT SPARK PLUG WIRE. IF THE WIRE IS NOT EQUIPPED WITH A RUBBER BOOT, SEE SEPARATE ENGINE MANUAL FOR GROUNDING PROCEDURE.**

**CAUTION: DO NOT BEND OR KINK CONTROL WIRE.**

Refer to "Contents of Hardware Pack".

### ASSEMBLY

#### ATTACHING THE LOWER HANDLE (Hardware A)

There is an off-set hole in the lower handle to provide you with two handle height adjustments. Handles mounted with the notch (see inset, figure 1A) forward or upward will be lower than handles mounted with the notch towards the rear of the unit.

Place the lower handle assembly on the mower. The holes in the handle fit over the pins on the deck bracket.

Secure with cotter pins in the inner holes in the weld pins. See figures 1A or 1B.

#### For Models with 14" rear wheels.

After you have moved the hairpin clips as shown in Figure 1B, place one carriage bolt (found in the hardware pack included with your unit) in the upper hole of the right handle mounting bracket from the inside outward. Secure with one plastic wing nut. Repeat process on the left side.

#### ATTACHING THE UPPER HANDLE (Hardware B)

Place the upper handle in position over the lower handle. The blade control must be on

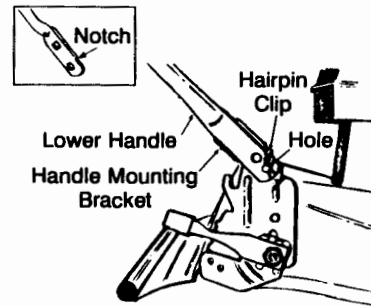
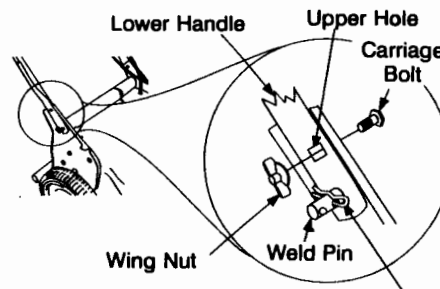

Figure 1A- For models with 8" rear wheels.



Place the hairpin clips in the inner hole.

Figure 1B-For models with 14: rear wheels.

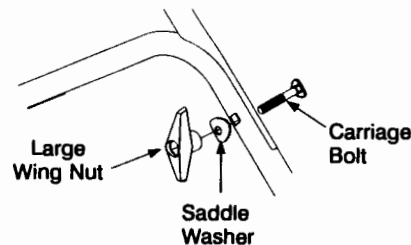

Figure 2

the upper side of the handle and the bracket should be on the left side.

- Secure the upper handle to the lower handle using curved carriage bolts, saddle washers and large wing nuts, see figure 2.

**NOTE:** Wing nuts should be mounted on the inside.

#### ATTACHING THE BLADE CONTROL CABLE

- Make certain the blade control handle is on top of the upper handle.



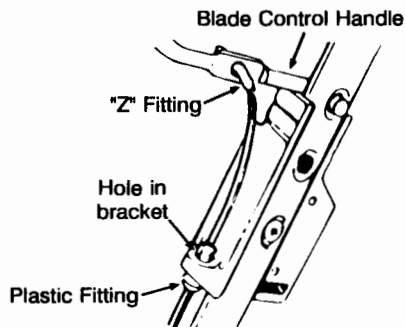

Figure 3

the brake cable over the lower handle. Place end of cable through the hole in the bracket as shown in figure 3. Push the plastic fitting until it locks into the hole.

- Move the blade control handle away from the upper handle. Hook the "Z" end of the brake cable into the hole in the blade control handle from the outside to the inside as shown in figure 3.

**! WARNING:** Brake cable must be assembled as shown for proper blade brake operation.

#### ATTACHING THE STARTER ROPE (Hardware C)

- The starter rope is inside the top of the engine. Additional rope may be wound around the starter handle. If so, unwind the rope from the handle.
- With the spark plug wire disconnected and grounded as instructed in the separate engine manual, hold the blade control handle against the upper handle and pull the rope out of the engine.
- Place the rope guide around the starter handle, so the opening in the rope guide is toward the front of the mower as shown. Insert the rope guide into the right side of the handle.
- Secure with small wing nut. See figure 4.

**NOTE:** If the starter rope becomes disconnected from rope guide on handle, disconnect and ground the spark plug wire. Depress the blade control handle and pull the starter rope out from engine slowly. Slip the starter rope into the rope guide bolt on handle.

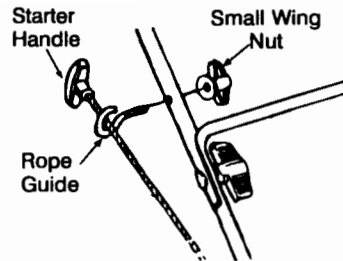

Figure 4

#### SECURING THE CABLES (Hardware E)

Secure the cable to the left side of the handle as follows.

**! WARNING:** When attaching the control cables, the cables must be routed to avoid contact with all sharp edges and hot surfaces to prevent damage to the cables, which will render the control inoperative.

- Insert posts on cable ties into holes provided on the handle, one on each the upper handle and lower handle. The holes may be either on the inside or outside of the handles. See figure 5A.
- Secure the cables with the cable ties. See figure 5B. Trim excess ends of cable ties.

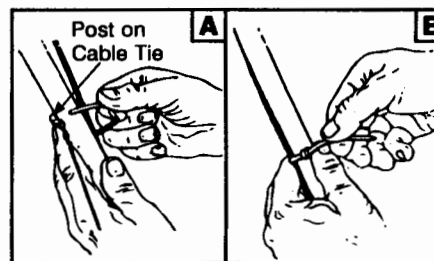
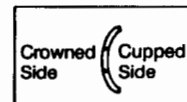

Figure 5

#### INSTALLATION OF 7" and 8" WHEELS (Optional) (Hardware G)

- Insert axle bolts (with the longest threads) through wheels followed by cupped washers (crowned side of washers go against the wheels).
- Attach the wheels to the pivot bar on the height adjusters. Use the upper hole in the pivot bar when assembling 8" wheels. See figure 6 and 7.



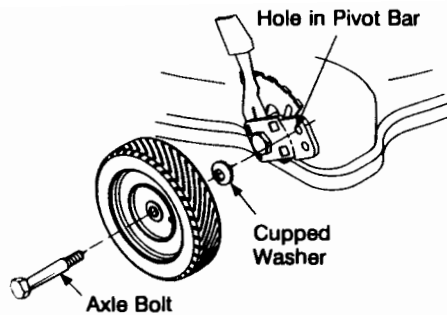

Figure 6 - 7" and 8" Front Wheel

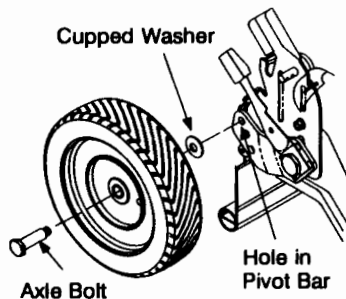

Figure 7 - 8" Rear Wheel

**NOTE: Tighten axle bolts until cupped washers flatten.**

#### INSTALLATION OF 14" REAR WHEELS (Optional) (Hardware H)

Place the axle bolt through the large flat washer followed by the spring washer, wheel assembly and cupped washer as shown in figure 8.

Attach the wheels to the pivot bar on the height adjusters. Use the lower hole in the pivot bar when assembly 14" wheels.

**NOTE: Tighten axle bolts until cupped washers flatten.**

#### ASSEMBLY OF CHUTE DEFLECTOR (Optional) (Hardware F)

Slide the rod into the upper edge of the chute deflector so the tab on the rod is toward the left side of the chute deflector. When assembled correctly, the rod will extend further to the left side than the right side. See figure 9.

Slide the push nut onto the right side of the rod to secure.

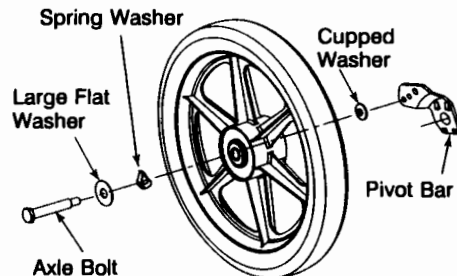

Figure 8-Models with 14" rear wheels.

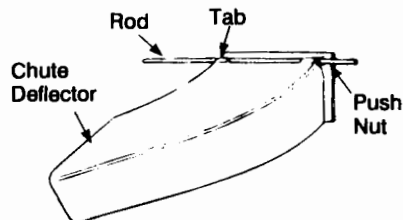

Figure 9

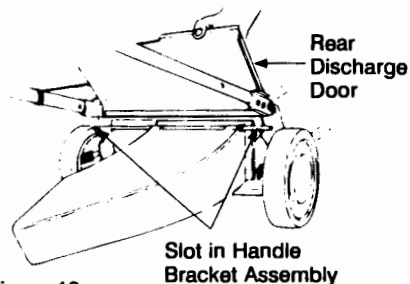

Figure 10

#### ATTACHING CHUTE DEFLECTOR TO MOWER

Lift the rear discharge door on the mower. Place the ends of the rod into the slots in the handle bracket assemblies. See figure 10. Release the rear discharge door.

To remove the chute deflector, lift the rear discharge door on the mower. Lift the chute deflector up, out of the slots in the handle bracket assemblies. Release the rear discharge door.

**CAUTION: Do not run your lawn mower without chute deflector or an approved grass catcher in place. The deflector will deflect a projectile thrown by the blade into the lawn.**

## FINAL ASSEMBLY OF MOWER

Make certain all nuts and bolts are tightened securely.

### ASSEMBLY OF GRASS CATCHER

#### (Soft Grass Bag)

**NOTE:** Make certain the grass bag is turned right side out before assembling (warning label will be on the outside).

- Join the rear frame and front frame assembly as shown in figure 11A.
- Place bag over frame (black plastic side is the bottom of bag.) Slip the openings in the side of the plastic channel on bag over the hooks on the grass catcher frame.
- Secure bag to frame by working the plastic channels on bag over frame as shown in figure 11B. All of the plastic channels except center top of bag attach from the outside of bag. Center top of bag attaches from the inside of bag.

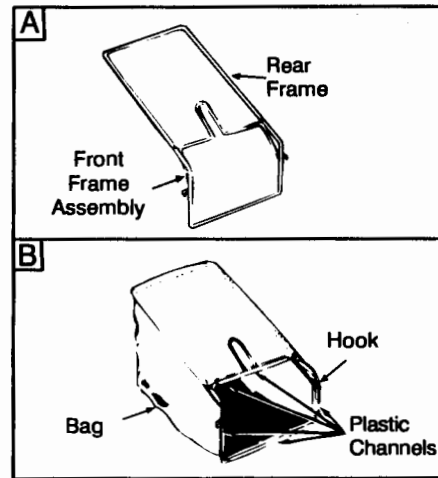

Figure 11

### ATTACHING GRASS CATCHER TO MOWER

- Lift the rear discharge door on the mower, and remove the rear mulching plug. See figure 12.

**NOTE:** Make certain cables are routed to the outside of the handle so they are not in the way when attaching the grass catcher.

- **For Models with 8" rear wheels.** Place the hooks on the grass catcher into the slots in the handle bracket assemblies. See figure 13. Release the rear discharge door.
- **For Models with 14" rear wheels.** Place the hooks on the grass catcher over the rear door hinge rod. See figure 14. Release the rear discharge door.

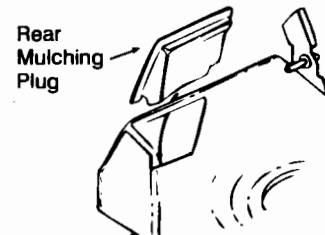

Figure 12

### TO REMOVE THE GRASS CATCHER

**For Models with 8" rear wheels.** Lift the rear discharge door on the mower. Lift the grass catcher up, out of the slots in the handle bracket assemblies. Release the rear discharge door. See figure 13.

**For Models with 14" rear wheels.** Lift the rear discharge door on the mower. Lift the grass catcher up and off the rear door hinge rod. Release the rear discharge door. See figure 14.

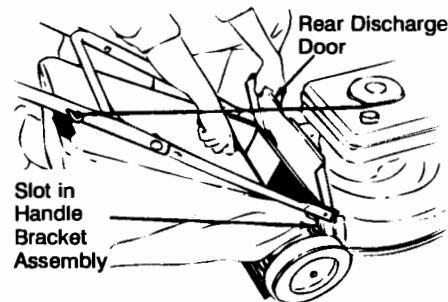

Figure 13-For Models with 8" rear wheels.

**WARNING:** Never operate the mower unless the hooks on the grass catcher are seated in the slots on the handle bracket assemblies, and the rear discharge door rests firmly against the top of the grass catcher.

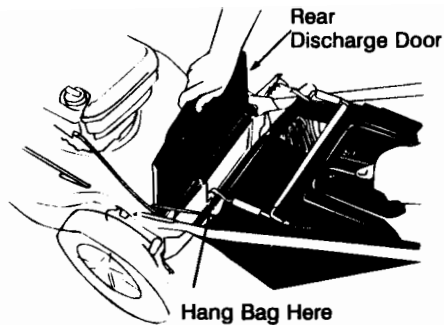

Figure 14-For Models with 14" rear wheels.

#### CONVERTING TO SIDE DISCHARGE

If your unit is equipped with a side discharge deflector, you can convert to a side discharge mower as follows:

Lift the rear discharge door and install the rear mulching plug. See Figure 12.

On the side of the mower deck, lift the hinged mulching plug. See Figure 15.

Slide the two hooks on the side discharge deflector under the hinge pin on the hinged mulching plug assembly.

Lower the hinged mulching plug.

**NOTE:** Do not remove the hinged mulching plug at any time, even when you are not mulching.

**WARNING:** All mowers are equipped with a rear protective guard. The guard helps eliminate projectiles thrown by the blade from injuring the operator. **DO NOT REMOVE THIS GUARD.**

Hinged Mulching Plug

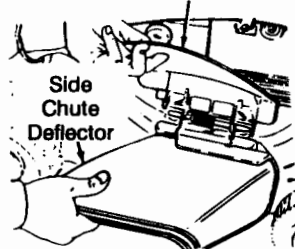

Figure 15

### OPERATION

#### BEFORE STARTING

Service the engine with gasoline and oil as instructed in the separate engine manual packed in your mower. Read instructions carefully.

**WARNING:** Never fill fuel tank indoors, with engine running or until the engine has been allowed to cool for at least two minutes after running.

#### TO START ENGINE AND ENGAGE BLADE

- Attach spark plug wire to spark plug. If unit is equipped with a rubber boot over the end of the spark plug wire, make certain the metal loop on the end of the spark plug wire (inside the rubber boot) is fastened securely over the metal tip on the spark plug. See figure 16.

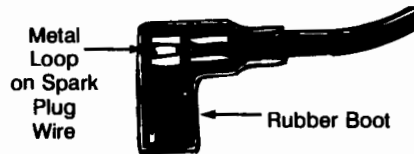

Figure 16

- If your unit is equipped with a primer, prime engine as instructed in the separate engine manual packed with your unit.
- If your unit is equipped with a throttle control, move the throttle lever to the FAST position as instructed in the separate engine manual packed with your unit.
- Standing behind the unit, depress the blade control handle and hold it against the upper handle as shown in Figure 17.
- Grasp the recoil starter handle as shown and pull up rapidly. Return it slowly to the rope guide bolt.

The blade control handle must be depressed in order to operate the unit. Release the blade control handle to stop the engine and blade.

#### TO STOP ENGINE :

- Release the blade control handle to stop the engine and blade.

**WARNING:** The blade continues to rotate for a few seconds after the engine is shut off.

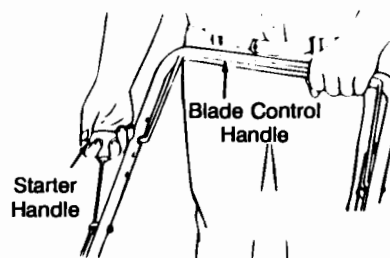

Figure 17

- Disconnect and ground the spark plug wire as instructed in the separate engine manual to prevent accidental starting while equipment is unattended.

To remove the mulching kit, simply lift up rear discharge door and remove the rear mulching plug. See figure 12. Then attach the grass catcher (optional equipment).



**WARNING:** Your mower is designed to cut normal residential grass of a height no more than 10". Do not attempt to mow through unusually tall, dry grass (e.g., pasture) or piles of dry leaves. Debris may build up on the mower deck or contact the engine exhaust presenting a potential fire hazard.

#### FOR THE BEST RESULTS WHEN MULCHING:

- **Clear lawn of debris.** Be sure that the lawn is clear of stones, sticks, wire or other foreign objects which could damage the lawnmower. Such objects could be accidentally thrown out by the mower in any direction and cause serious personal injury to the operator and others as well as damage to property and surrounding objects.
- **Do not cut wet grass.** For effective mulching do not cut wet grass because it tends to stick to the underside of the deck preventing proper mulching of the grass clippings.
- **Cut no more than 1/3 the length of the grass.** The recommended cut for mulching is 1/3 the length of the grass. Ground speed will need to be adjusted so the clippings can be dispersed evenly into the lawn. For especially heavy cutting in thick grass it may be necessary to use one of the slowest speeds in order to get a clean well mulched cut. When mulching long grass you may have to cut the lawn in two passes, lowering the blade another 1/3 of the length for the second cut and perhaps cutting in a different pattern than was used the first time. Overlapping the cut a little on each pass will also help to clean up any stray clippings left on the lawn. The mower should always be operated at full throttle to get the best cut and allow it to do the most effective job of mulching.
- **Clean underside of deck.** Be certain to clean the underside of the cutting deck after each use to avoid a build-up of grass, which would prevent proper mulching.
- **Mulching Leaves.** The mulching of leaves can also be beneficial to your lawn. When mulching leaves make sure they are dry and are not laying too thick on the lawn. Do not wait for all the leaves to be off the trees before you mulch.

- It is recommended keeping driveways and sidewalks on the operators right while moving. Continue mowing using this pattern, having the left side of your lawnmower next to the uncut grass. Mulching with the cutting area of the mower on the lawn avoids grass clippings in undesirable areas.



**WARNING:** If you strike a foreign object, stop the engine. Remove wire from spark plug, thoroughly inspect the mower for any damage, and repair the damage before restarting and operating the mower. Extensive vibration of the mower during operation is an indication of damage. The unit should be promptly inspected and repaired.

#### DECK

The underside of the mower deck should be cleaned after each use to prevent a buildup of grass clippings, leaves, dirt or other matter. If this debris is allowed to accumulate, it will invite rust and corrosion, and may prevent proper mulching.

The deck may be cleaned by tilting the mower and scraping clean with a suitable tool (make certain the spark plug wire is disconnected).

#### ADJUSTMENT

**CAUTION : DO NOT AT ANY TIME MAKE ANY ADJUSTMENT TO LAWNMOWER WITHOUT FIRST STOPPING THE ENGINE AND DISCONNECTING THE SPARK PLUG WIRE .**

**CAUTION : Before changing mowing height, stop mower and disconnect spark plug cable.**

#### MODELS WITH NINE POSITION HEIGHT ADJUSTERS: (See Figure 18).

- Stop mower and disconnect spark plug cable before changing mower cutting height.
- The wheel adjusters give you nine (9) different cutting positions. Medium is the best for most mowers.
- To change the height of cut, squeeze adjuster lever toward the wheel, moving up or down to selected height.



Figure 18

**NOTE: All wheels must be in the same height of cut.**

When cutting in heavy or moist grass, the rear of lawnmower may be raised higher to allow better discharge of the grass.

### CARBURETOR ADJUSTMENT

Minor carburetor adjustment may be required to compensate for differences in fuel, temperature, altitude and load. Refer to the separate engine manual packed with your mower for carburetor adjustment information.

### HANDLE HEIGHT ADJUSTMENT

Your mower has provisions for two handle height positions. The notch on the flat portion of the lower handle indicates which position the handle is in. If the notch is facing up or forward the handle is in the lower height and for the higher height the notch is facing down.

To change the height setting refer to "Attaching the Lower Handle".

## LUBRICATION

**CAUTION: DISCONNECT SPARK PLUG WIRE BEFORE SERVICING.**

**WHEELS** - Lubricate the ball bearings in each wheel at least once a season with a light oil.

**ENGINE** - Follow engine manual for lubrication instructions.

**BLADE CONTROL** - Lubricate the pivot points on the blade control handle and the brake cable at least once a season with light oil. The blade control must operate freely in both directions.

## MAINTENANCE

### CUTTING BLADE

**WARNING:** Be sure to disconnect and ground the spark plug wire before working on the cutting blade to prevent accidental engine starting. Protect hands by using heavy gloves or a rag to grasp the cutting blades.

Tip mower as specified in separate engine manual. If it is not specified tip with carburetor up.

Remove the bolt and blade support which holds the blade and adapter to the engine crankshaft. Remove the blade and adapter from the crankshaft. See Figure 19.

**WARNING:** Periodically inspect the blade adapter for cracks, especially if you strike a foreign object. Replace when necessary.

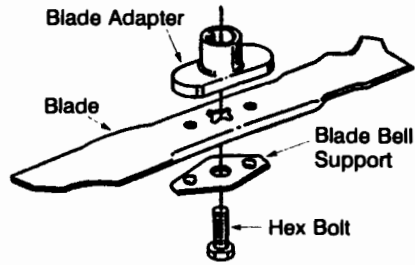

Figure 19

For best results your blade should be sharp. The blade may be resharpened by removing it and either grinding or filing the cutting edge keeping as close to the original bevel as possible. **It is extremely important that each cutting edge receives an equal amount of grinding** to prevent an unbalanced blade. Improper blade balance will result in excessive vibration causing eventual damage to the engine and mower. Be sure to carefully balance blade after sharpening. The blade can be tested for balance by balancing it on a round shaft screwdriver. Remove metal from the heavy side until it balances evenly.

Before reassembling the blade and the blade adapter to the unit, lubricate the engine crankshaft and the inner surface of the blade adapter with light oil. Install the blade adapter on the crankshaft with the "star" away from the engine. Refer to figure 19. Place the blade with the side marked bottom (or with part number) facing away from the adapter. Align the blade bell support over the blade with the tabs in the holes of the blade and insert the hex bolt. Tighten the hex bolt to the torque listed below:

### Blade Mounting Torque

Center Bolt 450 in. lb. min., 600 in.lb. max.

To insure safe operation of your unit, ALL nuts and bolts must be checked periodically for correct tightness.

**CAUTION:** Cutting grass in sandy soil condition causes abrasive wear to the blades.

After prolonged use, especially in sandy soil conditions, the blade will become worn and lose some of the original shape. Cutting efficiently will be reduced and the blade should be replaced. Replace with an approved factory replacement blade only. Possible damage resulting from blade unbalance condition is not the responsibility of the manufacturer.

## ENGINE

Refer to the separate engine manual for engine maintenance instructions.

Maintain **engine oil** as instructed in the separate engine manual packed with your unit. Read and follow instructions carefully.

Service **air cleaner** as per separate engine manual under normal conditions. Clean every few hours under extremely dusty conditions. Poor engine performance and flooding usually indicates that the air cleaner should be serviced. To service the air cleaner, refer to the separate engine manual packed with your unit.

The **spark plug** should be cleaned and the gap reset once a season. Spark plug replacement is recommended at the start of each mowing season; check engine manual for correct plug type and gap specifications.

**NOTE:** This spark ignition system meets all requirements of the Canadian Interference-Causing Equipment Regulations.

Clean the engine regularly with a cloth or brush. Keep the cooling system (blower housing area) clean to permit proper air circulation which is essential to engine performance and life. Be certain to remove all grass, dirt and combustible debris from muffler area.

---

## OFF SEASON STORAGE INSTRUCTIONS

---

The following steps should be taken to prepare lawn mower for storage.

- Clean and lubricate mower thoroughly as described in the lubrication instructions.
- Refer to engine manual for correct engine storage instructions.
- Coat mower's cutting blade with chassis grease to prevent rusting.
- Store mower in a dry, clean area.

**NOTE:** When storing any type of power equipment in an unventilated or metal storage shed, care should be taken to rust-proof the equipment. Using a light oil or silicone, coat the equipment, especially cables and all moving parts.

**NOTE:** Be careful not to bend or kink cables.

**NOTE:** If the starter rope becomes disconnected from rope guide on handle, disconnect and ground the spark plug wire. Depress the blade control handle and pull the starter rope out from engine slowly. Slip the starter rope into the rope guide bolt on handle.

## Free Manuals Download Website

<http://myh66.com>

<http://usermanuals.us>

<http://www.somanuals.com>

<http://www.4manuals.cc>

<http://www.manual-lib.com>

<http://www.404manual.com>

<http://www.luxmanual.com>

<http://aubethermostatmanual.com>

Golf course search by state

<http://golfingnear.com>

Email search by domain

<http://emailbydomain.com>

Auto manuals search

<http://auto.somanuals.com>

TV manuals search

<http://tv.somanuals.com>