



Owner's Manual

- **SET-UP**
- **OPERATION**
- **MAINTENANCE**

**Walk Behind Mower
Model: T-976**

**IMPORTANT
Read Safety Rules and
Instructions Carefully**

PRINTED IN CANADA

OG-4203

CALLING CUSTOMER SUPPORT

- **LOCATE YOUR MODEL NUMBER AND SERIAL NUMBER** which appears on your unit and record the information in the space provided below.

IMPORTANT: You must have these numbers, along with the date and proof of purchase to receive warranty or service.

- If you are having difficulty assembling this product or if you have any questions regarding the controls, operation or maintenance of this unit, please call an authorized dealer.
- Please have your model number and serial number ready when you call.

NOTE: Although both numbers are important, you will be asked to enter only your serial number before your call can be processed.

Model Number Numéro de modèle XXX-XXXXXX	Serial Number Numéro de série XXXXXXXXXXXX
TROY-BILT TROYBILT - CANADA KITCHENER, ON N2G 4J1	

— This is where your model number will be, record it here:

— This is where your serial number will be, record Serial Number here:

TABLE OF CONTENTS

CALLING CUSTOMER SUPPORT	2
IMPORTANT SAFE OPERATION PRACTICES	3
SLOPE GAUGE	6
CONTROLS	7
SET-UP INSTRUCTIONS	7
OPERATION	9
ADJUSTMENT	12
LUBRICATION	13
MAINTENANCE	14
OFF SEASON STORAGE INSTRUCTIONS	17
REPLACEMENT PARTS	18
WARRANTY:	29
TROUBLE SHOOTING	30

This unit has been inspected against the manufacturers quality check list. In case of a discrepancy, please call us. We will make every effort to ship the part(s) by courier within one working day of your call.

IMPORTANT SAFE OPERATION PRACTICES



WARNING: This symbol points out important safety instructions which, if not followed, could endanger the personal safety and/or property of yourself and others. Read and follow all instructions in this manual before attempting to operate this machine. Failure to comply with these instructions may result in personal injury. When you see this symbol—  heed its warning.



DANGER: This machine was built to be operated according to the rules for safe operation in this manual. As with any type of power equipment, carelessness or error on the part of the operator can result in serious injury. This machine is capable of amputating hands and feet and throwing objects. Failure to observe the following safety instructions could result in serious injury or death.

GENERAL OPERATION

- Read, understand, and follow all instructions on the machine and in the manual(s) before attempting to assemble and operate. Keep this manual in a safe place for future and regular reference and for ordering replacement parts.
- Be familiar with all controls and their proper operation. Know how to stop the machine and disengage them quickly.
- Never allow children under 14 years old to operate this machine. Children 14 years old and over should read and understand the operation instructions and safety rules in this manual and should be trained and supervised by a parent.
- Never allow adults to operate this machine without proper instruction.
- To help avoid blade contact or a thrown object injury, keep bystanders, helpers, children and pets at least 75 feet from the machine while it is in operation. Stop machine if anyone enters the area.
- Thoroughly inspect the area where the equipment is to be used. Remove all stones, sticks, wire, bones, toys and other foreign objects which could be tripped over or picked up and thrown by the blade. Thrown objects can cause serious personal injury.
- Plan your mowing pattern to avoid discharge of material toward roads, sidewalks, bystanders and the like. Also, avoid discharging material against a wall or obstruction which may cause discharged material to ricochet back toward the operator.
- Always wear safety glasses or safety goggles during operation and while performing an adjustment or repair to protect your eyes. Thrown objects which ricochet can cause serious injury to the eyes.
- Wear sturdy, rough-soled work shoes and close-fitting slacks and shirts. Shirts and pants that cover the arms and legs and steel-toed shoes are recommended. Never operate this machine in bare feet, sandals, slippery or light weight (e.g. canvas) shoes.
- Many injuries occur as a result of the mower being pulled over the foot during a fall caused by slipping or tripping. Do not hold on to the mower if you are falling; release the handle immediately.
- Never pull the mower back toward you while you are walking. If you must back the mower away from a wall or obstruction first look down and behind to avoid tripping and then follow these steps:
 - a) Step back from the mower to fully extend your arms.
 - b) Be sure you are well balanced with sure footing
 - c) Pull the mower back slowly, no more than half way toward you.
 - d) Repeat these steps as needed.
- Do not operate the mower while under the influence of alcohol or drugs.
- Do not put hands or feet near rotating parts or under the cutting deck. Contact with the blade can amputate hands and feet.
- A missing or damaged discharge cover can cause blade contact or thrown object injuries.
- Do not engage the self-propelled mechanism on units so equipped while starting engine.
- Never attempt to make a wheel or cutting height adjustment while the engine is running.

- The blade control handle is a safety device. Never attempt to bypass its operation. Doing so makes the safety device inoperative and may result in personal injury through contact with the rotating blade. The blade control handle must operate easily in both directions and automatically return to the disengaged position when released.
- Never operate the mower in wet grass. Always be sure of your footing. A slip and fall can cause serious personal injury. If you feel you are losing your footing, release the blade control handle immediately and the blade will stop rotating within three seconds.
- Mow only in daylight or in good artificial light. Walk, never run.
- Stop the blade when crossing gravel drives, walks or roads.
- If the equipment should start to vibrate abnormally, stop the engine and check immediately for the cause. Vibration is generally a warning of trouble.
- Shut the engine off and wait until the blade comes to a complete stop before removing the grass catcher or unclogging the chute. The cutting blade continues to rotate for a few seconds after the engine is shut off. Never place any part of the body in the blade area until you are sure the blade has stopped rotating.
- Never operate mower without proper trail shield, discharge cover, grass catcher, blade control handle or other safety protective devices in place and working. Never operate mower with damaged safety devices. Failure to do so, can result in personal injury.
- Muffler and engine become hot and can cause a burn. Do not touch.
- Only use parts and accessories made for this machine by the manufacturer. Failure to do so, can result in personal injury.
- If situations occur which are not covered in this manual, use care and good judgment. Contact your customer support department.

SLOPE OPERATION

Slopes are a major factor related to slip and fall accidents which can result in severe injury. Operation on slopes requires extra caution. If you feel uneasy on a slope, do not mow it. For your safety, use the slope gauge included as part of this manual to measure slopes before operating this unit on a sloped or hilly area. If the slope is greater than 15 degrees, do not mow it.

DO:

- Mow across the face of slopes; never up and down. Exercise extreme caution when changing direction on slopes. Watch for holes, ruts, bumps, rocks, or other hidden objects which can cause you to slip or trip. Tall grass can hide obstacles. Always be sure of your footing. A slip and fall can cause serious personal injury. If you feel you are losing your balance, release the blade control handle immediately, and the blade will stop rotating within 3 seconds.

DO NOT:

- Do not mow near drop-offs, ditches or embankments, you could lose your footing or balance.
- Do not mow slopes greater than 15 degrees as shown on the slope gauge.
- Do not mow on wet grass. Unstable footing could cause slipping.

CHILDREN

- Tragic accidents can occur if the operator is not alert to the presence of children. Children are often attracted to the mower and the mowing activity. They do not understand the dangers. Never assume that children will remain where you last saw them.
 - a) Keep children out of the mowing area and under the watchful care of a responsible adult other than the operator.
 - b) Be alert and turn mower off if a child enters the area.
 - c) Before and while moving backwards, look behind and down for small children.
 - d) Use extreme care when approaching blind corners, doorways, shrubs, trees, or other objects that may obscure your vision of a child who may run into the mower.
 - e) Keep children away from hot or running engines. They can suffer burns from a hot muffler.
- Never allow children under 14 years old to operate a power mower. Children 14 years old and over should read and understand the operation instructions and safety rules in this manual and should be trained and supervised by a parent.

SERVICE SAFE HANDLING OF GASOLINE:

- To avoid personal injury or property damage use extreme care in handling gasoline. Gasoline is extremely flammable and the vapors are explosive. Serious personal injury can occur when gasoline is spilled on your-

self or your clothes which can ignite. Wash your skin and change clothes immediately.

- a) Use only an approved gasoline container.
- b) Never fill containers inside a vehicle or on a truck or trailer bed with a plastic liner. Always place containers on the ground away from your vehicle before filling.
- c) When practical, remove gas-powered equipment from the truck or trailer and refuel it on the ground. If this is not possible, then refuel such equipment on a trailer with a portable container, rather than from a gasoline dispenser nozzle.
- d) Keep the nozzle in contact with the rim of the fuel tank or container opening at all times until fueling is complete. Do not use a nozzle lock-open device.
- e) Extinguish all cigarettes, cigars, pipes and other sources of ignition.
- f) Never fuel machine indoors.
- g) Never remove gas cap or add fuel while the engine is hot or running. Allow engine to cool at least two minutes before refueling.
- h) Never over fill fuel tank. Fill tank to no more than $\frac{1}{2}$ inch below bottom of filler neck to provide space for fuel expansion.
- i) Replace gasoline cap and tighten securely.
- j) If gasoline is spilled, wipe it off the engine and equipment. Move unit to another area. Wait 5 minutes before starting the engine.
- k) Never store the machine or fuel container inside where there is an open flame, spark or pilot light as on a water heater, space heater, furnace, clothes dryer or other gas appliances.
- l) To reduce fire hazard, keep machine free of grass, leaves, or other debris build-up. Clean up oil or fuel spillage and remove any fuel soaked debris.
- m) Allow machine to cool at least 5 minutes before storing.

GENERAL SERVICE:

- Never run an engine indoors or in a poorly ventilated area. Engine exhaust contains carbon monoxide, an odorless and deadly gas.
- Before cleaning, repairing, or inspecting, make certain the blade and all moving parts have stopped. Disconnect the spark plug wire and ground against the engine to prevent unintended starting.
- Check the blade and engine mounting bolts at frequent intervals for proper tightness. Also, visually inspect blade for damage (e.g., bent, cracked, worn) Replace blade with the original equipment manufacturer's (O.E.M.) blade only, listed in this manual. "Use of parts which do not meet the original equipment specifications may lead to improper performance and compromise safety!"
- Mower blades are sharp and can cut. Wrap the blade(s) or wear gloves, and use extra caution when servicing them.
- Keep all nuts, bolts, and screws tight to be sure the equipment is in safe working condition.
- Never tamper with safety devices. Check their proper operation regularly.
- After striking a foreign object, stop the engine, disconnect the spark plug wire and ground against the engine. Thoroughly inspect the mower for any damage. Repair the damage before starting and operating the mower.
- Grass catcher components, discharge cover, and trail shield are subject to wear and damage which could expose moving parts or allow objects to be thrown. For safety protection, frequently check components and replace immediately with original equipment manufacturer's (O.E.M.) parts only, listed in this manual. "Use of parts which do not meet the original equipment specifications may lead to improper performance and compromise safety!"
- Do not change the engine governor setting or overspeed the engine. The governor controls the maximum safe operating speed of the engine.
- Maintain or replace safety and instruction labels, as necessary.
- Observe proper disposal laws and regulations. Improper disposal of fluids and materials can harm the environment.

SI-102
1.17.02

OWNER'S
MANUAL



SAFETY LABEL



WARNING - Your Responsibility:

Restrict the use of this power machine to persons who read, understand and follow the warnings and instructions in this manual and on the machine.

SLOPE GAUGE

(Keep this sheet in a safe place for future reference.)

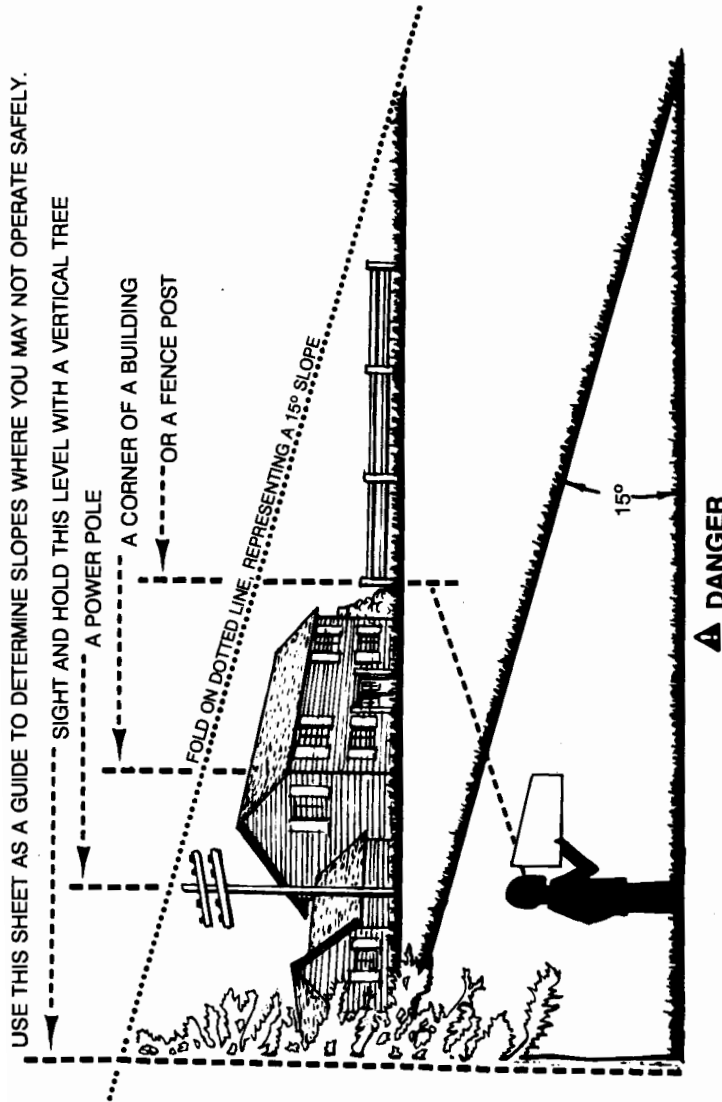

Do not mow on inclines with a slope in excess of 15 degrees (a rise of approximately 2½ feet every 10 feet). A riding mower could overturn and cause serious injury. If operating a walk-behind mower on such a slope, it is extremely difficult to maintain your footing and you could slip, resulting in serious injury.

Operate RIDING mowers up and down slopes, never across the face of slopes.

Operate WALK-BEHIND mowers across the face of slopes, never up and down slopes.

SET-UP INSTRUCTIONS

This unit is shipped **WITHOUT GASOLINE or OIL**. After assembly, service engine with gasoline and oil as instructed in the separate engine manual packed with your unit.

NOTE: Reference to right or left hand side of the mower is observed from the operating position.

HOW TO SET-UP YOUR LAWN MOWER

- Disconnect the spark plug wire and move it away from spark plug as instructed in the separate engine manual packed with your unit.
- Remove the carton inserts (if any). Remove the loose parts which are in the carton, lift the mower from the carton, or cut the corners of the carton and roll the mower out.
- Pull up and back on the upper handle to raise the handle into the operating position. See Figure 1. Make certain the lower handle is seated securely into the handle mounting brackets. Tighten the wing nuts on each side of the handle.
- Remove the hairpin clips from the outer hole in the weld pins on the handle mounting brackets. Place the hairpin clips in the inner hole.
- Place one carriage bolt (found in the hardware pack included with your unit) in the upper hole of the right handle mounting bracket from the inside outward. Secure with one plastic wing nuts. Repeat process on other side. See Figure 2.

NOTE: Make certain the drive cable is routed around the outside and above the lower handle so it does not interfere with attaching the grass bag.

- The rope guide (pigs tail) is part of the grass catcher support rod attached to the lower handle. See Figure 3. With the **spark plug wire disconnected and grounded as instructed in the separate engine manual**, depress the starter control button fully with your thumb. See Figure 4.
- Hold the blade control handle against the upper handle, and pull the starter rope out of the engine slowly until it extends past the rope guide (pigs tail).
- Guide the starter rope around the rope guide (pig tail) until the rope is securely in the center.
- Make certain all nuts and bolts are tightened securely.

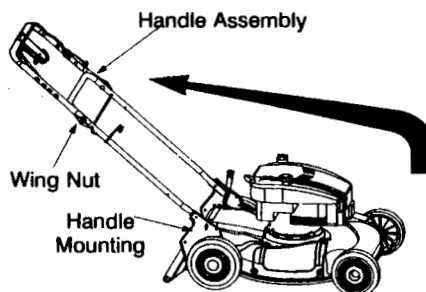
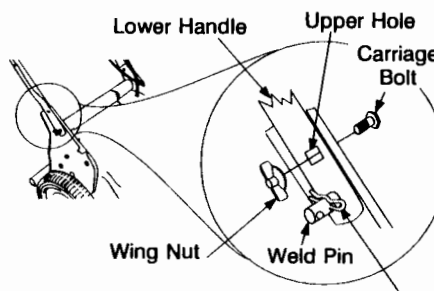

Figure 1



Place the hairpin clips in the inner hole.

Figure 2

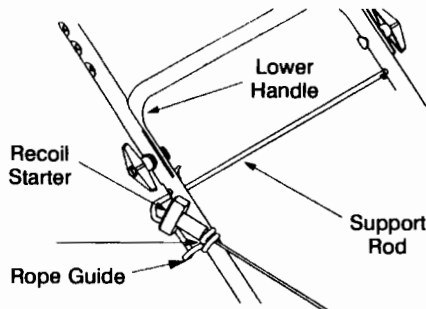

Figure 3

CONTROLS

WARNING: Be familiar with all controls and their proper operation. Know how to stop the machine and disengage them quickly.

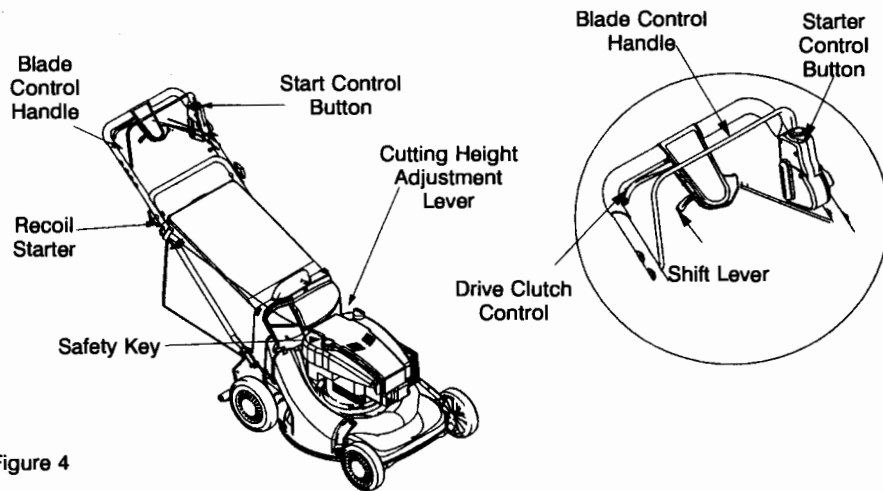

Figure 4

Safety Key

The safety key is located on the engine. The safety key is a safety device used to activate and deactivate the self starter system. The self starter system will not work without the key in its proper position. See engine manual for further information pertaining to the safety key.



NOTE: The safety key must be in the run position to start the mower for both systems, either the self starter or recoil starter.

Blade Control Handle

! WARNING: The blade control handle is a safety device. Never attempt to bypass its operations. Doing so, may result in personal injury through contact with the rotating blade. The blade rotates whenever the engine is running and when the self starter is de-energized.

The blade control handle is located on the upper handle of the mower. See Figure 4. The blade control handle and starter control button must be depressed in order to operate the unit. Release the blade control handle to stop the engine and blade and to energize the self starter.

Recoil Starter

The recoil starter handle is attached to the upper handle. See Figure 4. The recoil

starter is used to start the engine when the self starter is in the de-energized mode.

Start Control Button

The start control button is located on the upper left side of the handle. See Figure 4. The start control button must be depressed fully while pulling the blade control handle toward upper handle for the engine to start. The starter control button will automatically return to the off/ up position once the blade control handle is released.



NOTE: The starter button must be depressed to start the engine with either the self starter or recoil starting system.

Drive Clutch Control

Squeezing the drive clutch control engages the drive system. Releasing the clutch control disengages the drive system. Release the clutch control to slow down when negotiating an obstacle, making a turn or stopping.

Shift Lever

The shift lever is located on the drive clutch control housing on the upper handle. See figure 4. This lever is used to select the forward speed of the mower. When changing your speed selection, release the drive clutch control.

IMPORTANT: Only move the shift lever when the engine is running. Changing the shift lever setting with the engine off can cause damage to the mower.

CUTTING HEIGHT ADJUSTMENT LEVER (Models: 959 & 979)

The height adjuster determines the cutting height of the mower. The adjuster is located on the left side of the deck. To adjust the cutting height, pull the lever out and away from the mower and then move it forward or back to select a new cutting height. See figure 5.

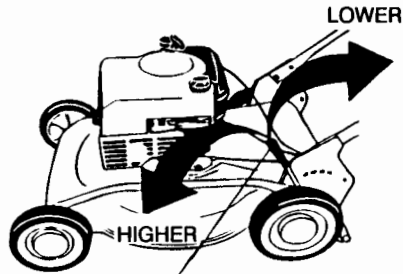

Cutting Height Adjustment Lever

Figure 5

CUTTING HEIGHT ADJUSTMENT LEVER (Model: 999)

The **rear wheel** height adjuster determines the cutting height of the mower. The adjuster is located on the left side of the deck. To adjust the cutting height, pull the lever out and away from the mower and then move it forward or back to select a new cutting height. See figure 5.

The **front wheel** cutting height is determined by the selection of one of six positions in each caster assembly. See figure 6.

To adjust, remove the wing nut from the axle bolt. Slide the axle bolt and spring washer from the assembly and select a cutting height. With the spring washer on the axle bolt reinsert in the square hole desired, through the wheel assembly and secure with the wing nut previously removed.

IMPORTANT: All wheels must be placed in the same relative position.

NOTE: For rough or uneven lawns, move the height adjustment lever to a higher position. This will help stop scalping.

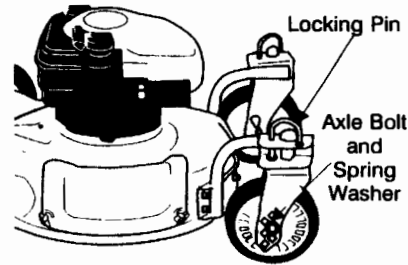

Figure 6

CASTER LOCK

WARNING: When operating mower on hills, front wheels should be locked in the straight ahead position,

The casters can be locked in a straight ahead position or can be left to swivel freely. Lift and place the lock pins in the larger holes for locked, straight ahead operation, place pins in smaller holes to allow casters to rotate freely.

OPERATION

WARNING: Read, understand, and follow all instructions and warnings on the machine and in this manual before operating.

Keep hands and feet away from the discharge area on and from under the cutting deck.

The operation of any lawn mower can result in foreign objects being thrown into the eyes, which can result in severe eye damage. Always wear safety glasses or eye shields.

NOTE: For best results raise the cutting position until it is determined which height is best for your lawn. See Cutting Height Adjustment section.

BEFORE STARTING

Service the engine with gasoline and oil as instructed in the separate engine manual packed in your mower. Read instructions carefully.

WARNING: Never fill fuel tank indoors, with engine running or until the engine has been allowed to cool for at least two minutes after running.

TO START ENGINE AND ENGAGE BLADE

- Attach spark plug wire to spark plug. If unit is equipped with a rubber boot over the end of the spark plug wire, make certain the metal loop on the end of the spark plug wire (inside the rubber boot) is fastened securely over the metal tip on the spark plug. See figure 7.

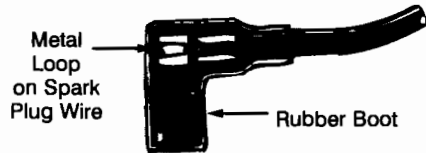

Figure 7

IMPORTANT: Move the shift lever **ONLY** when the engine is running. Shifting the speeds with the engine off can cause damage to the unit.

NEUTRAL TEST FOR ALL MODELS:



- Before each use, check for proper drive clutch operation by performing the following before starting the engine:

With the drive clutch control released, push mower forward. It should move freely.

If it does not and the rear wheels tend to lock up, the clutch may not be releasing completely. Do not start the engine until corrections have been made. Check the control cable for severe bend, kinks and binding, or grass build-up in the pulley groove.

First Time Starting Engine

NOTE: Use recoil starter rope to start engine for the very first time. The mower is shipped with the safety key in the locked and de-energized mode, follow instructions as follows.

1. Place lawn mower on a level surface outdoors.
2. Remove clear plastic packaging under fuel cap.
3. Open shut off valve (if equipped) 1/4 turn. 
4. Turn safety key 1/4 turn clockwise to RUN position. 
5. If your unit is equipped with a primer, prime engine as instructed in the separate engine manual packed with your unit. 
6. While standing in the operating position, depress the starter con-



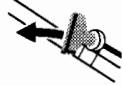

rol button fully with the thumb of your right hand.

7. Using your left hand, pull the control handle all the way toward the upper handle. See Figure 10. 
8. Release the button. 
9. Grasp the recoil rope starter handle with your right hand and slowly pull towards you until you feel a slight resistance, then pull firmly until your arm is fully extended.
10. If engine does not start by the second pull, repeat steps 5, 6, 7,8 and 9.

Second Time Starting Engine

NOTE: Follow these instructions if the self starter is already in the energized mode.

-  **WARNING: NEVER assume starter is in the de-energized mode, even if the key is in the locked position and/or removed from the engine. ALWAYS de-energize starter prior to performing any maintenance or service to the engine and/or mower. Follow instructions on the engine and/or machine to de-energize starter.**

1. Check oil and fuel level and add if necessary.
2. Open shut off valve (if equipped) 1/4 turn. 
3. Turn safety key 1/4 turn clockwise to RUN position. 
4. Firmly push primer bulb 3 times (For a cold engine only!). 
5. While standing at upper handle, depress and hold the starter control button with the thumb of your right hand. 
6. Using your left hand, pull the blade control handle all the way toward the upper handle. Starter will de-energize and engine will start. 

NOTE: If engine does not start, release the blade control handle and follow steps 5, 6, 7,8 and 9 in the "First Time Starting Engine" instructions.)

NOTE: If any problems are encountered, refer to the Trouble Shooting Guide for helpful information.

To Stop Engine And Blade

1. Release safety blade control handle (the start control button will automatically return to the off/up position), engine and blade will stop within a few seconds.

NOTE: Engine may stop with a ratcheting sound. This sound is the self starter being reactivated/energized for the next start.

2. Turn safety key 1/4 turn counterclockwise to LOCK position. Remove key and store in a safe place.
3. Disconnect and ground the spark plug wire as instructed in the separate engine manual to prevent accidental starting while equipment is unattended.

 **WARNING:** The blade will continue to rotate for three seconds after the blade control lever is released.

To De-Energize Self Starter

- Remove spark plug wire from spark plug.
- Turn safety key to RUN position (1/4 turn clockwise).
- While standing in the operating position, depress the starter control button fully with the thumb of your right hand.
- Using your left hand, pull the control handle all the way toward the upper handle.
- Release button.

NOTE: Engine will crank over upon actuating equipment starting controls, but will not spark if spark plug wire was removed from spark plug as described above. Once engine has stopped cranking, self starter is de-energized.

 **WARNING: Self Starting System:** If these instructions are not followed, amputation or severe laceration can result.

- ALWAYS disconnect spark plug, de-energize starter, lock and remove safety key BEFORE performing ANY service to the engine or mower.
- DO NOT attempt any maintenance or repairs to the self starter.
- NEVER assume starter is de-energized, even if key is in LOCK AND REMOVE position and/or removed from engine.
- BEFORE removing grass or other debris from under mower deck; BEFORE changing oil, air filter or spark plug; BEFORE removing blade for servicing; BEFORE performing any other service to engine or mower; BE-

FORE transporting mower-ALWAYS DE-ENERGIZE SELF STARTER.

- ALWAYS lock and remove safety key and store in a safe place until next use. The safety key is designed and intended to be removed from engine when not in use. Removing key will prevent unsupervised or unexpected starting of mower by children or unsuspecting adults. The safety key must be in the locked position before it can be removed.

USING YOUR MULCHING MOWER

Be sure that lawn is clear of stones, sticks, wire, or other objects which could damage lawn mower or engine. Such objects could be accidentally thrown by the mower in any direction and cause serious personal injury to the operator and others.

For the best results, do not cut wet grass because it tends to stick to the underside of the mower, preventing proper mulching of grass clippings. In addition, wet grass could cause you to slip and fall. New grass, thick grass or wet grass may require a narrower cut.

For best results, cut off one-third or less of the total length of the grass. Lawn should be cut in the fall as long as there is growth.

The mower is designed to be operated at full throttle to give you the best cut and do the most effective job of mulching.

 **WARNING:** If you strike a foreign object, stop the engine. Remove wire from spark plug, thoroughly inspect the mower for any damage, and repair the damage before restarting and operating the mower. Extensive vibration of the mower during operation is an indication of damage. The unit should be promptly inspected and repaired.

BAGGING GRASS CLIPPINGS

This mower can bag grass clippings. Follow steps 1 through 3 to ready the mower for bagging.

1. Remove wing nuts holding mulching baffle (see figure 8) or side discharge chute (see figure 12) in place. Then remove baffle or discharge chute.
2. Replace with bagging adapter (see figure 9). Attach using wing nuts. Be sure that inner lip of attachment goes under the edge of the deck.
3. Lift flap and slide bag onto adapter. See Figure 10.

EMPTYING YOUR GRASS BAG

Lift grassbag from the bagging adapter using the lower handle. While holding the lower handle lift up the rear section of the grassbag. The bag will open and the grass clippings will fall out. See figure 11. When replacing your grassbag be sure the top of the bag rests on the wire support between the handles.

SIDE DISCHARGE GRASS CLIPPINGS

This mower can also side discharge grass clippings. Follow steps 1 and 2 to ready this mower for side discharge operation.

1. Remove mulching baffle or grass bag adapter. See figure 8.
2. Attach discharge chute with wing nuts. See figure 12.

ADJUSTMENT



WARNING: Be sure to disconnect the spark plug wire and DE-ENERGIZE starter before performing any adjustments or repairs. DO NOT attempt any maintenance or service to the engine and/or mower equipped with the safety key in the unlocked and/or energized mode.



WARNING: NEVER assume starter is de-energized, even if the key is in the locked position and/or removed from the engine. ALWAYS de-energize self starter prior to performing any maintenance or service to the engine and/or mower. Follow instructions on the engine and/or machine to de-energize starter

MODELS WITH SINGLE LEVER HEIGHT ADJUSTERS:

Refer to "Controls Section" and figure 5.

HANDLE HEIGHT ADJUSTMENT

Your mower is shipped with the handle in the higher height position. To lower the handle height, proceed as follows.

1. Remove the starter rope and the rope guide.
2. Remove the upper handle by removing the handle knobs and carriage bolts. Lay the upper handle out of the way, being careful not to bend or kink the cables.
3. Remove the hairpin clips from the weld pins on the handle brackets. Press out on the legs of the lower handle. Remove lower handle from the mower.

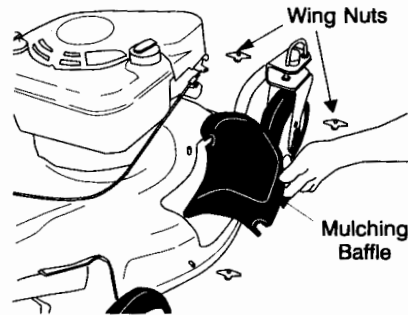

Figure 8

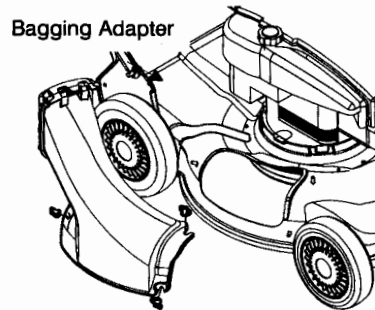

Figure 9

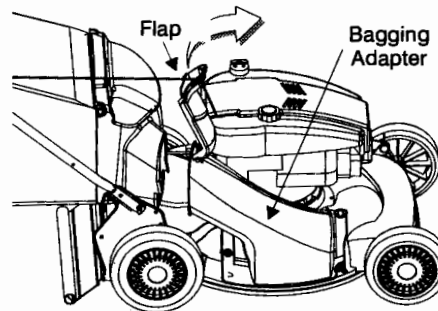

Figure 10



Figure 11

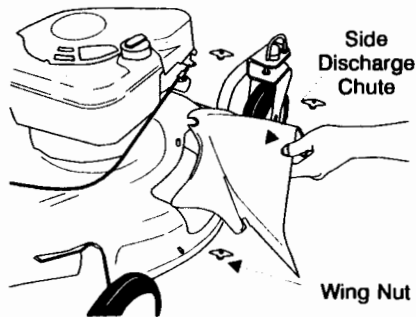

Figure 12

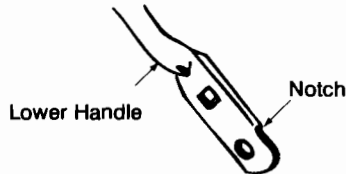

Figure 13

4. Turn the lower handle around so the notch on the bottom of the lower handle is facing forward as shown in Figure 13. Reassemble, placing the bottom holes in the handle over the weld pins in the handle mounting bracket.
5. Reassemble the upper handle to the lower handle.
6. Place the hairpin clips in the inner holes of the weld pins and secure with carriage bolts and wing nuts as instructed in the "Set-Up" section of this manual.
7. Attach the starter rope and rope guide as instructed in the "Set-Up" section of this manual.

DRIVE CLUTCH CONTROL ADJUSTMENT

Use the adjustment wheel located on the underside of the clutch control housing to tighten the drive belt if mower does not self-propel with the drive clutch control engaged, or if drive belt is slipping (unit hesitates while engine maintains the same speed). See figure 15.

In addition, the adjustment wheel may also be used to determine the position in which the drive clutch control is engaged. If it is more comfortable to have the drive engaged with the lever further away from the handle, tighten the drive belt.

Make certain to retest the unit for neutral as instructed in the operation Section. Move the adjustment wheel in the opposite direction to loosen the drive belt if necessary.

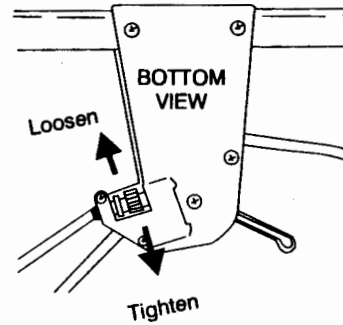

Figure 15

SIX SPEED SHIFT CABLE ADJUSTMENT

Periodic adjustment of the six speed shift cable may be required due to normal stretch and wear on the cable. Adjustment is needed if all six speeds cannot be obtained.

The adjustable cable bracket is located on the left side of the mower, beside the engine. To adjust, loosen the hex nut which secures the adjustable cable bracket. See figure 16. Pull backward on the bracket (toward the rear of the mower). Retighten the hex nut. Test the speeds on the mower (engine must be running).

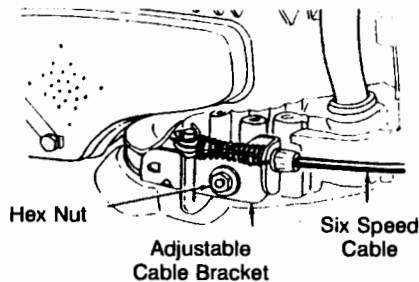

Figure 16

CARBURETOR ADJUSTMENT

Refer to the separate engine manual packed with your mower for carburetor adjustment information.

LUBRICATION

WHEELS - Lubricate the ball bearings in each wheel at least once a season with a light oil. Also, if the wheels are removed for any reason, lubricate the surface of the axle bolt and the inner surface of the wheel with light oil. Engine oil may also be used.

ENGINE - Follow engine manual for lubrication instructions.

BLADE CONTROL - Lubricate the pivot points on the blade control handle and the brake cable at least once a season with light oil. The blade control must operate freely in both directions.

TRANSMISSION - The transmission is pre-lubricated and sealed at the factory. It does not require checking. If disassembled for any reason, fill with 2 ounces of Benelyn grease, part number 737-0300.

MAINTENANCE



WARNING: Be sure to disconnect the spark plug wire and DE-ENERGIZE starter before performing any adjustments or repairs. DO NOT attempt any maintenance or service to the engine and/or mower equipped with the safety key in the unlocked and/or energized mode.



WARNING: NEVER assume starter is de-energized, even if the key is in the locked position and/or removed from the engine. ALWAYS de-energize self starter prior to performing any maintenance or service to the engine and/or mower. Follow instructions on the engine and/or machine to de-energize starter

For best results your blade should be sharp. The blade may be resharpened by removing it and either grinding or filing the cutting edge keeping as close to the original bevel as possible.

Improper blade balance will result in excessive vibration causing eventual damage to the engine and mower. Be sure to carefully balance blade after sharpening.

After prolonged use, especially in sandy soil conditions, the blade will become worn and lose some of the original shape. Cutting efficiency will be reduced and the blade should be replaced. Replace with an approved factory replacement blade only. Possible damage resulting from blade unbalance condition is not the responsibility of the manufacturer.

ENGINE

Refer to the separate engine manual for engine maintenance instructions.

Maintain engine oil as instructed in the separate engine manual packed with your unit. Read and follow instructions carefully.

Service air cleaner as per separate engine manual under normal conditions. Clean every few hours under extremely dusty conditions. Poor engine performance and flooding usually indicates that the air cleaner should be serviced. To service the air cleaner, refer to the separate engine manual packed with your unit.

The spark plug should be cleaned and the gap reset once a season. Spark plug replacement is recommended at the start of each mowing season; check engine manual for correct plug type and gap specifications.

NOTE: This spark ignition system meets all requirements of the Canadian Interference-Causing Equipment Regulations.

Clean the engine regularly with a cloth or brush. Keep the cooling system (blower housing area) clean to permit proper air circulation which is essential to engine performance and life. Be certain to remove all grass, dirt and combustible debris from muffler area.

DECK

The underside of the mower deck should be cleaned after each use to prevent a buildup of grass clippings, leaves, dirt or other matter. If this debris is allowed to accumulate, it will invite rust and corrosion, and may prevent proper mulching.

The deck may be cleaned by tilting the mower and scraping clean with a suitable tool (make certain the spark plug wire is disconnected).

CUTTING BLADE



WARNING: Be sure to disconnect and ground the spark plug wire and remove ignition key before working on the cutting blade to prevent accidental engine starting. Protect hands by using heavy gloves or a rag to grasp the cutting blades.

Tip mower as specified in separate engine manual. If it is not specified tip with carburetor up.

Remove the bolt and blade support which holds the blade and adapter to the engine crankshaft. Remove the blade and adapter from the crankshaft.



WARNING: Periodically inspect the blade adapter for cracks, especially if you strike a foreign object. Replace when necessary.

For best results your blade should be sharp. The blade may be resharpened by removing it and either grinding or filing the cutting edge

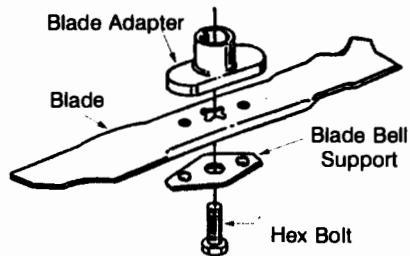

Figure 17

keeping as close to the original bevel as possible. It is extremely important that each cutting edge receives an equal amount of grinding to prevent an unbalanced blade. Improper blade balance will result in excessive vibration causing eventual damage to the engine and mower. Be sure to carefully balance blade after sharpening. The blade can be tested for balance by balancing it on a round shaft screwdriver. Remove metal from the heavy side until it balances evenly.

Before reassembling the blade and the blade adapter to the unit, lubricate the engine crankshaft and the inner surface of the blade adapter with light oil. Install the blade adapter on the crankshaft with the "star" away from the engine. Refer to figure 17. Place the blade with the side marked bottom (or with part number) facing away from the adapter. Align the blade bell support over the blade with the tabs in the holes of the blade and insert the hex bolt. Tighten the hex bolt to the torque listed below:

Blade Mounting Torque

Center Bolt 450 in. lb. min., 600 in.lb. max.

To insure safe operation of your unit, ALL nuts and bolts must be checked periodically for correct tightness.

CAUTION: Cutting grass in sandy soil conditions causes abrasive wear to the blades.

After prolonged use, especially in sandy soil conditions, the blade will become worn and lose some of the original shape. Cutting efficiency will be reduced and the blade should be replaced. Replace with an approved factory replacement blade only. Possible damage resulting from blade unbalance condition is not the responsibility of the manufacturer.

BELT REMOVAL AND REPLACEMENT

1. Disconnect the spark plug wire and ground it against the engine.

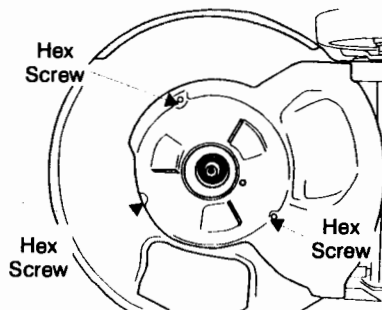

Figure 18

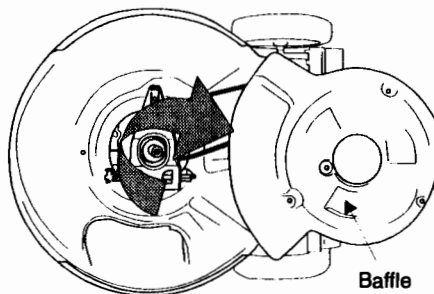

Figure 19

2. Drain the fuel tank or place a piece of plastic beneath the cap to prevent gasoline leakage.
3. Tip the mower on its side. Block securely.
4. Remove the blade and blade adapter as described in the "Blade Replacement" section.
5. Move rear height adjuster to the highest position.
6. Using a 3/8" socket remove three hex screws holding the baffle to the deck. See figure 18.
7. Pivot baffle towards the rear of the mower. See figure 19.
8. Remove the hex bolt holding the transmission to the mower housing. See figure 20.
9. Tilt the transmission forward and loosen the idler pulley bolt and locknut 1/2 turn using two 7/16" wrenches. See Figure 20.
10. Using a pair of pliers, pull back and rotate belt keeper bracket from the slot on idler pulley.
11. Slide the belt out from between the belt keeper bracket and the idler pulley. See figure 21.
12. Squeeze the belt together and push belt forward. Press the control arm inward to-

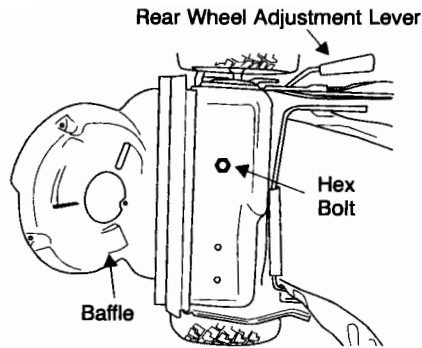

Figure 20

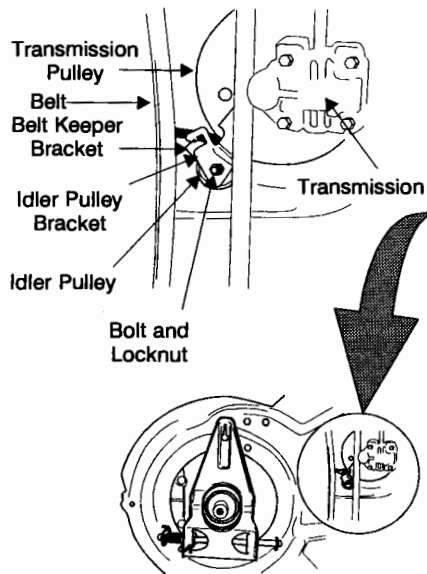

Figure 21

Mower is shown tipped on engine for clarity. Remember, only tip mower back on its handle with the spark plug facing up.

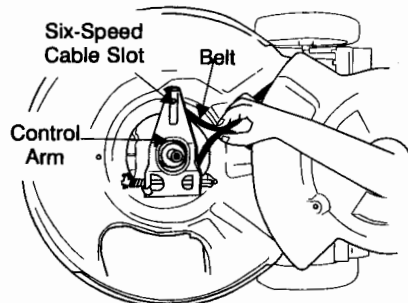

Figure 22

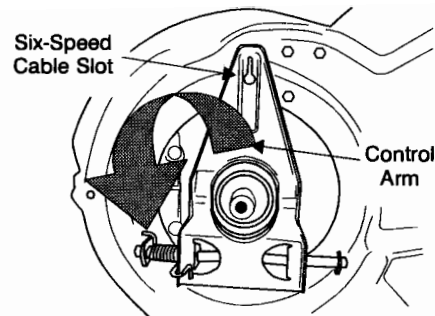

Figure 23

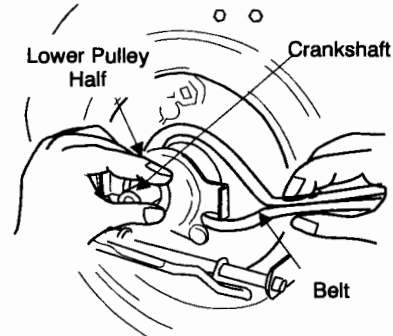

Figure 24

- wards the deck and remove the six speed cable from the slot. See figure 22.
13. Pivot the control arm down away from the pulley and belt. See figure 23.
 14. Lift off the lower pulley assembly and remove the old belt from around the crankshaft. See figure 24.
 15. Place the new belt over the transmission pulley. Start the belt in pulley groove and rotate pulley until belt is seated in transmission pulley. See figure 24.
 16. Place belt between idler pulley and the belt keeper bracket.
 17. Using pliers, rotate the belt keeper bracket so that it snaps into slot on the idler bracket.
 18. Tighten the idler pulley bolt and locknut $\frac{1}{2}$ turn using two $\frac{7}{16}$ " wrenches. See figure 21.
 19. Place belt between the two pulley halves on the crankshaft. Make sure to route the belt inside the belt guard pin. See figure 25.

IMPORTANT: For proper assembly, it is essential to keep the assembly positioned as shown in figure 25.

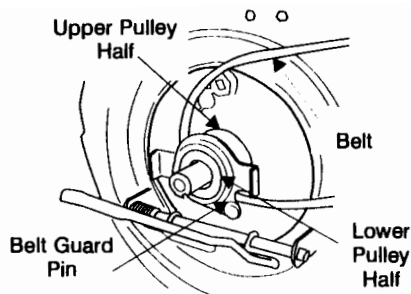

Figure 25

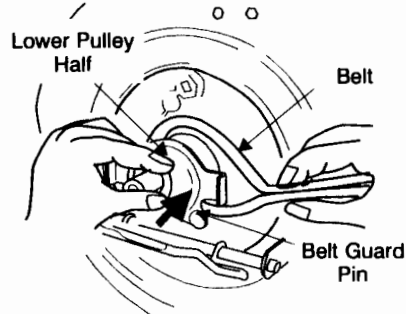

Figure 26

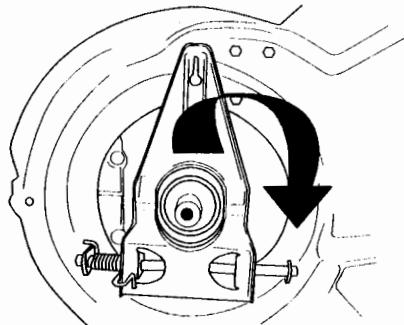

Figure 27

20. Pinch belt together so that it is not in the pulley groove, and the lower pulley can be pushed towards the engine. See figure 26.
21. Pivot the control arm back to its original position and reinstall the six-speed cable into the slot.
22. Check and make sure the belt is routed inside the pulley halves and the belt guard pin. See figure 27.
23. Reinstall the bolt securing transmission to rear mower housing.
24. Pivot the baffle back to its original position and secure with three hex screws earlier removed. You will need a 3/8" socket for these screws.

25. Lightly lubricate the crankshaft and reinstall blade and blade adapter as described in the "Blade Replacement" section.
26. Tip the mower back on its wheels.
27. Make certain to retest the unit for neutral as instructed in the Operation Section.

OFF SEASON STORAGE INSTRUCTIONS

WARNING: Be sure to disconnect the spark plug wire and DE-ENERGIZE starter before performing any adjustments or repairs. DO NOT attempt any maintenance or service to the engine and/or mower equipped with the safety key in the unlocked and/or energized mode.

WARNING: NEVER assume starter is de-energized, even if the key is in the locked position and/or removed from the engine. ALWAYS de-energize self starter prior to performing any maintenance or service to the engine and/or mower. Follow instructions on the engine and/or machine to de-energize starter

The following steps should be taken to prepare lawn mower for storage.

1. Clean and lubricate mower thoroughly as described in the lubrication instructions.
2. Refer to engine manual for correct engine storage instructions.
3. Coat mower's cutting blade with chassis grease to prevent rusting.
4. Store mower in a dry, clean area.

NOTE: When storing any type of power equipment in an unventilated or metal storage shed, care should be taken to rust-proof the equipment. Using a light oil or silicone, coat the equipment, especially cables and all moving parts.

NOTE: Be careful not to bend or kink cables.

NOTE: If the starter rope becomes disconnected from rope guide on handle, disconnect and ground the spark plug wire. Depress the bail and pull the starter rope out from engine slowly. Slip the starter rope into the rope guide bolt on handle.

Free Manuals Download Website

<http://myh66.com>

<http://usermanuals.us>

<http://www.somanuals.com>

<http://www.4manuals.cc>

<http://www.manual-lib.com>

<http://www.404manual.com>

<http://www.luxmanual.com>

<http://aubethermostatmanual.com>

Golf course search by state

<http://golfingnear.com>

Email search by domain

<http://emailbydomain.com>

Auto manuals search

<http://auto.somanuals.com>

TV manuals search

<http://tv.somanuals.com>