



Owner/Operator Manual

ECONO-HORSE™ PONY® & JUNIOR® Model Tillers

- Safety
- Assembly
- Controls
- Operation
- Maintenance

Models

15006

15008

15009

12174

NEW SKU
(ECONO)



Dear Owner,

You now own one of the finest rear-tine rototillers available. Your new ECONO-HORSE® Model, PONY® Model or JUNIOR® Model tiller allows you to till and cultivate your garden with ease, and accomplish dozens of other property management projects as well. Your tiller is famous for its ruggedness, performance and high-quality engineering. We know you'll enjoy using it.

Please carefully read this Manual. It tells you how to safely and easily assemble, operate and maintain your machine. *Be sure that you and any other operators carefully follow the recommended safety practices at all times. Failure to do so could result in personal injury or property damage.*

Of course, if you should ever have any problems or questions, or for a replacement copy of this Manual, please contact your local authorized service dealer or call us Toll-Free. Our telephone numbers and mailing addresses are listed on Page 3 and the back cover of this Owner/Operator Manual.

We want to be sure that you are completely satisfied at all times.

*Your Friends
at Troy-Bilt*

This machine meets voluntary safety standard B71.8 – 1996, which is sponsored by the Outdoor Power Equipment Institute, Inc., and is published by the American National Standards Institute.



This is a safety alert symbol. It is used in this Owner/Operator Manual to alert you to potential hazards.

Whenever you see this symbol, read and obey the safety message that follows it. Failure to obey the safety message could result in personal injury or property damage.

Be Sure To Return Your Warranty Registration Card

Be sure to fill out and mail your Warranty Registration Card, which is located in your literature package. The information contained on this card will register your machine with us and entitle you to warranty coverage.

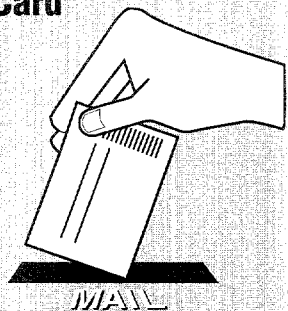

WARNING:

The engine exhaust from this product contains chemicals known to the State of California to cause cancer, birth defects, or other reproductive harm.

Table of Contents

Owner's Record

Please write the Model and Serial numbers of your machine in the spaces provided. You can find the location of these numbers by referring to the graphic below.

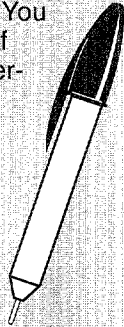

Model Number:

Serial Number:

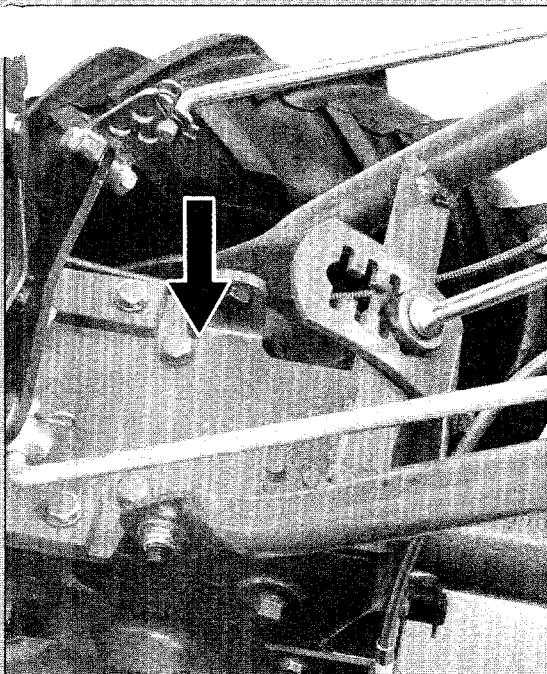

Model and Serial Number location

SECTION 1: SAFETY INSTRUCTIONS	4
Safety Alert Symbol.....	4
Training	4
Preparation	4
Operation	4
Maintenance and Storage.....	6
Decals	6
SECTION 2: EASY ASSEMBLY	7
SECTION 3: TILLER AND ENGINE CONTROLS	18
Tiller Controls.....	18
Engine Controls.....	22
SECTION 4: OPERATION OF TILLER.....	24
Before Starting	25
To Begin Tilling.....	25
Turning Around	25
Stopping the Tiller and Engine	25
Changing Speeds (Econo-Horse only).....	26
Tilling in the Garden	27
Guiding your Tiller	27
Tilling Depths	27
Tilling Patterns.....	28
Choosing Wheel and Tine Speeds.....	29
Avoid Making Footprints	29
Clearing Debris from the Tine Area	29
Power Composting	30
Using Reverse to Turn in Tight Areas.....	30
Tilling Near Obstacles	30
Tilling Up and Down Slopes.....	31
Tilling Across Slopes Using Terraces.....	31
Tilling Across Slopes Without Terraces.....	32
Loading and Unloading the Tiller	32
SECTION 5: TILLER AND ENGINE MAINTENANCE.....	33
Lubrication.....	33
Check for Oil Leaks	34
Tightening Nuts and Bolts	34
Checking/Adding/Changing Transmission Gear Oil	34
Checking Engine Oil Level	35
Changing Engine Oil.....	36
Air Cleaner Service.....	36
Spark Plug Maintenance	37
Ignition System Maintenance.....	37
Air Cooling System Maintenance	37
Bolo Tines	37
Checking Tension on the Drive Belts	38
Adjusting Forward Drive Belt Tension.....	39
Removing and Installing Forward Drive Belt	41
Removing and Installing Reverse Drive Belt.....	42
Adjusting Reverse Drive Belt Tension.....	43
Wheel Gear Cable Adjustment.....	43
Engine Throttle Cable Adjustment	44
Off-Season Storage.....	44
Troubleshoot Electric Start System	45
Battery Care and Maintenance.....	47
Carburetor Adjustment.....	47
Specifications.....	48
Recommended Maintenance Intervals	49
TROUBLESHOOTING	50-51
INDEX	52

 **CAUTION****TO AVOID SERIOUS INJURY:**

- **READ THE OWNER / OPERATOR MANUAL.**
- **KNOW LOCATIONS AND FUNCTIONS OF ALL CONTROLS.**
- **KEEP ALL SAFETY DEVICES AND SHIELDS IN PLACE AND WORKING.**
- **NEVER ALLOW CHILDREN OR UNINSTRUCTED ADULTS TO OPERATE TILLER.**
- **SHUT OFF ENGINE AND DISCONNECT SPARK PLUG WIRE BEFORE MANUALLY UN-CLOGGING TINES OR MAKING REPAIRS.**
- **KEEP BYSTANDERS AWAY FROM MACHINE.**
- **KEEP AWAY FROM ROTATING PARTS.**
- **USE EXTREME CAUTION WHEN REVERSING OR PULLING THE MACHINE TOWARDS YOU.**

 **WARNING**

The engine exhaust from this product contains chemicals known to the State of California to cause cancer, birth defects, or other reproductive harm.

**WARNING TO ALL CALIFORNIA AND OTHER POWER EQUIPMENT OPERATORS**

Under California law, and under the laws of several other states, you are not permitted to operate an internal combustion engine using hydrocarbon fuels on any forest covered, brush covered, or grass covered land, or on land covered with grain, hay, or other flammable agricultural crop, without an engine spark arrester in continuous effective working order.

The engine on your power equipment, like most outdoor power equipment, is an internal combustion engine that burns gasoline, a hydrocarbon fuel. Therefore, your power equipment must be equipped with a spark arrester muffler in continuous effective working order. The spark arrester must be attached to the engine exhaust system in such a manner that flames or heat from the system will not ignite flammable material. Contact your authorized engine dealer for information about obtaining a spark arrester. Failure of the owner / operator of the equipment to comply with this regulation is a misdemeanor under California law, and may also be a violation of other state and/or federal regulations, laws, ordinances, or codes. Contact your local fire marshal or forest service for specific information about what regulations apply in your area.

ENGINE SERVICE

If your tiller engine ever needs service or repair, contact your nearest Briggs & Stratton or Tecumseh Service Dealer.

To find the nearest Service Dealer, look in the Yellow Pages of your phone book under "Engines-Gasoline", or "Gasoline Engines."

If you have problems getting engine service or parts locally, let us know so we can provide you with the name of the nearest Service Dealer.

QUESTIONS OR PROBLEMS?

1. Check this Owner/Operator Manual:

The answer to your question or problem may be in this Manual. Refer to the index at the back of this Manual to find the listing that concerns your problem. Turn to that page and read the information provided.

2. Call or write to us:

If you can't find the answer to your question or problem in this Manual, please call us or write to us. One of our helpful, friendly tiller experts will gladly help you. Be sure to include your tiller model name and the serial number of your tiller.

3. If you need a part:

Call or write to our Parts Department (see the Toll-Free telephone number below). Please have your tiller model name and serial number at hand. Use the Parts Catalog to find the part number and quantity of the part you need. Remember that you can purchase many of the common hardware items at your local hardware store as well as ordering them from us.

For Fastest Service, Use The Numbers Below

In the U.S.A.:

Customer Service	1-800-437-8686
Technical Service	1-800-520-5520
Parts Orders	1-800-648-6776

Outside the U.S.A. and Canada:

Customer Service	(518) 391-7007
Technical Service	(518) 391-7008
Parts Service	(518) 391-7006

If you would rather write, our mailing address is:

Garden Way Incorporated
1 Garden Way
Troy, New York 12180

IMPORTANT!

If you notice any freight damage or missing parts, either at the time of delivery or later during assembly, make sure that you put it in writing, within 15 days, and send your letter to the shipper to confirm that you intend to file a claim. Tell the driver, or inform the truck terminal, that you intend to file a written claim. They will advise you as to how to proceed. However, if you have any problems with this procedure, please call us so that we can help you get satisfaction.

Section 1: Safety Instructions

Your TROY-BILT Model Tiller has been designed with many safety features. However, as with any other piece of powered equipment, the operator must follow safe operating practices at all times. Failure to do so could result in personal injury or damage to the equipment or property.

Before assembling, operating or servicing the tiller or its engine, carefully read and follow all of the safety instructions found in this Owner / Operator Manual, in the separate Engine Owner's Manual, and in any other literature you may receive. If you ever have any questions, please call us at one of the numbers listed on page 3 of this manual.

If you ever lend your tiller to someone, make sure that he or she reads, understands, and follows the Safety Instructions. Always use your tiller carefully and keep safety in mind.



SAFETY ALERT SYMBOL. This symbol is used to alert you to important safety messages in this Manual and on decals which are on your tiller regarding potential hazards. When you see this symbol, carefully read and follow its safety message. Failure to do so can result in personal injury or property damage.

TRAINING

1. Carefully read this Owner/Operator Manual, the separate Engine Owner's Manual, and any other literature you may receive. Be thoroughly familiar with the controls and the proper use of the tiller and its engine. Know how to stop the unit and disengage the controls quickly.
2. Never allow children to operate the tiller. Let adults operate the tiller only if instructed properly.
3. Keep the area of operation clear of all persons (particularly children) and pets.
4. Keep in mind that the operator or user is responsible for accidents or hazards occurring to other people, their property, and themselves.

PREPARATION

1. Thoroughly inspect the area where the tiller is to be used and remove all foreign objects.
2. Be sure all control levers are released and the ECONO-HORSE or PONY Model Wheel Gear Lever is in "ENGAGE" before starting the engine. On the JUNIOR Model, which does not have a Wheel Gear Lever, be sure the Wheel Drive Pins engage the wheels.
3. Do not operate the tiller without wearing adequate outer garments. Avoid loose garments or jewelry that could get caught in moving parts of the tiller or its engine.
4. Do not operate the tiller when barefoot or wearing sandals, sneakers, or light footwear. Wear protective footwear which grips well on slippery surfaces.
5. Do not till near underground electric cables, telephone lines, pipes or hoses. If in doubt, contact your telephone or utility company.
6. Handle fuel with care; it is highly flammable and its vapors are explosive. Take the following precautions:
 - a. Use an approved fuel container.

- b. The gas cap shall never be removed or fuel added while the engine is running. Allow the engine to cool for several minutes before adding fuel.
 - c. Keep matches, cigarettes, cigars, pipes, open flames, and sparks away from the fuel tank and fuel container.
 - d. Fill fuel tank outdoors with extreme care. Never fill fuel tank indoors. Use a funnel or spout to prevent spillage.
 - e. Replace all fuel tank and container caps securely.
 - f. If fuel is spilled, do not attempt to start the engine, but move the machine away from the area of spillage and avoid creating any source of ignition until fuel vapors have dissipated.
7. Never make adjustments when engine is running (unless recommended by manufacturer).

OPERATION

1. Do not put hands or feet near rotating parts.
2. Exercise extreme caution when on or crossing gravel drives, walks, or roads. Stay alert for hidden hazards or traffic. Do not carry passengers.
3. After striking a foreign object, stop the engine (and remove the Ignition Switch Key on electric start models), disconnect the spark plug wire and prevent it from touching the spark plug, carefully inspect the tiller for any damage, and repair the damage before restarting and operating the tiller.
4. Exercise caution to avoid slipping or falling.
5. If the machine should start to vibrate abnormally, stop the engine (and remove the Ignition Switch Key on electric start models). Disconnect the spark plug wire and prevent it from touching the spark plug, and check immediately for the cause. Vibration is generally a warning of trouble.

6. Stop the engine (and remove the Ignition Switch Key on electric start models), disconnect the spark plug wire and prevent it from touching the spark plug whenever you leave the operating position, before unclogging the tines, or when making any repairs, adjustments or inspections.
7. Take all possible precautions when leaving the machine unattended. Stop the engine. Remove Ignition Key on electric start models. Disconnect spark plug wire and move it away from the spark plug. Move Wheel Gear Lever to "ENGAGE" on Econo-Horse and Pony models. On Junior models, the Wheel Drive Pins must engage the wheels.
8. Before cleaning, repairing, or inspecting, stop the engine, remove the Ignition Switch Key on electric start models, and make certain all moving parts have stopped. Disconnect the spark plug wire and prevent it from touching the spark plug to prevent accidental starting. On electric start models, always remove the cable from the negative side (-) of the battery.
9. Always keep the tiller tine hood flap down, unless using the tiller/furrower attachment.
10. Never use the tiller unless proper guards, plates, or other safety protective devices are in place.
11. Do not run engine in an enclosed area. Engine exhaust contains carbon monoxide gas, a deadly poison that is odorless, colorless, and tasteless.
12. Keep children and pets away.
13. Never operate the tiller under engine power if the Econo-Horse or Pony Wheel Gear Lever is in "DISENGAGE" (FREEWHEEL), or if the Junior Wheel Drive Pins do not engage the wheels. In this position, the wheels will not hold the tiller back and the revolving tines could propel the tiller rapidly, possibly causing loss of control. Always move the Wheel Gear Lever to "ENGAGE" (or, on the Junior, ENGAGE the wheels with the Wheel Drive Pins) before starting the engine or engaging the tines / wheels with the Forward Clutch or the Maneuvering Clutch.
14. Be aware that the tiller may unexpectedly bounce upward or jump forward if the tines should strike extremely hardpacked soil, frozen ground, or buried obstacles like large stones, roots, or stumps. If in doubt about the tilling conditions, always use the following operating precautions to assist you in maintaining control of the tiller:
 - a. Walk behind and to one side of the tiller, using one hand on the handlebars. Relax your arm, but use a secure hand grip.
 - b. Use shallower depth regulator settings, working gradually deeper with each pass.
 - c. Place the forward drive belt in its LOW Range position (Econo-Horse only). Use slower engine speeds.
 - d. Clear the tilling area of all large stones, roots and other debris.
 - e. Avoid using downward pressure on handlebars. If need be, use slight upward pressure to keep the tines from digging too deeply.
- f. Before contacting hardpacked soil at the end of a row, reduce engine speed and lift handlebars to raise tines out of the soil.
- g. **In an emergency, stop tines and wheels by releasing whichever Clutch Lever is engaged. Do not attempt to restrain the tiller.**
15. Do not overload the tiller's capacity by attempting to till too deeply at too fast a rate.
16. Never operate the tiller at high transport speeds on hard or slippery surfaces. Look behind and use care when backing up.
17. Do not operate the tiller on a slope that is too steep for safety. When on slopes, slow down and make sure you have good footing. Never permit the tiller to freewheel down slopes.
18. Never allow bystanders near the unit.
19. Only use attachments and accessories that are approved by Garden Way Inc.
20. Use tiller attachments and accessories when recommended.
21. Don't use the tiller in bad visibility or poor light.
22. Never operate the tiller if you are tired, or under the influence of alcohol, drugs or medication.
23. Operators shall not tamper with the engine-governor settings on the machine; the governor controls the maximum safe operating speed to protect the engine and all moving parts from damage caused by over-speed. Authorized service shall be sought if a problem exists.
24. Do not touch engine parts which may be hot from operation. Let parts cool down sufficiently.
25. The battery on electric start model tillers contains sulfuric acid. Avoid contact with skin, eyes, or clothing. Keep out of the reach of children.

Antidote—**External Contact:** Flush immediately with lots of water.

Antidote—**Internal:** Drink large quantities of water or milk. Follow with milk of magnesia, beaten eggs or vegetable oil. Call a doctor **immediately.**

Antidote—**Eye Contact:** Flush with water for 15 minutes. **Get prompt medical attention.**
26. Batteries produce explosive gases. Keep sparks, flame, and smoking materials away. Ventilate when charging batteries or when using a battery in an enclosed space. ALWAYS wear safety goggles when working near batteries.
27. Please remember: You can always stop the tines and wheels by releasing the Forward Clutch Lever or the Maneuvering Clutch Lever (whichever lever you have engaged) or by moving the Throttle Control Lever to STOP.
28. To load or unload the tiller, see the instructions in Section 4 of this Manual.
29. Use extreme caution when reversing or pulling the machine towards you.
30. Start the engine carefully according to instructions and with feet well away from the tines.
31. Never pick up or carry a machine while the engine is running.

MAINTENANCE AND STORAGE

1. Keep the tiller, attachments and accessories in safe working condition.
2. Check all nuts, bolts, and screws at frequent intervals for proper tightness to be sure the equipment is in safe working condition.
3. Never store the tiller with fuel in the fuel tank inside a building where fumes may reach an open flame or spark (hot water and space heaters, furnaces, clothes dryers, stoves, electric motors, etc.).
4. Allow the engine to cool before storing it.
5. To reduce the chances of a fire hazard, keep the engine free of grass, leaves, or excessive grease.
6. Store gasoline in a cool, well-ventilated area, safely away from any spark or flame-producing equipment. Store gasoline in an approved container, safely away from the reach of children.
7. Refer to the Tiller and Engine Maintenance section of this Manual for instructions if the tiller is to be stored for an extended period.
8. Never perform maintenance while the engine is running or the spark plug wire is connected, except when specifically instructed to do so.
9. If the fuel tank has to be drained, do this outdoors.

DECALS

If any of the decals below become illegible, damaged, or missing, contact us or your authorized dealer immediately for a replacement. Use the appropriate part number noted in your Parts Catalog.

Control Panel Decal
(located on upper handlebars):
All Models

Starting Stabilization Decal
(on top of engine or on air cleaner)
All Models

Warning – Ignition Keyswitch
(on Keyswitch)
Pony Model only

Warning Hot Surfaces
(on engine)
Econo-Horse &
Junior Models

Warning – Hot Surfaces & Belts
(on belt cover)
All Models

Operating Instructions
(located on the hood):
All Models

Warning – Belt Positions
(on belt cover – not shown)
Econo-Horse Model only

Photo 1-1: Pony Model shown

Section 2: Easy Assembly

Please follow the steps in this Section to assemble your ECONO-HORSE™, PONY® or JUNIOR® Model tiller and prepare it for use. Due to assembly similarities, we show one model in the assembly photos to represent the three tiller models. Steps unique to any single model(s) are noted. These steps will not take long and will assure correct assembly of your new tiller. We recommend you read this Section all the way through first. Then begin the assembly steps.

STEP 1: UNPACKING AND LOOSE PARTS

Your tiller was shipped fully assembled except for the parts shown in Photos 2-1 and 2-2. The small hardware items are inside a plastic bag within the literature package.

If you ordered an electric start PONY® Model Tiller, you also get a second plastic bag with electric start parts and hardware – it is near the battery. The battery will be in place on its platform or in its own carton. These parts are called out later in this section.

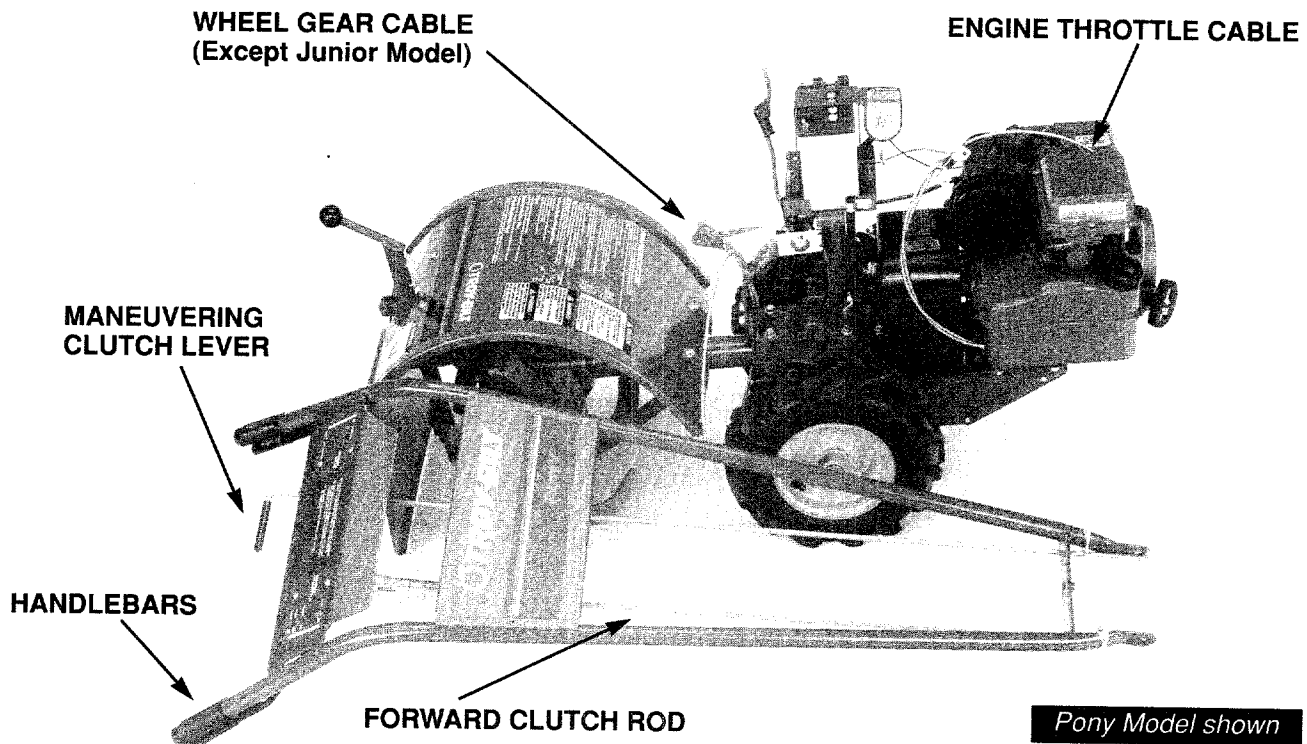

Photo 2-1: Contents of the shipping carton.

The items in the following list are found in your hardware bag. They are keyed to Photo 2-2.

1. One Handlebar Height Adjustment Handle.
2. One keyed washer.
3. Four plastic tie straps (Junior requires two).
4. Three hairpin cotter.
5. Two 3/8" - 16 x 1" hex head bolts.
6. Two 3/8" flat washers.
7. Two 3/8" - 16 nylon insert lock nuts.
8. One Engine Throttle Lever Knob.
9. Four #10 - 32 x 1/2" slotted head screws (Junior requires two).
10. Four #10 lockwashers (Junior requires two).
11. Four #10 - 32 nuts (Junior requires two).
12. One Wheel Gear Lever knob (Econo-Horse and Pony).

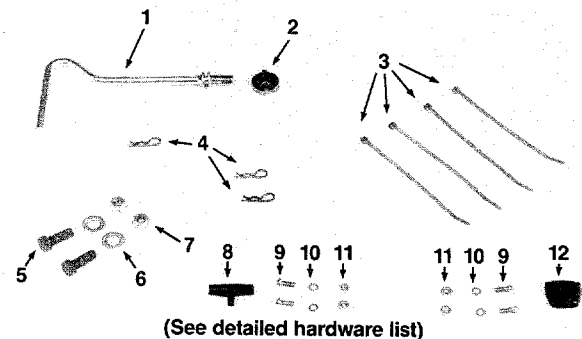

Photo 2-2: Contents of Hardware Package.

Compare the parts that you received to those shown in Photos 2-1 and 2-2. If you are missing any items, please call us at one of the telephone numbers listed on page 3 of this Manual.

If you notice any freight damage, either at the time of delivery or later during assembly, contact the freight terminal and tell them you will be filing a written claim (do so within 15 days). The terminal will advise you as to how to proceed. However, if you meet any problems with this procedure, please call us so we can provide assistance.

Before you attempt to move the tiller off the shipping carton platform, please install the handlebars (Step 2). With the handlebars installed, you'll have better leverage and be more easily able to move the tiller to a level area so you can continue assembly. (Discard all rubber bands securing the handlebars.)

You'll need the following tools to assemble your tiller:

1. Two 9/16" wrenches. *
2. One medium-size flat blade screwdriver.
3. One open end 3/8" wrench.*
4. Scissors (to trim the plastic ties).
5. One 7/16" wrench (electric models only).*
6. A piece of wood to tap the knobs securely on the control levers.
7. Automotive-type tire pressure gauge.
8. Ruler.
9. Sturdy wood box or block 2-1/2"—3-1/2" high (Junior Model only).

* You may substitute adjustable wrenches.

To Remove Tiller From Shipping Platform:

Before moving the tiller off its shipping platform, you must move the Wheel Gear Lever (on Econo-Horse and Pony models) to the "DISENGAGE" position. For shipping purposes, the Wheel Gear Cable is wrapped around the transmission tube, between the engine and the tine hood. Unwrap the Wheel Gear Cable and move the Wheel Gear Lever at the end of the cable to its "DISENGAGE" position as shown in Photo 2-3. On the Junior Model, a Wheel Drive Pin must be removed from the hub of each wheel, the wheels moved inward as far as possible, and the Wheel Drive Pins replaced through the wheel shaft holes and secured with their cotter pins. Each wheel is then free to turn on the wheel shaft. See Inset Photo at right.

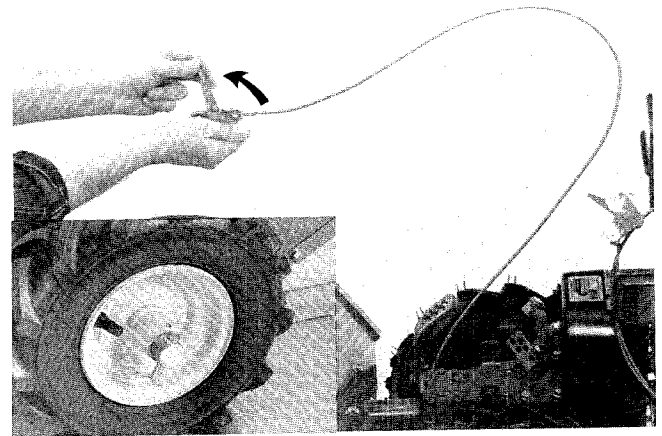

Photo 2-3: Pull the Wheel Gear Lever back to "Disengage" position on Econo-Horse and Pony models. Inset Photo shows Wheel Drive Pins that need to be moved on the Junior Model.

STEP 2: ATTACHING THE HANDLEBARS

1. On electric start models **only**, remove one of the bolts and lockwashers that secures the lower end of the curved height adjustment bracket to the back of the transmission. Loosen the second bolt so you can swing the curved height adjustment bracket out of the way. See Photo 2-4.

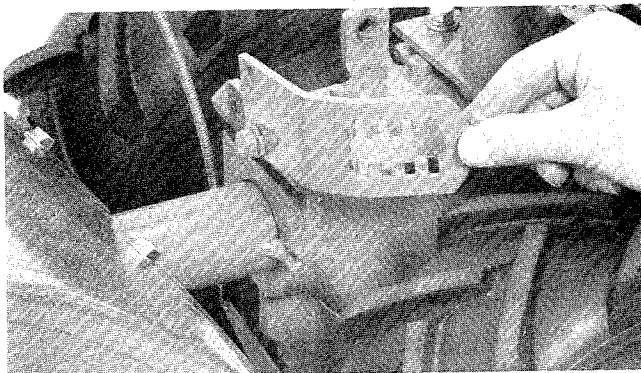

Photo 2-4: Swing the Height Adjustment Bracket down to one side (Electric start models only).

2. Remove the Maneuvering Clutch Lever from the handlebars. See Photo 2-5.

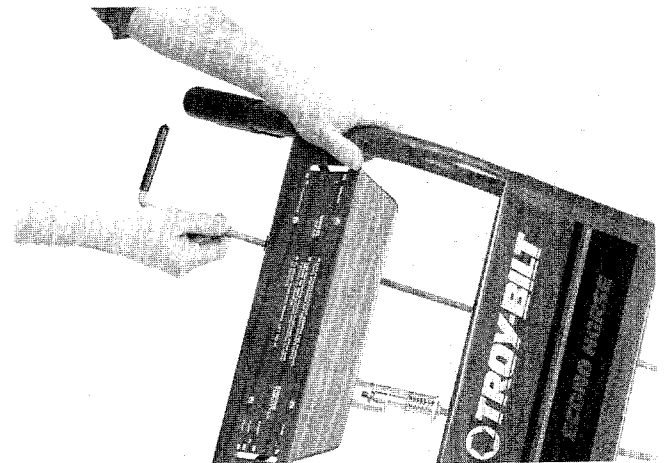

Photo 2-5: Removing the Maneuvering Clutch Lever from the handlebars. Just slide it out.

3. Place the lower end of the handlebars on the outside of the two mounting tabs on the top of the transmission. Be sure the handlebar cross-brace (on the lower end of the handlebars) goes under the curved height adjustment bracket.

4. Secure the lower ends of the handlebar to the two mounting tabs with a 3/8"-16 x 1" bolt, a 3/8" flat washer, and a 3/8"-16 nylon insert lock nut. Use 9/16" wrenches. Both bolt heads should be inserted from the inner side of the mounting tab.

5. On electric start models, move the curved height adjustment bracket back in place. Reinstall the bolt and lockwasher you previously removed. Tighten both bolts very securely.

6. Move the handlebar up (or downward) to align the hole in the handlebar cross brace with one of

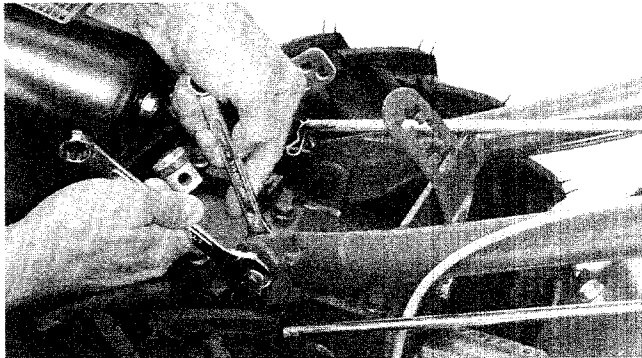

Photo 2-6: Attaching the handlebars.

the four slots in the curved height adjustment bracket. See Photo 2-7. Place the keyed washer on the Height Adjustment Handle. Screw the handle into the hole in the handlebar cross brace. Make sure that both raised keys on the bottom of the keyed washer fit into one of the four slots on the bracket. Tighten the Handlebar Height Adjustment Handle securely. Also tighten the hardware securing the ends of the handlebar to the two mounting tabs.

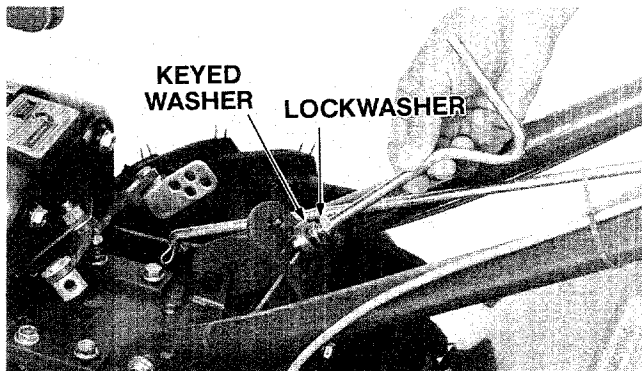

Photo 2-7: Installing the Handlebar Height Adjustment Handle.

7. With the handlebars installed, you can now easily move the tiller off its shipping platform.

Note: Out in the garden you may need to readjust handlebar height again for comfort. See Handlebar Height Adjustment, page 21.

STEP 3: ATTACHING THE MANEUVERING CLUTCH LEVER

1. Slide the Maneuvering Clutch Lever down through the hole in the left-hand side of the handlebar control panel. Make sure that the Maneuvering Clutch Lever passes above the cross brace on the lower end of the handlebar.

2. Turn the Maneuvering Clutch Lever so the small bend on the lower side points inward.

3. Insert the lower end of the Maneuvering Clutch Lever into the hole in the pivot as shown in Photo 2-8. Secure the Maneuvering Clutch Lever in place by inserting a hairpin cotter down through the hole in the end of the Maneuvering Clutch Lever.

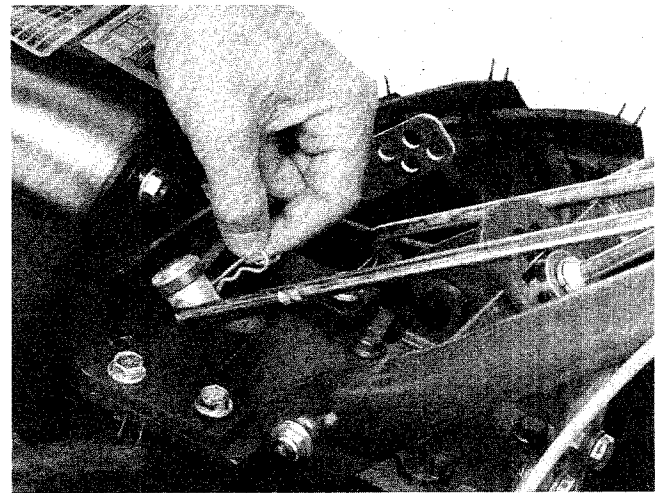

Photo 2-8: Installing Maneuvering Clutch Lever.

STEP 4: CONNECTING THE FORWARD CLUTCH ROD

1. Turn the Forward Clutch Rod so the small bend at the lower end points inward.

2. Insert a hairpin cotter down into the inner hole in the small bend of the Forward Clutch Rod.



Photo 2-9: Connecting the Forward Clutch Rod.

3. Note the four holes in the swivel plate on the shifting mechanism. **The hole that you must insert the lower end of the Forward Clutch Rod into depends upon which handlebar height setting (on the curved handlebar height adjustment bracket) you have the handlebars set at.** Refer to Photo 2-10 to determine which hole in the swivel plate to use. For example: if you set the handlebar in slot number 1, then the Forward Clutch Rod must be installed in hole number 1 of the swivel plate.

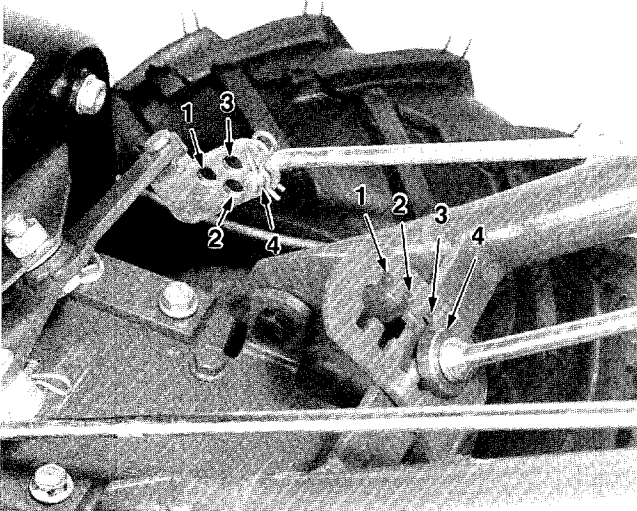

Photo 2-10: Handlebar Height setting and Forward Clutch Rod positioning are interrelated. They must both be set in the same numbered positions.

4. Insert the lower end of the Forward Clutch Rod into the proper hole in the swivel plate. Secure it to the swivel plate by inserting a hairpin cotter through the outer hole in the small bend of the Forward Clutch Rod.

IMPORTANT

Whenever the handlebar height is changed, the position of the Forward Clutch Rod must be changed accordingly. Changing the handlebar height changes the tension on the Forward Clutch Rod. This tension must be adjusted by relocating the rod in the appropriate hole in the clutch swivel plate.

5. **To make sure the tension on the Forward Clutch Rod (once connected) is correct:**
- Stand on the right-hand side of the tiller and pull the Forward Clutch Lever up and hold it in place. See Photo 2-11.
 - Check the gap between the "E-ring" and the lower end of the bracket at the upper end of the Forward Clutch Rod. Refer to Photo 2-11. The gap should be 3/16"-to-5/16". If you do not have a ruler handy, the thickness of five pennies is approximately 5/16" thick.

- If the gap is incorrect, reverify that the Forward Clutch Rod is located in the correct hole in the swivel plate. If it isn't, move the lower end of the Forward Clutch Rod into the correct hole and then check the measurement gap again.
- To reset the gap distance properly, you must make a simple adjustment to the *length* of the Forward Clutch Rod. To do this, disconnect it from the swivel plate, then rotate it clockwise or counterclockwise to shorten or lengthen the rod. Reconnect it and measure the gap again as shown below in Photo 2-11. Adjust the length of the rod until the gap is within 3/16" to 5/16".

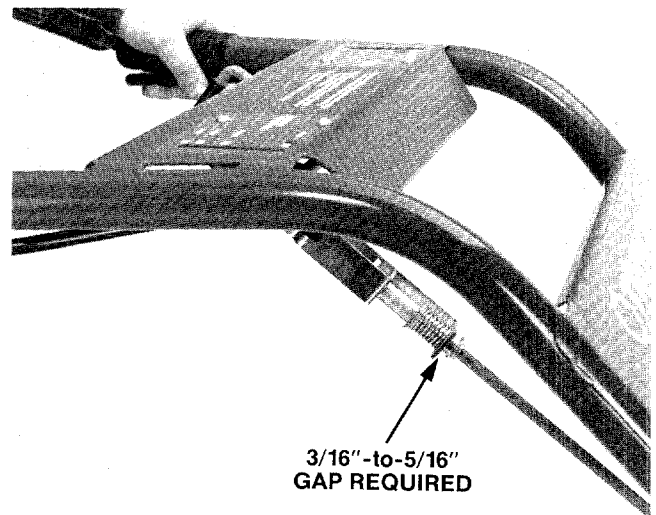

Photo 2-11: Carefully measure the gap between the Forward Clutch Bracket and the "E-Ring."

STEP 5: CHECKING THE TRANSMISSION GEAR OIL LEVEL

Once the handlebars are securely installed on the tiller, move the tiller to a level area.

We have installed gear oil in the tiller transmission here at the Factory. **However, you should make this very important check to be sure that the gear oil level is still correct.**

- Make sure that your tiller is on a level area.
- Lower the depth regulator lever to the second notch to make sure that the transmission is as level as possible. (See Photo 2-12.). **NOTE** — For shipping purposes, the depth regulator lever might be secured with a plastic tie. If so, before the depth regulator lever can be lowered, you must lift the hood flap at the rear of the tiller and cut and remove the tie.

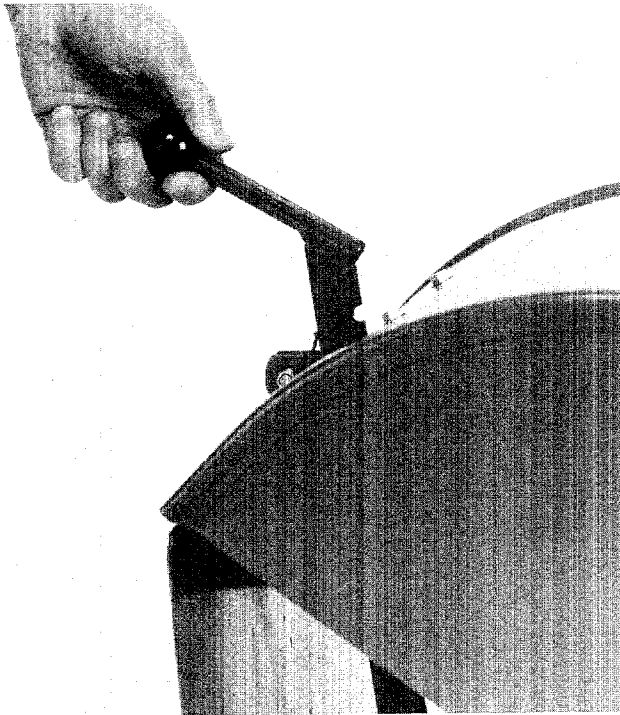

Photo 2-12: Move Depth Regulator Lever to second notch.

3. Use a 3/8" open end wrench to remove the transmission oil level check plug (on the left-hand side of the transmission). Due to dried paint on the plug threads, it may require some force to remove the plug the first time. If the transmission oil level is correct, oil should start to flow out of the hole. If oil flows from the hole, your check is finished; reinstall the plug and tighten it securely with a 3/8" open end wrench.

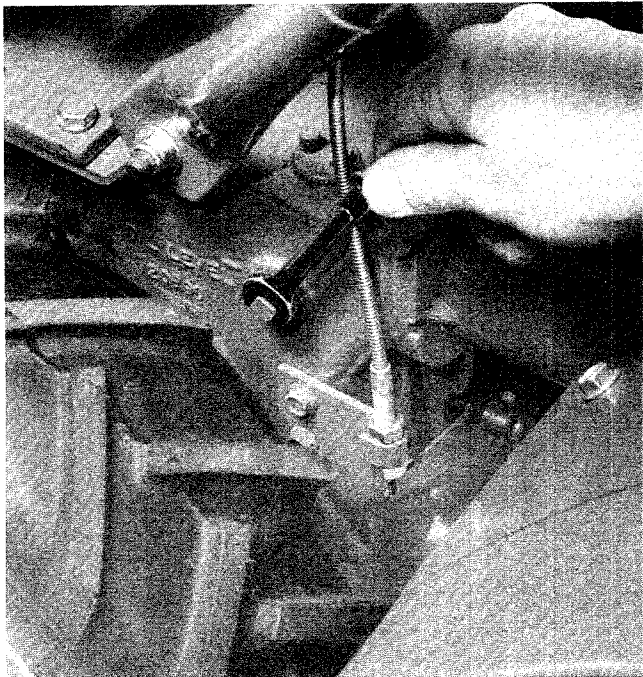

Photo 2-13: Removing the transmission Oil Level Check Plug. When the level is correct, gear oil will flow from this check hole.

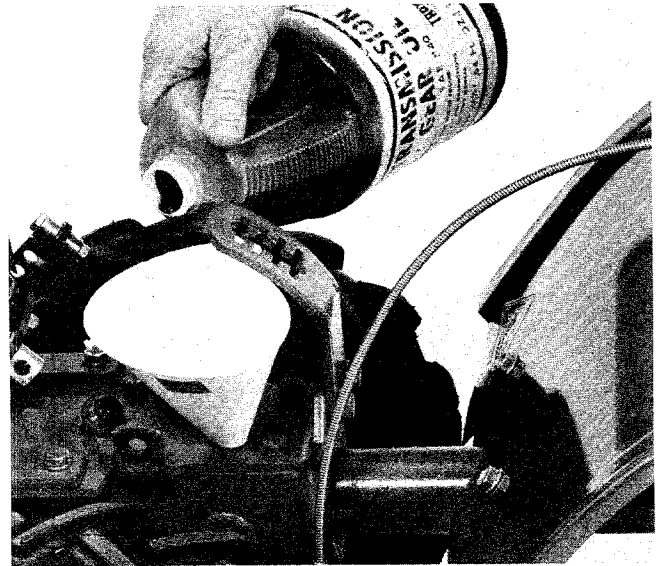

Photo 2-14: Adding gear oil to transmission.

4. If no oil flowed from the transmission oil level check hole, add **SAE 140, SAE 85W-140 or SAE 80W-90 weight gear oil** to bring the oil up to the correct level. Preferably use API rated GL-4 gear oil (GL-5 is permissible for small top-offs). Use this procedure:

- a. Unscrew filler plug from top left-hand side of transmission. Clean around plug first.
- b. Insert a **clean** funnel into the oil fill hole and slowly add gear oil until it flows from the transmission oil check hole.
- c. Reinstall the transmission oil check plug. Tighten securely with the 3/8" wrench.
- d. Reinstall the transmission oil fill plug. Tighten it securely by hand.

STEP 6: ADD MOTOR OIL TO THE TILLER ENGINE

The tiller engine was shipped without motor oil in it. You must add motor oil before starting the engine. (See Figure 2-15A and Photo 2-15B on page 12.) Use quality motor oil with API classification SF, SG, SH, or SH/CD. The viscosity depends upon whether you have a Briggs & Stratton or a Tecumseh engine, and on temperature. See Pages 48-49 or engine manufacturer literature for oil recommendations.

To add motor oil to the engine:

1. Make sure that the tiller is on level ground. Lower the depth regulator lever to the second notch (placing the tiller in a level position).
2. Wipe the area around the dipstick or oil fill tube clean so no debris will fall into the engine.
3. On the Econo-Horse 6HP Tecumseh engine, unscrew the engine oil dipstick from the fill hole. See Figure 2-15A. Add oil until the level reaches "Full" on the dipstick. Do not overfill with oil.

4. On the Pony 5HP Briggs & Stratton engine and on the Junior 4HP Tecumseh engine, remove the filler cap from the oil fill tube at the side of the engine. See Photo 2-15B. Add oil until it reaches the very top of the oil fill tube. Replace the filler cap securely.

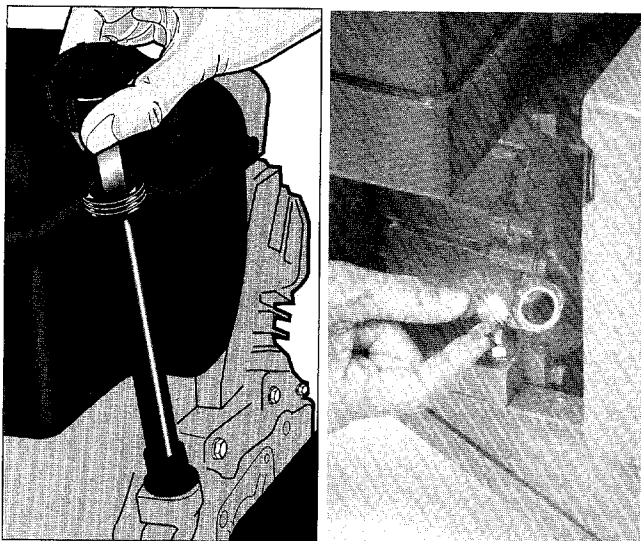

Figure 2-15A (left): On 6HP Tecumseh engines, add oil and check the oil level with the dipstick. Photo 2-15B (right): On 5HP Briggs & Stratton and 4HP Tecumseh engines, add oil until it reaches the top of the oil fill tube. Replace the fill cap securely.

STEP 7: ATTACHING THE ENGINE THROTTLE LEVER TO THE CONTROL PANEL

The engine throttle cable (with lever) is wrapped around the engine for shipping. Unwrap it and attach the cable as follows:

1. Locate two #10-32 x 1/2" slotted head screws, two #10-32 nuts, and two #10 lockwashers in your hardware bag. Keep this hardware at hand so you can attach the Engine Throttle Lever to the control panel.
2. Run the engine throttle cable alongside the right-hand handlebar.
3. Position the Engine Throttle Lever beneath the control panel. Insert the lever up through the slot in the control panel that is marked "ENGINE THROTTLE."
4. Insert each of the screws through a "+" mark on the control panel decal. Align the holes in the Engine Throttle Lever base with the screws and be sure the screws go through the base.

5. Snug the base of the throttle lever up against the bottom of the control panel. Install a lockwasher and a nut on each of the threaded ends of the screws. Use a 3/8" wrench and a flat tip screwdriver to tighten both screws.

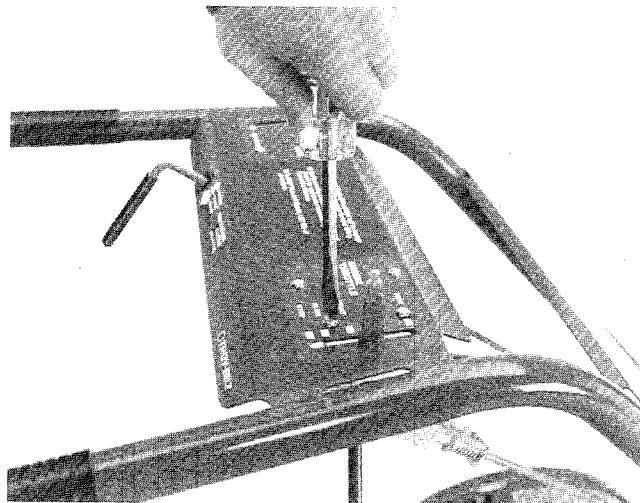

Photo 2-16: Installing Engine Throttle Lever.

6. Place the "T-shaped" Engine Throttle Lever knob on the end of the Engine Throttle Lever. Use the piece of wood to tap the knob until it seats firmly on the Engine Throttle Lever.

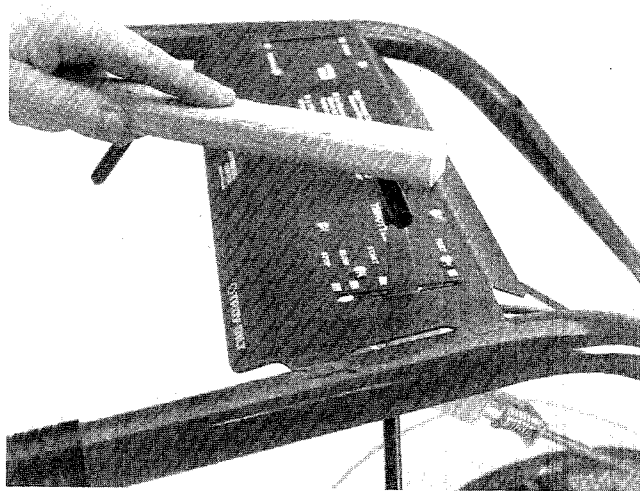

Photo 2-17: Install the Engine Throttle Lever Knob.

7. Move the Engine Throttle Lever forward and backward to check its movement. It should move smoothly through the full range of its travel. Please note there is a detent (a catch) at "SLOW." This prevents you from unintentionally shutting off the engine when you are just trying to slow the engine down. If it is difficult to move the Engine Throttle Lever away from "STOP", loosen both screws and move the lever assembly slightly to the left. Tighten both screws and re-check the Engine Throttle Lever's movement. Spend a couple of minutes adjusting this assembly until the lever moves smoothly.

8. Take two of the red plastic ties from the hardware bag. Locate them as shown in Photo 2-18. Space them about two feet apart.

The serrated side of each plastic tie should be on the inside of the loop when you wrap the tie around the handlebar and Engine Throttle Lever cable. Tighten each tie by pulling on the free end. Snip off any excess with a scissor.

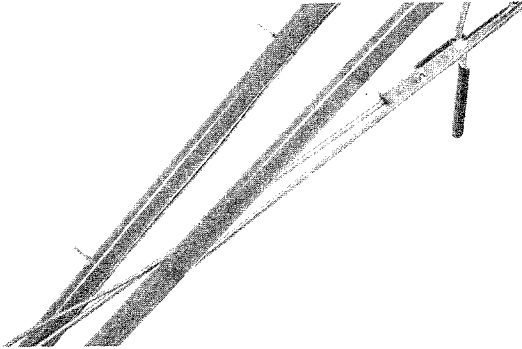

Photo 2-18: Secure Engine Throttle Cable to Handlebars with two plastic ties.

STEP 8: ATTACHING THE WHEEL GEAR LEVER TO THE CONTROL PANEL (Econo-Horse and Pony Models only)

The Wheel Gear cable is wrapped around the transmission for shipping purposes. Unwrap the cable and install it as follows:

1. Locate the last two #10-32 x 1/2" slotted head screws, #10-32 nuts, and #10 lockwashers.
2. Position the Wheel Gear cable along the side and up the left handlebar.
3. Position the Wheel Gear Lever beneath the control panel. Insert the lever up through the slot in the panel marked "WHEEL GEAR."
4. Insert both of the screws through a "+" mark on the control panel decal. Align the holes in the Wheel Gear Lever base with the screws and place the base over the screws.
5. Double check to make sure that the screws go through the holes in the lever's base. Install a lockwasher and nut on each of the screws. Use a 3/8" wrench and a flat tip screwdriver.

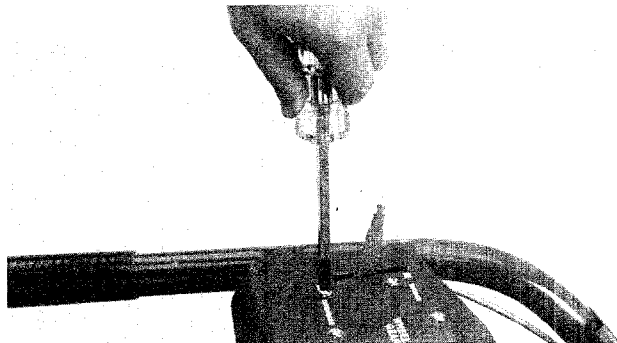

Photo 2-19: Installing the Wheel Gear Lever. (Econo-Horse and Pony Models only.)

6. Place the Wheel Gear Lever knob on the end of the Wheel Gear Lever. Use the piece of wood to tap the knob until it seats on the lever.

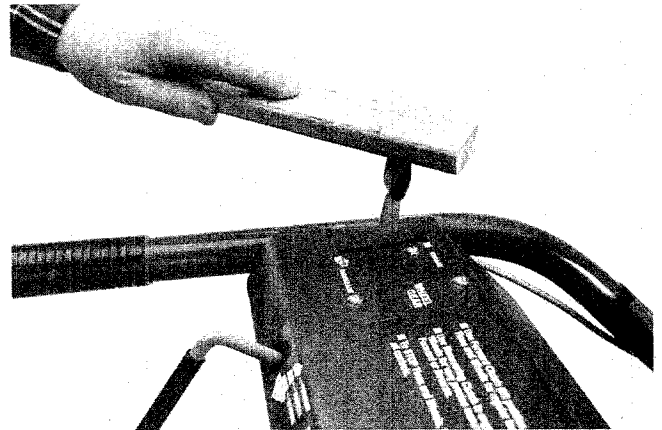

Photo 2-20: Installing Wheel Gear Lever Knob. (Econo-Horse and Pony Models only.)

7. Use the two remaining plastic ties in the hardware bag to secure the Wheel Gear cable to the left-hand handlebar. Position the ties as shown in Photo 2-21. Remember that the serrated side of the tie should be on the inside when you loop the tie around the handlebar and Wheel Gear cable. After you've tightened the ties by pulling on the loose ends, snip off any excess.

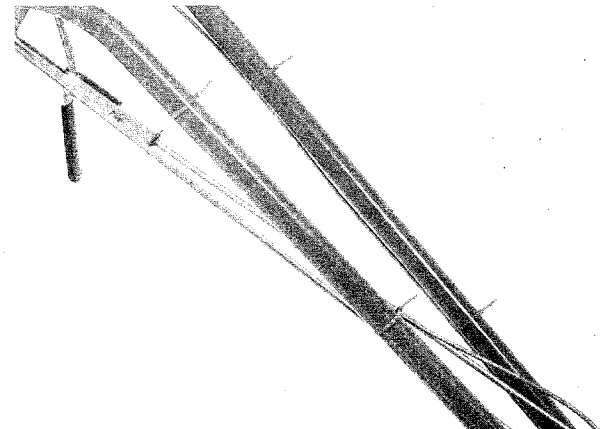

Photo 2-21: Secure Wheel Gear Cable to Handlebar. (Econo-Horse and Pony Models.)

STEP 9: ADJUSTING THE AIR PRESSURE IN THE TIRES

To be sure of a good seal between the tires and wheels, we've inflated your tiller's tires above the recommended operating pressure.

Before using your tiller, be sure to evenly deflate both tires until their pressure is 15 to 20 psi (pounds per square inch). You can check the air pressure with an automotive-type tire pressure gauge.

Be sure that both tires have the same air pressure or the tiller will pull to one side when you are using it.

If you have a standard start **ECONO-HORSE™**, **PONY®** or **JUNIOR®** Tiller, it is now completely assembled and ready to be used.

Please read the rest of this Owner/Operator Manual before you begin to operate your tiller.

You should become very familiar with, and follow all the safety rules, the tiller operating instructions, and the engine operating instructions at all times.

If you have an Electric Start **PONY®** Tiller, you will have to perform the following steps to assemble the electric starting system on your tiller.

ASSEMBLING THE PONY ELECTRIC START SYSTEM

Compare the parts in your tiller's electric start hardware package with the parts shown in Photo 2-22. The parts listed below are keyed to the hardware items in the photo.

1. Battery (for shipping purposes, it is either secured to the battery support bracket or in a protective carton).
2. Vent tube.
3. Screws and nuts (used to attach battery cables to battery).

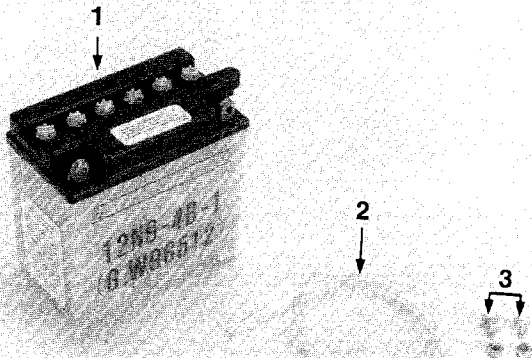

Photo 2-22: The Electric Start parts.

STEP 10: BATTERY ACTIVATION AND CHARGING

NOTE

Your battery was shipped to you DRY. You must have battery electrolyte solution (battery grade sulfuric acid) added to the battery. You then must have the battery fully charged before using it on your tiller.

DANGER

- Electrolyte is a sulfuric acid solution.
- Avoid spillage and contact with skin, eyes, and clothing.
- To prevent accidents, wear protective clothing, rubber gloves, and shield eyes with safety goggles when working near battery.
- Neutralize acid spills with baking soda and water solution. Neutralize empty container with baking soda and rinse with water.

ANTIDOTE: External contact: Flush with water. **Eyes**—Flush with water for 15 minutes and get prompt medical attention.

ANTIDOTE: Internal: Drink large quantities of water or milk. Follow with milk of magnesia, beaten eggs, or vegetable oil. Call physician immediately.

DANGER

BATTERIES PRODUCE EXPLOSIVE GASES!

- Keep sparks, flame, and cigarettes away.
- Ventilate area when charging or using battery in an enclosed space.
- Make sure venting path of battery is always open once battery is filled with acid.

Adding electrolyte to the battery and charging the battery can be dangerous. The sulfuric acid in the electrolyte can severely burn you or blind you. Also, a battery that is charging gives off gases that could explode if a spark or flame should contact the gases.

We strongly recommend that you take your battery to a TROY-BILT tiller dealer, a reliable service station, battery store, or farm equipment store where a trained battery technician can complete the job safely.

PLEASE DO NOT ATTEMPT TO ACTIVATE THE BATTERY UNLESS YOU ARE FULLY EXPERIENCED IN BATTERY SET-UP AND CHARGING PROCEDURES.

To ensure proper activation of your battery, we suggest you review the following activating and charging instructions with your battery technician and make sure that he follows the instructions.

To Activate the Battery:

1. Place the battery on a level area away from any spark- or flame-producing sources such as a gas stove, heater, electrical switch, pilot light, (etc.).
2. Remove and discard the short sealing tube (if installed) on the battery side vent.
3. Remove the six filler caps that are on top of the battery. Leave the caps off while activating and charging the battery.
4. Carefully fill each of the six cells in the battery with electrolyte (battery grade sulfuric acid that has a specific gravity of 1.265) until the level reaches the "UPPER LEVEL" line on the battery.

NOTE

- The battery and electrolyte should be between 60° and 80° F for best results.
- Do not add water or any other liquid to activate the battery.

5. Allow the battery to stand for thirty minutes. Then check the electrolyte level in each cell. If needed, add more electrolyte to bring the electrolyte level up to the "UPPER LEVEL" line on the battery. Do not overfill the battery as this could lead to flooding from the cells when the battery is being charged.

6. Charge the battery by following the next set of instructions.

To Charge the Battery

To obtain maximum battery life, charge the battery by the following method until all cells are gassing freely. A battery is gassing freely when the surface of the electrolyte is covered with tiny bubbles.

DANGER

When checking the battery for gassing, ALWAYS wear safety goggles and use a flashlight to look down into the cells.

Failure to do so could result in serious personal injury.

Be sure to follow all instructions given by the manufacturer of the battery charging equipment that is being used to charge the battery.

1. Hook up the battery charger and charge the battery approximately three to five hours at one to two amperes. Turn the battery charger OFF.
2. If the electrolyte level has fallen after charging, refill the battery with distilled water until the electrolyte level reaches the "UPPER LEVEL" line on the battery.
3. After charging, reinstall the six filler caps on the battery.
4. Unplug the battery charger from the electrical outlet (or turn the battery charger OFF). Then disconnect the cables from the battery posts.
5. Wash any acid spillage off the battery with water. Then dry the battery.

STEP 11: INSTALLING THE BATTERY ON THE TILLER

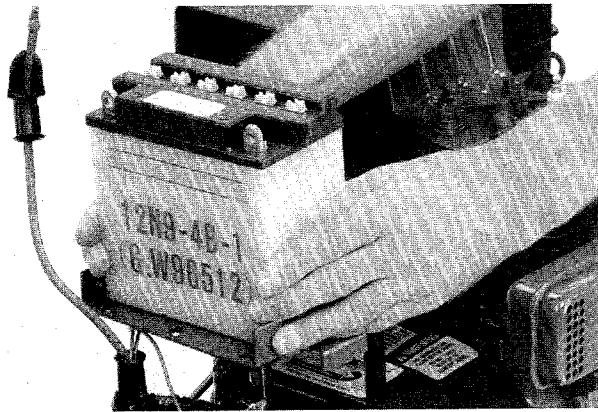

Photo 2-23: Installing the Battery.

1. Use both hands to carefully place the battery on the battery mounting bracket. The battery posts should face to the rear of the tiller. The positive (+) post should be on the left-hand side of the tiller and the negative (-) post should be on the right-hand side of the tiller.

WARNING

- Be sure that the battery is positioned on the tiller as explained in Step 1. Hooking the battery cables to the wrong posts could result in damage to the battery and other electrical parts.

- Do not touch the positive (+) battery post and any surrounding metal with tools, jewelry, or other metal objects. Doing so could cause a short circuit that could result in electrical burns or an explosion of battery gases.

2. Place the battery hold-down bracket over the battery. Center the bolt holes in the lower part of the hold-down bracket with the bolt holes in the battery mounting bracket. Make sure that the Engine Ignition Switch is on the forward side of the battery.

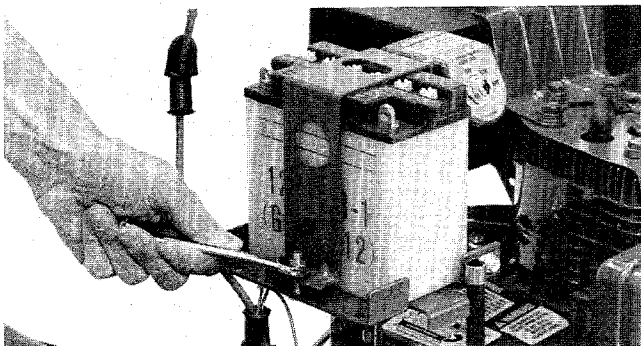

Photo 2-24: Securing the Battery in Place.

3. Use the two 1/4" -20 x 1 1/4" carriage bolts, 1/4" lockwashers, and 1/4"-20 nuts to secure the hold-down bracket to the battery mounting bracket. Insert the bolts from beneath the battery hold-down bracket, up through the battery hold-down bracket, and secure them with the lockwashers and nuts. Use a 7/16-inch wrench to evenly tighten both nuts. Do not tighten the nuts so that the tabs on the battery hold-down bracket become bent.

STEP 12: INSTALLING THE BATTERY CABLES

1. The Positive battery cable is already connected at one end to the solenoid which is mounted a few inches below the battery on a post. You are to connect the loose end of the positive cable to the positive (+) post on the battery. Use a bolt and nut from the hardware bag. Use a screwdriver and a 3/8" wrench to tighten the bolt. See Photo 2-25.

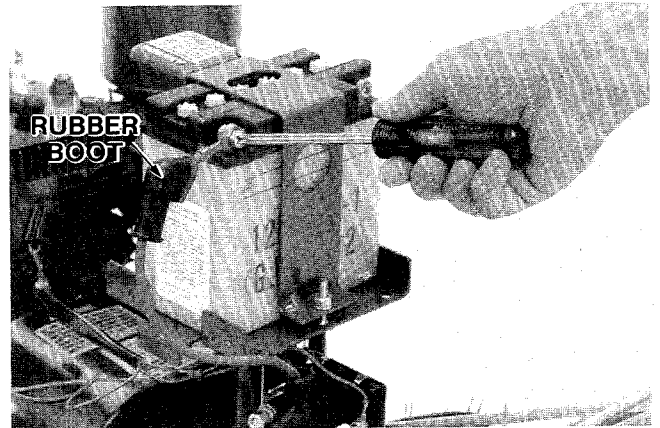

Photo 2-25: Attach Positive Cable to Battery.

2. Slide the black rubber boot up the positive cable and slip it over the positive battery post.

3. The Negative cable is already connected at one end to one of the mounting bolts securing the solenoid to the post. This is the grounding point for the negative cable—connect the loose

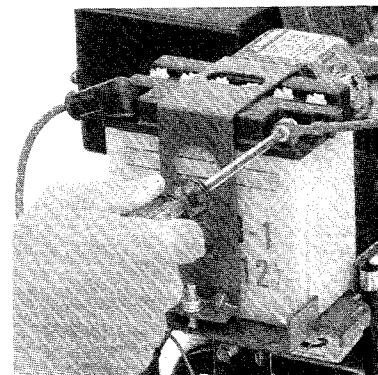

Photo 2-26: Attach the Negative Battery Cable to the battery.

end of the negative (-) cable to the negative battery post. Use the last nut and last bolt to securely attach the negative battery cable to the negative (-) battery post.

4. Use a 3/8" wrench to check the tightness of the upper mounting bolt on the starter solenoid. This bolt secures the Negative Cable to its ground location. Scrape away any paint between the cable and the bolt as this would prevent a proper electrical ground. See Photo 2-27.

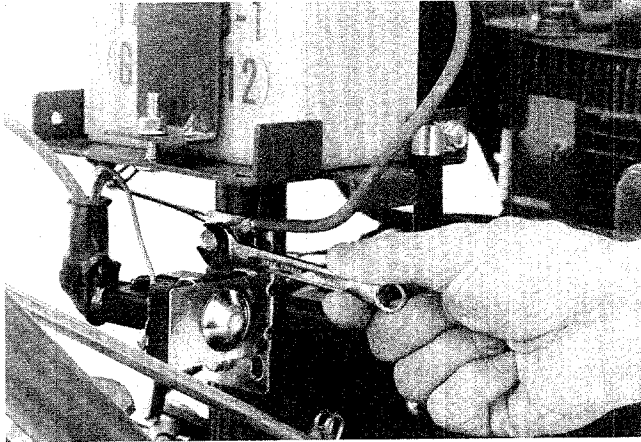

Photo 2-27: The Negative Battery Cable must be securely grounded to the Upper Mounting Bolt on the Solenoid.

STEP 13: INSTALLING THE BATTERY VENT TUBE

1. Push the battery vent tube down into the vent tube sheath. Attach the upper end of the vent tube to the side vent on right side of battery.

! WARNING

Be sure that the vent tube does not become kinked, folded, or pinched when you install it.

Improper venting could cause the battery to explode, resulting in personal injury or property damage.

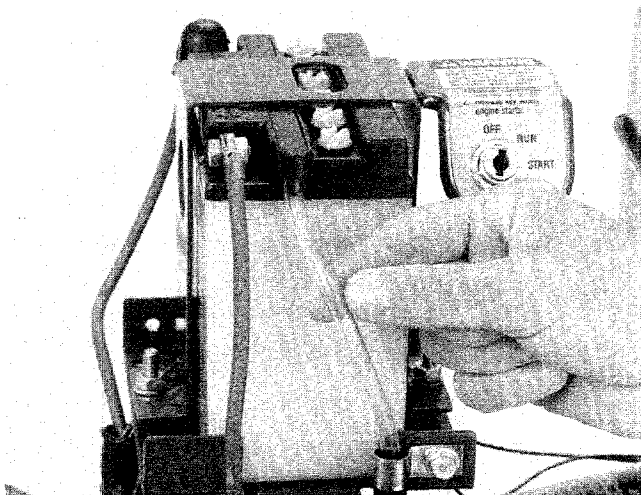
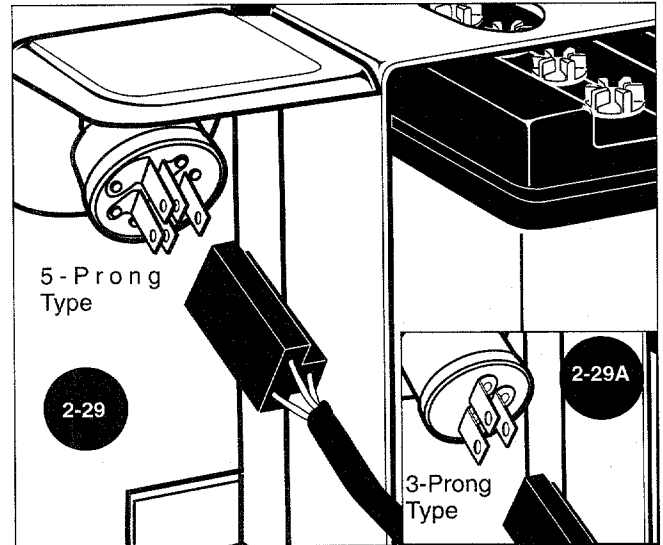

Photo 2-28: Installing the Battery Vent Tube.

STEP 14: CONNECT WIRING HARNESS TO IGNITION KEYSWITCH

Slide the wiring harness connector over the prongs on the back of the Ignition Keyswitch. Your keyswitch has either a 3-prong or 5-prong design. See Sketch 2-29 or 2-29A.



Sketch 2-29: Connect the Wiring Harness to the Ignition Keyswitch. The 5-prong design is shown. Inset Sketch 2-29A—shows the 3-prong type which you may have instead of the 5-prong type.

You're now finished assembling the electric start PONY® Model tiller.

Before you add gasoline to the gas tank and begin to operate the tiller, please read the rest of this Owner/Operator Manual so that you become familiar with the location of, and the operation of, the various tiller and engine controls.

Without starting your tiller's engine, operate the tiller controls so that you understand what each one does. After you've done this, move the tiller to a safe, level area to practice starting the engine and maneuvering the tiller without actually tilling. Make sure that the depth regulator lever is in the "travel" position (one of the higher notches) while you're becoming familiar with your new tiller.

Take this Manual along for ready reference while you're practicing in case you have any questions about operating your tiller.

! WARNING

To avoid serious personal injury or damage to equipment, do not attempt to operate the tiller or its engine until after you've read and understood all of the Safety, Controls, and Operating Instructions in this Manual, in the Engine Owner's Manual, and in other literature you may receive.

Section 3:

Tiller And Engine Controls

Before attempting to operate your new tiller, become thoroughly familiar with the location of and function of all the operational controls.

Practice using these controls—with the engine shut off—until you understand the operation of the controls and feel confident with each one of them.

TILLER CONTROLS

There are four tiller controls you will be using when you operate your tiller. These controls are: the Wheel Gear Lever (ECONO-HORSE and PONY Models only), the Forward Clutch, the Maneuvering Clutch, and Depth Regulator Lever. Refer to Photos below for the location of these controls.

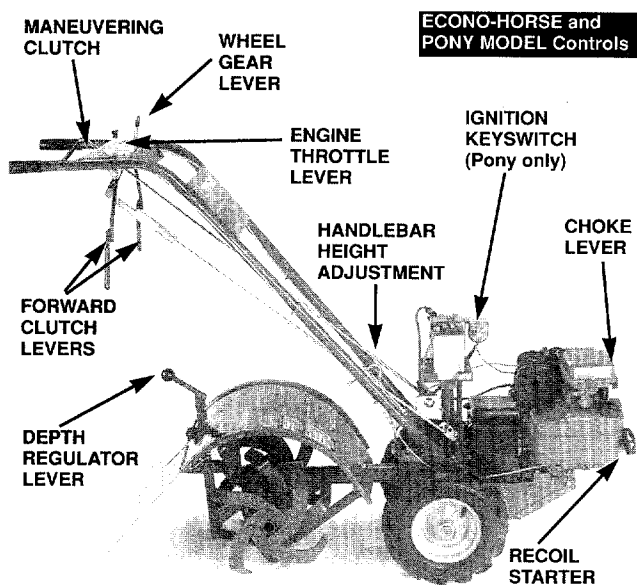

Photo 3-1: Location of controls on the PONY and ECONO-HORSE Models. (Pony Model shown.)

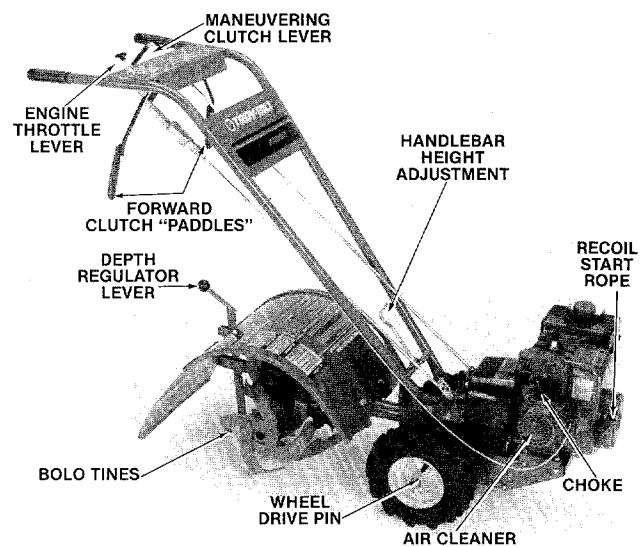

Photo 3-1A: Location of controls on the JUNIOR Model tiller.

Wheel Gear Lever (Econo-Horse and Pony Models only)

This lever is located on the left-hand side of the handlebar control panel. It has two positions: ENGAGE and DISENGAGE (FREE WHEEL).

The ENGAGE position allows power from the engine to turn the wheels and tines whenever:

- a. The Forward Clutch is engaged, OR
- b. The Maneuvering Clutch is engaged in either forward or reverse.

The DISENGAGE (FREE WHEEL) position should only be used when the engine is not running. Use the DISENGAGE (FREE WHEEL) position ONLY when you are rolling the tiller to another location.

DANGER

NEVER place the Wheel Gear Lever in DISENGAGE (FREE WHEEL) when the engine is running.

Having the Wheel Gear Lever in DISENGAGE (FREE WHEEL) and then engaging the tines/wheels with either the Forward Clutch or the Maneuvering Clutch could allow the tines to propel the tiller rapidly forward or backward.

Failure to follow this instruction could result in personal injury or property damage.

To operate the Wheel Gear Lever:

1. Roll the tiller a few inches forward or backward while you gently move the Wheel Gear Lever ahead to ENGAGE. Don't force the lever into ENGAGE (see Pg 43 for lever adjustment).
2. To place the Wheel Gear Lever in DISENGAGE (FREE WHEEL), simply move the lever rearward. You don't have to move the tiller when you move the Wheel Gear Lever into DISENGAGE (FREE WHEEL).

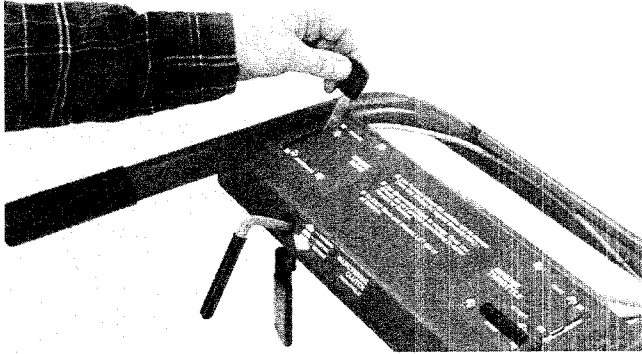

Photo 3-2: The Wheel Gear Lever in "ENGAGE" position. Econo-Horse and Pony Models only.

Wheel Drive Pins (Junior Model only)

Both wheels on the Junior tiller are held in place by a Wheel Drive Pin (Photo 3-2A). The pins are used to engage and disengage drive power to the wheels. Before starting the engine, the Wheel Pins must be in the WHEEL DRIVE position. Do this by inserting the pins through the holes in the wheel hubs AND the holes in the wheel shaft. This "locks" the wheels to the wheel shaft, so they will turn when either the Forward Clutch or the Maneuvering Clutch is engaged.

To move the tiller when the engine is not running, the wheels must be able to "FREE WHEEL". To permit this, insert the Wheel Drive Pins through the wheel shaft holes only. When this is done, the pins will keep the wheels on the wheel shaft, but the wheels will be free to rotate as they are no longer "locked" to the shaft.

WARNING

NEVER operate the tiller under engine power if the wheels are in FREE WHEEL position (Wheel Pins through wheel shaft only). In FREE WHEEL, the wheels will not hold the tiller back and the tines could propel the tiller rapidly, possibly causing loss of control and serious injury or property damage. Always engage the wheels in WHEEL DRIVE position before starting the engine or engaging the Forward Clutch or Maneuvering Clutch.

To Engage the Wheels in WHEEL DRIVE:

- A. Make certain the engine is stopped and the spark plug wire is disconnected.
- B. Raise one wheel off the ground and place a sturdy block beneath the transmission.
- C. Remove the hair pin cotter and pull the Wheel Drive Pin out.
- D. Slide the wheel outward on the shaft and replace the Wheel Drive Pin through the hole in the wheel hub AND the hole in the wheel shaft. Replace the hair pin cotter through the Wheel Drive Pin, pushing the cotter pin in as far as it will go. See Photo 3-2A.
- E. Repeat these steps with the other wheel.

WARNING

To avoid personal injury, do not lay the tiller on its side while adjusting the wheels. This could cause gasoline to leak from the fuel tank, resulting in an unsafe condition.

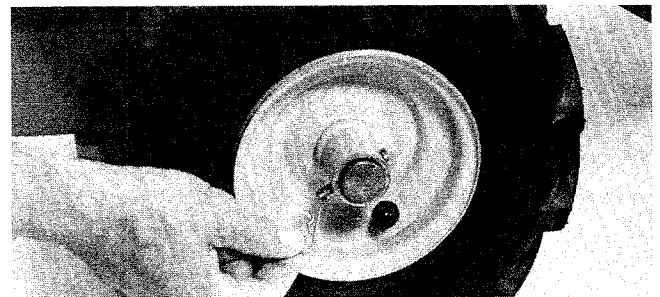

Photo 3-2A: Install Wheel Drive Pin through wheel hub and shaft for WHEEL DRIVE position.

To Engage the Wheels in FREE WHEEL:

- A. Repeat Steps A, B, and C of the previous "Wheel Drive" engagement instructions.
- B. Slide the wheel fully inward on the shaft.
- C. Place Wheel Drive Pin through hole in wheel shaft only, as shown in Photo 3-2B.
- D. Replace the hair pin cotter through the Wheel Drive Pin. Push it in as far as possible.
- E. Repeat Steps A through D with the other wheel. Remove the support block.

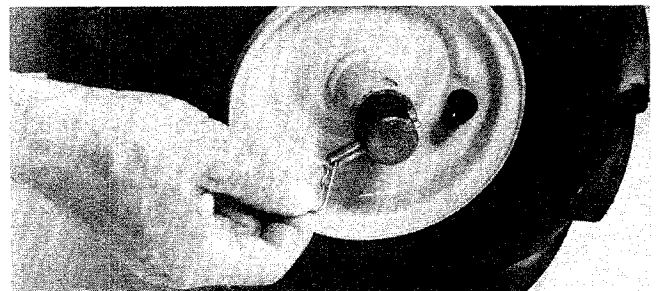

Photo 3-2B: Install Wheel Drive Pin through wheel shaft only for FREE WHEEL position.

Forward Clutch

This control is the two interconnected “paddles” that hang down beneath the control panel. It is used to engage and disengage both the wheels and the tines in forward motion.

To operate the Forward Clutch:

Before engaging the Forward Clutch, first make sure that the Wheel Gear Lever (Econo-Horse and Pony Models only) is in ENGAGE. On the Junior Model, the Wheel Drive Pins must be through the holes in the wheel hubs and the wheel shaft. Then lift up on either or both of the “paddles” and hold it (or them) against the underside of the handlebar grips. As long as you hold the “paddles” in this position, both the wheels and tines will turn.

To stop forward motion of the tines and wheels when you have the Forward Clutch engaged, simply release the “paddles” and allow them to drop downward. Both the wheels and tines will stop rotating—the engine will continue to run.

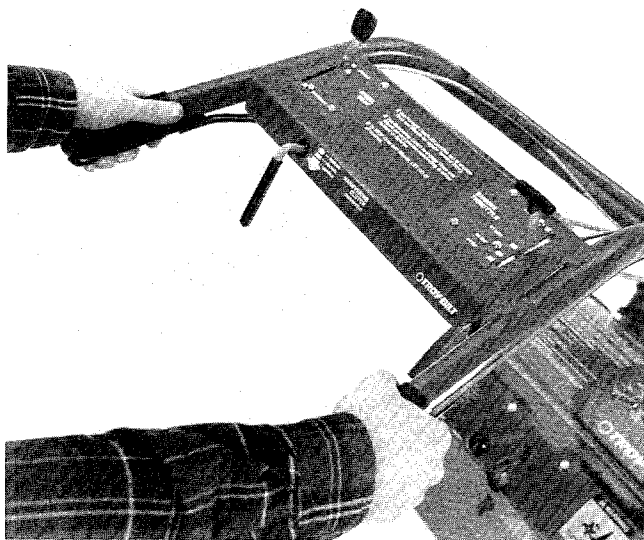

Photo 3-3: The Forward Clutch.

! WARNING

NEVER move the Maneuvering Clutch into either FORWARD or REVERSE unless the Wheel Gear Lever on Econo-Horse and Pony Models is in ENGAGE. On Junior Models, the Wheel Drive Pins must be in WHEEL DRIVE POSITION.

Placing the Maneuvering Clutch in either FORWARD or REVERSE when the wheels are not engaged could allow the tines to rapidly propel the tiller forward or backward.

Failure to follow this warning could result in personal injury or property damage.

Maneuvering Clutch

This control is located at the rear of the left-hand side of the control panel. It is the rod having a 90° bend and a black plastic grip.

The Maneuvering Clutch is used to precisely maneuver the tiller in either a forward or backward direction. Pulling the Maneuvering Clutch out (for REVERSE) or pushing the Maneuvering Clutch in (for FORWARD) engages both the wheels and tines.

If you want to precision till near an obstacle, release the Forward Clutch “paddles” and push in the Maneuvering Clutch Lever. When you want to stop tilling with the Maneuvering Clutch Lever, release it—it will automatically return to NEUTRAL.

If you want to move the tiller forward for a short distance or in close quarters, release the Forward Clutch paddles, lift up on the handlebars until the tines clear the ground. Then push the Maneuvering Clutch in. To stop forward motion, release the Maneuvering Clutch Lever.

The only way you can make the tiller move in reverse is by using the Maneuvering Clutch Lever. Lift up on the handlebars until the tines clear the ground and then pull the Maneuvering Clutch Lever out. The tines and wheels will both move in reverse direction for as long as you hold the Maneuvering Clutch Lever in REVERSE. To stop reverse motion of the tines and wheels, simply release the Maneuvering Clutch Lever.

! WARNING

- When moving the tiller in reverse, always look behind you to check for, and avoid, obstacles.
- Never attempt to till in reverse.

Failure to follow these instructions could result in personal injury.

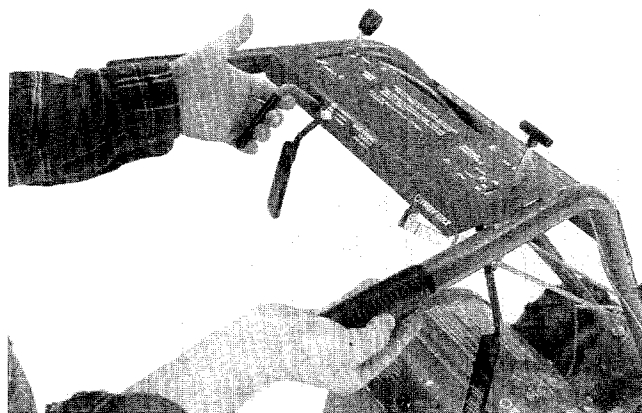

Photo 3-4: The Maneuvering Clutch.

Depth Regulator

The lever at the rear of the tine hood is the Depth Regulator Lever. Pulling back on this lever and moving it either up or down allows you to control the depth of tine penetration in the soil.

When you move the Depth Regulator Lever all the way down (engaging the highest notch on the depth regulator), you put the tiller in the "travel" position. This position allows you to move the tiller without damage to your lawn by allowing the tines to clear the ground by approximately 1-1/2 inches.

When you move the Depth Regulator Lever all the way up (engaging the lowest notch on the depth regulator), you get the deepest tilling depth (approximately six to eight inches, depending on soil conditions).

You should begin tilling at one of the shallower Depth Regulator Lever settings and gradually increase the tilling depth and not attempt to till too deeply too soon.

WARNING

To avoid injury, always place the Depth Regulator Lever in the TRAVEL position before starting the engine. This position prevents the tines from touching the ground until you are ready to begin tilling.

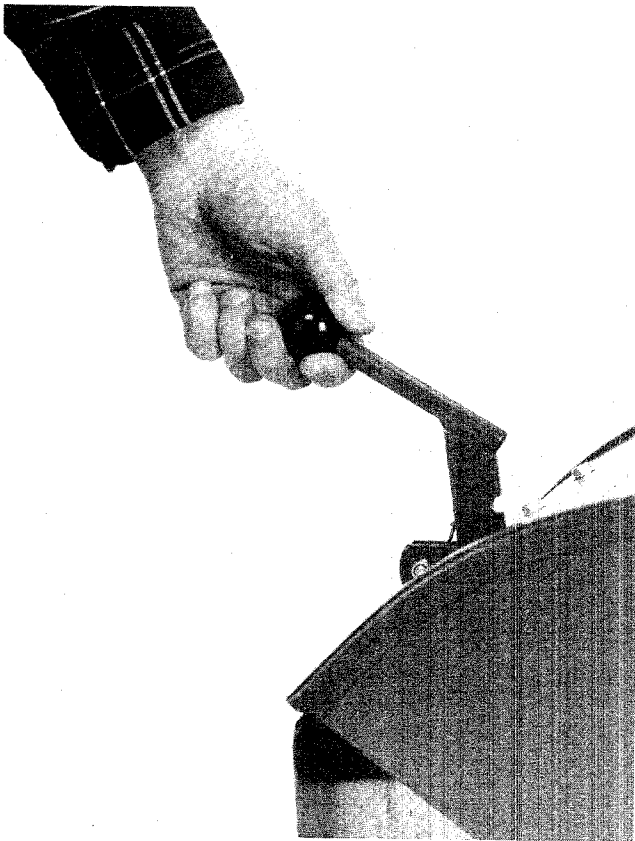

Photo 3-5: The Depth Regulator Lever.

Handlebar Height Adjustment

To adjust the handlebar height:

1. Loosen both bolts at the bottom of the handlebar.
2. Loosen the handlebar height adjustment handle until the keys on the bottom of the keyed washer can clear the slots in the curved handlebar height adjustment bracket.
3. Move the handlebar up or down to the height you desire. Align the hole in the handlebar crossbrace with one of the four slots in the curved handlebar height adjustment bracket.
4. Align the keys on the bottom of the keyed washer with the slot in the curved handlebar height adjustment bracket. Screw the handlebar height adjustment handle into the hole in the handlebar crossbrace. Tighten it securely.
5. Retighten both bolts at bottom of handlebar.
6. Readjust the Forward Clutch mechanism by performing the following steps:
 - a. Remove the inner hairpin cotter from the lower end of the Forward Clutch Rod.

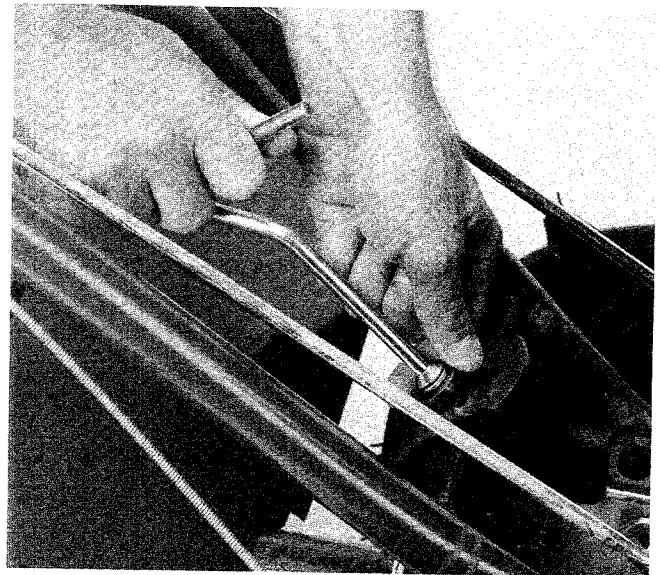

Photo 3-6: Adjusting the Handlebar height.

WARNING

- When you change the handlebar height, you **MUST** readjust the Forward Clutch mechanism.
- When adjusting or checking Forward Clutch mechanism, shut engine off, disconnect spark plug wire and prevent it from touching the spark plug.

Failure to do this could allow the Forward Clutch mechanism to operate improperly, which could result in personal injury or property damage.

b. Use Photo 3-7 to determine which hole in the swivel plate you should insert the lower end of the Forward Clutch Rod into. For example, if you have the handlebar height setting at position number 1 (on the curved handlebar height adjustment bracket) insert the lower end of the Forward Clutch rod into hole number 1 on the swivel plate.

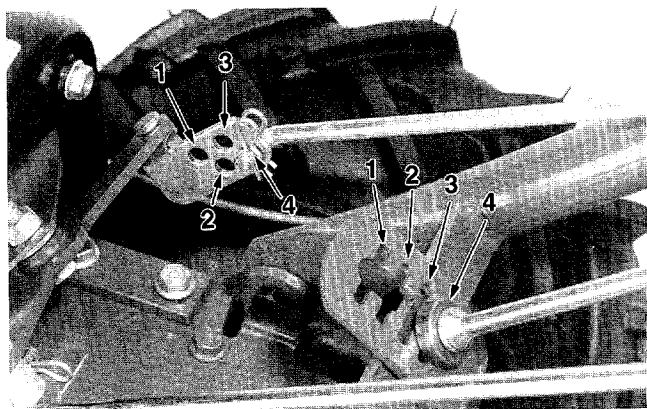

Photo 3-7: Handlebar Height setting and Forward Clutch positioning.

c. Insert the lower end of the Forward Clutch Rod into the proper hole in the swivel plate. Secure it in place by reinstalling the hairpin cotter in the inner hole in the Forward Clutch Rod.

d. To make sure that the amount of tension the Forward Clutch Lever applies is correct:

(1). Stand on the right-hand side of the tiller. Pull the Forward Clutch Lever up and hold it in place.

(2). Check the gap between the E-Ring and the lower end of the bracket on the Forward Clutch Lever. The gap should be $3/16"$ to $5/16"$. If you do not have a ruler handy, five pennies are approximately $5/16"$ thick. Refer to Photo 3-8.

e. If you are unable to get the $3/16"$ to $5/16"$ gap, you'll have to readjust the Forward Clutch Rod as follows:

(1). Pull the Forward Clutch Lever up and hold it in place.

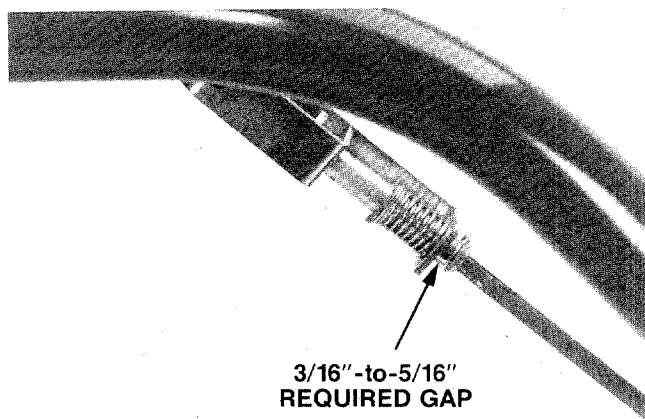

Photo 3-8: Measuring the gap between the Forward Clutch Bracket and the E-Ring.

If the gap is greater than $5/16"$, you'll have to release the Forward Clutch Lever, remove the hairpin cotter from the inner hole in the lower end of the Forward Clutch Rod, move the Forward Clutch Rod away from the swivel plate, and turn the rod counterclockwise (as viewed from the front of the tiller) to decrease the gap.

If the gap is less than $3/16"$, you'll have to release the Forward Clutch Lever, remove the hairpin cotter from the inner hole in the lower end of the Forward Clutch Rod, move the Forward Clutch Rod away from the swivel plate, and turn the rod clockwise (as viewed from the front of the tiller) to increase the gap.

f. After getting the correct gap, make sure that you return the Forward Clutch Rod to the right hole in the swivel plate, then reinstall the hairpin cotter in the inner hole in the lower end of the Forward Clutch Rod.

ENGINE CONTROLS

Please read the following information about engine controls and operation. You should also read the Engine Owner's Manual that you received in your literature package.

Starting Your Engine—Recoil Start and Electric Start Models

1. Check to make sure that the spark plug wire is securely attached to the spark plug.

2. Make sure that the Wheel Gear Lever is in "ENGAGE" on Econo-Horse and Pony Models.

On Junior Models, there is no Wheel Gear Lever, but the Wheel Drive Pins should be through the wheel hubs and wheel shaft holes in "ENGAGE."
3. Move the Depth Regulator Lever all the way DOWN so the tines are in the "travel" position (they should clear the ground by about $1\frac{1}{2}"$).

4. Move the carburetor choke lever to “FULL CHOKE” position on the 4HP Tecumseh engine or the 5HP Briggs & Stratton engine (in the direction of the arrow on 4HP Tecumseh engines; toward “Choke” on 5HP Briggs & Stratton engines). On the 6HP Tecumseh engine, push in the fuel primer button once or twice (providing the engine is cold; otherwise do not prime engine). See Figure 3-9, Photo 3-10 or Photo 3-11.

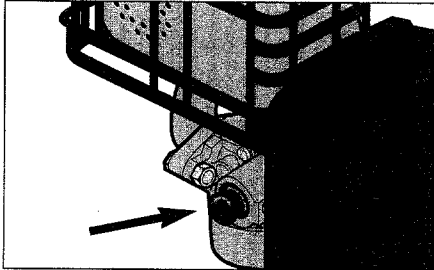

Figure 3-9:
Econo-Horse
Model— fuel
primer button
on the 6HP
Tecumseh
OHV engine.

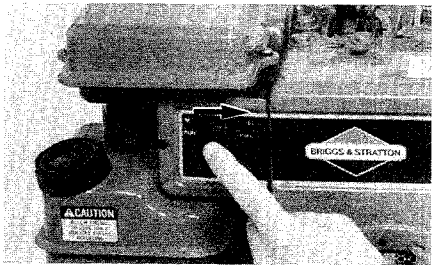

Photo 3-10:
Pony Model—
choke lever de-
sign on the 5HP
Briggs engine.

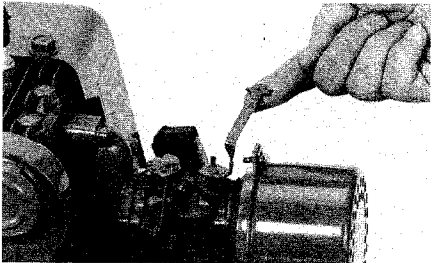

Photo 3-11:
Junior Model—
choke lever
design on the
4HP Tecumseh
engine.

5. Move the Engine Throttle Lever (on the right-hand side of the control panel) to “START.”



Photo 3-12: Engine Throttle Lever.

6. For Standard Start models, grasp the starter rope handle with one hand. Brace the tiller by placing your free hand on the gas tank. Pull the starter rope slowly until you feel resistance. Then pull the starter rope out rapidly...but let it rewind slowly. You may have to repeat this procedure several times until the engine starts. When you pull the rope outward, be sure that nothing is behind you.

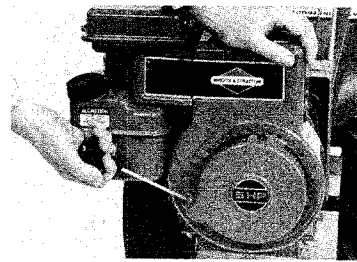

Photo 3-13: Use
starter rope to start
engine.

7. For Electric Start models, turn the Engine Ignition Switch to “START.” Don’t keep the switch in START for longer than ten seconds. You may have to try this several times before the engine starts — allow the engine to come to a complete stop before you turn the switch to START again. When the engine starts, release the key; it will automatically return to “RUN.”

8. After the engine is running, gradually move the Carburetor Choke Lever to NO CHOKE on the Junior 4HP Tecumseh engine or the Pony 5HP Briggs & Stratton engine. There is no choke lever on the Econo-Horse 6HP Tecumseh engine.

Starting the Electric Start Engine with the Recoil Starter Rope

If necessary, the electric start engine can be started with the recoil starter rope. Before doing so, be sure to follow the procedure below.

1. If the battery is in good condition (not “dead” or damaged), keep it on the tiller. This lets it recharge during engine operation. However, before starting the engine with the recoil starter rope, make sure the battery is filled to the UPPER LEVEL line with electrolyte.

2. If the battery is “dead” or damaged, remove it from the tiller and have it tested by a qualified technician. Before using the starter rope to start the engine, disconnect the positive battery cable from the starter solenoid. Reinstall it after replacing the battery.

IMPORTANT—When starting the engine with the starter rope, turn the Ignition Key Switch to RUN. Also move the Engine Throttle Lever to START.

Stopping the Engine

To stop the wheels/tines at any time, simply release the Forward Clutch “paddles” or the Maneuvering Clutch Lever (whichever one you have engaged).

1. To stop the engine on a Standard Start model, move the Engine Throttle Lever to STOP.

2. To stop the engine on an Electric Start model, you can either move the Ignition Key Switch to OFF or you can move the Engine Throttle Lever to STOP.

Section 4:

Operation Of Tiller

Please be sure that you've read, fully understand, and always follow the Safety Instructions (Section 1) and the Tiller and Engine operating instructions (Sections 3 and 4) before you attempt to operate your tiller.

Take a few minutes to familiarize yourself with the basic operation of your tiller before you use it in the garden. Locate a clear, level area and practice engaging the tiller controls and running the tiller back and forth. When you do this, make sure that the tines are in the "travel" position (Depth Regulator Lever pushed all the way down).

Only after you've become completely familiar with your tiller should you begin using it in your garden.

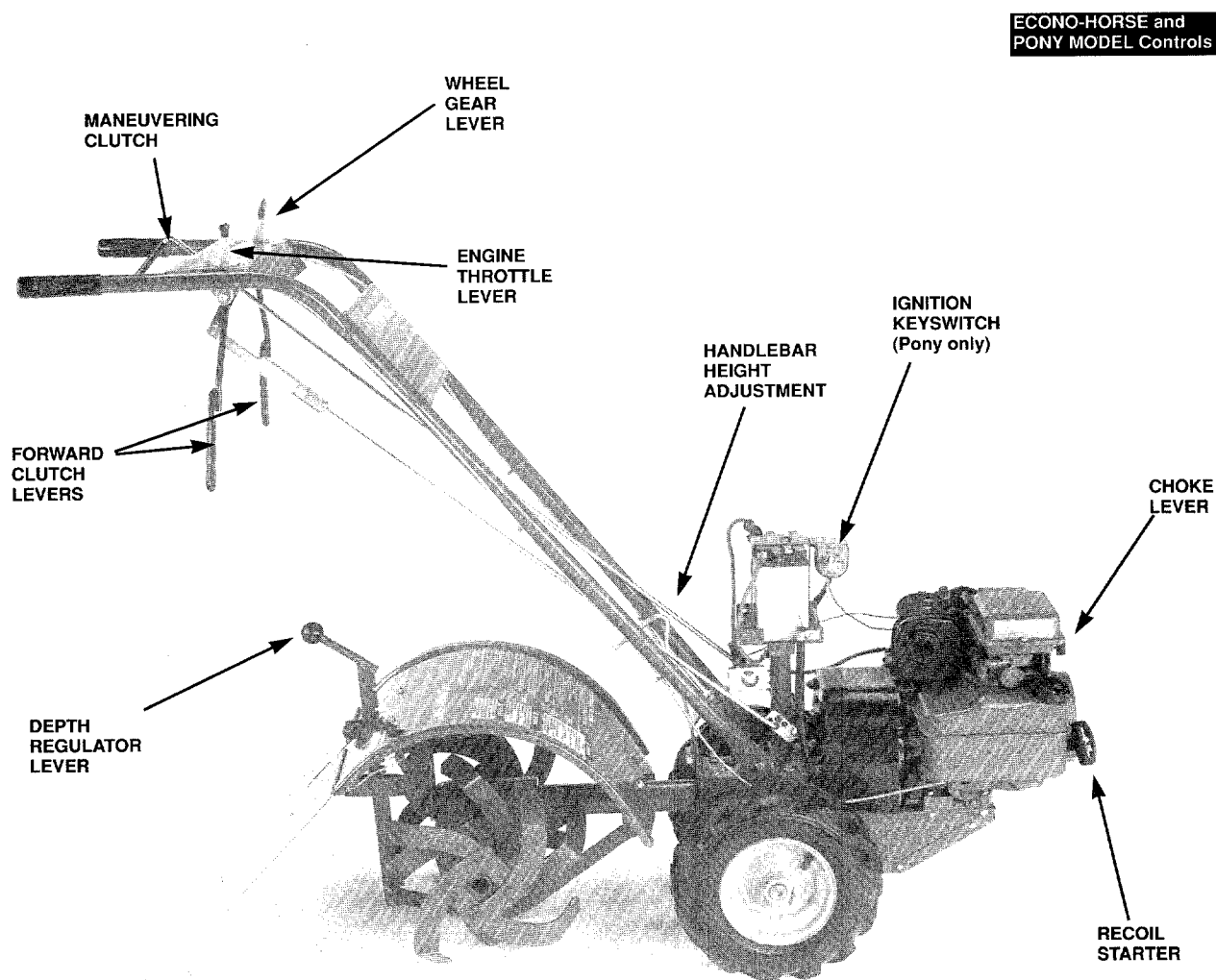

Photo 4-1: Operating your TROY-BILT Rototiller is easy and so rewarding. (Pony Model shown.)

BEFORE STARTING, ALWAYS:

1. Check the engine oil level; add oil as necessary to bring the level up to the FULL mark on the dipstick or to the point of overflowing if your engine has an oil fill tube.
2. Make sure the engine air cleaner element is clean and the air cleaner assembly is tight.
3. Be sure the gas tank has clean, fresh gasoline. The gas tank cap must be screwed on tightly.
4. Check the spark plug wire; make sure that it is securely attached to the spark plug.
5. Put the Wheel Gear Lever (on Econo-Horse and Pony Models) in ENGAGE. On Junior tillers, the Wheel Drive Pins must be ENGAGED through the wheel hubs and the wheel shaft.

TO BEGIN TILLING:

1. Make sure that the Wheel Gear Lever is in ENGAGE on Econo-Horse and Pony Models. On the Junior Model, the Wheel Drive Pins have to be engaged.
2. Move the Depth Regulator Lever to the desired position.

When practicing with your tiller or when moving the tiller to or from the garden, keep the tines in the "travel" position.

When tilling, you must move the Depth Regulator Lever to the desired setting, increase the engine speed, and then begin tilling.

3. Start the engine and allow it to warm up before increasing the engine speed.
4. For forward motion of the wheels/tines, pull the Forward Clutch "paddles" up and hold them up against the handlebars.

If you want to go forward in close quarters, push the Maneuvering Clutch Lever in. The tines/wheels rotate while you hold the lever in.

5. For REVERSE motion of the wheels/tines, lift the rear of the tiller up until its tines clear the ground and then pull the Maneuvering Clutch Lever out. Hold the Maneuvering Clutch Lever out for as long as you need to move in reverse. To stop reverse motion, let go of the Maneuvering Clutch Lever. It will automatically return to NEUTRAL.

TURNING AROUND

Turning your tiller around is fairly easy. You should practice this maneuver before you take your tiller into the garden for the first time. See Photos 4-2 and 4-3.

The key to turning around is remembering that the balance point of your tiller is the wheels. When ready to turn around, lift up on the handlebars to find where the engine and tines are balanced. Then push sideways on the handlebar to move the tiller in the direction of the turn.



Photo 4-2: When you reach the end of a row, slow the engine down and lift up on the handlebars to raise the tines from the soil.

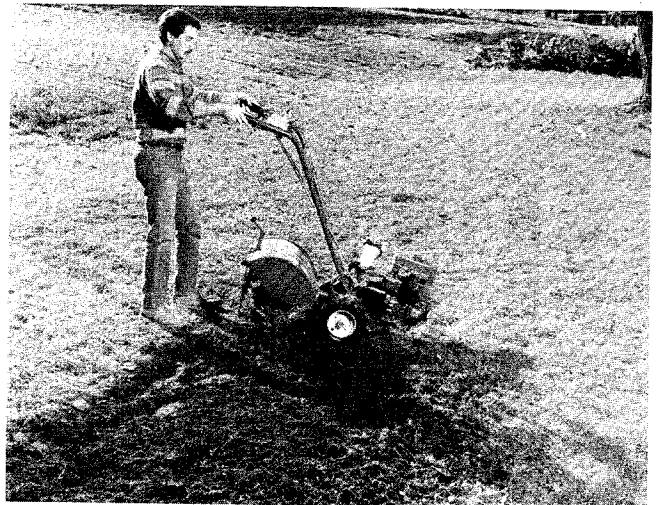

Photo 4-3: Use the wheels as a pivot point to balance the engine and tines. Push the handlebars sideways to move the tiller in the direction of the turn, and continue up the next row.

STOPPING THE TILLER AND ENGINE

1. To stop the wheels/tines, release the Forward Clutch "paddles" or release the Maneuvering Clutch Lever (whichever control you have engaged).

2. If you want to stop the engine, move the Engine Throttle Lever to STOP. If you have an electric start model, you could also turn the Engine Ignition Switch to OFF.

CHANGING SPEEDS (Econo-Horse Model tiller only)

The ECONO-HORSE™ tiller has dual speeds for the wheels and tines. Changing the speed range is just a matter of moving the forward drive belt from one set of grooves in the engine-driven pulley and the transmission pulley to the other set of pulley grooves.

Use the LOW speed belt range for jobs which need more power such as tilling sod and unworked soil; or for tilling under cover crops or extremely heavy weeds. Your ECONO-HORSE tiller is shipped to you with the belt in the LOW range. Keep the belt in this range while you are familiarizing yourself with the operation of the tiller. After you've gained experience with the tiller, then you can experiment with the HIGH speed belt range.

Use the HIGH speed belt range for situations like shallow cultivation, final seedbed preparation, or for power composting heavy leaves, straw, hay, mulch, or composted material. However, if the soil you are tilling this material into is very hard, you may have to return to the LOW speed belt range for better results.

There is a decal on the top of the belt cover that shows the belt positions for the two speeds.

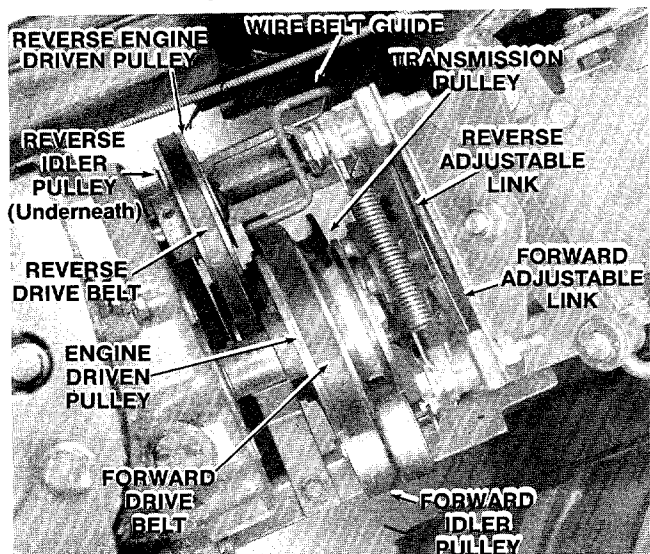

Photo 4-4: Overview of Belts and Pulleys.

! WARNING

Before changing belt speeds, stop the engine, allow the engine to cool, disconnect the spark plug wire and prevent it from touching the spark plug, and remove the Ignition Switch key.

Failure to follow these instructions could result in personal injury or property damage.

To change from LOW Speed to HIGH Speed:

1. Place the Wheel Gear Lever in DISENGAGE (FREE WHEEL).
2. Use a 1/2" wrench to remove the two nuts that secure the belt cover to the tiller.
3. From underneath the tiller, work the forward drive belt into the center groove in the transmission pulley.
4. Push up on the forward drive belt to get slack where the belt goes around the engine-driven pulley.
5. Work the belt into the forward groove on the engine-driven pulley.

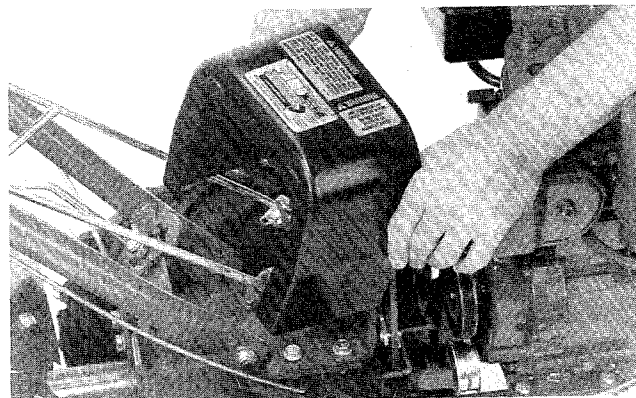

Photo 4-5: Removing Belt Cover.

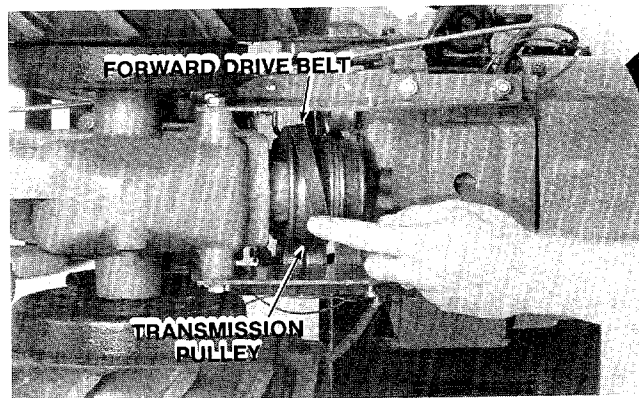

Photo 4-6: Moving Forward Drive Belt into High Speed Groove of Transmission Pulley.

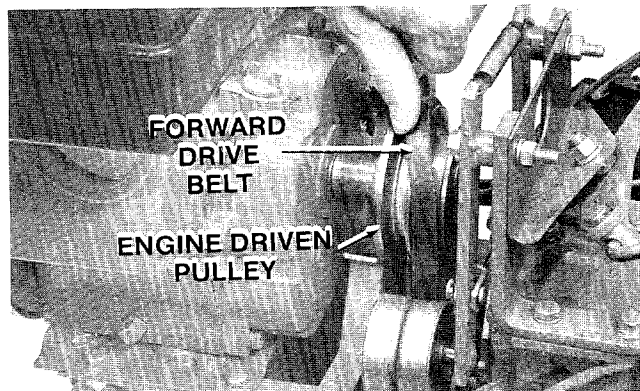

Photo 4-7: Moving Forward Drive Belt into High Speed Position on Engine-Driven Pulley.

NOTE

If the belt only goes part-way into the forward groove of the engine-driven pulley, pull on the start rope to turn the engine-driven pulley to force the belt into the groove.

6. Reinstall the belt cover. Use the 1/2" wrench to securely tighten the nuts.

To change from HIGH speed to LOW speed:

WARNING

Before changing belt speeds, stop the engine, allow the engine to cool, disconnect the spark plug wire and prevent it from touching the spark plug, and remove the Ignition Switch key.

Failure to follow these instructions could result in personal injury or property damage.

1. Move the Wheel Gear Lever to DISENGAGE (FREE WHEEL) .
2. Remove the belt cover by removing the nuts on the back of the cover with a 1/2" wrench. See Photo 4-5.
3. Move the forward drive belt into the rear groove on the engine-driven pulley.

NOTE

If the forward drive belt will not slip all the way into the rear groove on the engine-driven pulley, pull the recoil starter rope while forcing the belt to the rear.

4. From underneath the tiller, work the forward drive belt from the center groove on the transmission pulley to the rear groove.

5. Reinstall the belt cover. Use the 1/2" wrench to securely tighten the nuts.

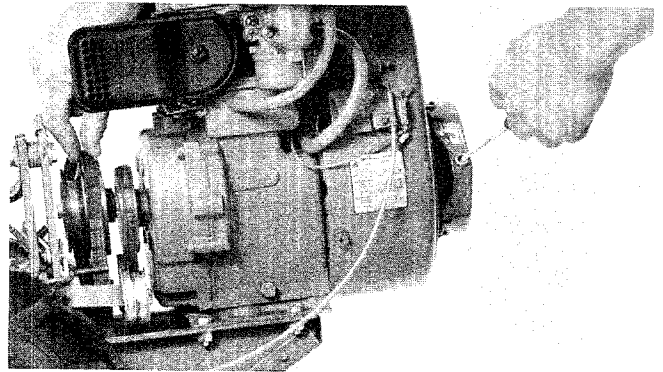

Photo 4-8: Moving Forward Drive Belt into Low Speed Position on Engine-Driven Pulley.

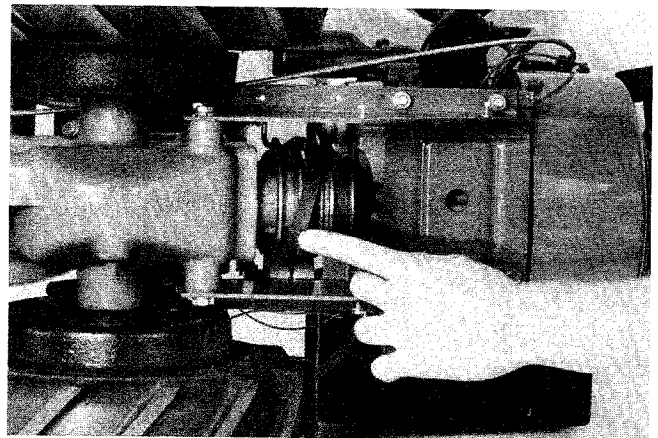

Photo 4-9: Moving Forward Drive Belt into Low Speed Position on the Transmission Pulley.

TILLING IN THE GARDEN

Guiding Your Tiller

While tilling, relax and let the wheels pull the tiller along while the tines do the digging. Walk alongside the tiller on the side that is not yet finished (to avoid making footprints in the just-tilled soil) and lightly, but securely grip the handlebar with one hand.

Please do not push down on the handlebars in an attempt to force the tiller to dig deeper. Doing so takes the weight off the wheels, reduces traction, and causes the tines to attempt to propel the tiller instead of just digging. This can cause the tiller to skip rapidly across the garden.

Sometimes slight downward pressure on the handlebars will help get through a particularly tough section of sod or unbroken ground, but in most cases this won't be necessary at all.

Tilling Depths

When you start to till in the garden, remember to take it easy. Don't try to take too deep a cut in the first pass through sod or hard ground that has not been tilled for years.

It's almost impossible to get down four or five inches on the first pass through untilled soil. In very hard, dry soil, you should start tilling at a very shallow depth regulator setting, only an inch or two deep for the first time. In each succeeding pass, you can go down a few more inches, gradually working down to the depth you want (watering your garden a few days prior to tilling will make the going much easier). At any time, if you have difficulty getting down really deep, let the newly worked soil set for a day or two. When you return to it, the tilling will be easier.

It is best not to work the soil when it is too soggy or wet. Doing so will make too many clumps that won't break up very easily. If time will permit, always wait a day or so after heavy rains for the ground to dry.

In most soils, it's best to start out at the third or fourth notch of the depth regulator to break through the upper inch or two of soil. The fastest method is to till as deep as you can without making the tiller jump when it hits rocks, etc., but you should wait until you are very familiar with the tiller's operation before you use that procedure.

When you are cultivating your garden, the tines should be adjusted to till to a depth of just 1-1/2" to 2" so they won't injure your plants' roots, which grow close to the surface. If you notice the tines are digging too deeply (even when in the highest notch), then you may have to lift up on the handlebars slightly. Also use the high speed belt range (Econo-Horse Model only) when cultivating, as the faster wheel and tine speeds prevent the tiller from digging too deeply.



Photo 4-10: Cultivating.

Tilling Patterns

When preparing a seedbed, go over the same path twice in the first row, then overlap one-half a tiller width on the succeeding passes—see Sketch 4-11. After going up and down the rows in one direction, make a second pass at a right angle across your earlier passes—refer to

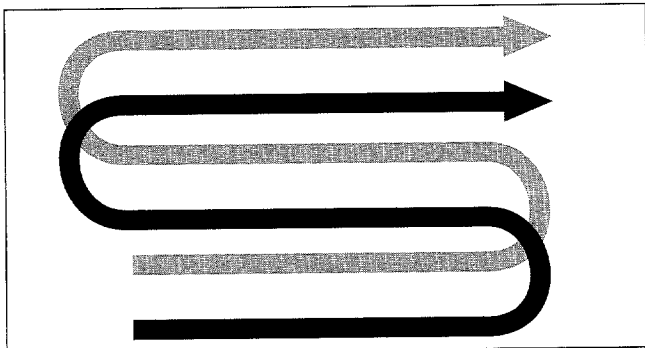

Sketch 4-11: This is the tilling pattern recommended for previously worked soil. Overlap each row one-half a tiller width.

Sketch 4-12. Again, overlap each pass to really pulverize the entire garden area. (In very hard ground, it might take three or four passes before you make much headway.)

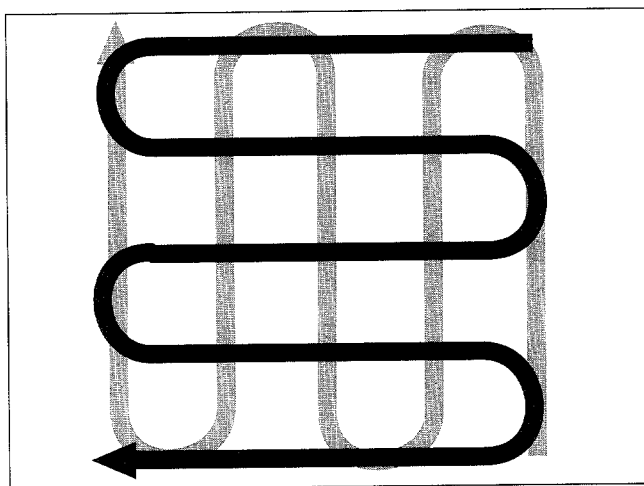

Sketch 4-12: Tilling pattern for unbroken ground.

If your garden is not wide enough to till lengthwise and then crosswise, then you should first overlap by one-half a tiller width, followed by successive passes at one-quarter tiller width. This overlapping method will assure you of thoroughly breaking up the ground—See Sketch 4-13.

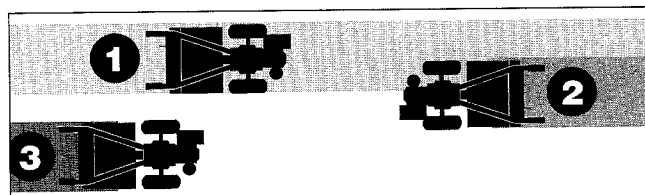

Sketch 4-13: Tilling pattern for narrow strips.

If you plan your garden carefully, you can allow enough room between rows to cultivate, as shown in Sketch 4-14. The Econo-Horse has a tilling width of 18" (the Pony 16", and the Junior 14"), so leave that much distance between the rows, plus enough extra plant growing room above ground. Remember some crops take lots of room—like beans, tomatoes, and peas.

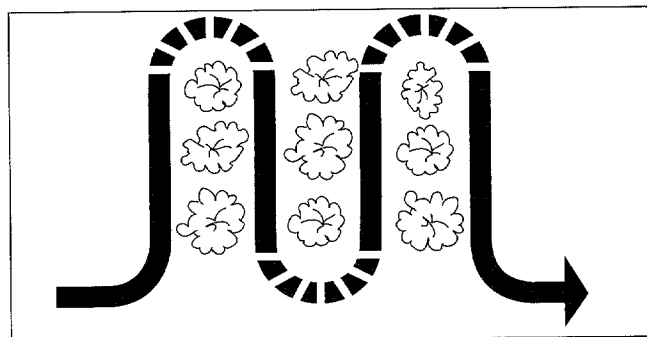

Sketch 4-14: Cultivate between plants to uproot unwanted weeds.

Choosing Wheel and Tine Speeds

With a little experimenting, you can soon find the proper tilling depth, engine throttle setting, and wheel and tine speeds that are just right for the piece of soil on which you are working. What this means is:

1. You advance the throttle lever on the handlebars to keep the engine running at a sufficient power level to do the job. Don't run your engine at full throttle all of the time. Instead, try to judge when the engine is providing the proper amount of power—not too little, but not too much. Matching engine power to the work is easier on the engine and on the tiller. The sound of your engine operating will be your best guide.
2. You have the depth regulator set in a notch which is not so deep that it causes the engine to labor or the tiller to jump.
3. You have the tines turning over fast enough to really break up the soil with a minimum number of passes. Faster engine and wheel speeds may be desirable to break up the last bits of soil or vegetation when you are making final passes, or when you are cultivating.

By the way, try to give your engine a “rest” period during tilling operations by every so often letting it run at low idle for a minute or two—without any load on it. This practice of giving your engine a break while you pick up rocks, prepare to start a new row, or when just pausing for a moment will improve fuel economy and add years to the life of your engine.

When your tiller is working properly, you can hear that the engine is not laboring very hard and see that the tines are breaking up the soil into small, thoroughly tilled bits.

Remember that the wheels have two functions. First they power the tiller in forward or in reverse. Also, they turn much slower than the tines, thus holding the tiller back while the tines dig. Because the separately geared tines revolve much faster than the wheels, they can easily chop up, shred and bury organic material. The tine hood aids in this process as sod, soil and vegetation are thrown up against it by the revolving tines, where it is trapped momentarily before being further broken up and put back in the garden.

Avoid Making Footprints

When making final tilling or cultivating passes, always try to walk alongside the tiller on the side that is not yet finished. If the ground has been well prepared, you can easily walk alongside while guiding your tiller with one hand.

Eliminating footprints contributes much more than just good appearance to your garden. It aids in preventing soil erosion and avoids “planting” unwanted weed seeds right back in your newly tilled ground. It also leaves your soil nice and loose, so that vegetable roots can penetrate it easily.



Photo 4-15: Try to avoid leaving footprints.

Clearing Debris from the Tine Area

Your Bolo Tines have a self-cleaning action which just about eliminates most tangling in the tines. But occasionally, dried out grass, stringy stalks, or tough vines may become tangled. If this happens, lift the tines out of the soil and run your tiller in reverse for a few feet. This reverses the direction of the tines and should unwind a good deal of debris.

It isn't necessary to remove all the residue, but don't let it build up to a point where it chokes off the action of the tines. If reversing the tiller doesn't work, then STOP the machine and engine and remove the tangled material by hand. A small pocket knife or linoleum knife will help you cut away the material.

WARNING

Before unclogging the tines, stop the engine, disconnect the spark plug wire and keep it from touching the spark plug, remove the Engine Ignition key and allow the engine and muffler to cool.

Failure to follow these instructions could result in personal injury or property damage.

Normally, you can avoid most tangling problems by setting the depth regulator deep enough to get maximum “chopping” action as the tines chop the material against the ground, and by tilling under crop residues or cover crops while they are still green, moist and tender.

Also, you might try swaying the handlebars from side to side (about 6" to 12") while continuing to power compost. This “fishtailing” action often clears the debris out of the tines.

Power Composting

It is essential that a garden be fed something if it is to be bountiful year after year in the same location. You must replenish the plant nutrients—primarily nitrogen, phosphorous and potassium—that you took away from the soil in the form of harvested vegetables and fruits. The first place to begin is with crop residues, which include leftover leaves, vines, stems and roots.

Power compost these crop residues directly into your garden soil as soon as they finish bearing. The sooner this is done, the better. Tender green matter not only tills in easier, but provides that much more good food for the earthworms and other beneficial forms of soil life.

Standing cornstalks of reasonable height can be power composted. Pushing over (but not uprooting) tall cornstalks will often make it easier for your tiller to chop up the stalks. Keep the tines clear of excessive tangling by “fishtailing” or frequently using Reverse. Make several passes, then return a few days later to finish off any remaining stubble.

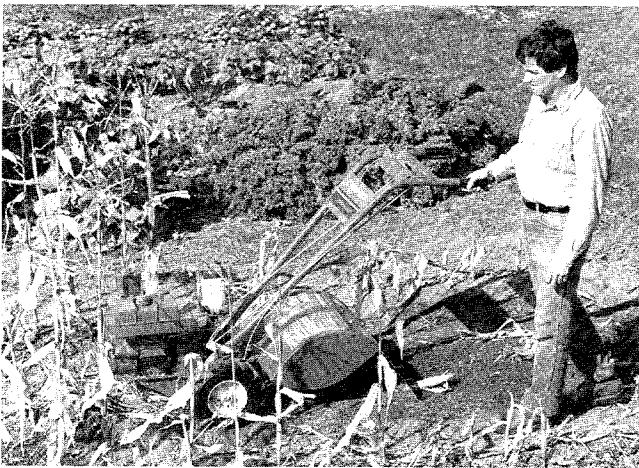

Photo 4-16: Tilling under cornstalks.

After all the crop residues have been tilled under, add more organic matter such as leaves, grass clippings and even kitchen scraps. This organic matter will decompose and add even more important nutrients to the soil to help plants thrive next Spring.

After all the power composting has been done, you should plant a “green manure” cover crop to protect your soil during the off-season. Green manures are also called “cover crops” or “catch crops”. You simply grow a crop of clover, alfalfa, buckwheat, peas, beans, rye grass, grain, or kale and then later till it into the soil, thus adding far more nutrients than you have taken out.

Using Reverse To Help Turn Around in Tight Areas

Using your tiller near obstacles like fences, stone walls, sheds or trees needn't be a problem if you use Reverse to help you maneuver the tiller around and away from the obstacles. For example, turning around at the end of a row in the garden that's very near a fence is easy. When at the end of a row, you can go right up near the obstacle, then engage the tiller in Reverse while holding the handlebars up and turning the tiller at the same time. Alternating briefly between going Forward and then in Reverse will let you complete your turn in a very small area.



Photo 4-17: To turn around in cramped quarters, move close to obstacle, then put the tiller in Reverse while lifting up on the handlebars (to raise the tines out of the soil) and turning the tiller.

Tilling Near Obstacles Requires Caution

Always be sure to avoid coming too close to any obstacles (fences, rock walls, posts, buildings, etc.) that could be damaged by your tiller, or that could cause damage to your tiller. Whenever possible, stay away from objects such as this. Tilling another few inches closer to an obstacle just isn't worth the property damage that could occur unexpectedly.

AVOID AREAS THAT MAY HAVE UNDERGROUND CABLES, WIRES OR GAS LINES!

Before you do any tilling with your tiller, please find out if there are any cables, electric lines or gas lines that might have been installed underground by a local utility company or by a previous owner of your property. If there are any lines, avoid tilling near them. This is an **IMPORTANT SAFETY PRECAUTION** that should be investigated fully until you know that you're tilling in a safe area.

⚠ WARNING

BEFORE TILLING, CONTACT YOUR TELEPHONE OR UTILITY COMPANY IF UNDERGROUND EQUIPMENT OR LINES ARE USED IN YOUR AREA. Their representative will be glad to answer your questions and tell you if any of their equipment or lines are buried underground on your property.

Tilling Up and Down Slopes

If you must garden on a moderate slope, then the best way to do so is by planting rows up and down the slope. Tilling vertically in this manner permits you to use the entire area for your seedbed as well as to provide enough room between rows so that you can cultivate between them during the growing season (you lose these valuable benefits when you terrace garden, which is discussed next).



Photo 4-18: Tilling up a slope.

Gardening vertically does not involve much of a soil erosion problem, as long as you put in enough organic material to improve the moisture-holding ability of your soil, and if you avoid leaving footprints and wheel marks. Soil in this condition is loose enough to prevent packing, and is held together well enough by those organic materials so that it readily absorbs water.

Whenever you are tilling vertically on the slightest slope, try to make your first pass uphill. Your tiller digs in much more deeply going uphill than it does downhill. The powered wheels of your tiller pull the machine up the hill to do your digging and also hold the tiller back while you go downhill to prevent the tiller from going too fast. In soft soil or weeds, you may have to lift the handlebars up slightly as you go uphill. When going back down the slope, overlap your first pass by about half the width of the tiller.

Tilling Across Slopes with Terraces

Whenever a slope is too steep or too short for vertical tilling, it may be necessary to till across the slope laterally. The best way to achieve good results tilling across the slope is to create terraces for your garden.

Terraces should be about two to three feet wide. This means you'll be able to plant one or two rows of plants and till under crop residues and cover crops, but there may not be enough room for cultivating with your tiller. (If you make terraces too wide, you would be digging as much as a foot into the uphill side of the terrace and you would end up trying to grow vegetables in the poor subsoil there.)

First, make sure that the slope is not too steep to till safely. Then start to terrace on the top of the slope and work down. In three or four passes, your tiller can carve out a flat and wide enough terrace for planting, as shown in Sketch 4-19. Each succeeding lower terrace is started by walking below the terrace you're preparing.

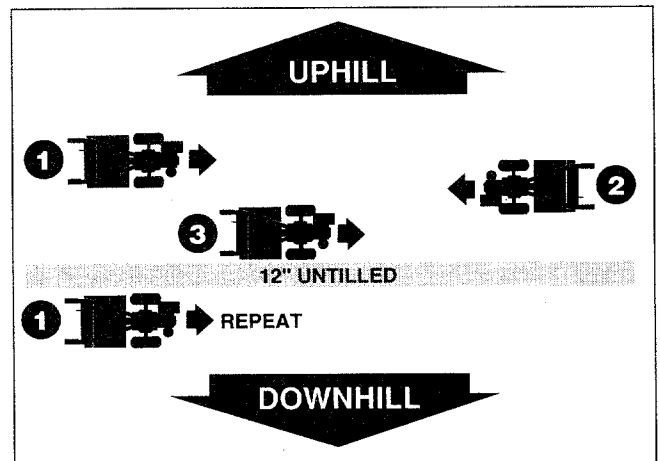

Sketch 4-19: Creating a terrace in just three tilling passes.

Make sure that you don't till the last 12" or more of the downhill outside edge of each terrace—See Photo 4-20. Keeping the soil unbroken beneath the outside edge will help to prevent terraces from breaking apart and washing downhill. It also gives you a walking path between the terraces.



Photo 4-20: Leave the outside edge (12" or more) unbroken to prevent erosion.

Tilling Across Slopes Without Terraces

If terracing isn't practical for you, then you can till laterally across a slope, although we don't really recommend it. For best results, we urge you to till vertically up and down a slope, or create terraces.

First, make sure that the slope is not too steep to till safely. Then, begin at the top of the slope and overlap half of each tilled path, always keeping the uphill wheel in the soft, newly tilled soil. Doing so will help keep the tiller more stable across a relatively steep slope.

UPHILL TILLING NOTE

When tilling on slopes, be extra careful to see that your engine crankcase is kept filled to either the **FULL** mark on the dipstick (6HP Tecumseh engines) or to the top of the engine oil fill tube (5HP Briggs and 4HP Tecumseh engines).

When tilling at the deepest settings and going up a steep hill, the oil slants away from its normal level and can starve the engine of lubrication as the engine's oil dipper may not be able to reach the oil due to its slanted level. Keeping the oil level at the **FULL** mark is very important for the protection of your engine.

To prevent engine damage from oil starvation, check engine oil level at least every half-hour during uphill tilling operations.

LOADING AND UNLOADING TILLER

WARNING

Loading and unloading your tiller into a vehicle is potentially hazardous and we don't recommend that you do so unless absolutely necessary, as this could result in personal injury or property damage.

However, if you must load or unload the tiller, follow the guidelines given next.

- Shut the tiller engine off before loading or unloading. Allow the tiller engine to cool, disconnect the spark plug wire and prevent it from touching the spark plug. (Remove the Ignition Switch key on electric start models.)
- The tiller is too heavy (well over 200 pounds) and bulky to lift safely by one person. To lift the tiller, two or more people should share the load.
- We recommend that you use sturdy ramps and that you manually (engine shut off) roll the tiller into and out of the vehicle. This will require assistance from another person.
- Ramps should be strong enough to support the tiller and the handlers. The ramps should provide good traction to prevent slipping; they should have side rails to guide the tiller up and down the ramps; and they should have a locking device to secure them to the vehicle bed.

- The operator and handlers should wear sturdy footwear that will help to prevent slips.
- Position the vehicle so the ramp angle is as flat as possible (the less the incline of the ramp, the better). Turn the vehicle's engine off and apply the vehicle's parking brake.
- When going up ramps, stand in the normal operating position and push the tiller ahead of you. Have a person at each wheel to turn the wheels.
- When going down ramps, walk backward down the ramp with the tiller following you. Keep alert for, and avoid any obstacles that could cause you to fall. Position a person at each wheel to control the speed of the tiller. Never go down ramps tiller-first, as the tiller could tip forward.
- Have wooden blocks handy to place on the downhill side of the wheels if you need to stop the tiller from rolling down the ramp when unloading or loading. Use the blocks to temporarily keep the tiller in place on the ramps while you get a firmer grip on the handlebars, reposition the tiller, etc. Also use the blocks to chock the wheels in place after you've tied the tiller down.
- Once the tiller is in the vehicle, move the Wheel Gear Lever to "ENGAGE" (on Econo-Horse and Pony Models) or be sure the Wheel Drive Pins are Engaged (Junior Model). This locks the wheels in position and helps prevent the tiller from moving. Then securely tie the tiller down.

Section 5:

Tiller And Engine Maintenance

There are a few very important steps that you can perform in order to get the best performance and longest life from your tiller. These steps are: frequent engine oil changing, frequent air cleaner element cleaning and replacing, keeping the engine cooling fins clean, lubricating the tiller regularly, and keeping the belts adjusted properly.

You will be operating your tiller in a very dusty environment, often for extended time periods at high temperatures. Proper maintenance is therefore very important.

WARNING

Before performing any maintenance on your tiller, stop the engine, allow it to cool, disconnect the spark plug wire and prevent it from touching the spark plug, then remove the Engine Ignition key.

Failure to follow this instruction could result in personal injury or property damage.

LUBRICATION

Proper lubrication is an essential part of your maintenance program. By oiling or greasing the lubrication points shown in Photos 5-1 and 5-2 at regular intervals, you will be sure of the best performance from your tiller. Use ordinary clean engine motor oil (30 weight) where oil is called for. Use a good quality grease that has a metal lubricant added when possible; however, regular grease is acceptable.

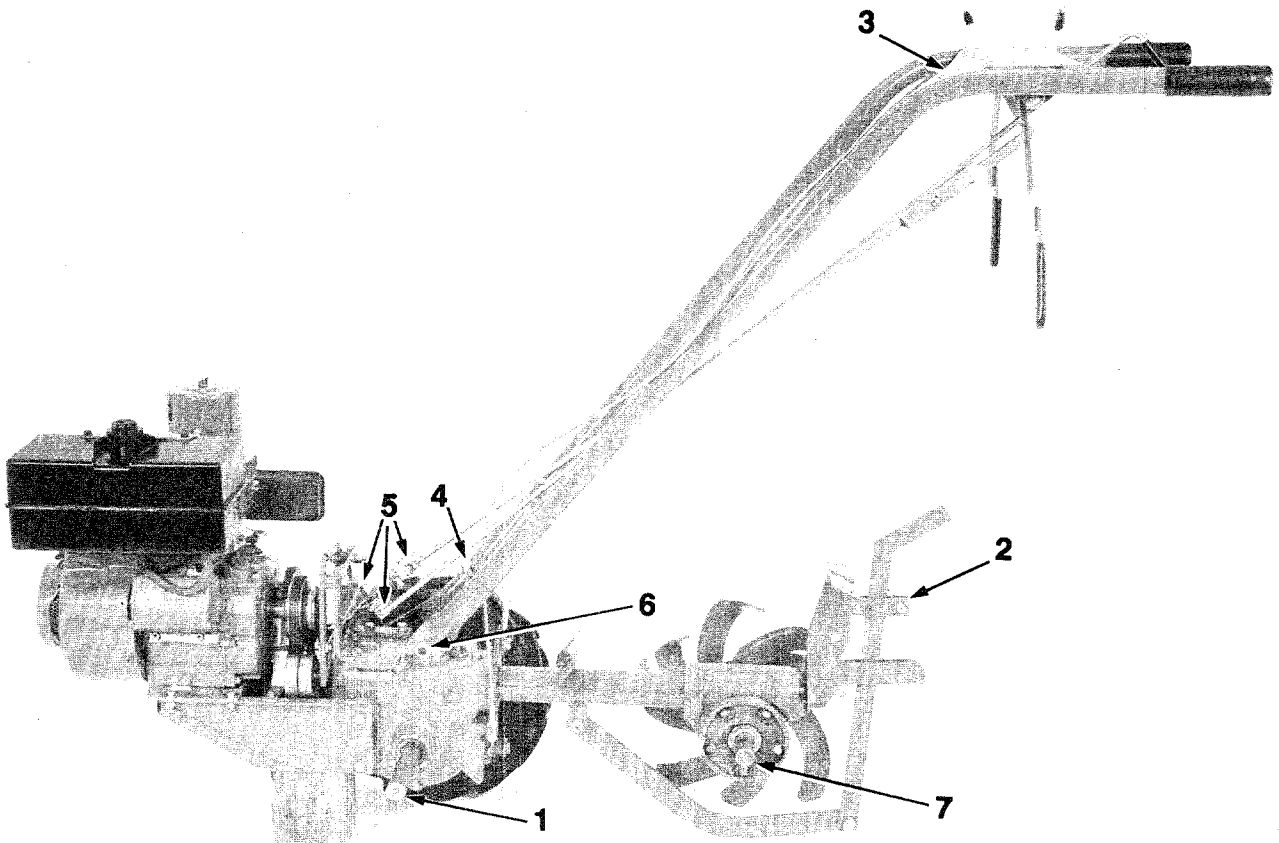

Photo 5-1: Lubrication points common to the Econo-Horse, Pony, and Junior Model tillers.

1. Remove one wheel, clean the wheel shaft, and apply a thin coat of grease. Repeat at the other end of the wheel shaft.
2. Grease the back, front, and sides of the Depth Regulator Lever.
3. Oil the entire length of the Engine Throttle cable (all models) and the Wheel Gear cable (except Junior Model.) Just apply oil to the outside of the cables, allow it to work its way inside, and wipe off the excess oil.
4. Oil the threads on the Handlebar Height Adjustment Handle.
5. Oil the pivot points on the shifting mechanism.
6. Oil the handlebar pivot points.
7. Clean and grease the tine shaft on both sides of the tiller. Inspect the tine shaft for rust, rough spots, or burrs; especially near the holes. File or sand any rust, rough spots, or burrs smooth and then coat the tine shaft ends with grease to make future removal easier.
8. Carefully oil the idler arm pivot points. Be careful not to spill any oil on the belts or pulleys.

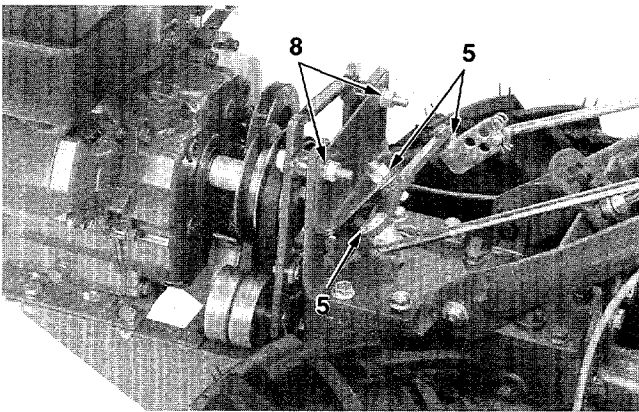

Photo 5-2: Lubrication points on the shifting mechanism.

CHECK FOR OIL LEAKS

You should regularly check your tiller for oil leaks, both from the transmission and from the engine. Look for signs of an oil leak by looking for a dirty, oily accumulation on the transmission and engine. Also look on the floor where you've been parking the tiller.

A little seepage around a gasket or oil seal is not a cause for alarm. However, if oil drips while the tiller is sitting overnight, then you should replace the worn oil seal or gasket right away—first try tightening any loose screws or bolts.

If your tiller leaks a fair amount of oil, you should not run it until you have replaced the gasket or oil seal. Ignoring leakage can cause expensive damage to the transmission or engine.

If you have problems with a tiller leak, please call or write our Technical Service Department here at the factory.

TIGHTENING NUTS AND BOLTS

WARNING

Before inspecting or servicing the tiller, stop the engine, disconnect the spark plug wire and keep it from touching the spark plug, remove the Engine Ignition key and allow the engine and muffler to cool.

Failure to follow these instructions could result in personal injury or property damage.

It's a very good idea to periodically check all nuts, bolts, and screws on your tiller for tightness. Loose nuts, bolts, or screws can lead to equipment failure, poor performance, or oil leaks. Most nuts, bolts, and screws on your tiller are easily visible.

There are also three end cap screws on the rear end of your tiller's transmission that should be inspected for tightness. Gently tilt the tiller forward on its engine and support it in this position. Lift the rear flap and tighten the screws.

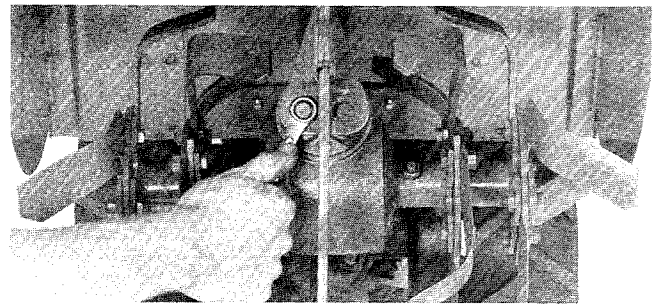

Photo 5-3: Tightening end cap screws.

ADDING, CHECKING, OR CHANGING TRANSMISSION GEAR OIL

Every 30 hours of tiller operation you should check the transmission oil level. Also check the transmission oil level if you notice any oil seepage. If you allow the tiller transmission to run low on oil, increased heat buildup could cause expensive damage to the transmission.

To check the transmission gear oil level:

1. Make sure that the tiller is parked on a level area. Place the Depth Regulator Lever in the second notch. This is its most level position.
2. Use a 3/8" open end wrench to loosen the transmission oil check plug (above the left wheel axle, on the side of the transmission case).
3. If the transmission oil level is correct, oil should just begin to flow out of the check hole.

NOTE: Make this check when the transmission is not hot. If hot, the gear oil has expanded and might give an incorrect reading.

To top off the gear oil level in the transmission:

1. Follow steps 1 and 2 of "To Check the Transmission Gear Oil Level" covered previously.
2. Unscrew the transmission oil filler cap (on top of the transmission).
3. Use a funnel and pour either SAE 140, SAE 85W-140, or SAE 80W-90 weight gear oil with an API rating of GL-4 or GL-5 into the transmission. Don't use multi-viscosity gear oil, automatic transmission fluid, or engine oil in the transmission. They are too light for transmission use. They will cause transmission leaks and won't protect its parts.
4. Stop pouring gear oil when it begins to flow out from the transmission oil check hole.
5. Reinstall the transmission oil check hole plug and tighten it securely with the 3/8" wrench.

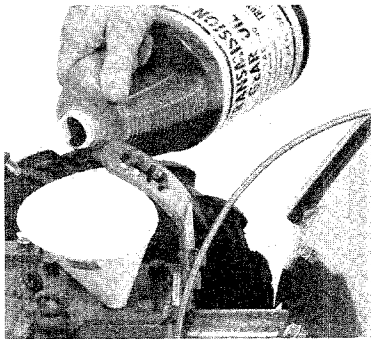

Photo 5-4: Adding gear oil to transmission. Stop when oil exits from check hole at the side.

6. Reinstall the transmission oil fill hole plug. Securely tighten it by hand.

To drain and refill the transmission:

The transmission gear oil does not have to be changed unless you know that it has been contaminated with dirt, sand or metal particles.

You will have to drain the transmission gear oil if you are making repairs to the transmission.

1. Place a prop underneath the tiller so that it will be supported when you remove the left-hand wheel.
2. Remove the hardware securing the wheel to the wheel shaft from the left-hand wheel. Slide the wheel pin out of the holes in the wheel.

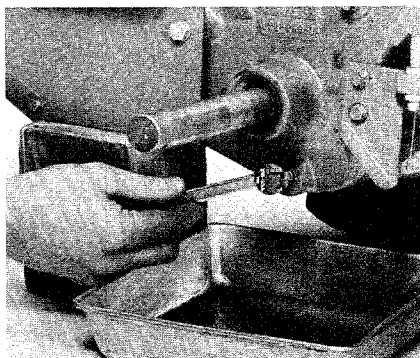

Photo 5-5: Draining Gear Oil from Transmission.

Remove the wheel.

3. Position a shallow pan underneath the transmission gear oil drain plug.
4. Unscrew the transmission gear oil fill plug from atop the transmission.
5. Use your 3/8" open end

wrench to take out the transmission gear oil drain plug from the left-hand side of the transmission (beneath the left-hand axle shaft). Then remove the transmission gear oil check hole plug (on the left-hand side of the transmission above the wheel axle shaft).

6. Allow all transmission oil to drain into the pan.
7. When the oil stops flowing, tilt the tiller forward so oil will drain from the rear of the transmission.
8. After all the gear oil has drained, clean the threads of the transmission drain plug, apply a non-hardening gasket sealant to the plug's threads and reinstall the plug. Securely tighten it.
9. Insert a clean funnel in the transmission oil fill hole. Slowly pour SAE 140 or SAE 85W-140 weight gear oil with an API rating of GL-4 only into the transmission. The transmission holds approximately 3-1/4 pints (52-54 ounces). Slightly tilt the tiller backwards to make sure the rear end of the transmission gets filled with gear oil. When gear oil begins to flow from the transmission gear oil check hole, the transmission is full.
10. Reinstall the transmission gear oil check hole plug. Securely tighten it with the 3/8" wrench.
11. Reinstall the transmission gear oil fill hole plug. Tighten it securely by hand.
12. Reinstall the left-hand wheel. Remove prop.

CHECKING ENGINE OIL LEVEL

Keeping the engine oil level correct is very important. Running your engine when it is low on oil is an invitation to expensive engine damage.

Check the engine oil level before using the tiller. Also check it every five hours of operation. If you are working in very dusty conditions, check the oil level more frequently and change the oil more often than the recommended intervals.

To check the engine oil level:

1. Move the tiller to a level area.
2. Move the Depth Regulator Lever to the second notch (from the top). This puts the engine in a level position.
3. Clean the area around either the engine dipstick or oil fill tube so no debris will fall into the engine. If your engine has a fill tube, take off its cap—the oil should be up to the top of the tube. Add oil if needed, then replace the cap. If your engine has a dipstick, remove it, wipe it clean, and follow steps 4 through 6 next.
4. Screw the dipstick into the engine all the way. Then tighten it finger-tight.
5. Unscrew dipstick. The oil level should be between FULL and ADD marks on the dipstick. Add proper specification motor oil (see pages 48-49 or engine literature for motor oil specs) to bring level to FULL mark. Do not overfill.

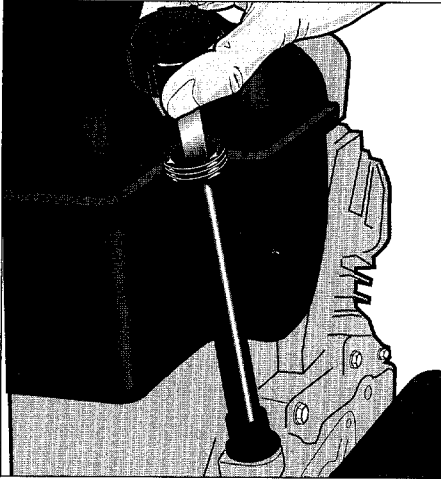

Figure 5-6: Checking the engine oil level on the 6HP Tecumseh engine on the Econo-Horse tiller.

6. After checking the oil level, reinstall the dipstick. Tighten it securely.

CHANGING ENGINE OIL

Clean, fresh engine oil is essential for best performance and longer engine life. You should change the engine oil after the first two (2) hours of engine operation. After this initial oil change, change the oil every ten (10) hours of operation.

If operating under very dusty or dirty conditions, change engine oil more frequently.

Always use oil that is classified SF, SG, SH, or SH/CD. Use SAE30 weight oil when temperature is above 32°F (Tecumseh engines) or 40°F (Briggs & Stratton engines). Do not use SAE 10W40. For complete motor oil specifications for your engine, refer to Pages 48-49 or the separate engine manufacturer literature sent to you.

The engine oil capacity depends on the model tiller you have. Refer to the engine manufacturer literature supplied to you for all engine oil capacity specifications.

To change the engine oil:

1. Run the engine until it is warm and then shut it off. Warm oil drains more easily and also carries more of the contaminants away.
2. Note the drain plug which may be located on either side of the engine base.

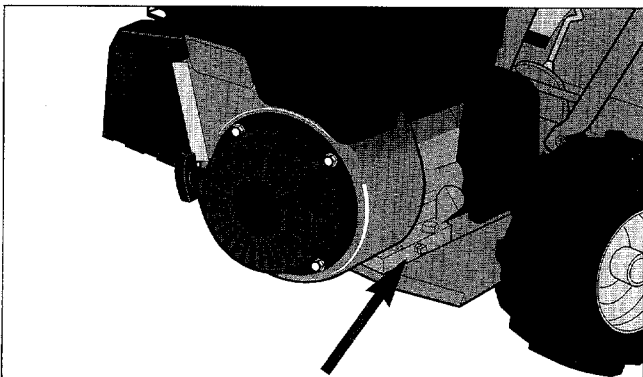

Figure 5-7: Remove drain plug to drain engine oil.

3. Place a board beneath the wheel *opposite* the drain plug you'll be removing.
4. Place a pan beneath the drain plug.
5. Use a 3/8" open end wrench to remove the drain plug. Let the oil drain into the pan.
6. Clean the drain plug's threads and reinstall it. Be sure to tighten the drain plug very securely.
7. Refill the engine crankcase with fresh oil.
8. Check the engine oil level carefully. Depending upon the engine you have, use either the dipstick or inspect the level in the oil fill tube.

AIR CLEANER SERVICE

Your engine is equipped with an air cleaner whose purpose is to filter the air before it enters the carburetor. Frequent air cleaner service is essential for performance and long engine life.

The Econo-Horse and Pony have dual element air cleaners. The Junior has a single element air cleaner. All differ in service requirements as noted:

Econo-Horse (see Figure 5-8). On this horizontal-style cleaner, clean and re-oil the outer foam element every 25 hours; replace the inner paper filter every 100 hours or annually if 100 hours is not reached.

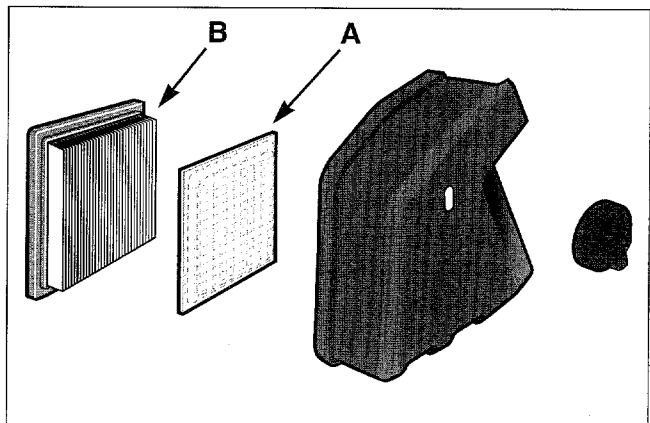

Figure 5-8: Econo-Horse dual-element air cleaner— an outer foam filter (A) and an inner paper filter (B).

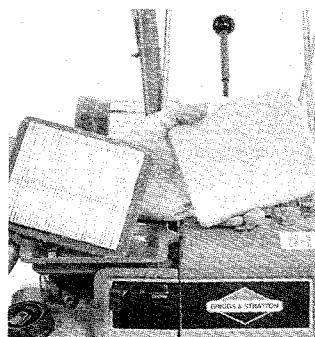

Photo 5-9A: Pony dual element air cleaner.

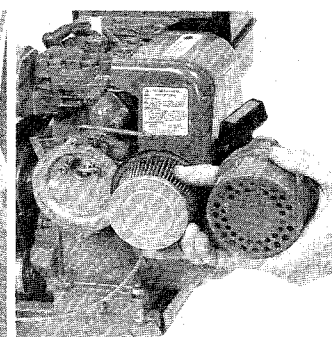

Photo 5-9B: Junior single-stage air cleaner.

Pony (see Photo 5-9A)—clean (do not oil!) the outer foam element every 10 hours; clean the inner paper filter every 10 hours too, and replace it every 50 hours.

Junior (see Photo 5-9B)—replace the single paper filter element after every 25 hours of engine operation. Do not clean it or oil it.

General Guidelines for servicing all model air cleaner systems:

- Before removing the outer air cleaner cover, always remove any dirt or grease in the immediate vicinity—do not get dirt or grease or any foreign materials in the carburetor!
- Inspect the foam pre-cleaner (if your model comes with one) and the paper filter for signs of excessive wear, tearing, or a loose fit.
- Wash the foam pre-cleaner only in a warm water / liquid detergent mixture. Do not use kerosene or mineral spirits as they could damage the foam. Then rinse it in clear water and squeeze until it is dry (don't wring it out). The Tecumseh 6HP foam pre-cleaner should be oiled. The Briggs & Stratton 5HP foam pre-cleaner should not be oiled. (The Junior Model's Tecumseh engine does not have a foam pre-cleaner.)
- Wipe the inside of the air cleaner cover and the top of the air cleaner base plate with a clean rag to remove dirt and grime. Don't knock dirt in the carburetor!
- Carefully install the foam pre-cleaner and paper filter inner element, and the outer cover with its hardware. The fit of these parts must be secure and correct. All parts must be reassembled as per the original assembly. The performance of your engine is dependent upon this.

NOTE—In very dusty or dirty conditions, inspect and clean the filter(s) more often.

SPARK PLUG MAINTENANCE

NOTE: Before you remove the spark plug, brush or blow away debris from the top of the cylinder head. This prevents debris from accidentally falling into the spark plug hole.

Every fifty (50) hours of operation, remove the spark plug and replace or clean it. If cleaning, only scrape it—do not sandblast or wire brush it. Reset the gap to .030". See engine literature.

IGNITION SYSTEM MAINTENANCE

Your tiller's engine is equipped with electronic ignition. It does not have either a condenser or points. Therefore, you do not have to perform any regular maintenance on this system other than checking, cleaning, and adjusting (or replacing) the spark plug as mentioned previously.

AIR COOLING SYSTEM MAINTENANCE

Since your tiller operates in such a dusty environment, you should frequently check the engine's cooling system for any type of obstruction. Look between the engine cooling fins and the engine air shrouds, and under the blower housing for any trapped debris.

After the engine has cooled, use a screwdriver or other tool to remove any trapped debris. Do not remove the blower housing unless it is absolutely necessary.

WARNING

Failure to keep your engine's cooling system clean will cause engine overheating and will lead to engine damage.

BOLO TINES

Your tiller has bolo tines to more effectively shred, chop, and bury the organic matter that you are tilling back into your garden soil.

With use, these tines will become shorter, narrower, and pointed. When badly worn, they won't be able to turn over as much earth as new tines.

Compare your tines with those in Photo 5-10 if you should notice a loss of tilling depth or poor power composting. If your tines have become too worn, you should replace them.

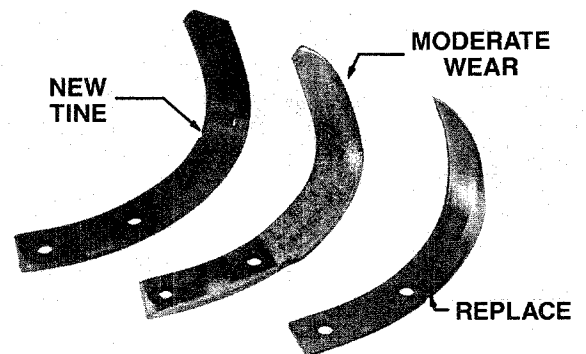

Photo 5-10: Checking Bolo Tines for wear.

Removing the Bolo Tine Assembly

WARNING

Stop the engine, allow it to cool, disconnect the spark plug wire and prevent it from touching the spark plug, then remove the Engine Ignition key before performing any maintenance on your tiller.

Failure to follow these instructions could result in personal injury or property damage.

1. Use a 3/8" wrench to remove the two rear bolts that hold the hood to the rear hood support.
2. Use a 7/16" wrench to remove the two forward bolts that hold the hood to the front hood support. Remove the hood.
3. Remove the bolt and locknut that secure the tine assembly to the tine shaft. See Photo 5-11.

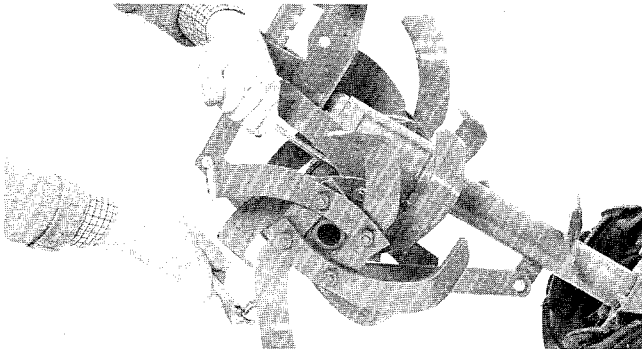

Photo 5-11: Removing the Bolo Tine assembly. The Econo-Horse model is shown. The Pony and Junior tine assemblies remove similarly.

4. Use a rubber mallet to tap the tine assembly outward to loosen it from the tine shaft.
5. Slide the tine assembly off the tine shaft.
6. Repeat steps 3, 4, and 5 for the other tine assembly.

Removing Individual Bolo Tines

You can either remove the bolo tine assembly and then remove individual tines from the assembly, or you can remove individual bolo tines from the tine assembly while it's still mounted on the tine shaft.

WARNING

Stop the engine, allow it to cool, disconnect the spark plug wire and prevent it from touching the spark plug, then remove the Engine Ignition key before performing any maintenance on your tiller.

Failure to follow these instructions could result in personal injury or property damage.

Use two 9/16" wrenches to remove both bolts that hold an individual tine to the tine holder.

NOTE: You may have to use penetrating oil on the nut to loosen it. Remember to always turn the nut, not the bolt head.

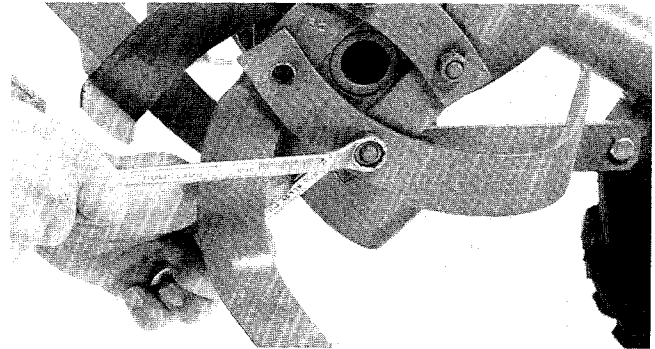

Photo 5-12: Removing an Individual Bolo Tine. Follow same procedure for all models.

CHECKING DRIVE BELT TENSION

On a new tiller (or if you've installed a new belt on an older tiller), you'll have to check and probably adjust the tension on the forward drive belt after the first two (2) hours of operation. This is due to the new belt seating in place.

The reverse drive belt, because it is used more sparingly, will probably not require an initial tension adjustment until a significant number of operating hours has passed.

After this initial adjustment, check the belts' tension every ten (10) hours of operation.

Maintaining the correct tension on the drive belts is important to good tilling performance and long belt life. If a belt is too loose, it will slip on the engine and transmission pulleys. This will cause the tines and wheels to slow down—or stop completely—even though the engine is running at full speed.

A loose belt will also result in uneven wear and overheating of the belt sidewalls. This reduces its driving capability and shortens its life.

When checking the belts for proper tension, also look for obvious signs of wear such as cracks, cuts, or fraying. If a belt is in poor condition, it should be replaced immediately.

WARNING

Follow the belt adjustment instructions carefully. An incorrect adjustment could result in the Forward Clutch mechanism engaging too soon.

This could result in loss of tiller control and personal injury or property damage.

Checking Forward Drive Belt Tension

WARNING

Stop the engine, allow it to cool, disconnect the spark plug wire and prevent it from touching the spark plug, then remove the Engine Ignition key before performing any maintenance on your tiller.

Failure to follow these instructions could result in personal injury or property damage.

This test for the correct tension on the forward drive belt is the same check that you used when adjusting the handlebar height.

Please refer to Section 3, Handlebar Height Adjustment, for the correct procedures. If you get the 3/16" to 5/16" gap that is mentioned in the Handlebar Height Adjustment procedure, the tension on the forward drive belt is correct.

If you are unable to get the 3/16" to 5/16" gap when the lower end of the Forward Clutch Rod is in the correct hole in the swivel plate, your belt may be worn and you may have to make the secondary adjustment to the forward drive belt idler to take up slack. Please refer to "Adjusting the Forward Drive Belt Tension" in this Section.

Checking the Reverse Drive Belt Tension

WARNING

Stop the engine, allow it to cool, disconnect the spark plug wire and prevent it from touching the spark plug, then remove the Engine Ignition key before performing any maintenance on your tiller.

Failure to follow these instructions could result in personal injury or property damage.

1. Remove the two nuts that secure the belt cover to the tiller.
2. Position yourself at the front of the tiller and use your left hand to push the reverse idler arm inward as far as possible. While holding the arm at this position, look at the position of the belt tension guide mark on the reverse adjustable link. See Photo 5-13.
3. The belt tension is correct if the guide mark is anywhere to the left (as viewed from the front of the tiller) of the pin. If the guide mark is aligned with, or moves to the right side of the pin, then the belt is too loose and it must be adjusted. See "Adjusting Reverse Drive Belt Tension" in this Section.

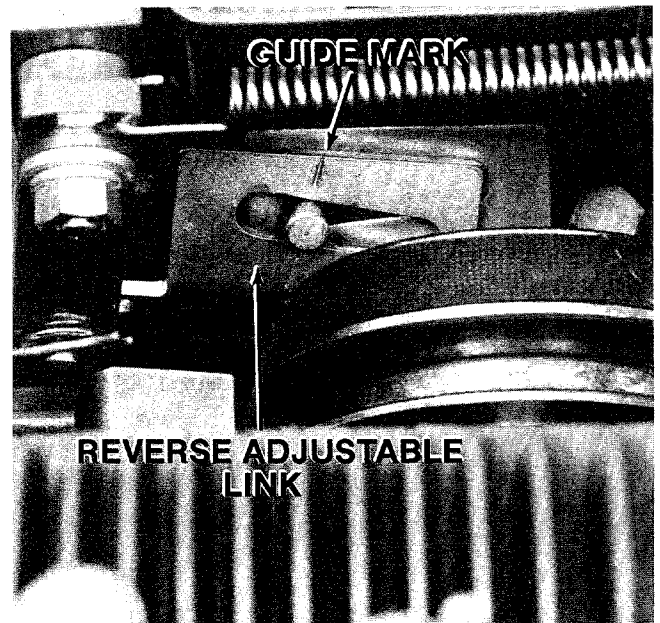

Photo 5-13: The guide mark on the Reverse Adjustable Link (all models).

4. If the belt tension is correct, reinstall the belt cover and secure it with the two nuts.

ADJUSTING THE FORWARD DRIVE BELT TENSION

WARNING

Stop the engine, allow it to cool, disconnect the spark plug wire and prevent it from touching the spark plug, then remove the Engine Ignition key before performing any maintenance on your tiller.

Failure to follow these instructions could result in personal injury or property damage.

To correctly adjust the tension on the forward drive belt, you must first make certain that the lower end of the Forward Clutch Lever is in the correct hole in the swivel plate as described in Section 3, Handlebar Height Adjustment.

If, after the handlebar height adjustment has been performed, you are still unable to get the 3/16" to 5/16" gap as described in that procedure, you will have to make a secondary adjustment to compensate for the slack in the worn belt. Do this as follows:

1. Remove the inner hairpin cotter from the lower end of the Forward Clutch Rod.
2. Unscrew the Forward Clutch Rod (counterclockwise as viewed from front of tiller) until the threaded upper end of the Forward Clutch Rod protrudes slightly above the rectangular nut in the Forward Clutch bracket. See Photo 5-14.

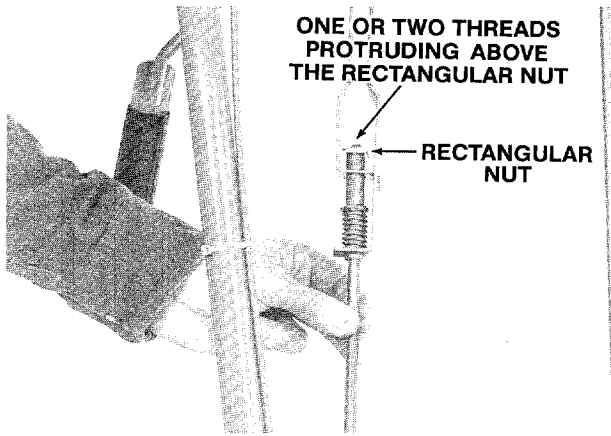

Photo 5-14: The correct distance to unscrew the Forward Clutch Rod—one or two threads above the rectangular nut.

3. Remove the belt cover.
4. Slip the forward drive belt off the engine-driven pulley by pushing it off with your left hand while pulling the engine starter rope with your right hand (pulling on the starter rope makes the pulley turn, aiding you in removing the belt).

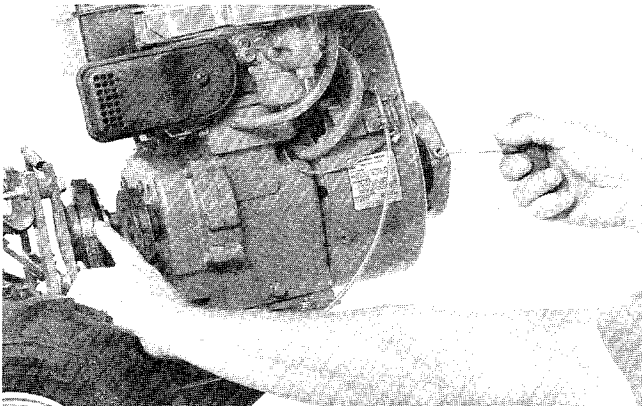

Photo 5-15: Slipping the Forward Drive Belt off the engine-driven pulley.

5. On the LEFT side of the tiller (as viewed from the operator's position) remove the hairpin cotter from the clevis pin that connects the forward idler arm to the forward adjustable link.

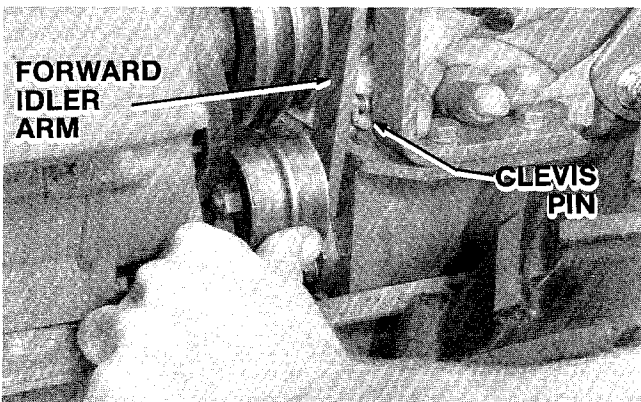

Photo 5-16: Removing the Clevis Pin from the Forward Idler Arm.

6. Push inward on the forward idler arm and remove the clevis pin.
7. Note the two holes in the forward adjustable link. Push inward on the forward idler arm and install the clevis pin through the **inside** hole in the forward adjustable link and back through the hole in the idler arm. Secure the clevis pin with the hairpin cotter.

IMPORTANT

While pushing inward on the forward idler arm, make certain that the forward drive belt is pushed off to the right-hand side of the tiller. This creates more room to install the clevis pin when you push the forward idler arm inward.

8. Place the forward drive belt in the grooves of both the engine drive pulley and the transmission pulley. Be sure the forward drive belt is to the inside of the metal belt guide (on the right-hand side of the tiller). Also—be sure the forward drive belt is to the inside of the forward drive idler pulley (on the left-hand side of the tiller).

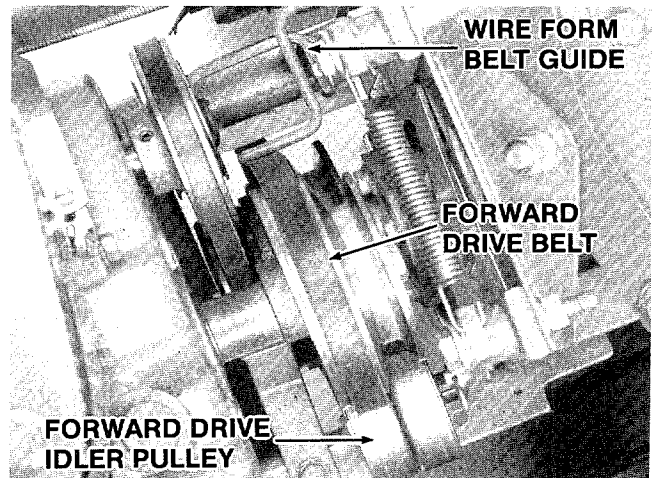

Photo 5-17: Overview of the belts and pulleys.

9. Readjust the forward drive belt tension by following the instructions in "Handlebar Height Adjustment" in Section 3.
10. Reinstall the belt cover and secure it in place with the two nuts.

IMPORTANT

With the clevis pin installed in the inner hole in the forward adjustable link, you will be limited in the number of future belt tension adjustments you can make. When the time comes, in future belt tension adjustments, that you can not screw the Forward Clutch Rod any farther into the rectangular nut in the Forward Clutch bracket, you must replace the forward drive belt. Before installing a new belt, be sure to return the clevis pin to the **outside** hole in the adjustable link.

REMOVING THE FORWARD DRIVE BELT

IMPORTANT: The Econo-Horse Model tiller has two forward speeds and one reverse speed, so its engine-driven forward pulley has two belt grooves and its lower transmission pulley has 3 belt grooves; the Pony and Junior Models have one forward speed and one reverse speed, so their engine-driven forward pulley has one belt groove instead of two, and their transmission pulley has two grooves instead of three.

WARNING

Stop the engine, allow it to cool, disconnect the spark plug wire and prevent it from touching the spark plug, then remove the Engine Ignition key before performing any maintenance on your tiller.

Failure to follow these instructions could result in personal injury or property damage.

1. Remove the reverse belt by following the instructions in "Removing the Reverse Drive Belt" given later in this section.
2. Move the forward drive belt completely off the forward engine pulley (this is the belt that's on the upper pulley furthest from the engine). Then, reach underneath the tiller and move the forward drive belt fully off the transmission pulley.

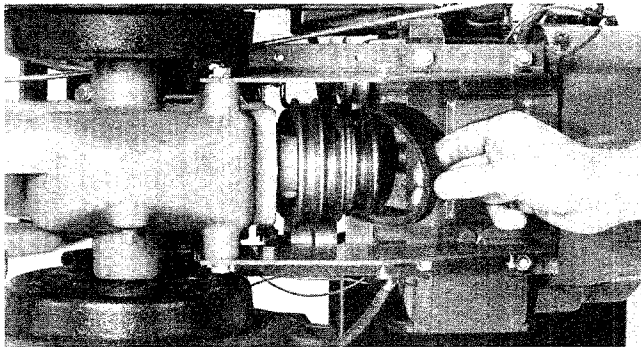

Photo 5-18: Moving the Forward Drive Belt off the transmission pulley. The triple-groove Econo-Horse transmission pulley is shown. The Pony and Junior have a double-groove pulley.

3. From the top of the tiller, grab the top of the forward drive belt and pull up on it to remove it. Guide it so that it doesn't hang up on anything.

INSTALLING THE FORWARD DRIVE BELT

NOTE: If you are installing both belts, you must install the forward drive belt first.

1. Thread the new forward drive belt downward, down between the rear of the engine-driven pulley and the forward drive idler arm.



Photo 5-19: Installing the Forward Drive Belt.

2. Push the forward drive belt down and over the front of the transmission pulley. If you need more working room, use a 3/8" wrench to loosen the belt guide on the left-hand side of the tiller and twist the belt guide out of the way.
3. Place the forward drive belt on the Econo-Horse in either the center groove or the rear groove on the transmission pulley (put belt in rear groove on Pony and Junior models). Then work the forward drive belt onto the corresponding groove in the engine-driven pulley (upper pulley). Make sure that the forward drive belt is to the inside of the wire belt guide (on the right hand side of the tiller).
4. If you previously loosened the belt guide, wait until you reinstall the reverse drive belt before securing the belt guide. This is so you can center the belt guide on the reverse drive belt.
5. Reinstall the reverse drive belt.
6. If you've installed a brand new belt, check the tension and adjust it after two hours of tilling.

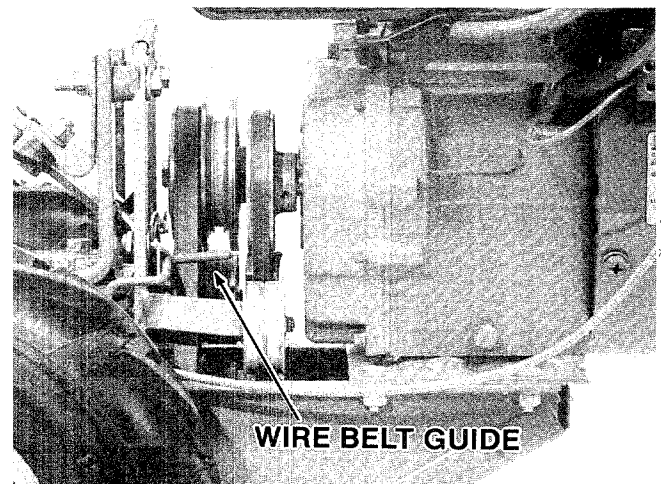

Photo 5-20: The Installed Forward Drive Belt.

REMOVING THE REVERSE DRIVE BELT

WARNING

Stop the engine, allow it to cool, disconnect the spark plug wire and prevent it from touching the spark plug, then remove the Engine Ignition key before performing any maintenance on your tiller.

Failure to follow these instructions could result in personal injury or property damage.

1. Remove the belt cover by removing the two nuts that secure it to the tiller.
2. Move the reverse drive belt off the reverse pulley (the pulley closest to the engine).

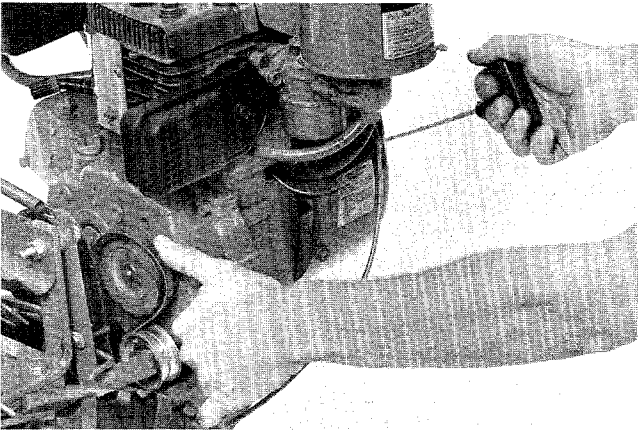

Photo 5-21: Moving Reverse Drive Belt off the reverse pulley.

3. Push downward on the reverse drive belt. Reach underneath the tiller and move the reverse drive belt off the transmission pulley.

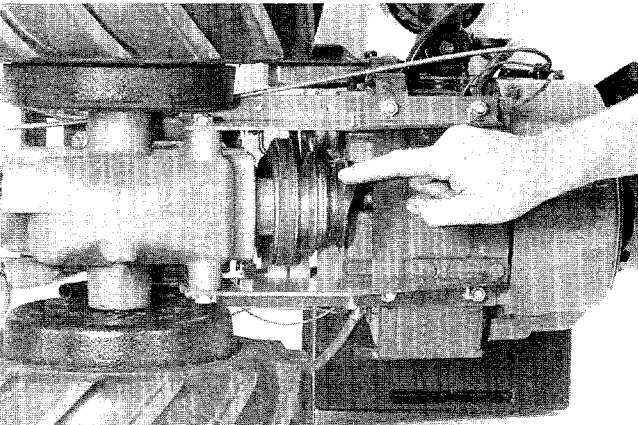

Photo 5-22: Moving Reverse Drive Belt off the transmission pulley.

4. Pull reverse drive belt up, guiding it so that it doesn't hang up anywhere.

INSTALLING THE REVERSE DRIVE BELT

NOTE: If you are installing both belts, you must install the forward drive belt before you install the reverse drive belt.

WARNING

Stop the engine, allow it to cool, disconnect the spark plug wire and prevent it from touching the spark plug, then remove the Engine Ignition key before performing any maintenance on your tiller.

Failure to follow these instructions could result in personal injury or property damage.

1. Push the reverse belt down, between the reverse pulley and the forward engine-driven pulley.

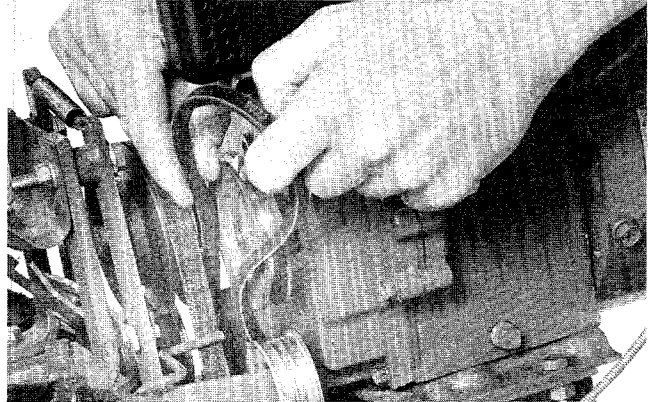

Photo 5-23: Installing the Reverse Drive Belt.

2. Loop the lower end of the reverse belt around the transmission pulley and fit it into the front groove in the transmission pulley.

3. Push the upper end of the reverse drive belt onto the reverse pulley. Make sure that the reverse drive belt goes to the inside of the reverse idler pulley.

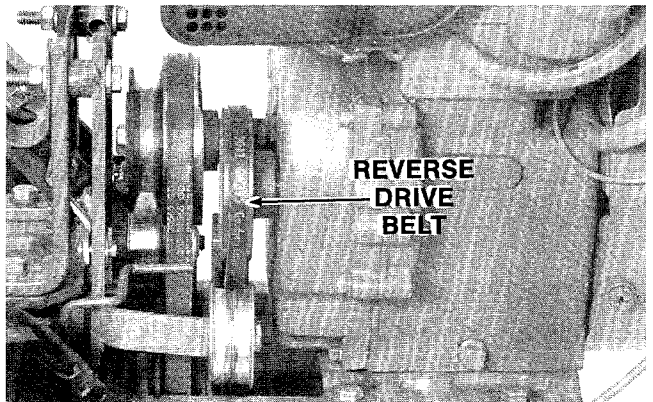

Photo 5-24: The installed Reverse Drive Belt.

4. If you loosened the reverse belt guide when installing the forward drive belt, center the guide on the reverse belt and tighten the hardware securing the reverse belt guide to the tiller frame.
5. Reinstall the belt cover. Securely tighten the two nuts that attach it to the tiller.

ADJUSTING REVERSE DRIVE BELT TENSION

The reverse idler pulley (on the right hand side of the tiller) regulates the amount of tension that is applied to the reverse drive belt. The following adjustment will allow the idler pulley to apply more tension to a loose belt.

WARNING

Stop the engine, allow it to cool, disconnect the spark plug wire and prevent it from touching the spark plug, then remove the Engine Ignition key before performing any maintenance on your tiller.

Failure to follow these instructions could result in personal injury or property damage.

1. Remove the belt cover.
2. Slip the reverse drive belt off the reverse pulley. This will create slack in the belt that will give you more room to work.
3. Remove the hairpin cotter from the clevis pin that connects the reverse idler arm to the reverse adjustable link. Then push in on the reverse idler arm and remove the clevis pin from the arm and link.

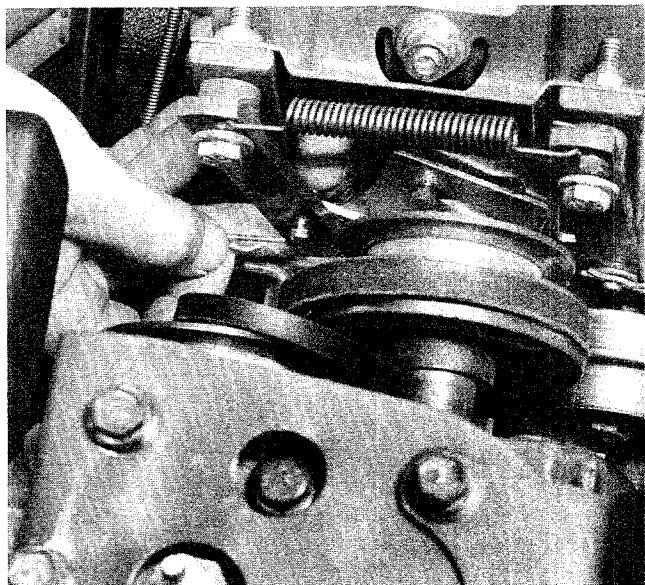

Photo 5-25: Removing Clevis Pin from Reverse Idler Arm.

4. Note the two holes in the reverse adjustable link. Push in on the reverse idler arm and install the clevis pin through the **inside** hole in the link and back through the hole in the idler arm. Secure the clevis pin with the hairpin cotter.

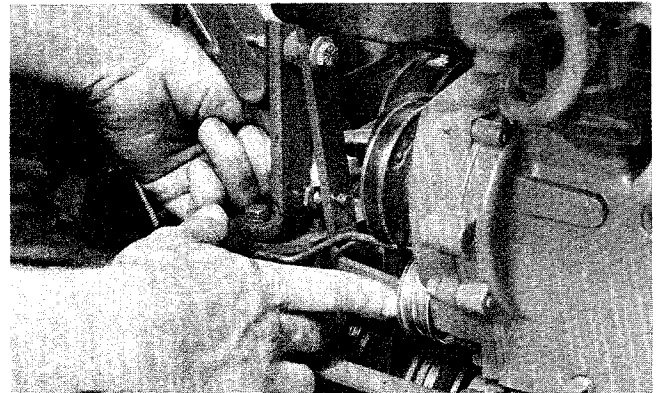

Photo 5-26: Installing Clevis Pin in **inside** hole in Reverse Adjustable Link.

5. Reinstall the reverse belt in the reverse pulley, making sure that the belt is located behind the reverse idler pulley.
6. Reinstall the belt cover and secure it in place with the two nuts.

IMPORTANT

If, in future tests for reverse belt tension (See "Checking Reverse Belt Tension", this Section), the guide mark on the reverse adjustable link should again align with, or move to the right side of the link pin, it means that the reverse belt is worn beyond adjustment. A new reverse belt must be installed. Before installing a new belt, be sure to return the clevis pin to the **outside** hole in the adjustable link.

WHEEL GEAR CABLE ADJUSTMENT (Econo-Horse and Pony Models only)

If you should ever move the Wheel Gear Lever to "ENGAGE" and find that you can roll the tiller forward or backward just the same as when the Wheel Gear Lever is in "DISENGAGE" (FREEWHEEL), you will have to readjust the Wheel Gear cable. Adjust the cable as follows:

WARNING

Stop the engine, allow it to cool, disconnect the spark plug wire and prevent it from touching the spark plug, then remove the Engine Ignition key before performing any maintenance on your tiller.

Failure to follow these instructions could result in personal injury or property damage.

1. Move the Wheel Gear Lever to "ENGAGE."
2. Loosen the top adjustment nut on the Wheel Gear cable bracket. It is located on the lower left rear of the transmission. Loosening this nut allows you to move the Wheel Gear cable down, which in turn pushes the eccentric lever down. Roll the tiller slightly forward or backward while you are pushing the Wheel Gear cable down. When the eccentric lever has been moved down far enough so it engages (locks) the wheels, hold the cable in that position and tighten both the top and bottom adjustment nuts.

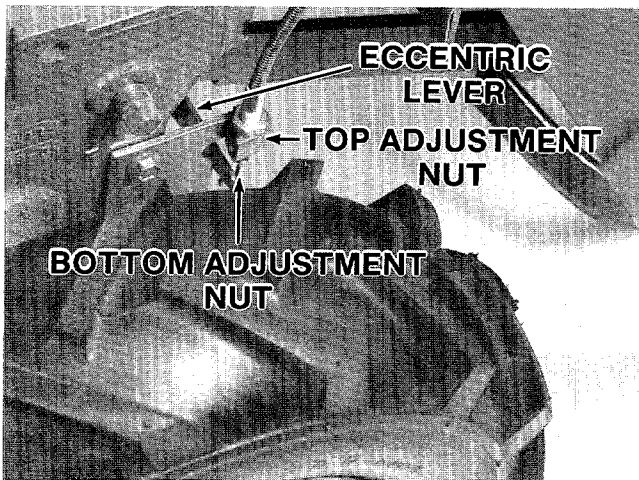

Photo 5-27: Adjusting Wheel Gear Cable. (Econo-Horse and Pony Models only.)

3. Move the Wheel Gear Lever to "ENGAGE" and then "DISENGAGE" (FREEWHEEL) several times to check your adjustment. You should not be able to roll the tiller when the Wheel Gear Lever is in "ENGAGE." You should be able to roll the tiller when the Wheel Gear Lever is in "DISENGAGE" (FREEWHEEL).

ENGINE THROTTLE CABLE ADJUSTMENT

The end of the Engine Throttle cable is fastened to the throttle cable bracket on the right side of the engine. When you move the Engine Throttle Lever to "FAST", the throttle wire moves a control arm over until it contacts the high speed stop on the throttle cable bracket. By moving the Engine Throttle Lever to "STOP", the throttle wire moves the control arm back so it contacts the shut off switch. This grounds the ignition and stops the engine.

If the throttle arm doesn't reach the high speed stop (engine doesn't reach high speed):

1. Move the Engine Throttle Lever to "FAST."
2. Loosen the Engine Throttle cable clamp screw and move the cable over until the throttle arm contacts the stop.
3. Retighten the Engine Throttle cable clamp.

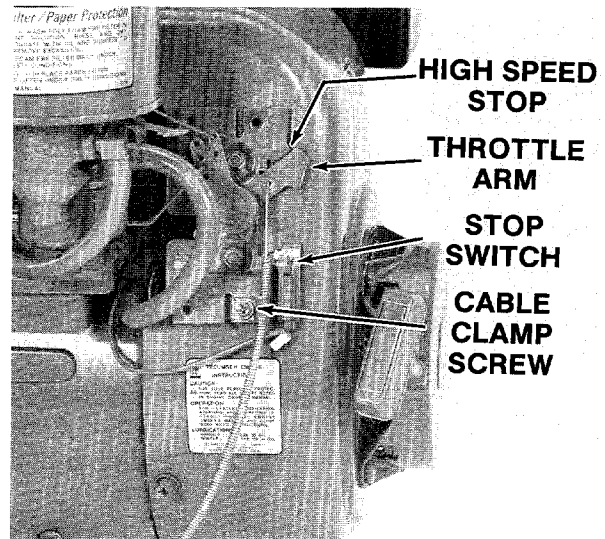

Photo 5-28: Engine Throttle Cable adjustment. The 6HP Tecumseh engine on the Econo-Horse Model is shown—but all engines are very similar.

If the throttle arm doesn't touch the stop switch as you move the Engine Throttle Lever to STOP:

1. Move the Engine Throttle Lever to "STOP."
2. Loosen the Engine Throttle cable clamp screw and move the cable over until the throttle arm contacts the stop switch.
3. Retighten the Engine Throttle cable clamp. Lightly lubricate the cable with oil.

OFF SEASON STORAGE

1. Run the engine until all the gasoline is used. Do not store the tiller with gasoline in the fuel tank because gum deposits could form on the carburetor parts and in the fuel lines and tank.

NOTE: If "Gasohol" has been used in your engine, refer to Engine Owner's Manual for instructions on engine storage. Be certain Gasohol is OK to use in the engine!

2. While the engine is still warm, drain the engine crankcase oil. Refill with fresh oil.
3. Remove the spark plug. Put 1-ounce of motor oil in the cylinder. Crank the engine slowly to distribute the oil. Replace the spark plug.
4. Clean dirt or chaff from the cylinder head, blower housing, screen, and muffler areas.
5. Check all nuts and bolts for tightness.
6. Perform lubrication and air cleaner service.
7. For electric start models, charge the battery and store it in a cool, dry place.
8. Cover the tiller and store it in a cool, dry place.
9. Remember—now is a good time to order replacement parts for the next tilling season.

TROUBLESHOOTING –ELECTRIC START SYSTEM (IF SO EQUIPPED)

Starter Motor Doesn't Turn Over

If your starter motor won't turn over when you turn the Ignition Switch key to "START", it could be due to one or more of the following causes:

1. Loose, broken, or corroded wires or cables.
2. Discharged battery.
3. A solenoid that isn't working.
4. A starter motor that isn't working.
5. An Ignition Switch that is broken.
6. A faulty wiring harness and / or a faulty Ignition Switch.

IMPORTANT

Here are simple checks you can make. If these checks do not isolate the problem, call our Technical Service Department for further advice. Be sure to wear safety glasses!

1. Check ALL wires and cables.

- a. Make sure that all connections are tight.
- b. At all connections, check for rust that would prevent good electrical contact.
- c. Make sure that the insulation on all wires and cables is in good shape. Make sure that a break in the insulation is not allowing a bare wire to touch any metal surfaces.
- d. After completing steps a through c, start the engine. If it starts, you've corrected the problem. If it doesn't start, proceed to step 2.

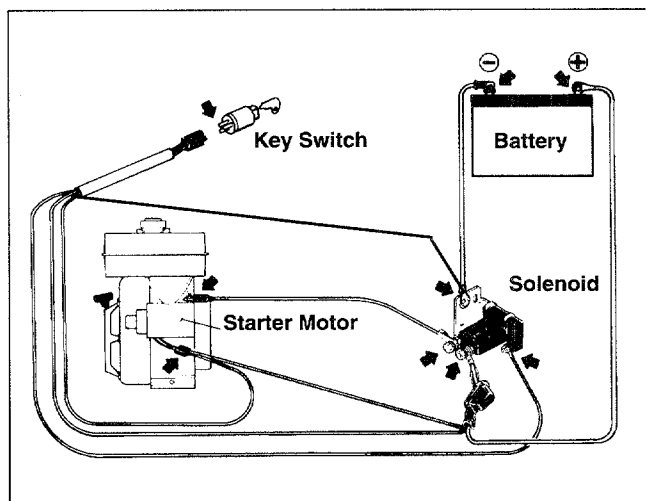

Sketch 5-29: Check all connections.

2. Your battery may be discharged.

- a. You can allow the tiller to run outdoors for approximately 45 minutes or longer to make sure that the battery is charged. Be sure that the battery is filled to the "UPPER LEVEL" line on the battery before you start the engine.

- b. After running the tiller, shut it off and try to restart it by using the Ignition Switch. If it starts, your problem was a discharged battery. If it doesn't start, proceed to the next step.

3. Your solenoid is bad. Remove the negative battery cable. You'll be using it as a jumper wire. Make a temporary, replacement negative battery cable by stripping about 3/4" of insulation from both ends of a 12" piece of heavy-gauge wire (#10 or larger).

- a. Make sure that both the Maneuvering Clutch and the Forward Clutch are in their disengaged position.

- b. Touch one end of the removed negative battery cable to the solenoid terminal identified as "B" in Sketch 5-30.

- c. BRIEFLY touch the other end of the removed negative battery cable to the solenoid terminal identified as "C" in Sketch 5-30. If the starter motor turns over, your solenoid is working. If the starter motor didn't turn over, your solenoid may be bad. First check to make sure that the screws which attach the solenoid to the battery bracket are tight.

- d. After tightening the solenoid screws, repeat step c. If the starter motor still doesn't turn over, please call our Technical Service Department for further advice.

- e. If there was no spark when you jumped the solenoid, it indicates that your battery will not hold a charge. You should remove the battery from the tiller and take it to a qualified battery technician for testing.

- f. Remove the temporary battery cable and re-install the original negative battery cable.

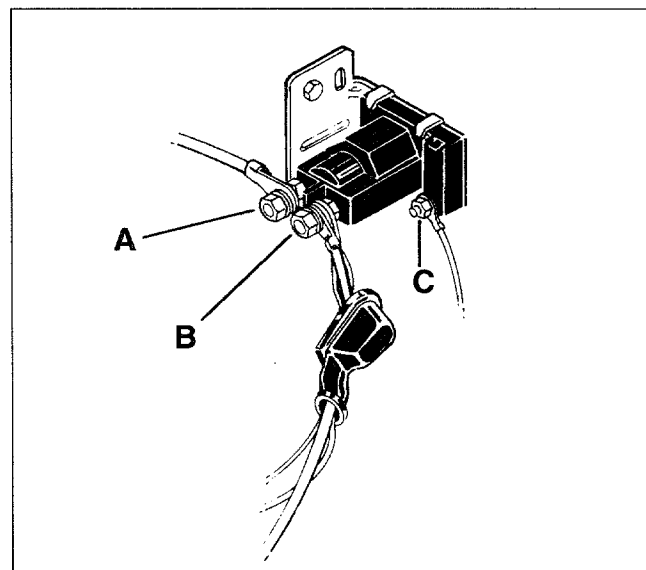

Sketch 5-30: Touch ends of removed Negative Battery Cable to "B" and "C" to test solenoid. Touch cable to "A" and "B" to test starter motor.

4. Your starter is not working.

- a. Make sure that both the Maneuvering Clutch and the Forward Clutch are in their disengaged positions.
- b. Remove the wire harness receptacle from the back of the Ignition Keyswitch. Clean corrosion off the contact prongs on the back of the keyswitch. Next, clean corrosion out of the sockets in the receptacle (you may have a 5-hole or a 3-hole plastic receptacle).
- c. Insert the ends of the jumper wire (that you made in the previous step) into the sockets

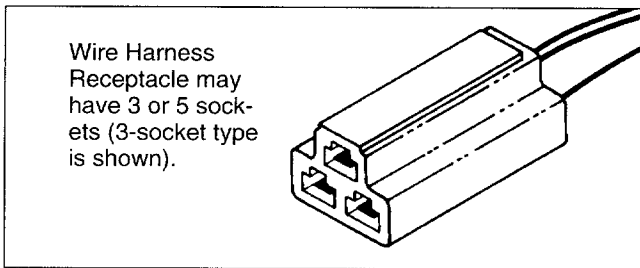

Sketch 5-31: Ignition Switch Receptacle.

which have the red wires going into them.

- d. If the starter motor turns over, your problem is with the Ignition Switch. Call our Technical Service Department for further advice.
 - e. If the starter motor didn't turn over, you have a faulty wiring harness and / or a faulty Ignition Switch.
- #### 5. You have a faulty wiring harness and / or a faulty Ignition Switch.

- a. You will have to purchase a continuity tester or make one from two flashlight batteries, some wire, a flashlight bulb, and some tape. Refer to Sketch 5-32 to see how to make one.
- b. Remove the wiring harness from the engine, switch, and solenoid. Test each of the red wires for continuity by placing the continuity tester wires at both ends of a single wire of the wiring harness. If the lamp lights, electricity is flowing and the wire is not broken. Repeat this step for the other two wires.

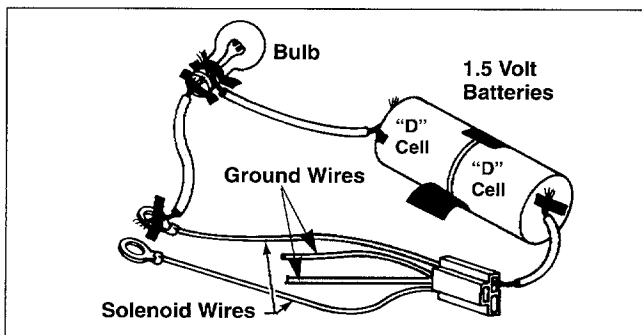

Sketch 5-32: Testing wires for continuity.

- c. If all wires in the wiring harness are unbroken, you may have either a faulty ignition keyswitch or a bad ground connection. If so,

please contact our Technical Service Department for further assistance. The problem will be identified and the appropriate repair will be suggested. Any parts you may need to order will be shipped to you promptly.

BATTERY CARE / MAINTENANCE (IF SO EQUIPPED)

DANGER

Follow the battery safety rules given in Sections 1 and 2 of this Manual. Failure to carefully follow all Safety Rules may result in personal injury or property damage from such causes as an explosion of battery gases, acid burns, or electrical burns.

Care in Service

1. Once a month or every 10 operating hours, whichever occurs first, check the level of the electrolyte solution. Make certain it is filled to the "UPPER LEVEL" line that is marked on the battery case. If necessary, add distilled or demineralized water to restore the electrolyte to the correct level. **Never Use Battery Acid To Refill The Battery.** Replace the battery caps securely and wipe the battery top after filling. Then run the engine outdoors for about 20 minutes at 3/4-speed to recharge and recirculate the electrolyte solution. For safety, do not leave the tiller unattended while the engine is running.

DANGER

Electrolyte is sulfuric acid solution. Avoid spillage and contact with skin, eyes, and clothing. Wear protective clothing and rubber gloves; also shield eyes with safety goggles when working near the battery.

2. Keep the battery clean at all times. If you find corrosion on the battery posts or cable terminals, remove the battery and clean it with a solution of baking soda and water. (Tighten the battery caps securely before cleaning the battery and do not allow any of the baking soda / water solution to enter any of the battery cells. Be sure to clean any remaining solution off the battery.)

You can use a wire brush, sandpaper, or steel wool to clean the posts and terminals. After cleaning, coat the posts and terminals with petroleum jelly or silicone grease to prevent new corrosion from forming.

3. Periodically check the entire electrical system for loose or dirty connections.

4. Periodically check the battery clamp for tightness. It should hold the battery firmly in place. However, you should not overtighten the battery

clamp as this could damage the battery case.

5. Periodically check that the vent tube is not crimped or pinched anywhere along its length.

Battery Storage

The optional electric start engine has a recharging circuit that will properly maintain the battery's state of charge during the regular tilling season. When the tiller won't be used for an extended period of time, we recommend that you fully charge the battery before placing it in storage. Before reinstalling the battery after storage, give it a thorough recharge.

DANGER

Batteries generate explosive gases. Keep sparks and flames away from the battery at all times.

Ventilate the area when charging or using the battery in an enclosed area.

CARBURETOR ADJUSTMENT

The carburetor on your tiller's engine has been adjusted at the factory for best operating speed and air/fuel mixture. Readjustment of the carburetor should not be necessary.

Operators shall not tamper with the engine-governor settings on the machine; the governor controls the maximum safe operating speed and protects the engine and all moving parts from damage caused by overspeed. Authorized service shall be sought if a problem exists.

Changing the engine governed speed will void the engine warranty.

WARNING

Do not tamper with the engine governor. It is set for proper engine speed.

Overspeeding the engine above the engine manufacturer's recommended high speed setting could result in property damage or personal injury.

ECONO-HORSE TILLER SPECIFICATIONS

ENGINE

Type—

Tecumseh; four-cycle, single-cylinder, air-cooled, horizontal crankshaft, overhead valve, primer-button choke, solid state electronic ignition.

Horsepower—

6

Fuel Tank Capacity—

1 gallon.

Fuel Requirements—

Unleaded Regular or Premium Grade gasoline.

Engine Oil—

API Service SF, SG, SH or SH/CD.
SAE30W oil above 32°F. SAE5W30 oil below 32°F. (SAE10W is an acceptable substitute.)
(Do not use 10W40 oil.)

Engine Oil Capacity

21 ounces; however, always use the engine dipstick to verify that the level of the engine oil is correct.

Spark Plug Type

Champion RN4C only.
A resistor plug must be used for replacement.

Spark Plug Gap

.030 inch.

TILLER

Height—

Without handlebars:
Recoil Start Model.....24-3/4"
With handlebars in low position38-1/4"
With handlebars in high position46-1/2"

Length—

With handlebars in low position64-1/2"
Without handlebars46-7/8"

Width

Hood width20-1/8"
Tilling width.....18"
Width at top of handlebars20"

Weight

Recoil start model236-lbs.

Wheel and Tire Size

5.00 x 6"; 15-to-20 psi (pounds / sq. inch)

Transmission

Gear oil capacity: 3/4 pints (52-to-54 ozs.)
Small Top-Offs: SAE 140, SAE 85W-140, or SAE 80W-90 weight gear oil with an API rating of either GL-4 or GL-5.
Full Replacement: SAE 140 or SAE 85W-140 weight gear oil with an API rating of GL-4 only.

PONY TILLER SPECIFICATIONS

ENGINE

Type—

Briggs & Stratton; four-cycle, single-cylinder, air-cooled, horizontal crankshaft, manual choke, solid state electronic ignition.

Horsepower—

5

Fuel Tank Capacity—

3 quarts.

Fuel Requirements—

Unleaded or leaded Regular Grade gasoline.

Engine Oil—

API Service SE, SF, or SG.
40°F to 100°F: SAE 30W oil.
0°F to 40°F: SAE 5W30 oil or SAE 10W30 oil.
-20°F to 40°F: Synthetic 5W-20 or 5W-30 oil.

Engine Oil Capacity

20 ounces; however, always fill to the top of the oil fill tube.

Spark Plug Type

Champion J-8C (or equivalent). Canadian models: RJ-17LM.

Spark Plug Gap

.030 inch.

TILLER

Height—

Without handlebars:
Recoil Start Model.....24"
With handlebars in low position38-1/4"
With handlebars in high position48"

Length—

With handlebars in low position.....62"
Without handlebars47"

Width

Hood width16-1/2"
Tilling width.....16"
Width at top of handlebars20"

Weight

Electric start model185-lbs.
Recoil start model165-lbs.

Wheel and Tire Size

4.10 x 6"; 15-to-20 psi (pounds / sq. inch)

Transmission

Gear oil capacity: 3/4 pints (52-to-54 ozs.)
Small Top-Offs: SAE 140, SAE 85W-140, or SAE 80W-90 weight gear oil with an API rating of either GL-4 or GL-5.
Full Replacement: SAE 140 or SAE 85W-140 weight gear oil with an API rating of GL-4 only.

JUNIOR TILLER SPECIFICATIONS

ENGINE

Type—

Tecumseh; four-cycle, single-cylinder, air-cooled, horizontal crankshaft, manual choke, solid state electronic ignition.

Horsepower—

4

Fuel Tank Capacity—

2 quarts.

Fuel Requirements—

Clean, fresh, lead-free, automotive gasoline

Engine Oil—

API Service SF, SG, SH or SH/CC. SAE30W above 32°F. Below 32°F use SAE 5W30 (SAE 10W is an acceptable substitute). Do not use 10W40 motor oil.

Engine Oil Capacity

21 ounces; however, always fill to the top of the oil fill tube.

Spark Plug Type

Champion J-8 (or equivalent) or Autolite 356 (or equivalent). Canadian models: RJ-17LM.

Spark Plug Gap

.030 inch.

TILLER

Height—

Without handlebars:20"
With handlebars in low position37-1/2"
With handlebars in high position47"

Length—

With handlebars in low position52-1/2"
Without handlebars45"

Width

Hood width16-1/2"
Tilling width14"
Wheel width18-5/8"
Width at top of handlebars19-1/2"

Weight

Recoil start model149-lbs.

Wheel and Tire Size

3.25 x 5"; 15-to-20 psi (pounds / sq. inch)

Transmission

Gear oil capacity: 3½ pints (55-to-57 ozs.)
Small Top-Offs: SAE 140, SAE 85W-140, or SAE 80W-90 weight gear oil with an API rating of either GL-4 or GL-5.
Full Replacement: SAE 140 or SAE 85W-140 weight gear oil with an API rating of GL-4 only.

RECOMMENDED MAINTENANCE INTERVALS

MAINTENANCE PROCEDURE	Before Each Use	Every 10 Hours	Every 25 Hours	Every 30 Hours	Every 50 Hours
Check Engine Oil Level *	•				
Clean Engine Cooling Fins	•				
Check Bolts and Nuts **		•			
Check Tension on Drive Belts **		•			
Change Engine Oil ***		•			
Oil and Grease Tiller		•			
Service Air Cleaner Foam Pre-Cleaner(not on Junior)		•			
Check Transmission Gear Oil Level **				•	
Check Tines for Wear				•	
Check Spark Plug					•
Replace Air Cleaner Paper Filter	† See schedule below for each engine				

* Check oil level after every 5 operating hours.

** Check after first 2 hours of break-in operation.

*** Change more frequently in dusty or dirty conditions. (Change after first 2 hours of break-in operation.)

† 6HP Econo-Horse— Replace paper air filter every 100 hours.

† 5HP Pony Model— Replace paper air filter every 50 hours.

† 4HP Junior Model— Replace paper air filter every 25 hours.

TROUBLESHOOTING

Before performing any of the corrections in this Troubleshooting Chart, refer to the appropriate information contained in this Manual for the correct safety precautions and operating or maintenance procedures. Contact your local authorized Engine Service Dealer for engine service. Contact your local authorized TROY-BILT dealer or the factory Technical Service Department for service problems with the machine.

PROBLEM	POSSIBLE CAUSE	CORRECTION
Engine does not start.	<ol style="list-style-type: none"> 1. Spark plug wire disconnected. 2. Engine Throttle Control Lever incorrectly set. 3. Fuel tank empty. 4. Choke control in incorrect position. 5. Stale gasoline. 6. Dirty air filter(s). 7. Defective or incorrectly gapped spark plug. 8. Carburetor out of adjustment. 9. Misadjusted Throttle Control cable. 10. Dirt or water in fuel tank. 	<ol style="list-style-type: none"> 1. Reconnect wire. 2. Put lever in START position. 3. Add fuel. 4. Move choke to proper position (see "Engine Controls," Section 3). 5. Drain fuel and add fresh fuel. 6. Clean or replace filter(s). 7. Inspect spark plug. 8. See Engine Service Dealer. 9. See "Engine Throttle Cable Adjustment" (Section 5). 10. See Engine Service Dealer.
Keyswitch does not start engine. (electric start models only)	<ol style="list-style-type: none"> 1. Electrical connections loose or disconnected. 2. Battery discharged. 3. Broken wire in wiring system. 4. Malfunctioning starter motor. 5. Corroded battery terminals. 6. Poor contact on ground wire terminals. 	<ol style="list-style-type: none"> 1. Tighten or reconnect wiring. 2. Charge battery (see Section 2). 3. Replace broken wiring. 4. Contact local Engine Service Dealer. 5. Clean corroded terminals (see "Troubleshooting Electric Start System"— Section 5). 6. Scrape paint off terminals.
Engine runs poorly.	<ol style="list-style-type: none"> 1. Defective or incorrectly gapped spark plug. 2. Dirty air filter(s). 3. Carburetor out of adjustment. 4. Stale gasoline. 5. Dirt or water in fuel tank. 6. Engine cooling system clogged. 	<ol style="list-style-type: none"> 1. Inspect spark plug. 2. Clean or replace. 3. See Engine Service Dealer. 4. Drain gasoline and add fresh gasoline. 5. See Engine Service Dealer. 6. Clean air cooling area.
Engine overheats.	<ol style="list-style-type: none"> 1. Engine cooling system clogged. 2. Carburetor out of adjustment. 3. Oil level is low. 	<ol style="list-style-type: none"> 1. Clean air cooling areas. 2. See Engine Service Dealer. 3. Check oil. Add if needed.
Engine does not shut off.	<ol style="list-style-type: none"> 1. Misadjusted Throttle Control cable. 	<ol style="list-style-type: none"> 1. Adjust Throttle Control cable (see Section 5).
Wheels and Tines will not turn.	<ol style="list-style-type: none"> 1. Improper use of controls. 2. Forward Drive— Forward Clutch Rod not in correct swivel plate hole. 3. Reverse Drive— broken or misadjusted belt. 4. Worn, broken, or misadjusted drive belt(s). 5. Internal transmission wear or damage. 6. Bolt and key loose in transmission pulley. 	<ol style="list-style-type: none"> 1. Review Sections 3 and 4. 2. See "Handlebar Height Adjustment" (Section 3). 3. Replace belt or adjust belt tension. 4. See "Checking Drive Belt Tension" (Section 5). 5. Contact local Dealer or the Factory. 6. Tighten bolt; verify key in place.
Tines turn, but wheels don't.	<ol style="list-style-type: none"> 1. Pony and Econo-Horse Models: wheel mounting hardware missing. 2. Junior Model: wheel drive pins missing or incorrectly located. 3. Bolt and key loose in transmission pulley. 	<ol style="list-style-type: none"> 1. Replace hardware. 2. Replace wheel pins in WHEEL DRIVE position (see Section 3). 3. Tighten bolt; verify key in place.

TROUBLESHOOTING

PROBLEM	POSSIBLE CAUSE	CORRECTION
(cont. from Page 50)	<ol style="list-style-type: none"> 4. Internal transmission wear or damage. 5. Econo-Horse and Pony: misadjusted Wheel Gear Cable. 6. Econo-Horse and Pony: Wheel Gear Lever not fully engaged. 	<ol style="list-style-type: none"> 4. Contact local Dealer or the Factory. 5. See "Wheel Gear Cable Adjustment" (Section 5). 6. Engage lever (see Section 3).
Wheels Turn, but Tines Don't.	<ol style="list-style-type: none"> 1. Tine holder mounting hardware missing. 2. Internal transmission wear or damage. 	<ol style="list-style-type: none"> 1. Replace hardware. 2. Contact local Dealer or the Factory.
Poor tilling performance.	<ol style="list-style-type: none"> 1. Worn tines. 2. Improper Depth Regulator setting. 3. Incorrect throttle setting (all models) or belt speed (Econo-Horse only). 4. Belt(s) slipping. 	<ol style="list-style-type: none"> 1. See "Bolo Tines" (Section 5). 2. See "Tilling in the Garden" (Section 4). 3. See Section 4. 4. See Forward Clutch Rod location in Section 3. See "Checking Drive Belt Tension" in Section 5.
Battery (if so equipped) does not charge during engine operation.	<ol style="list-style-type: none"> 1. Broken wiring in engine recharging circuit. 2. Malfunctioning engine recharging system. 3. Discharged or dead battery. 	<ol style="list-style-type: none"> 1. Contact Engine Service Dealer. 2. Contact Engine Service Dealer. 3. See "To Charge the Battery" in Section 2. Replace a dead battery.

INDEX

A

Air Cleaner.....36-37
Assembly Steps7
Authorized Service.....3

B

Battery
Charging14
Installing.....16
Storage47
Belts.....38-43
Adjusting39, 43
Replacing.....41, 42, 43
Changing Speeds
Econo-Horse.....26,27,29

C

Cable, Throttle44
Carburetor Adjustments.....47
Choke23
Cleaner, Air.....36-37
Claims, Freight.....3, 8
Composting.....30
Cooling Fins.....37
Controls, Tiller & Engine18
Crop Residues30
Cultivating28
Clutch,
Forward Drive Lever20
Clutch, Maneuvering.....20

D

Decals.....6
Depth Regulator Lever....21, 27
Drive BeltsSee Belts

E

Electric Start System
Assembly14
Maintenance47
Operation23
Troubleshooting45, 46
Engine
Air Cleaner.....36-37
Choke23
Cooling Fins.....37
Controls22
Fuel.....48-49
Oil.....11, 35, 48-49
Service Dealers3
Starting22-23
Stopping.....23
Storage44
Throttle Cable44

F

Fins, Engine Cooling.....37
Footprints29
Forward Drive Clutch20
Forward Motion19, 20, 25
Freight Damage3, 8
Fuel.....48-49

G

Gardening27-32
Gasoline48-49
Gear Oil, Transmission ...10, 34
Grease,
Lubrication Points33, 34

H

Handlebars8, 21
Hillside Tilling31, 32

I

Ignition Switch.....23, 45, 46

J, K

L

Lever (See Clutch)
Loading32
Lubrication Points33, 34

M

Maintenance33-47
Engine35-37, 44, 47-49
Tiller33-44
Maneuvering Clutch.....20
Motor Oil.....11, 35, 48

N

O

Off-Season Storage44
Oil, Engine11, 35, 48-49
Oil,
Transmission Gear.....10,34
Oil Leaks.....34
Operating the Tiller24
Ordering Tiller Parts.....3

P

Power Composting30
Pulleys (See Belts)
"Paddles", Forward Drive
(See Clutch, Forward Drive)

Q

R

Reverse20
Operating in Reverse ..20, 30
Repairs/Adjustments33-47

S

Safety Instructions4-5
Seedbed Preparation.....27-28
Serial Number-Tiller2
Shut-Off Switch44
Sloping Ground.....31, 32
Solenoid.....45
Speeds, Changing
Econo-Horse.....26, 27, 29
Spark Plug37, 48-49
Specifications48-49
Starting and
Stopping Engine....22, 23, 25
Stopping Tiller25
Switch, Ignition.....23, 45, 46

T

Terrace Gardening31, 32
Throttle Lever & Controls.....23
Tiller & Engine
Maintenance33-47
Tiller Operation24
Tiller Serial Number2
Tines, Bolo37, 38
Tire Pressure13
Travel Position-Depth
Regulator Lever21-22
Troubleshooting50-51
Turning Tiller Around.....25

U

Unloading Tiller.....32
Untangling Tines29
Uphill Tilling.....31, 32

V

W

Wheel Drive Pins
Junior19
Wheel Gear Lever.....18
Wheels.....48-49

X, Y, Z

NOTES



For customer assistance, contact your nearest authorized dealer or:

GARDEN WAY INCORPORATED • 1 Garden Way • Troy, New York 12180

Customer Service: 1-800-437-8686 • Technical Service: 1-800-520-5520 • Parts Service: 1-800-648-6776 • FAX: (518) 391-7332

Outside the U.S.A. and Canada:

Customer Service: (518) 391-7007 • Technical Service: (518) 391-7008 • Parts Service: (518) 391-7006 • FAX: (518) 391-7332

Free Manuals Download Website

<http://myh66.com>

<http://usermanuals.us>

<http://www.somanuals.com>

<http://www.4manuals.cc>

<http://www.manual-lib.com>

<http://www.404manual.com>

<http://www.luxmanual.com>

<http://aubethermostatmanual.com>

Golf course search by state

<http://golfingnear.com>

Email search by domain

<http://emailbydomain.com>

Auto manuals search

<http://auto.somanuals.com>

TV manuals search

<http://tv.somanuals.com>