



Operator's Manual

Rear-tine PTO Tiller Models

682J—Horse™

E686N—Horse™

E682L—Horse™



Model 682J Shown

IMPORTANT: READ SAFETY RULES AND INSTRUCTIONS CAREFULLY

Warning: This unit is equipped with an internal combustion engine and should not be used on or near any unimproved forest-covered, brush-covered or grass-covered land unless the engine's exhaust system is equipped with a spark arrester meeting applicable local or state laws (if any). If a spark arrester is used, it should be maintained in effective working order by the operator. In the State of California the above is required by law (Section 4442 of the California Public Resources Code). Other states may have similar laws. Federal laws apply on federal lands. A spark arrester for the muffler is available by contacting the service department at Troy-Bilt LLC, P.O. Box 361131 Cleveland, Ohio 44136-0019.

TROY-BILT LLC, P.O. BOX 361131, CLEVELAND, OH 44136-0019

PRINTED IN USA

FORM NO. 770-10598C
(9/2003)

TABLE OF CONTENTS

Content	Page	Content	Page
Customer Support	2	Maintenance	28
Safety	3	Troubleshooting	41
Assembly	6	Attachments & Accessories	43
Features and Controls	11	Parts List	44
Operation	14	Warranty Information	Back Cover

FINDING MODEL NUMBER

This Operator's Manual is an important part of your new rear-tine tiller. It will help you assemble, prepare and maintain the unit for best performance. Please read and understand what it says.



Before you start assembling your new equipment, please locate the model plate on the equipment and copy the information from it in the space provided below. A sample model plate is also given below. You can locate the model plate by standing behind the unit and looking down at rear surface of the tine shield. This information will be necessary to use the manufacturer's web site and/or help from the Customer Support Department or an authorized service dealer.

TROY-BILT LLC
 P. O. BOX 361131
 CLEVELAND, OH 44136
330-558-7220
1-800-520-5520

www.troybilt.com

Copy the model number here: _____

Copy the serial number here: _____

CUSTOMER SUPPORT

Please do NOT return the unit to the retailer from where it was purchased, without first contacting Customer Support.

If you have difficulty assembling this product or have any questions regarding the controls, operation or maintenance of this unit, you can seek help from the experts. Choose from the options below:

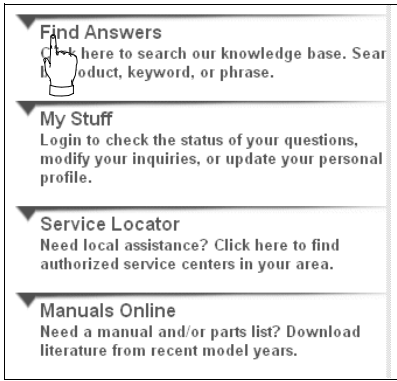
	<p>Visit troy-bilt.com for many useful suggestions. Click on Customer Support button and you will get the four options reproduced here. Click on the appropriate button and help is immediately available.</p> <div style="text-align: center; margin: 10px 0;">  </div> <p style="text-align: center; color: gray; font-style: italic;">The answer you are looking for could be just a mouse click away!</p>	<p style="color: gray; font-style: italic;">The answer you are looking for could be just a mouse click away!</p>
	<p>If you prefer to reach a Customer Support Representative, please call 1(800) 520-5520.</p>	
	<p>The engine manufacturer is responsible for all engine-related issues with regards to performance, power-rating, specifications, warranty and service. Please refer to the engine manufacturer's Owner's/Operator's Manual, packed separately with your unit, for more information.</p>	

Section 1 Safety

Safety Alert Symbol



This is a safety alert symbol. It is used in this manual and on the unit to alert you to potential hazards. When you see this symbol, read and obey the message that follows it.

Failure to obey safety messages could result in personal injury or property damage.

This machine meets voluntary safety standard B71.8 – 1996, which is sponsored by the Outdoor Power Equipment Institute, Inc., and is published by the American National Standards Institute.



WARNING

The engine exhaust from this product contains chemicals known to the State of California to cause cancer, birth defects or other reproductive harm.

Training

1. Carefully read this Owner's Manual, the separate Engine Owner's Manual, and any other literature you may receive. Be thoroughly familiar with the controls and the proper use of the tiller and its engine. Know how to stop the unit and disengage the controls quickly.
2. Never allow children to operate the tiller. Never allow adults to operate the tiller without proper instruction.
3. Keep the area of operation clear of all persons, particularly children and pets.
4. Keep in mind that the operator or user is responsible for accidents or hazards occurring to other people, their property, and themselves.

Preparation

1. Thoroughly inspect the area where the tiller is to be used and remove all foreign objects.
2. Put the Wheels/Tines/PTO Drive Lever into NEUTRAL before starting the engine.
3. Do not operate the tiller without wearing adequate outer garments. Avoid loose garments or jewelry that could get caught in moving parts.
4. Do not operate the tiller when barefoot or wearing sandals, sneakers, or light footwear. Wear protective footwear that will improve footing on slippery surfaces.
5. Do not till near underground electric cables, telephone lines, pipes or hoses. If in doubt, contact your telephone or utility company.

6. Warning: Handle fuel with care; it is highly flammable and its vapors are explosive. Be sure to take the following precautions:

- a. Store fuel in containers specifically designed for this purpose.
 - b. The gas cap shall never be removed or fuel added while the engine is running. Allow the engine to cool for several minutes before adding fuel.
 - c. Keep matches, cigarettes, cigars, pipes, open flames, and sparks away from the fuel tank and fuel container.
 - d. Fill fuel tank outdoors with extreme care. Never fill fuel tank indoors. Use a funnel or spout to prevent spillage.
 - e. Replace all fuel tank and container caps securely.
 - f. If fuel is spilled, do not attempt to start the engine, but move the machine away from the area of spillage and avoid creating any source of ignition until fuel vapors have dissipated.
7. Never make adjustments when engine is running (unless recommended by manufacturer).

Operation

1. Do not put hands or feet near or under rotating parts. Do not allow hands or any other part of the body or clothing near the rotating tines or near any other moving part. The tines begin to rotate forward

once the engine starts, the Tines/PTO Clutch Lever is in the ENGAGE position, the Forward Interlock Levers are squeezed closed and the Wheels/Tines/PTO Drive Lever is shifted to FORWARD. The tines rotate in Reverse whether the Interlock Levers are closed or open.

2. Exercise extreme caution when on or crossing gravel drives, walks, or roads. Stay alert for hidden hazards or traffic. Do not carry passengers.
3. After striking a foreign object, stop the engine, remove the wire from the spark plug wire and prevent it from touching the spark plug. Thoroughly inspect the machine for any damage and repair the damage before restarting and operating the machine.
4. Exercise caution to avoid slipping or falling.
5. If the unit should start to vibrate abnormally, stop the engine, disconnect the spark plug wire and prevent it from touching the spark plug, and check immediately for the cause. Vibration is generally a warning of trouble.
6. Stop the engine, disconnect the spark plug wire and prevent it from touching the spark plug whenever you leave the operating position, before unclogging the tines, or when making any repairs, adjustments or inspections.

7. Take all possible precautions when leaving machine unattended. Stop engine. Disconnect spark plug wire and move it away from spark plug. Remove ignition key on electric start models

Section 1: Safety

8. Before cleaning, repairing, or inspecting, stop the engine and make certain all moving parts have stopped. Disconnect the spark plug wire and prevent it from touching the spark plug to prevent accidental starting.

9. The flap on the tine hood must be down when operating the tiller, unless using the Hiller/Furrower attachment.

10. Never use the tiller unless proper guards, plates, or other safety protective devices are in place.

11. Do not run engine in an enclosed area. Engine exhaust contains carbon monoxide gas, a deadly poison that is odorless, colorless, and tasteless.

12. Keep children and pets away.

13. Never operate the tiller under engine power if the Wheel Speed Lever is in the FREEWHEEL position. In FREEWHEEL, the wheels will not hold the tiller back and the revolving tines could propel the tiller rapidly, possibly causing loss of control. Always engage the Wheel Speed Lever in either FAST or SLOW position before starting the engine or engaging the tines with the Wheels/Tines/PTO Drive Lever.

14. **Be aware that the tiller may unexpectedly bounce upward or jump forward if the tines should strike extremely hard packed soil, frozen ground, or buried obstacles like large stones, roots, or stumps. If in doubt about the tilling conditions, always use the following operating precautions to assist you in maintaining control of the tiller:**

- a. **Walk behind and to one side of the tiller, using one hand on the handlebars. Relax your arm, but use a secure hand grip.**
- b. **Use shallower depth regulator settings, working gradually deeper with each pass.**
- c. **Use slower wheel, tine and engine speeds.**
- d. **Clear the tilling area of all large stones, roots and other debris.**
- e. **Avoid using downward pressure on handlebars. If need be, use slight upward pressure to keep the tines from digging too deeply.**

f. **Before contacting hard packed soil at the end of a row, reduce engine speed and lift handlebars to raise tines out of the soil.**

g. **In an emergency, stop tines and wheels by shifting the Wheels/Tines/PTO Drive Lever into NEUTRAL. If you can not reach the lever or have lost control of the tiller, let go of the handlebars and all controls. Do not attempt to restrain the tiller.**

15. Do not overload the tiller's capacity by attempting to till too deeply at too fast a rate.

16. Never operate the tiller at high transport speeds on hard or slippery surfaces. Look behind and use care when backing up.

17. Do not operate the tiller on a slope that is too steep for safety. When on slopes, slow down and make sure you have good footing. Never permit the tiller to freewheel down slopes.

18. Never allow bystanders near the unit.

19. Only use attachments and accessories that are approved by the manufacturer of the tiller.

20. Use tiller attachments and accessories when recommended.

21. Never operate the tiller without good visibility or light.

22. Never operate the tiller if you are tired, or under the influence of alcohol, drugs or medication.

23. Operators shall not tamper with the engine-governor settings on the machine; the governor controls the maximum safe operating speed to protect the engine and all moving parts from damage caused by overspeed. Authorized service shall be sought if a problem exists.

24. Do not touch engine parts which may be hot from operation. Let parts cool down sufficiently.

25. **POISON/DANGER—CAUSES SEVERE BURNS.** The battery on electric start models contains sulfuric acid. Avoid contact with skin, eyes or clothing. Keep out of reach of children.

Antidotes:

External— Flush immediately with lots of water.

Internal— Drink large quantities of water or milk. Follow with milk of magnesia, beaten eggs or vegetable oil. Call a doctor immediately.

Eyes— Flush with water for 15 minutes. Get prompt medical attention.

26. **DANGER— BATTERIES PRODUCE EXPLOSIVE GASES.** Keep sparks, flame or smoking materials away. Ventilate when charging battery or using in an enclosed space. Always wear safety goggles when working near battery.

27. Please remember: You can always stop the tines and wheels by releasing all controls, or by moving the ignition switch and/or throttle control lever on the engine to OFF or STOP.

28. To load or unload the tiller, see the instructions in Section 4 of this Manual.

29. Use extreme caution when backing or pulling the machine towards you.

30. Start the engine carefully according to instructions and with feet well away from the tines.

31. Never pick up or carry a machine while the engine is running.

32. When loading or unloading the tiller, always disengage tines and use slower wheel and engine throttle speeds. Use sturdy ramps wide and strong enough to easily support the tiller (280-to-325 lbs., depending on model) and operator. Never go down ramps in FORWARD drive—the tiller could tip forward, exposing you to the tines (which should be disengaged). Always use REVERSE drive and back down ramps. To go up ramps, use FORWARD drive and follow the tiller.

33. The Forward Interlock Safety System should be tested for correct functioning every time the tiller or PTO power unit is used. See Section 4 in this Manual.

34. If using the optional Dozer Blade, either remove the tine attachment, or disengage the tines with the Tines/PTO Clutch Lever. Revolving tines are dangerous.

Maintenance and Storage

1. Keep the tiller, attachments and accessories in safe working condition.
2. Check all nuts, bolts, and screws at frequent intervals for proper tightness to be sure the equipment is in safe working condition.
3. Never store the tiller with fuel in the fuel tank inside a building where ignition sources are present such as hot water and space heaters, furnaces, clothes dryers, stoves, electric motors, etc.). Allow engine to cool before storing in any enclosure.

4. To reduce the chances of a fire hazard, keep the engine free of grass, leaves, or excessive grease.
5. Store gasoline in a cool, well-ventilated area, safely away from any spark- or flame-producing equipment. Store gasoline in an approved container, safely away from the reach of children.
6. Refer to the Maintenance sections of this Manual and the separate Engine Owner's Manual for instructions if the tiller is to be stored for an extended period.

7. Never perform maintenance while the engine is running or the spark plug wire is connected, except when specifically instructed to do so.
8. If the fuel tank has to be drained, do this outdoors.

Decals

For your safety and the safety of others, various safety and operational decals are located on your unit (Figure 1).

Keep the decals clean and legible at all times. Contact your local service dealer or the Factory for replacements if any decals are damaged or missing.

Refer to the Parts List for decal locations, descriptions and part numbers.

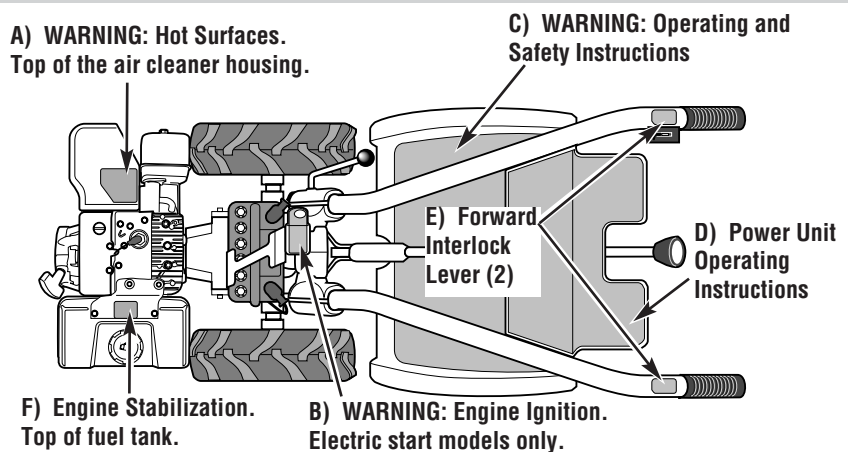

Figure 1: Location of Safety and Operating Decals.
(Briggs & Stratton engine shown)

Operating Symbols

Various symbols (shown here, with word descriptions) are used on the tiller and engine. Your unit may not have all of the symbols.



FAST



SLOW



STOP



CHOKE
ON



CHOKE
OFF



ROTATING
TINES



WARNING

TO AVOID SERIOUS INJURY:

- READ THE OWNER'S MANUAL.
- KNOW LOCATIONS AND FUNCTIONS OF ALL CONTROLS.
- KEEP ALL SAFETY DEVICES AND SHIELDS IN PLACE AND WORKING.
- NEVER ALLOW CHILDREN OR UNINSTRUCTED ADULTS TO OPERATE TILLER.
- SHUT OFF ENGINE AND DISCONNECT SPARK PLUG WIRE BEFORE MANUALLY UNCLOGGING TINES OR MAKING REPAIRS.
- KEEP BYSTANDERS AWAY FROM MACHINE.
- KEEP AWAY FROM ROTATING PARTS.
- USE EXTREME CAUTION WHEN REVERSING OR PULLING THE MACHINE TOWARDS YOU.

Section 2 Assembly

⚠ WARNING

To prevent personal injury or property damage, do not start the engine until all assembly steps are complete and you have read and understand the safety and operating instructions in this manual.

Introduction

Carefully follow these assembly steps to correctly prepare your tiller for use. It is recommended that you read this Section in its entirety before beginning assembly.

NOTE: Three different Horse model tillers are covered in this Manual. Use only the information applicable to your model.

Tiller engines vary by model. Your engine may appear differently than those found in illustrations of this manual.

Inspect Unit

Inspect the unit and carton for damage immediately after delivery. Contact the carrier (trucking company) if you find or suspect damage. Inform them of the damage and request instructions for filing a claim. To protect your rights, put your claim in writing and mail a copy to the carrier within 15 days after the unit has been delivered. Contact us at the Factory if you need assistance in this matter.

STEP 1: Unpacking Instructions

NOTE: Do not severely bend any of the control cables on the unit.

1. The tiller is heavy. Do not attempt to remove it from the shipping platform until instructed to do so in these *Assembly* steps.
2. Remove all unassembled parts from the carton. The hardware bag is included in your literature packaging.
3. Check that you have the items listed below (contact your local dealer or the

Factory if any items are missing or damaged).

NOTE: Use the screw length template (Figure 2-1) to identify screws.

Loose Parts List

Qty.	Description
1	Handlebar Assembly
1	Wheels/Tines PTO Drive Lever
<i>The following items are in the hardware bag:</i>	
2	20 oz. Bottles SAE 30W Oil
1	Clutch Pawl Spring
1	Belt Adjusting Tool
2	Plastic Cable Ties
1	Curved Head Screw, 1/4-20 x 2
1	Flanged Lock Nut, 1/4-20
1	Pan Head Screw, #10-32 x 1/2

The following parts (electric start models only), packaged separately.

- 2 Nuts, 1/4-20
(for battery terminals)
- 2 Screws, 1/4-20 x 5/8
(for battery terminals)
- 2 Keys
(in ignition switch)

NOTE: LEFT and RIGHT sides of the tiller are as viewed from the operator's position behind the handlebars (unless otherwise noted).

Tools/Materials Needed for Assembly

- (1) 3/8" open-end wrench*
 - (2) 7/16" open-end wrench*
 - (2) 1/2" open-end wrench*
 - (1) 9/16" open-end wrench*
 - (1) 3/4" open-end wrench*
 - (1) Flat blade screwdriver
 - (1) Scissors (to trim plastic ties)
 - (1) Tire pressure gauge
 - (1) 4-1/2" high wood block to prop unit
- * Adjustable wrenches may be used.

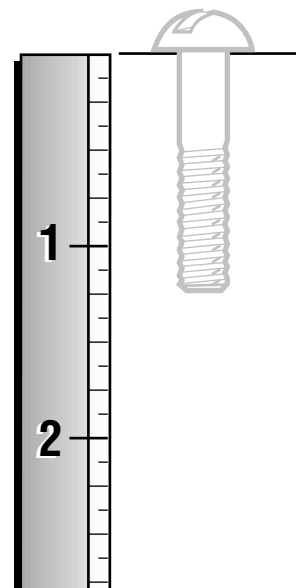

Figure 2-1: To identify length of screw, place screw on template as shown and measure distance between bottom of screw head and tip of screw.

STEP 2: Attach Handlebar

IMPORTANT: When disassembling handlebar assembly, keep left-side clamp and ratchet separated from the right-side clamp and ratchet.

1. Disassemble the handlebar assembly. To do this, remove the height adjustment lever by turning the lever in a counter-clockwise direction (Figure 2-2).
2. Place the handlebar ends on either side of the base, with the wire harness toward the rear of the base (Figure 2-2).
3. Install the height adjustment lever through the right-side clamp, handlebar end, ratchet, and base; then out through the left-side ratchet, handlebar end, and clamp (Figure 2-2). Secure with nut, but don't fully tighten.

IMPORTANT: Do not force the height adjustment lever through the handlebars. The interlock wires may be blocking the

lever and could be damaged. You may gently move the wires aside if this condition occurs.

4. Raise handlebars to one of two height settings and tighten the height adjustment lever. Also, make sure all other mounting hardware is securely tightened.

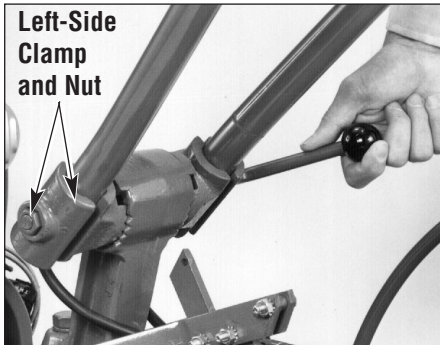

Figure 2-3. Fully assembled handlebars.

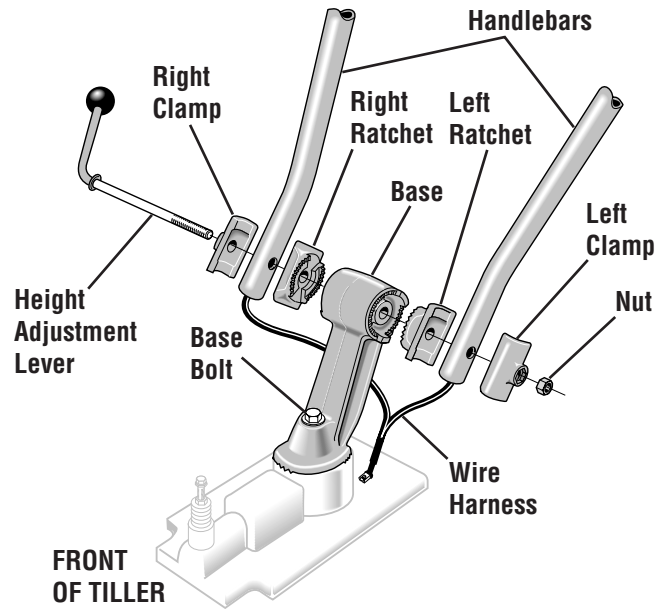

Figure 2-2. Handlebar assembly.

NOTE: Fully assembled handlebar assembly should appear as shown in Figure 2-3.

STEP 3: Move Tiller Off Shipping Platform

1. Set the Depth Regulator Lever (A, Figure 2-4) to Travel position. Do this by lifting the tiller by the handlebars, then pulling straight back on the lever and sliding down to the highest notched setting.

2. Set the Wheel Speed Lever (B, Figure 2-4) to Freewheel position. To do this, move the lever approximately halfway between the Fast and Slow settings while you rock the tiller forward and backward until the wheels move freely.

3. Lift Handlebars high enough to clear tiller tines and pull back firmly to dislodge the tiller from the platform wheel wells.

STEP 4: Connect Forward Interlock Wire Harness

1. Remove any dirt from the Forward Interlock wire harness plug (C, Figure 2-5) and its receptacle (D).

2. Connect the Forward Interlock wire harness plug (C, Figure 2-5) to the receptacle (D).

STEP 5: Attach Wheels/Tines/PTO Drive Lever

1. Loosen the bolt (Figure 2-2) on the

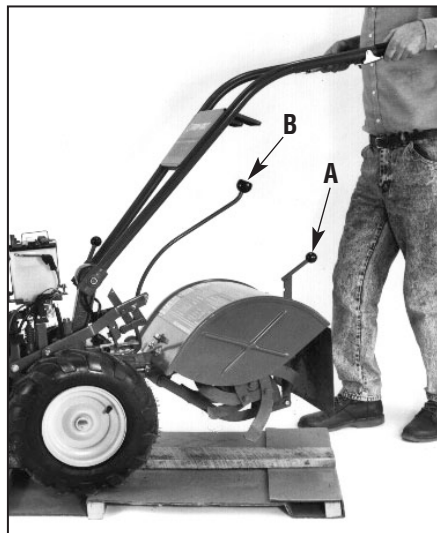

Figure 2-4: Photo shows the Depth Regulator Lever (A) and the Wheel Speed Lever (B).

handlebar base and swing the handlebars out to the right side.

2. Remove both sets of nuts, star washers, screws, and one bushing (A, B, C, D, E, F, G, Figure 2-6) from the yoke plates (H). There is a bushing inside the short link (I). Be careful not to lose it when removing screw (G).

3. Slide the plates at the end of the Wheels/Tines/PTO Lever over the yoke plates (Figure 2-9). To aid in the next step, insert a screw temporarily into the forward most holes (J, Figure 2-7) of the

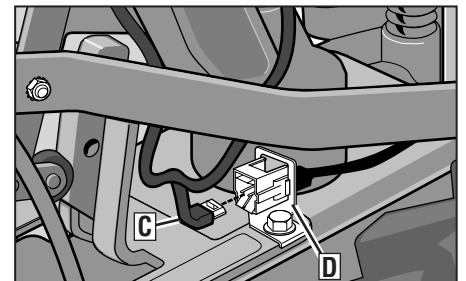

Figure 2-5. Forward Interlock Wire Harness connection.

yoke plates and the lever.

4. Align the rear most holes of the yoke plates and the Wheels/Tines/PTO Lever. Use long nose pliers to hold the bushing (L, Figure 27) in place while inserting the screw (K) through the lever and yoke plates. Install star washer (B, Figure 2-6) and nut (A), then hand tighten.

5. Retrieve the clutch pawl spring (Figure 2-8) from hardware bag.

Section 2: Assembly

Remove the temporary screw (J, Figure 2-7) from the forward holes and move the Wheels/Tines/PTO Lever fully forward. Install the wider hook end of the clutch pawl spring (M, Figure 2-8) down into the small hole at the end of the handle. Use pliers to insert the other end into the hole in the long link bar (N).

NOTE: Do not bend or over stretch the spring while installing.

6. Pull the Wheels/Tines/PTO Lever back to align the forward most holes (Q, Figure 2-9) in the yoke plate with the holes in the lever plates. Also align the bushing that is inside the short link bar (P). Install the screw, star washer, and nut, then tighten securely.

Securely tighten all other hardware (Q, R, Figure 2-9). Also ensure that the spring (S) is properly seated at both ends.

Completed assembly should appear as illustrated in Figure 2-9.

7. Test the operation of the Wheels/Tines/PTO Lever. Push the lever down until it engages in the Forward position. The clutch roller (T, Figure 2-10) must rest beneath the adjustment block (U). Next, move the lever up to the Neutral position. The clutch roller (T, Figure 2-11) should rest on the face of the adjustment block (U). To test Reverse, lift and hold the lever all the way up in Reverse position, then let it go. The lever should automatically return to the Neutral position (Figure 2-11). If not, do not use the tiller. See your local authorized dealer or call the Factory Technical Service Department for instructions.

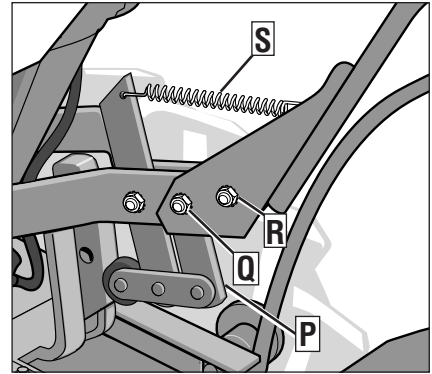

Figure 2-9: Fully assembled Wheels/Tines/PTO Lever assembly.

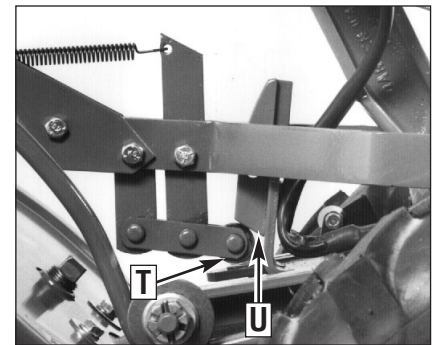

Figure 2-10 Forward position; roller (T) rests under the adjustment block (U).

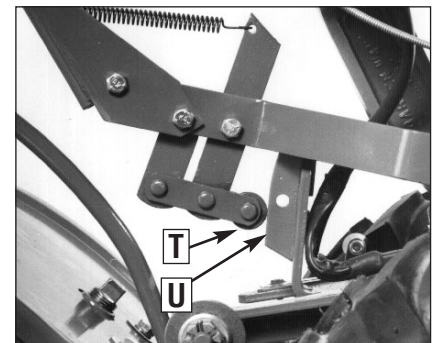

Figure 2-11: Neutral position; roller (T) rests against middle area of the adjustment block (U).

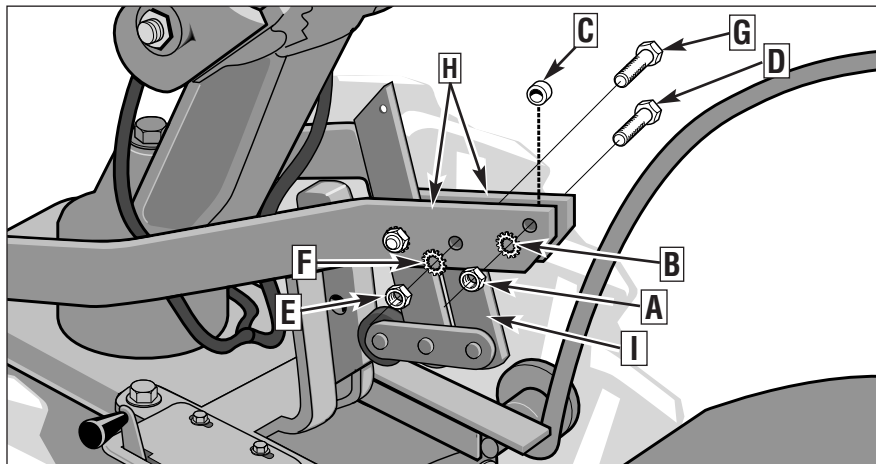

Figure 2-6: Illustration shows the yoke plates (H), nuts, washers, and screws (A, E, B, F, D, G), bushing (C), and long and short links (I, J).

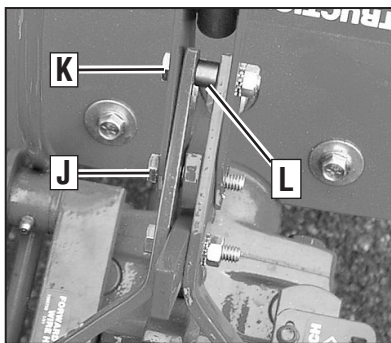

Figure 2-7: Drive Lever assembly.

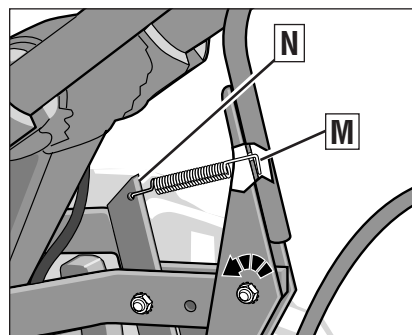

Figure 2-8: Clutch pawl spring. Tilt Wheels/Tines/PTO Lever fully forward before installing spring.

STEP 6: Check Gear Oil Levels

Your tiller has two separate transmissions: one for the Power Unit (Figure 2-12), the other for the Tine Attachment (Figure 2-13). Both transmissions were filled at the factory with SAE #85W-140 weight gear oil (with an A.P.I rating of GL-4). Check level in both transmissions to verify that they are still correct. See Section 5, *Transmission Gear Oil Maintenance* for complete information on how to check and fill the transmissions.

IMPORTANT: Check gear oil level in both transmissions after the first 2 hours of new tiller operation, then every 30 operating hours thereafter. See Section 5 for instructions.

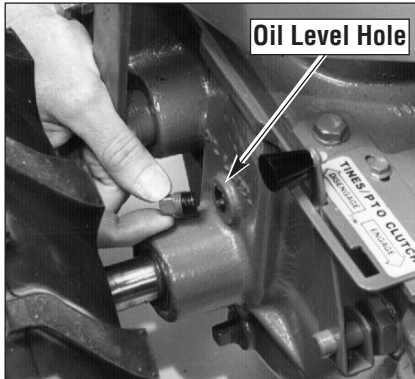

Figure 2-12: Checking oil level on Power Unit Transmission.

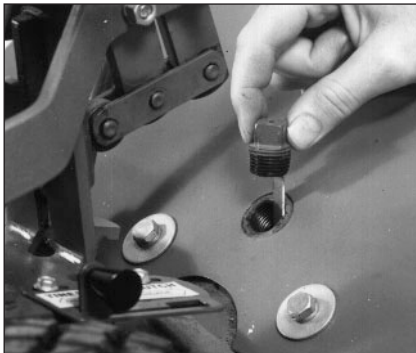

Figure 2-13: Checking oil level on Tine Attachment Transmission.

STEP 7: Add Motor Oil to Engine

1. Before adding motor oil, park the tiller on level ground. Level the engine by placing a sturdy block under the tines or the tines depth regulator bar.
2. Refer to the Engine Owner's Manual provided with your tiller for detailed information on how to add motor oil and for motor oil specifications.

IMPORTANT: Two 20 oz. bottles of motor oil are included with your tiller. Check the oil level as instructed in the Engine Owner's Manual provided with your tiller BEFORE pouring the full amount of each bottle into the engine.

IMPORTANT:

- Change engine oil after first 2 hours of new operation.
- Check engine oil level every 5 hours of operation or each use.

STEP 8: Attach Engine Throttle Lever and Cable

For shipping purposes, the throttle cable, together with the throttle lever, is wound around the engine. Carefully unwind the cable. If the throttle control label is covered with a clear protective coating, peel it off.

⚠ WARNING

To avoid electric shock from a short circuit (electric start tillers only), never allow the throttle cable to touch the battery. Route cable below the battery, on the outside of the battery holder.

To attach the throttle lever and cable:

1. Run the throttle cable up the inside edge of the right handlebar and position the lever as shown in Figure 2-14.
2. From the outside of the handlebar, insert the curved head screw (A, Figure 2-14), through the handlebar and the center hole in the throttle lever mounting bracket.
3. Loosely install the flanged lock nut and move the throttle lever back to the STOP position.
4. From the lever side of the bracket, thread a pan head screw (B, Figure 2-14) through the small hole in the throttle lever bracket and into the handlebar. Tighten the screw securely.
5. Securely tighten both the flanged lock nut and the curved head screw.
6. Use two plastic ties to secure the throttle cable to the right handlebar in two places (Figure 2-15). Loop each tie around the handlebar and cable (serrated side faces in) and pull the ties tight. Trim the ends.

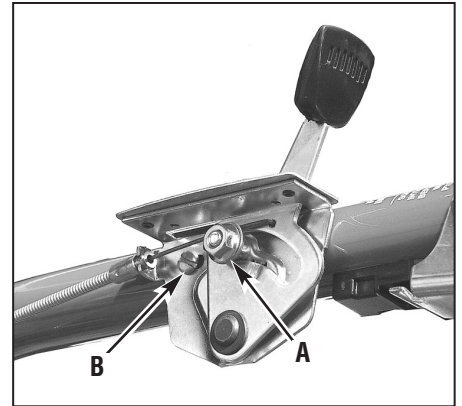

Figure 2-14: Engine Throttle Lever position and installation.

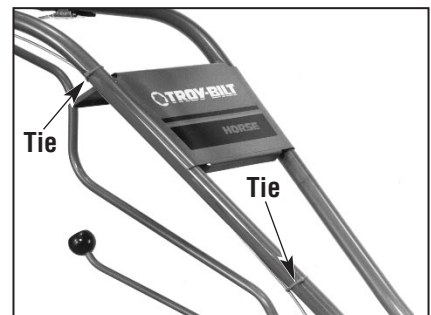

Figure 2-15: Plastic Ties placement on handlebars.

STEP 9: Adjust Air Pressure in Tires

For shipping purposes, the tires may be overinflated. Check the air pressure in each tire and adjust them to between 10 and 20 pounds per square inch. You must inflate each tire to equal air pressures to prevent the tiller from pulling to one side.

Assembly is complete for recoil start tillers. See *Assembling The Electric Start System* if you own an electric start tiller; otherwise, refer to Section 3, *Controls* for information on tiller controls.

Section 2: Assembly

ASSEMBLING THE ELECTRIC START SYSTEM

The following steps explain how to install and charge the battery on electric start tillers. For your safety, follow all steps and observe all accompanying safety messages. Section 5 contains other general battery maintenance and recharging instructions.

⚠ DANGER

Battery produces explosive gases.

- Keep away sparks, flames, and cigarettes.
- Ventilate area when charging or using battery in an enclosed space.
- Make sure battery vent tube is always open after battery is filled with acid.

⚠ WARNING

Remove metal jewelry before working near the battery or near the electrical system. Failure to comply may cause a short circuit, resulting in electrical burns, a shock, or battery gas explosion.

NOTE: If the battery is put into service after the date shown on the top of the battery, charge for a minimum of one hour at 6-10 amps. Refer to the Maintenance section of this manual for more detailed instructions regarding proper battery charging procedure

1. Use a 5/8" long screw (K, Figure 2-18) and 1/4-20 hex nut (L) to connect the positive (+) battery cable (B) to the positive (marked +) battery post (C). Make sure that this is the cable on the left side, with one end attached to the solenoid (D).
2. Slide the black rubber boot (E) completely over the battery post and cable connector.
3. Use a 5/8" long screw and 1/4-20 hex nut to connect the negative (-) battery cable (F) to the negative (marked -) battery post (G) and secure with screw (H) and nut (I).
4. Slide the black rubber boot (J) completely over the battery post and cable connector.

Assembly is complete for electric start tillers. See Section 3, *Controls* for information on tiller controls.

⚠ DANGER

To Avoid Personal Injury or Property Damage:

- Do not touch positive battery terminal and any surrounding metal objects with tools, jewelry or other metal items. Failure to comply could cause a short circuit leading to electrical burns or explosion of battery gases.
- Never bring a gas can near the positive (+) battery terminal. A short circuit could occur leading to an explosion of the gasoline or the battery gases. Always fill the engine fuel tank from the front or side of the engine.

⚠ DANGER

Never jump start the battery with a vehicle battery or charging system. This may produce a battery explosion, causing acid or electrical burns.

STEP 1: Connect the Wire Harness Receptacle

1. Before installing the battery and its hold-down clamp, insert the plastic wire harness receptacle (A, Figure 2-18) into the prongs of the keyswitch (M) located on the hold-down clamp.

2. Remove the ignition keys from the keyswitch and store them safely away. Do not insert the key into the keyswitch until you complete this section and read Section 3, *Controls*.

STEP 2: Install the Battery Cables

NOTE: The cable terminals should be toward the rear (keyswitch side) of the battery posts.

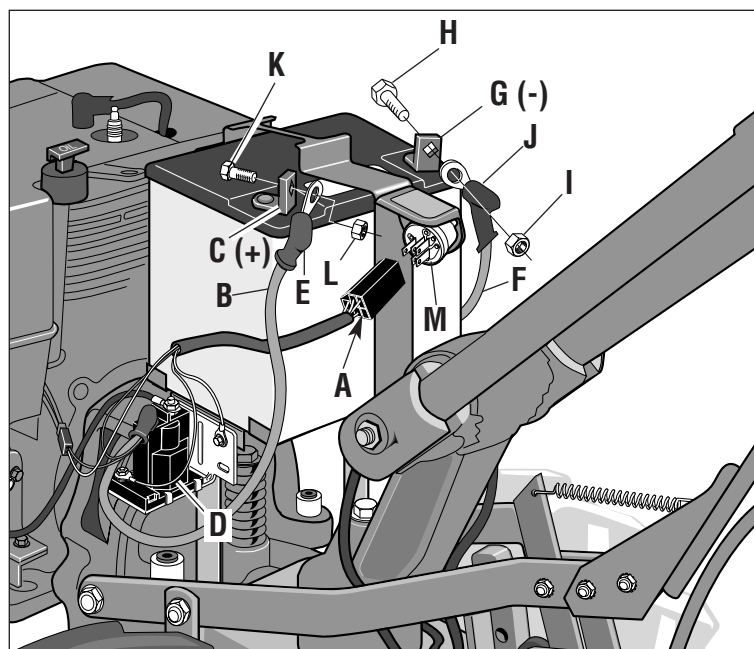

Figure 2-18: Battery cable assembly.

Section 3 Features and Controls

⚠ WARNING

Before operating your machine, carefully read and understand all safety, controls, operating instructions in this Manual, the separate Engine Owner's Manual and on the decals on the machine.

Failure to follow these instructions can result in serious personal injury.

Introduction

This section describes the location and function of the controls and features on your tiller. Refer to Section 4, *Operation* for detailed operating instructions.

Practice using these controls, with the engine shut off, until you completely understand the operation of the controls and feel confident with each of them.

IMPORTANT: Refer to the separate engine manufacturer's Engine Owner's Manual for information about the controls on the engine.

NOTE: All references to left, right, front and rear of the machine are based on a position behind the handlebars and facing forward.

PTO Attachments Feature

In addition to powerful tilling capability, you can quickly convert your machine into a PTO (Power Take-Off) Power Unit that is capable of towing or powering various TROY-BILT attachments.

You can access this capability by removing the tines attachment (powered by the PTO Power Unit). The PTO Power Unit is then available for engine powered attachments, or for pulling or towing non-powered attachments. See Section 4, *PTO Power Unit* for detailed information on installing and operating TROY-BILT PTO attachments.

Wheels/Tines/PTO Drive Lever

Use the Wheels/Tines/PTO Drive Lever (A, Figure 3-1) to engage and disengage power to the transmission.

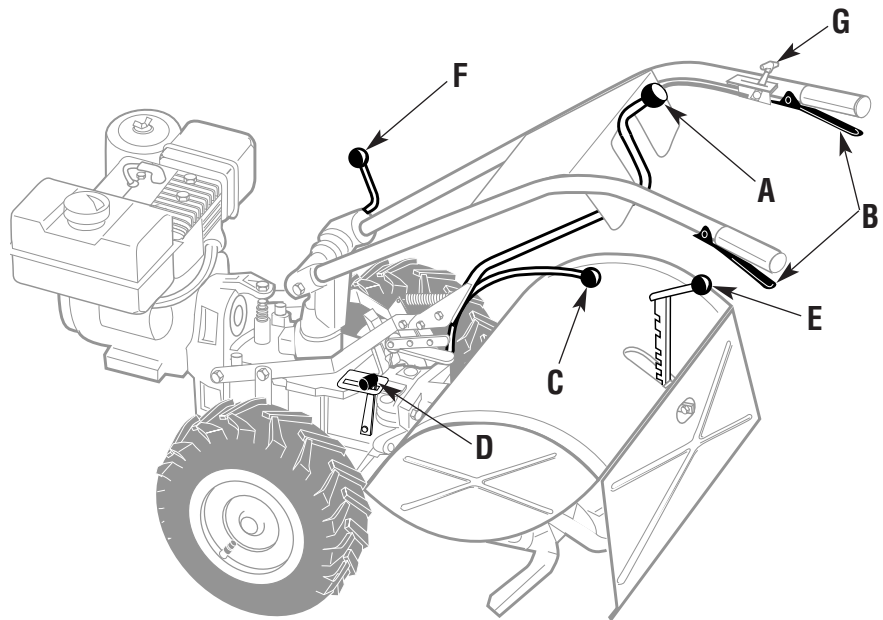

Figure 3-1:

A– Wheels/Tines/PTO Drive Lever
B– Forward Interlock Levers
C– Wheel Speed Lever
D– Tines/PTO Clutch Lever

E– Depth Regulator Lever
F– Handlebar Height Adjustment Lever
G– Engine Throttle Lever

This lever has three operating positions: FORWARD, NEUTRAL and REVERSE.

- FORWARD is engaged when the lever is moved down until the clutch roller (G, Figure 3-2) engages into the detent position under the adjustment block (H, Figure 3-2). You will definitely feel the lever engage into this position.

Use the FORWARD setting to move the wheels and tines forward, or to apply power to an optional PTO (Power Take Off) attachment. (See also *Forward Interlock Levers*.)

To stop the wheels, tines or any PTO attachment, move the lever to NEUTRAL by tapping the lever upwards (Figure 3-3) and releasing.

- REVERSE is engaged when the lever is pushed (with an open palm) all the way up and held in that position (Figure 3-4). Use this setting to move the wheels in reverse. To stop moving in reverse, release the lever; it automatically returns to the NEUTRAL position.

IMPORTANT: Do not operate the tines or any PTO attachment in REVERSE.

- NEUTRAL is this control's normal non-operating position. The lever returns to NEUTRAL when it is tapped out of the FORWARD position or released from the REVERSE position. NEUTRAL position is between FORWARD and REVERSE (Figure 3-3). Use this setting to stop the wheels, tines or any PTO attachment.

IMPORTANT: Always shift to NEUTRAL before starting the engine or before engaging the wheels, tines or any PTO attachment.

Forward Interlock Levers

The Forward Interlock Levers (B, Figure 3-1) are attached under each handlebar grip.

You must squeeze at least one of these interlock levers up against the handlebar grip whenever the Wheels/Tines/PTO Drive Lever is engaged in FORWARD position.

Section 3: Features and Controls

Verify Position of Clutch Roller

When you shift between FORWARD, NEUTRAL and REVERSE, the clutch roller at the base of the Wheels/Tines/PTO Drive Lever should be positioned as shown in Figures 3-2, 3-3 and 3-4. Verify the position of the clutch roller as you shift the lever. If it is not positioned correctly, contact the Factory or see your local authorized dealer.

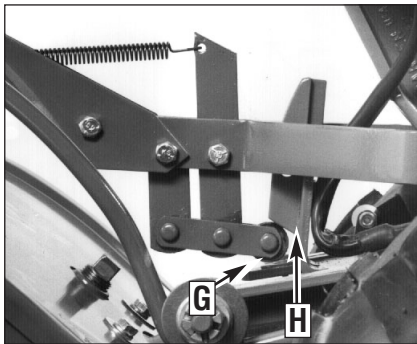

Figure 3-2: FORWARD position; roller (G) rests under the adjustment block (H).

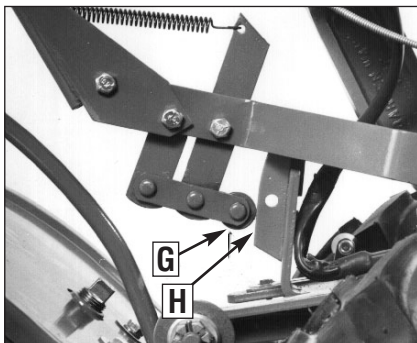

Figure 3-3: NEUTRAL position; roller (G) rests against middle area of the adjustment block (H).

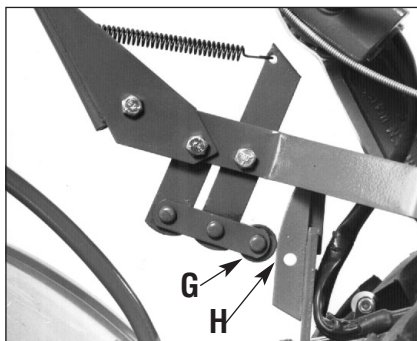

Figure 3-4: REVERSE position; roller (G) rests against upper area of the adjustment block (H).

If both Forward Interlock Levers are released before first returning the Wheels/Tines/PTO Drive Lever to NEUTRAL, the engine will stop.

IMPORTANT: The Forward Interlock Levers are a safety control that stops the engine should you lose control while going forward and cannot shift into NEUTRAL.

Wheel Speed Lever

Use the Wheel Speed Lever (C, Fig. 3-1) to select one of three operating positions: SLOW, FAST or FREEWHEEL.

- SLOW – Lever moved all the way down. Most effective for normal tilling or for low-speed transport.
- FAST – Lever moved all the way up. Most effective for cultivating or for fast-speed transport.
- FREEWHEEL – Lever in between SLOW and FAST (wheels will roll freely). Used when transporting the machine on level ground without engine power, and when using stationary PTO attachments.

IMPORTANT: To avoid transmission damage, always move Wheels/Tines/PTO Drive Lever into NEUTRAL before shifting the Wheel Speed Lever.

IMPORTANT: When shifting into SLOW or FAST, gently roll the machine forward or backward to help fully engage the wheel gears. When engaged, the wheels will not turn unless the engine is running and the Wheels/Tines/PTO Drive Lever is engaged in FORWARD or REVERSE.

Tines/PTO Clutch Lever

Use this lever (D, Figure 3-1) to engage or disengage power from the transmission PTO clutch to the tines or any PTO attachment. This control has two operating positions: ENGAGE and DISENGAGE.

- ENGAGE – Lever moved into detent slot farthest from engine. Use this position to operate tines or other PTO attachments. After shifting to ENGAGE, briefly operate machine in FORWARD to help fully engage the PTO clutch.
- DISENGAGE – Lever moved into detent slot nearest engine. Use this position to disengage power to tines or other PTO attachments before transporting, loading, turning, or operating in reverse.

IMPORTANT: To avoid transmission damage, always move the Wheels/Tines/PTO Drive Lever into NEUTRAL before shifting the Tines/PTO Clutch Lever.

Depth Regulator Lever

Use this lever (E, Figure 3-1) to regulate the tilling depth of the tines. This control also has a TRAVEL position, which enables transport with the tines off the ground.

To operate the lever, lift up on the handlebars, pull the Depth Regulator Lever straight back, and then slide it up or down to one of the eight detent height settings.

The eight detent positions offer a range of tine height settings. This enables you to select the height that is most effective for a particular condition. The top detent position is the TRAVEL setting. Use the second or third detent from the top for shallow tilling and cultivating. Use the other detents for deeper tilling and for power composting.

WARNING

To avoid personal injury, always place the tines in the TRAVEL position before starting the engine. This prevents the tines from touching the ground until you are ready to begin tilling.

Handlebar Height Adjustment Lever

Use this lever (F, Figure 3-1) to adjust the handlebars to one of two height settings.

1. To change the height, hold the handlebars with one hand and loosen the lever in a counterclockwise direction.
2. Move the handlebars to one of the two preset height settings.
3. Retighten the lever.

NOTE: You can swap the positions of the inside handlebar ratchets to change the two preset settings by approximately four inches higher or lower. See Section 2, *Step 2: Attach Handlebar* for detailed assembly information.

⚠ WARNING

The tiller handlebars can be swung out 30° to the right side for use only with the PTO Chipper/Shredder attachment. This is done by loosening the mounting bolt on the handlebar base. Never operate your tiller or attachments, other than the PTO Chipper/Shredder, with the handlebars in the right side position. Doing so could result in unsafe handling and personal injury.

Engine Throttle Lever

Use the throttle lever (G, Figure 3-1) to adjust engine speed as well as to start and stop the engine.

Move the lever away from the STOP position before starting the engine. Engine speeds are variable and range between the FAST and SLOW. Use the STOP position to turn the engine off.

NOTE: A secondary throttle lever is located on the front of the 8HP and 10HP engines. A separate On/Off switch may also be available on the engine. (See Engine Owner's Manual for information.)

Keyswitch Starter

The keyswitch starter on electric start models (A, Figure 3-5) has three positions: OFF, RUN and START. Turn the key to START to start the engine.

Release the key and it will return to the RUN position. Turn the key to OFF to stop the engine. (Another way to stop the engine is to move the engine throttle lever to the STOP position.)

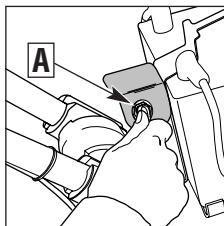

Figure 3-5

Engine Controls

Refer to the engine manufacturer's Engine Owner's Manual (included in the tiller literature package) to identify the controls on your engine.

IMPORTANT: An engine On/Off switch, a secondary throttle control, a choke lever and a fuel line shut-off control may be located on the engine. Refer to your Engine Owner's Manual for detailed information.

⚠ WARNING

To avoid serious personal injury or damage to equipment, do not start your engine at this time. Complete starting instructions are described in Section 4, Operation.

Section 4 Operation

⚠ WARNING

Before operating your machine, carefully read and understand all safety (Section 1), controls (Section 3) and operating instructions (Section 4) in this Manual, in the separate Engine Owner's Manual, and on the decals on the machine.

Failure to follow these instructions can result in serious personal injury.

INTRODUCTION

Read this Section of the manual thoroughly before you start the engine. Then, take the time to familiarize yourself with the basic operation of the tiller before using it in your garden. Find an open, level area and practice using the tiller controls without the tines engaging the soil (put tines in Travel setting—Section 3, *Depth Regulator Lever*). Only after you've become completely familiar with the tiller should you begin using it in the garden.

⚠ WARNING

Your tiller and its optional PTO Power Unit attachments are capable of causing serious injury to untrained or careless operators.

To avoid serious personal injury or property damage, read the Owner's Manual that is provided with any optional accessories or attachments before using the tiller or PTO Power Unit.

Break-In Operation

Perform the following maintenance during the first hours of new operation (see *Maintenance* Section in this Manual and maintenance information in the Engine Owner's Manual).

1. Change engine oil after first 2 hours of new engine operation.



Figure: 4-1

2. After the first 2 hours of new operation, check the gear oil levels in the PTO Power Unit and the tine attachment transmissions.
3. Check for loose or missing hardware on unit. Tighten or replace as needed.
4. Check tension on forward drive belt after first 2 hours of operation.

Starting and Stopping the Engine

The following steps describe how to start and stop the engine.

IMPORTANT: Do not attempt to engage the tines, wheels, or any PTO attachment until you have read all of the operating instructions in this Section. Also review the safety rules in Section 1, *Safety* and the tiller and engine controls information in Section 3, *Features and Controls*.

Pre-Start Checklist

Make the following checks and perform the following services *before* starting the engine.

1. Read the *Safety* and *Controls* Sections in this Manual. Read the separate Engine Owner's Manual provided by the engine manufacturer.

2. Check unit for loose or missing hardware. Service as required.
3. Check engine oil level. See Engine Owner's Manual.
4. Shift the Wheels/Tines/PTO Drive lever (Figure 4-2) into NEUTRAL position. See Section 3, *Controls* for more information on this lever.
5. Check Safety Guards. All guards and covers must be securely in place.
6. Check air cleaner. See Engine Owner's Manual.
7. Attach spark plug wire to spark plug.
8. Check Engine Cooling System. Clear cooling fins and air intake screen of debris.
9. Select High/Low Belt Speed range.
10. Adjust Handlebar Height.
11. Fill the fuel tank with gasoline in accordance with the directions in the separate Engine Owner's Manual. Follow all instructions and safety rules carefully.

⚠ DANGER

GASOLINE IS HIGHLY FLAMMABLE AND ITS VAPORS ARE EXPLOSIVE.

Follow gasoline safety rules in this Manual (Section 1) and in the separate Engine Owner's Manual.

Failure to follow gasoline safety instructions can result in serious personal injury and property damage.

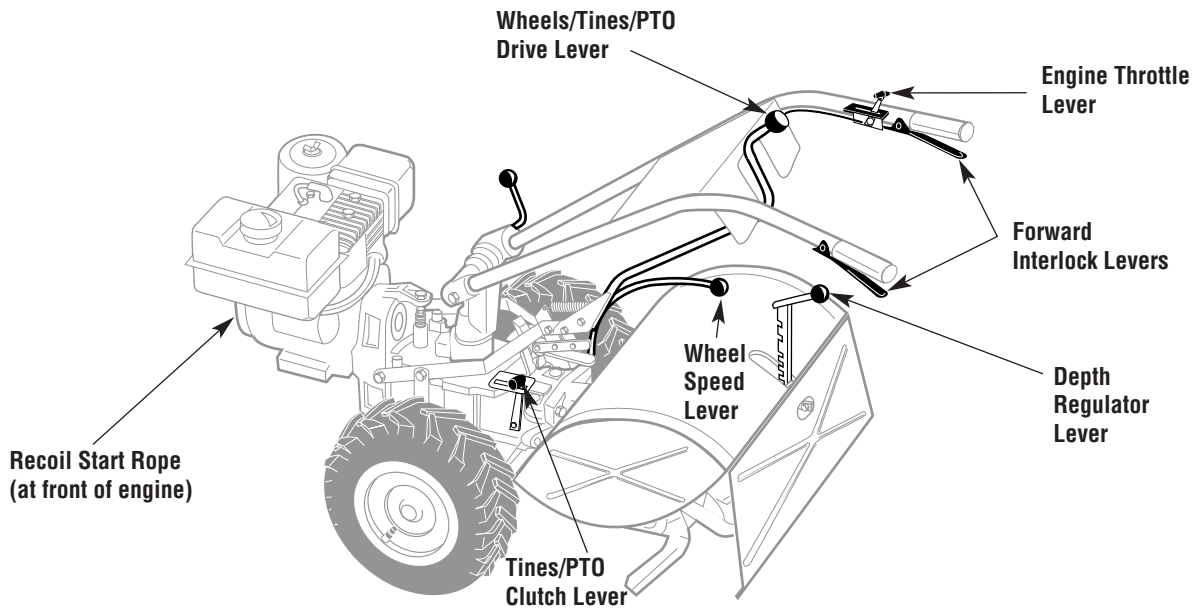

Figure 4-2: Tiller and engine controls.

Starting the Engine:

CAUTION

To help prevent serious personal injury or damage to equipment:

- Always place **Wheels/Tines/PTO Drive Lever** into **NEUTRAL** before starting engine, and before engaging wheels, tines or other PTO-driven attachments.
- Never run engine indoors or in enclosed, poorly ventilated areas. Engine exhaust contains carbon monoxide, an odorless and deadly gas.
- Avoid engine muffler and nearby areas. Temperatures in these areas may exceed 150°F.

1. With the engine off, place the **Wheels/Tines/PTO Drive Lever** (Figure 4-2) in the **NEUTRAL** position. If in the **FORWARD** position, tap the lever sharply upward, it should automatically move into **NEUTRAL** position.

2. Put the **Depth Regulator Lever** in the **Travel** position (lever all the way down) so that the tines are off the ground. To do this, lift up on the handlebars, pull the lever (Figure 4-2) back, and push it down all the way to the top detent (notched) position.

3. Move the **Wheel Speed Lever** (Figure 4-2) to either the **SLOW** or **FAST** position. Be sure to roll the wheels while shifting the lever until the wheels engage.

NOTE: If using a PTO stationary attachment, move the **Wheel Speed Lever** into **FREEWHEEL** and block the wheels to prevent the equipment from moving (Figure 4-29 on page 29).

4. Move the **Tines/PTO Clutch Lever** into **DISENGAGE** position (Figure 4-2).

NOTE: Use the **ENGAGE** position if you want the tines to revolve or to apply power to a PTO-driven stationary attachment.

5. If engine is equipped with a fuel valve, turn valve to **OPEN** position as instructed in the separate **Engine Owner's Manual**.

6. If engine is equipped with an **ON/OFF** switch, move the switch to **ON**.

7. Move engine throttle lever (Figure 4-2) away from **STOP**.

8. Choke or prime engine as instructed in the separate **Engine Owner's Manual**.

9. If not equipped with an electric start system, place one hand on the fuel tank to stabilize the unit when you pull the recoil starter rope. Use the recoil starter rope to start the engine as instructed in the separate **Engine Owner's Manual**.

10. If equipped with an electric start system, turn key to **START** position to crank engine then release when engine starts. If the engine does not start right away, do not hold key at **START** for more than a few seconds. Release then try again after a short pause. Damage to starter motor can occur if it is cranked more than 15 seconds per minute.

11. If the engine does not start after a number of tries, refer to the **Engine Owner's Manual** for specific instructions.

12. When engine starts, move the **Throttle Lever** to the **SLOW** position and then gradually move choke lever (on engines so equipped) to **OFF** or **RUN** position.

13. Move the throttle speed control to **FAST** setting when tilling.

Starting Electric Start Engines with the Recoil Starter Rope

You may, at some point, have to start an electric start engine with the recoil starter rope. Before attempting to do so, perform the following applicable steps:

- If you suspect the battery charge is weak, and there is no visible damage. Disconnect cables from battery and clean both cable terminals, and the battery posts in accordance with the instructions provided in Section 5, *Battery Care and Maintenance*.

Section 4: Operation

Reconnect the cables and securely tighten to battery posts. The engine will recharge the battery if the battery is still good.

- If you suspect the battery is “dead”, or if the battery is damaged, disconnect, and remove it. Have it checked by a qualified technician.
- If battery has been removed, wrap cable terminals at end of positive cable with electrical tape and secure the cable to the battery bracket. This will prevent electrical discharge.
- Before pulling the recoil starter rope, turn the keyswitch to the RUN position. Move the Throttle Lever away from STOP position and set the choke as applicable. See Engine Owner’s Manual.

Cold Weather Operation

When temperatures fall below 40°F, do the following steps to protect your engine and transmission from damage:

1. Refer to the Engine Owner’s Manual for motor oil specifications for cold weather operation. Use winter blend gasoline.
2. Warm up the engine before putting it under a load.
3. Use winter-blend gasoline.
4. Use the correct weight gear oil in PTO Power Unit transmission.
5. Warm up the transmission gear oil as follows: With engine running, move Wheel Speed Lever (Figure 4-2) to FREEWHEEL (then block wheels so they can’t roll), put Tines/PTO Clutch Lever into DISENGAGE, then squeeze one of the Forward Interlock Levers and shift the Wheels/Tines/PTO Drive Lever to FORWARD.
6. If wheels are frozen to the ground, melt ice with warm water.

Stopping the Engine and Tiller

1. To stop the wheels and tines, move the Wheels/Tines/PTO Drive Lever into NEUTRAL position and then release both Forward Interlock Levers.

2. Move the engine Throttle Lever to the STOP position. Then on electric start models, turn the key to OFF. Remove the key for safekeeping.

NOTE: The engine may have a separate Throttle Control Lever and ON/OFF switch on the engine. These controls can also be used to stop the engine. See the Engine Owner’s manual for information specific to your engine.

Operating the Tiller

When first practicing, keep the Tines/PTO Clutch Lever in DISENGAGE position and the Wheel Speed Lever in SLOW position.

CAUTION

To avoid serious personal injury or damage to equipment:

- Always place Wheels/Tines/PTO Drive Lever in NEUTRAL before starting engine, and before engaging wheels, tines or other PTO attachments.
- Be sure there are no obstacles behind you before moving in reverse.
- Wheels/Tines/PTO Drive Lever should automatically return to NEUTRAL when released from REVERSE position. If it does not, move lever to NEUTRAL manually and discontinue use until you adjust the lever. See Section 5, *Checking and Adjusting Reverse Drive System*.
- No reverse motion should occur if Wheels/Tines/PTO Drive Lever is not held up in REVERSE. See Section 5, *Checking and Adjusting Reverse Drive System* for adjustment steps. Do not use tiller unless properly adjusted.
- Always return to NEUTRAL and let all motion stop before shifting to FORWARD or REVERSE.

The following pages provide guidelines for using your tiller effectively and safely in various gardening applications. Be sure to read *Tilling Tips & Techniques*, in this Section, before you actually put the tines into the soil.

This is a traditional standard-rotating-tine (SRT) tiller with forward rotating tines. It operates in a completely different manner than counter-rotating-tine (CRT) tillers, or from front-tine tillers.

Moving the Tiller Forward and Tilling

1. Start the engine and gradually increase engine speed to FAST (see *Starting the Engine*, this Section).

DANGER

The Forward Interlock Safety System is designed for the operator’s safety. Do not disconnect or attempt to defeat the purpose of the system. If the system malfunctions, immediately contact your local authorized dealer or the TROY-BILT Technical Service Department for assistance. Do not use the tiller or the PTO power unit until the Forward Interlock Safety System is functioning properly. Always test the system before using the tiller or PTO power unit.

2. Test the Forward Interlock Safety System. See *Testing Forward Interlock System*, this Section.

WARNING

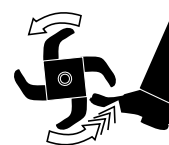

Keep away from rotating tines. Rotating tines will cause injury.

3. When practicing, set the Depth Regulator Lever to Travel position. Otherwise, set the Depth Regulator Lever to a desired depth.

4. Move Tines/PTO Clutch Lever to ENGAGE position if you want the tines to turn. If practicing, leave in DISENGAGE.

IMPORTANT: Do not move Tines/PTO Clutch Lever to ENGAGE unless Wheels/Tines/PTO Drive Lever is in NEUTRAL. Tiller damage may occur!

5. To move the tiller forward and engage the tines, squeeze and hold either Forward Interlock Lever (Figure 4-3) against the handlebar grip, then move the Wheels/Tines/PTO Drive Lever down to FORWARD position.

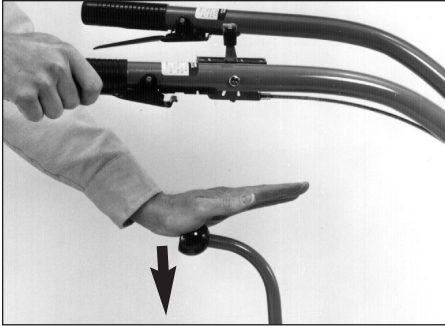

Figure 4-3: Moving tiller forward: squeeze one Forward Interlock Lever and then move Wheels/Tines/PTO Drive Lever down to FORWARD.

6. When the tiller moves forward, relax and let the wheels power the tiller along while the tines dig. Walk behind and to one side of the tiller. Walk on the side that is not yet tilled (Figure 4-4). Use a firm grip on the handlebars but keep your arm relaxed.

IMPORTANT: Let the tiller move ahead at its own pace. Do not push it ahead—this reduces operator control and tilling efficiency. Do not push handlebars down in an attempt to dig deeper—this takes weight off the wheels, reduces traction, and causes the tines to try to propel the tiller.

Stopping Forward Motion and Tines

1. To stop forward motion, tap Wheels/Tines/PTO Drive Lever upward into NEUTRAL. Then release the Forward Interlock Levers. The wheels and tines will stop and the engine will continue running.

2. In an emergency, release all of the control levers. This stops forward motion and shuts-off the engine.

CAUTION

To Help Avoid Personal Injury or Damage to Equipment:

- Be sure no obstacles are behind you before operating the tiller in REVERSE.
- Disengage the tines, reduce engine speed, and move the Wheel Speed Lever to SLOW position before operating in REVERSE. Avoid using FAST wheel speed until you are familiar with backing the tiller.



Figure 4-4: Guide tiller with one hand.

Moving the Tiller in Reverse

IMPORTANT: Do not till while in REVERSE.

1. Shift the Tines/Wheels/PTO Drive Lever (Figure 4-2) into NEUTRAL and move the Wheel Speed Lever to the SLOW position.
2. Move Tines/PTO Clutch Lever (Figure 4-2) into DISENGAGE position.
3. Verify that the area behind you is clear.
4. Lift up the handlebars until the tines are off the ground, then shift the Wheels/Tines/PTO Drive Lever all the way up and hold. You do not need to squeeze the Forward Interlock Levers to use reverse.
5. The unit immediately engages in reverse. Periodically check behind you while holding the handlebars up and the Wheels/Tines/PTO Lever in its upper-most position.

Stopping Reverse Motion

Release the Wheels/Tines/PTO Drive Lever—the lever automatically returns to the NEUTRAL position. This stops the wheels immediately. (The Forward Interlock Levers will not stop REVERSE motion.)

To Stop the Engine

Move the engine Throttle Lever to the STOP position. Then, on electric start models, turn key to OFF. Remove the key for safekeeping.

Making Turns

Turning the tiller is easy and just requires practice. First find the balance point between the engine and the tines by lifting up the handlebars (Figure 4-5). Once you find the balance point, then let the powered wheels do the turning as you push sideways on the handlebars in the direction of the turn. Practice the turning maneuver described here in a large open area. Once comfortable turning the tiller, you can then take it to the garden area.

1. At the end of a row, move the Wheels/Tines/PTO Drive Lever (Figure 4-2) to NEUTRAL position and reduce the engine speed.

2. Move the Tines/PTO Clutch Lever (Figure 4-2) into the DISENGAGE position.

3. Resume forward operation, and lift handlebars until tines are off the ground (Figure 4-5). Find the balance point between the engine and the tines. Then push the handlebars in the direction of the turn. *Be very careful to keep feet and legs away from the tines (which should be disengaged).* Let the powered wheels do the hard work. The inside wheel will pivot in place while the outside wheel drives the tiller around in the direction of the turn.

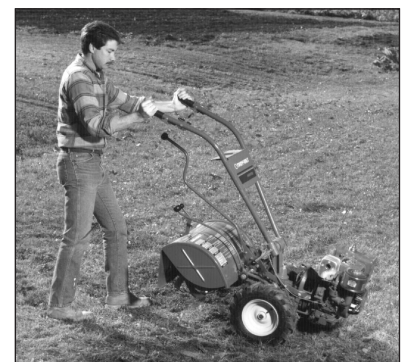

Figure 4-5: Turning the tiller.

NOTE: Use REVERSE if necessary to turn in a limited space.

Section 4: Operation

4. When the turn is complete, shift to NEUTRAL and lower the handlebars. Move Tines/PTO Clutch Lever back to ENGAGE position and resume forward operation.

Transporting The Tiller Around Your Property

When the engine is running, the tiller's powered wheels make moving the tiller to and from the garden easy. If the engine is not running set the Wheel Speed Lever to FREEWHEEL position to roll the tiller to another location.

⚠ WARNING

To help avoid personal injury from revolving tines, always put the Tines/PTO Clutch Lever in DISENGAGE position before transporting, loading, or unloading tiller.

1. Place the Tines/PTO Clutch Lever in DISENGAGE position.
2. Move Depth Regulator Lever down all the way into the Travel setting.
3. If using *engine power*, move Wheel Speed Lever to either SLOW or FAST, and use the Wheels/Tines/PTO Drive Lever to drive the wheels.
4. If the engine is stopped, move Wheel Speed Lever to FREEWHEEL, and manually push tiller.

Testing the Forward Interlock Safety System

The Forward Interlock Safety System is designed to shut the tiller engine off immediately if you lose control and cannot stop moving FORWARD by shifting the Wheels/Tines/PTO Drive Lever into NEUTRAL. When you release both Forward Interlock Levers, they send ground to the ignition system thereby stopping the engine. Squeezing one or both levers up against the handlebars enables the ignition system; therefore, you must squeeze at least one lever whenever the Wheels/Tines/PTO Drive Lever is engaged in FORWARD.

IMPORTANT: The interlock system also prevents the engine from starting if the Wheels/Tines/PTO Drive Lever is engaged in FORWARD.

⚠ DANGER

The Forward Interlock Safety System is designed for the operator's safety. Do not disconnect or attempt to defeat the purpose of the system. If the system malfunctions, immediately contact your local authorized dealer or the TROY-BILT Technical Service Department for assistance. Do not use the tiller or the PTO power unit until the Forward Interlock Safety System is functioning properly. Always test the system before using the tiller or PTO power unit.

How to Check the Interlock System

The Forward Interlock System has an electro-mechanical design, and so is subject to normal wear and possible malfunction. Check the system for proper operation each time prior to using the tiller or PTO power unit.



Figure 4-6: Plug and receptacle of Forward Interlock Safety System must be securely connected.

To test the Forward Interlock System:

1. Move tiller outside to level ground. Remove any obstacles.
2. Check that the Forward Interlock wire harness plug, at the bottom of the handlebars (Figure 4-6), is securely connected to the receptacle on the top, right side of the transmission.
3. Move Wheel Speed Lever (Figure 4-2) to SLOW position and move Tines/PTO Clutch Lever to DISENGAGE.

4. Start engine as described under *Starting and Stopping the Engine*, in this section. Set engine throttle lever to SLOW, and let engine warm up.

5. Squeeze and hold just one of the Forward Interlock Levers against the handlebar grip while moving the Wheels/ Tines/ PTO Drive Lever down to FORWARD (Figure 4-3). As the tiller moves forward, release the Forward Interlock Lever briefly. The engine should start to stall out if the interlock system is working properly. If it does start to stall, quickly squeeze the lever up against the handlebar grip, and then return the Wheels/ Tines/ PTO Drive Lever to NEUTRAL. Repeat this test to check that the engine begins to stall out when the other Forward Interlock Lever is released.

6. If the engine does not begin to shut off when either Forward Interlock lever is released, shut the engine off, remove the key (if electric start), and **do not operate the tiller or PTO power unit until the system has been repaired and is functioning properly.**

IMPORTANT: To avoid possible damage to the Forward Interlock Safety system, do not use high-pressure sprays near the wire harness receptacle or neutral plunger assembly.

Loading and Unloading the Tiller

The following provides information on tiller loading, unloading, and requirements before loading and unloading the tiller. Read the following instructions carefully before attempting to load or unload your tiller.

Before Loading or Unloading the Tiller

- Ramps must be strong enough to support the combined weight of the tiller and handlers. They should provide good traction to prevent slipping; they should have side rails to guide the tiller along the ramps; and they should have a locking device to secure them to the vehicle.
- Handlers should wear sturdy footwear that will help to prevent slipping.

Section 4: Operation

- Turn the vehicle's engine off and apply its parking brake.
- Position the loading vehicle so that the ramp angle is as flat as possible (the less incline to the ramp, the better).

Loading the Tiller

1. Use loading ramps that are strong and wide enough to safely hold the weight of the tiller and the operator combined—your tiller weighs between 280 and 325 lbs.
2. Move the Tines/PTO Clutch Lever (Figure 4-2) into DISENGAGE position.
3. Set the Depth Regulator lever (Figure 4-2) to the Travel position.
4. Move Wheel Speed Lever (Figure 4-2) into SLOW position and reduce the engine throttle speed.
5. Shift the Wheels/Tines/PTO Lever (Figure 4-2) into FORWARD position and follow the tiller up the ramps (Figure 4-7). Check the wheels as you move the tiller forward. Ensure that they move up the center of each ramp.
6. Prevent tiller from rolling in vehicle. Leave Wheel Speed Lever in FAST or SLOW position, chock wheels with blocks and tie down the tiller.

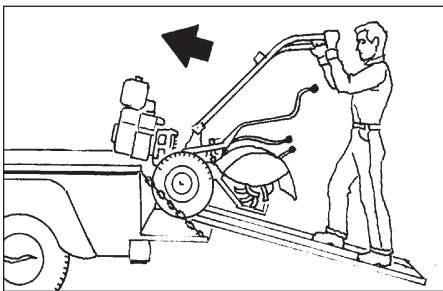

Figure 4-7: To go up ramps, use

Unloading the Tiller

IMPORTANT: *Never* unload the tiller in FORWARD drive. The tiller could tip forward and expose you to the tines (which should be disengaged as instructed).

1. Use loading ramps that are strong and wide enough to safely hold the weight of the tiller and the operator combined—your tiller weighs between 280 and 325 lbs.

2. Move the Tines/PTO Clutch Lever (Figure 4-2) to DISENGAGE position.
3. Set the Depth Regulator Lever (Figure 4-2) to the Travel position.
4. Move Wheel Speed Lever (Figure 4-2) to SLOW position and reduce the engine throttle speed.

IMPORTANT: Look behind you before you back down the ramp to ensure that all is clear. While descending, keep checking for obstacles behind you.

5. Move and hold the Wheels/Tines/PTO Lever into REVERSE drive and back down the ramps (Figure 4-8). Check the wheels as you move the tiller backward. Ensure that they move down the center of each ramp.

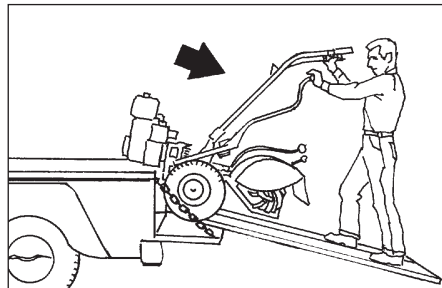

Figure 4-8: To go down ramps, use REVERSE drive.

Changing Speed Belts

Your tiller has two belt-driven speed ranges – HIGH RANGE and LOW RANGE – you pick one or the other by deciding which set of pulley grooves to move the forward belt into. By moving the belt from one speed range into the other, in combination with the FAST and SLOW wheel speeds, you obtain a choice of four different forward wheel speeds and two different tine speeds.

⚠ WARNING

To help avoid serious personal injury, stop the engine, remove the ignition key, disconnect spark plug wire and move the wire away from the spark plug, and let engine and muffler cool down before changing belt speeds.

Changing the belt from LOW range into HIGH range (or back again) is a matter of moving the belt from one set of pulley grooves to a second set of pulley grooves.

This change is done quickly and without tools (Figures 4-9 through 4-13).

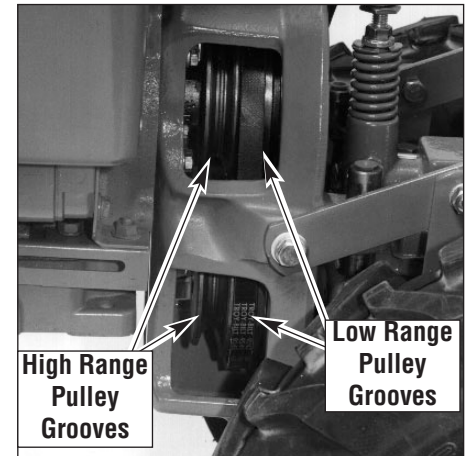

Figure 4-9: Belt range positions.

When the tiller is moving in REVERSE, the wheels are powered by a rubber reverse disc, not by the belt. Therefore, you have only two reverse speeds SLOW and FAST, as set with the Wheel Speed Lever.

Table 4-1 shows the range of wheel and tine speeds available when using the two belt speed ranges and the FAST and SLOW selections on the Wheel Speed Lever.

Table 4-1

Available wheel and tine speeds at 3000 RPM engine speed.			
Belt Position	Wheel Speed Lever	Wheel Speed	Tine Speed
Low Range	Slow	.5MPH	146RPM
Low Range	Fast	1.2MPH	146RPM
High Range	Slow	.7MPH	200RPM
High Range	Fast	1.72MPH	200RPM

Changing Belt From LOW Range to HIGH Range

1. To avoid personal injury, shut off engine, let all moving parts come to a complete stop, then disconnect spark plug wire from spark plug and move it away from spark plug before making any adjustments. Wait for the engine and muffler to cool down.
2. Move Wheels/Tines/PTO Drive Lever into NEUTRAL.

Section 4: Operation

WARNING

The **HIGH** speed belt range position combined with a **FAST** wheel speed setting propels the tiller at the fastest pace. Reduce the engine throttle speed when starting out to help avoid personal injury or property damage if using this speed combination.

3. Kneel on *left side* of tiller. To create belt slack, reach over to *right side* of the pulleys and push in at the center of the belt with a finger. At the same time, use your left hand to work the belt part-way onto the lower-front transmission pulley groove (Figure 4-10).



Figure 4-10: Low range to high range. Shows moving belt from lower-rear groove onto lower-front groove.

4. Go to the other side of the tiller to finish seating the belt onto the pulley groove.
5. Working from the *left side* of the tiller, work the belt as much as possible onto the top-front engine pulley groove (Figure 4-11).
6. Finish seating the belt from the *right side* of the tiller.

IMPORTANT: Proper belt tension is important for good performance. See Section 5, *Drive Belt Maintenance* for information on belt maintenance schedule and procedures.

NOTE: If extra belt slack is needed to move the belt, just raise the Wheels/Tines/PTO Drive Lever up into REVERSE. This lowers the engine pulley, and creates more slack.



Figure 4-11: Low range to high range. Shows moving belt from top-rear groove onto top-front groove.

7. Check *both sides* of the high range pulley grooves to verify that the belt is properly seated.

Changing Belt From HIGH Range to LOW Range

1. To avoid personal injury, shut off engine, let all moving parts come to a complete stop, then disconnect spark plug wire from spark plug and move wire away from spark plug before making any adjustments. Let engine and muffler cool.
2. Move the Wheels/Tines/PTO Drive Lever into NEUTRAL.
3. Stand on *left side* of tiller. Use your right hand to hold the Wheels/Tines/PTO Drive Lever up into REVERSE position. Use your left hand to move the belt off top-front engine pulley groove to top-rear engine pulley groove (Figure 4-12).



Figure 4-12: High range to low range. Shows moving belt from top-front groove onto top-rear pulley groove.

4. Go to right side of tiller and finish seating the belt.
5. Still holding the lever up in REVERSE position, and working from the left side of the tiller, move the belt from the lower-front transmission groove to the lower-rear transmission groove.
6. Go to the right side of the tiller and finish seating the belt (Figure 4-13).



Figure 4-13: High range to low range. Shows moving belt from lower-front onto lower-rear groove.

7. Check that the belt is fully seated in the pulley grooves. Check this from both sides of the tiller.

Choosing Wheel and Tine Speeds

Your tiller has four FORWARD wheel/tine speed combinations for handling a variety of tilling tasks and gardening jobs. Experiment with the tine depth, engine speed, and wheel/tine speed and determine the combination that provides the best results. Here are some tips:

1. Advance the throttle lever so the engine has sufficient power.
2. When tilling untilled or hard earth, do not set the Depth Regulator too deep. The tiller will buck and the engine will load down.
3. You will know your settings are ideal when the tines break-up the soil easily, the engine does not labor, and your progress is steady and smooth.

See Table 2, *Wheel Speed and Belt Range Selection Guide* for recommendations.

TABLE 2-4: WHEEL SPEED AND BELT RANGE SELECTION GUIDE

IMPORTANT — For correct wheel speed and belt range choices when using attachments or accessories other than tines, read the Owner/Operator Manual provided with the attachment or accessory.

SLOW GEAR, LOW BELT RANGE	SLOW GEAR, HIGH BELT RANGE	FAST GEAR, LOW BELT RANGE	FAST GEAR, HIGH BELT RANGE
<p>For:</p> <ul style="list-style-type: none"> • Tilling in sod. • Tilling in hard clay. • Tilling under standing corn-stalks in tough soil conditions. • Tilling under cover crops. • Preparing a deep seedbed. • Tilling in stony soil. • Tilling under residues and organic matter. • Mixing in fertilizers, manure. 	<p>For:</p> <ul style="list-style-type: none"> • Tilling in sod or hard clay. • Tilling under standing corn-stalks (slow, steady speed allows time to shred stalks). • Tilling under cover crops (best wheel speed and belt speed range in most soils). • Preparing seedbeds (best speed choice in most soils). • Tilling in stony ground. • Building raised garden beds. • Mixing in fertilizer. • Using hiller wings in hard soil. • Mixing fertilizer and manure. • Tilling residues and organics. 	<p>For:</p> <ul style="list-style-type: none"> • Going over seedbed for the last time before planting crops. • Covering over seeds in wide row or plot planting (lift handlebars to avoid going too deep). • Hilling and furrowing. • Making raised beds. • Cultivating (lift handlebars to avoid going too deep). • Tilling large areas. • Tilling organic matter in. • Cultivating between raised beds with optional hiller/furrower attachment. 	<p>For:</p> <ul style="list-style-type: none"> • Preparing seedbeds for planting. • Covering seeds with less need to hold up the handlebars. • Cultivating (tiller travels faster, rides higher on the soil; allows engine RPM to be reduced; handlebars don't have to be raised). • Keeping large areas tilled and cultivated in the summer. • Tilling organic matter under. • Moving tiller quickly. • Cultivating between raised beds using the optional hiller/furrower.

Tilling Tips & Techniques

Let the tiller do the work

- While tilling, relax and let the wheels pull the tiller along while the tines do the digging. Walk on the side that is not yet finished (to avoid making footprints in the freshly tilled soil) and lightly, but securely grip the handlebar with just one hand (Figure 4-4).
- Avoid pushing down on the handlebars in an attempt to force the tiller to dig deeper. Doing so takes the weight off the powered wheels, causing them to lose traction. Without the wheels helping to hold the tiller back, the tines will attempt to propel the tiller – often causing the tiller to skip rapidly across the ground. (Sometimes, slight downward pressure on the handlebars will help get through a particularly tough section of sod or unbroken ground, but in most cases this won't be necessary.)

Tilling depths

- *Avoid trying to dig too deeply too quickly, especially when busting sod or tilling soil that hasn't been tilled for some time.* Use shallow depth settings (only an inch or two deep) for the first passes through the garden area.

With each succeeding pass, adjust the depth regulator to dig another inch or two deeper. (Watering the garden area a few days prior to tilling will make tilling easier, as will letting the newly worked soil set for a day or two before making a final, deep tilling pass.)

- When cultivating (breaking up the surface soil around plants to help destroy weeds), use very shallow depth settings to prevent injury to plants whose roots often grow close to the surface. If needed, lift up on the handlebars slightly to prevent the tines from digging too deeply. Cultivating on a regular basis not only eliminates weeds, it also loosens and aerates the soil for better moisture absorption and faster plant growth.

Avoid tilling wet, soggy soil

Tilling wet soil often results in large, hard clumps of soil that can interfere with planting. If time permits, wait a day or two after heavy rains to allow the soil to dry before tilling. Test the soil by squeezing it into a ball. If it compresses too easily, it is too wet to till.

WARNING

To help avoid personal injury, be aware that the tiller can unexpectedly bounce up or jump ahead and propel away from you if the tines strike hard or frozen ground, or buried obstacles like large stones, roots or stumps. Always use the following precautions to help maintain control of the tiller:

- **Walk behind and to the side of the tiller. Use one hand on the handlebars, relaxing your arm but with a secure hand grip.**
- **Use shallow depth regulator settings. Till gradually deeper.**
- **Use slower wheel, tine and engine speeds.**
- **Clear the tilling area of all large stones, roots and other debris.**
- **Do not put downward pressure on the handlebars. If needed, apply slight upward handlebar pressure to keep the tines from digging too deeply.**
- **Avoid contacting hard soil or sod at the end of a row – reduce engine speed and lift handlebars to raise tines out of the soil.**
- **In An Emergency, stop tines and wheels by moving Wheels/Tines/ PTO Drive Lever to NEUTRAL. If you cannot reach the lever or have lost control, Let Go Of The Handlebars and All Controls.**

Tilling Tips & Techniques

Avoid making footprints

When possible, walk on the untilled side of the unit to avoid making footprints in the freshly tilled soil (Figure 4-4). Footprints cause soil compaction that can hamper root penetration and contribute to soil erosion. They can also “plant” unwanted weed seeds back into the newly tilled soil.

Suggested tilling patterns

- When preparing a seedbed, go over the same path twice in the first row, then overlap one-half the tiller width on the rest of the passes (Figure 4-14). When finished in one direction, make a second pass at a right angle as shown in Figure 4-15. Overlap each pass for best results (in very hard ground it may take three or four passes to thoroughly pulverize the soil).
- If the garden size will not permit lengthwise and then crosswise tilling, then overlap the first passes by one-half a tiller width, followed by successive passes at one-quarter width (Figure 4-16).
- With planning, you can allow enough room between rows to cultivate (Figure 4-17). Leave room for the hood width, plus enough extra room for future plant growth.

Tilling on slopes

If you must garden on sloping ground, please follow two very important guidelines:

1. Till only on moderate slopes, never on steep inclines where footing is difficult (review safety rules in the “Safety” Section of this Manual).
2. We recommend tilling up and down slopes rather than terracing. Tilling vertically on a slope allows maximum planting area and also leaves room for cultivating.

IMPORTANT: When tilling on slopes, be sure the correct oil level is maintained in the engine (check every one-half hour of operation). The incline of the slope will cause the oil to slant away from its normal level and this can starve engine parts of required lubrication. Keep the engine oil level at the full point at all times!

A. Tilling up and down slopes:

- To keep soil erosion to a minimum, be sure to add enough organic matter to the soil so that it has good moisture-holding texture and try to avoid leaving footprints or wheel marks.

⚠ WARNING

To avoid serious personal injury or damage to the equipment:

- Do not operate tiller on a slope too steep for safe operation. Go slowly on any slope. Make sure you have good footing.
- Wear footwear that increases stability and reduces slippage.
- Do not use FAST wheel speed position when on sloped ground.
- Do not shift the Wheel Speed Lever when heading up or down a slope. If lever is accidentally moved to FREE WHEEL position, the tiller could roll out of control.
- To prevent engine damage due to oil starvation (on slopes, the engine is inclined and oil moves away from surfaces that need lubrication), be sure the correct oil level is maintained during all uphill/downhill tilling operations. Check the level of the oil in your engine after every one-half hour of operation.

- When tilling vertically, try to make the first pass uphill as the tiller digs more deeply going uphill than it does downhill. In soft soil or weeds, you may have to lift the handlebars slightly while going uphill. When going downhill, overlap the first pass by about one-half the width of the tiller.

HINT: For best results, use the HIGH belt range and SLOW wheel speed lever position. See *Changing Speed Belts* in this section for more information on changing to high range.



Figure 4-14

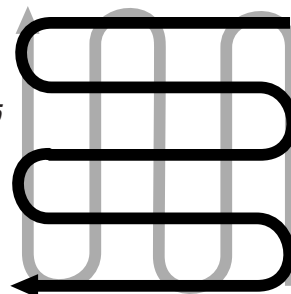

Figure 4-15



Figure 4-16



Figure 4-17

Tilling Tips & Techniques

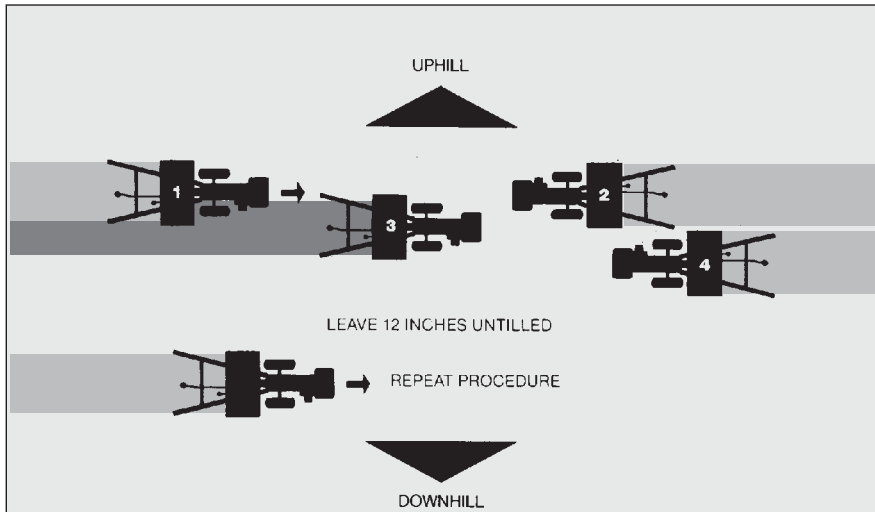

Figure 4-18

B. Terrace Gardening:

- When a slope is too steep or too short for vertical tilling, it may be necessary to till across the slope and create terraced rows. Terraces are rows that are cut into the side of a slope, creating a narrow, but flat area on which to plant.
- On a long slope, you can make several terraces, one below the other.
- Terraces should be only 2-to-3 feet wide. Digging too far into the side of the slope will expose poor subsoil that is unproductive for plants.
- To create a terrace, start at the top of the slope and work down. Go back and forth across the first row as shown in Figure 4-18.
- Each succeeding lower terrace is started by walking below the terrace you're preparing. For added stability of the tiller, always keep the uphill wheel in the soft, newly tilled soil. Do not till the last 12" or more of the downhill outside edge of each terrace. This untilled strip helps prevent the terraces from breaking apart and washing downhill. It also provides a walking path between rows.

C. Tilling across slopes without terracing

- If vertical or terracing gardening aren't practical for you, then you can till laterally across a slope. We don't really recommend this method as it can create unsure footing and invites soil erosion.
- Study the terrain to make certain the slope is not too steep for safe tilling. If possible, make terraced rows or till vertically.
- Move the belt into LOW belt range and the Wheel Speed Gear Lever to SLOW position. As in terrace gardening, start at the top of the slope and overlap the first pass by half the width of the tiller. For added stability, keep the uphill wheel in the soft, newly tilled soil. Each succeeding terraced area is started by walking *below* the terrace you are preparing (Figure 4-19).

Clearing the tines

The tines have a self-clearing action which helps to eliminate most tangling of debris. However, occasionally dry grass, stringy stalks or tough vines may become tangled.

Follow these procedures to help avoid tangling and to clear the tines, if necessary.

⚠ WARNING

Before clearing the tines by hand, stop the engine, allow all moving parts to stop and disconnect the spark plug wire. Failure to follow this warning could result in personal injury.

- To reduce tangling, set the Depth Regulator deep enough to get maximum "chopping" action as the tines chop the material against the ground. Also, try to till under crop residues or cover crops while they are green, moist and tender.
- While power composting, try swaying the handlebars from side to side (about 6" to 12"). This "fishtailing" action often clears the tines of debris.
- It may be necessary to remove the debris by hand (a pocket knife will help you to cut away the material).

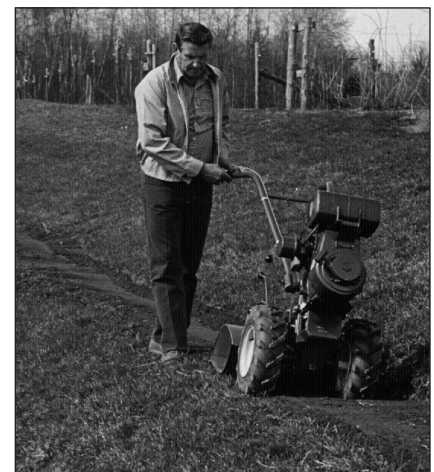

Figure 4-19: Make a terrace in just 4 or 5 passes with the tiller.

Tilling Tips & Techniques

POWER COMPOSTING

Power composting means tilling under and burying in the soil all manner of organic matter such as crop residues, leaves, grass clippings and cover crops. This material will decompose during the non-growing season and add important natural nutrients to the soil.

WARNING

When power composting, do not keep the Depth Regulator Lever at a deep setting if the tiller jumps or bucks.

If jumping or bucking occurs, move the Depth Regulator Lever down to one of the shallower settings and then slowly increase the tilling depth on later passes.

Failure to comply could result in loss of tiller control, property damage or personal injury.

Begin by composting crop residues such as leftover vines, stalks, stems and roots. Power compost these crop residues as soon as they finish bearing. The sooner this is done, the better, as tender green matter is easier to till under. Use the deepest depth regulator setting possible without causing the engine to labor or the tiller to jump ahead.

Standing cornstalks of reasonable height can be power composted (Figure 4-20). Pushing over (but not uprooting) cornstalks will often make it easier for your tiller to chop up the stalks. Keep the tines clear of excessive tangling by “fish-tailing” or frequently using reverse. Make several passes, then return a few days later to finish off any remaining stubble.

After tilling under crop residues, add more organic matter such as leaves, grass clippings and even kitchen scraps. When tilled into the soil, this organic matter will decompose and add even more important nutrients to the soil.

After power composting, you may want to plant a “green manure” cover crop to protect the soil during the off-season.

Grow a crop of clover, alfalfa, buckwheat, peas, beans, rye grass, grain, or kale and then till it into the soil prior to the planting season.

Wide-Row Planting

The wide-row planting technique is spreading seeds anywhere from 10 inches to 2 feet wide or more. As a result, you can grow anywhere from 3 to 4 times (or more) produce in the same space that is normally set aside for an area that has narrow, single rows.

Wide-row planting automatically shades the ground which keeps weed growth down and also holds moisture in the soil. And of course, harvesting is much easier – everything is right at hand to be picked. Preparing wide rows is easy — after you prepare the seedbed and mark off the rows with string, hand-broadcast the seeds as if seeding a lawn (not quite as much as lawn seed). Cover with soil and tamp the area firmly with a hoe.

Tilling Under Corn

After corn is harvested, the stalks should be tilled into the soil while still green. Dry plants are more difficult to till under, and the roots break loose too easily.

IMPORTANT: Do not pull the roots out by hand or cut the stalks before tilling. Stalks that are firmly anchored by their roots are much easier for the tines to chop, cut, and work under.

1. As you move forward into a row of stalks, aim the tiller so that the stalks go between the left wheel and the transmission case (Figure 4-19). Do not use the right wheel because damage could occur to the air cleaner, carburetor or throttle linkage.



Figure 4-20: Tilling under corn stalks.

2. Each new pass should overlap the previous pass by one-half the width of the tiller.

3. Till as deeply as possible. Pull the Depth Regulator all the way UP and engage the lowest notch for deep tilling. Use either LOW or HIGH belt range and SLOW wheel speed gear position.

Let the tilled-in stalks decompose for a week or so. Then till in the remaining residue as deep as possible.

Soil Enrichment Idea

Trench Composting — Trench composting is easy with the optional Hiller-Furrower Attachment (Section 5). Dig a trench, put in all kinds of organic matter, and cover with soil. Earthworms and microbes will break it down quickly.

PTO POWER UNIT

Your tiller is a self-contained PTO (Power Take-Off) Power Unit that was shipped with a tine attachment installed. The tine attachment can be quickly removed and replaced with other optional attachments. The following instructions will familiarize you with your PTO Power Unit. Please read these pages carefully.



Figure 4-21: PTO Power Unit and tine attachment.

Removing And Replacing The Tine Attachment

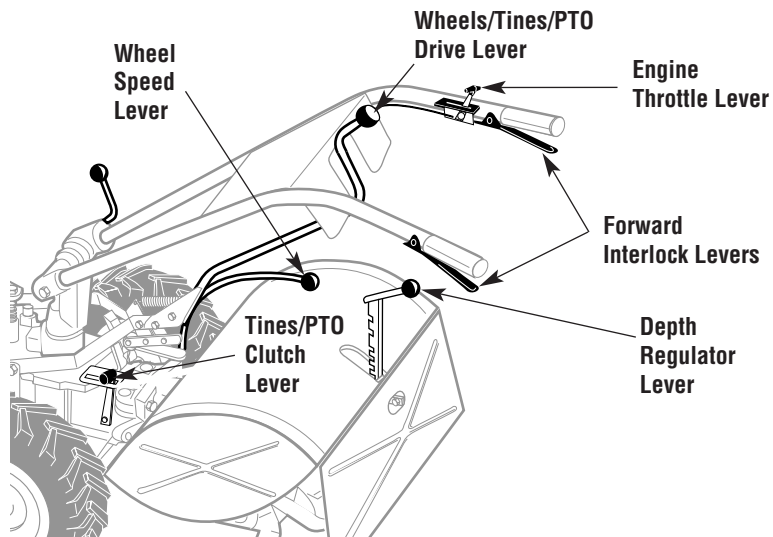

Figure 4-22: PTO Power Unit controls.

VERY IMPORTANT

Before operating your PTO Power Unit for the first time, make sure that you have:

- Read all the safety instructions in Section 1 of this Manual and in the Manual supplied with any attachment.
- Read the controls information and operating procedures for the tiller and engine described in Sections 3 and 4 of this Manual and in the Engine Owner's Manual.
- Read and understand the assembly instructions, controls information, and operating procedures for the attachment as described in the Attachment Owner's Manual supplied with the attachment.

The following steps explain how to remove and replace the tine attachment. You will need a 3/4" wrench (minimum 12" long for leverage).

Removing Tine Attachment

1. Move the tiller to level ground.
2. Be sure the engine is stopped, the electric start key is removed, and the spark plug wire is disconnected and moved away from spark plug.

CAUTION

TO AVOID PERSONAL INJURY OR DAMAGE TO EQUIPMENT:

- Stop the engine, remove the electric start key, disconnect the spark plug wire and let the engine and muffler cool before removing or installing any attachment.
- Do not place hands, tools, or any object near or inside the PTO access area while the engine is running.
- When removing or replacing the tine attachment, be careful of the sharp edges on the tiller hood. Wear thick gloves for hand protection.
- When the tine attachment is removed, always prop it up with a block to prevent the attachment from falling forward.

3. Place a sturdy support under the engine to prevent the engine from tipping forward when the tine attachment is removed (Figure 4-23).

4. Place the Wheels/Tines/PTO Drive Lever into NEUTRAL (Figure 4-22).

5. Place Tines/PTO Clutch Lever in DISENGAGE (Figure 4-22).

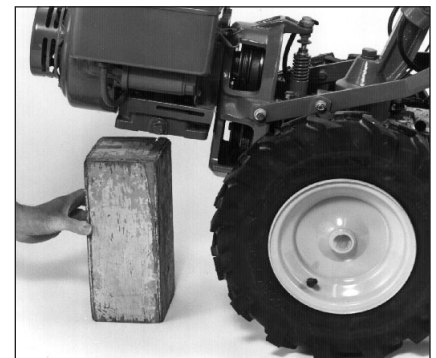

Figure 4-23: Block up engine.

6. Place Wheel Speed Lever into FREE WHEEL (Figure 4-22).

7. Loosen the two swing-out bolts (Figure 4-24) that connect the power unit transmission to the tine attachment and swing out the bolts (Figure 4-25).

HINT: Loosening swing-out bolts can be difficult. Use an extra-long wrench for leverage.

8. Tip the PTO power unit forward about one inch with one hand while pulling the tine attachment back (Figure 4-26). The guide pin on the power unit will slide out of the guide hole in the tine attachment (Figure 4-27).

Section 4: Operation



Figure 4-24: Loosening attachment swing-bolts.

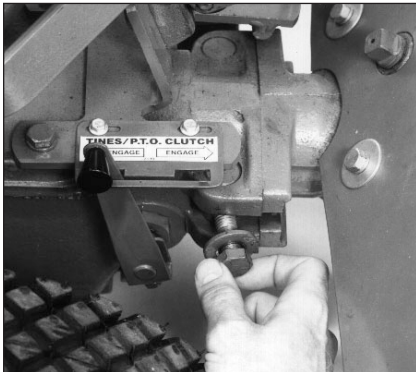

Figure 4-25: Moving swing-bolts outward.

IMPORTANT: Store tine attachment in a level, upright position to prevent gear oil from leaking from the dipstick area.

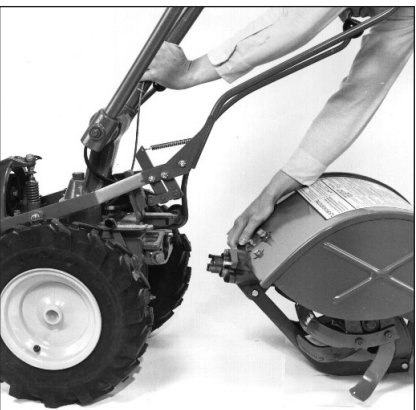

Figure 4-26: Pulling attachment away from power unit.

9. To keep the tine attachment dog clutch coupling clean, cover with the dust cap (on some attachments) or plastic wrap.

10. The PTO Power Unit is now ready to install other powered or non-powered attachments. See the attachment's Owner's Manual for installation and operation instructions specific to that attachment.

Installing the Tine Attachment

1. Move the two PTO Power Unit swing-out bolts outward and slide the washers up against the bolt heads.
2. Remove the support block from under the engine and slowly roll the power unit back next to the tine attachment. Place the support block back under the engine.
3. Remove the dust cap (or protective wrapping) from the dog clutch coupling on the tine attachment.
4. Carefully align the guide pin on the PTO Power Unit with the alignment hole in the tine attachment and bring the two units together (Figure 4-27).

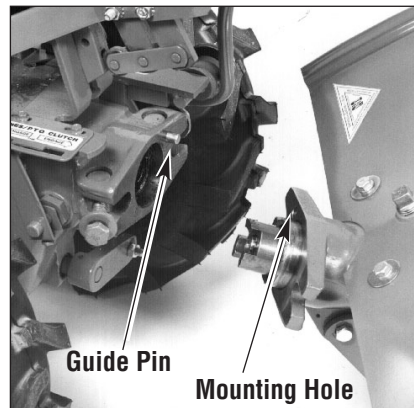

Figure 4-27: Aligning guide pin with mounting hole.

5. Move the two swing-bolts into the slots of the tine attachment. Alternately tighten each bolt until they are tight enough to make the concave washers flat. *The bolts must be very tight – if you have a torque wrench, tighten each bolt to between 70 and 80 ft.-lbs.*

IMPORTANT: The swing-bolts must be kept very tight to prevent damaging wear to the dog clutch coupling, alignment pin or the alignment hole. Check bolt tightness every 2-1/2 operating hours.

6. Remove the engine support before moving the tiller in a forward direction.

PTO POWER UNIT OPERATING INSTRUCTIONS

⚠ WARNING

To help avoid personal injury or damage to equipment, read the attachment's Owner's Manual supplied with each attachment before installing or operating an attachment. Please read all control, operation and safety instructions.

The following are operating instructions specifically for the PTO Power Unit. Read the separate Owner's Manual supplied with each attachment before attempting to assemble, attach, transport or operate the attachment. If needed, please contact us for a replacement manual. See the back cover for customer support information.

⚠ WARNING

To help avoid personal injury, always disengage the Tines/ PTO Clutch Lever before towing any attachment.

Some attachments have a drive shaft or a hydraulic pump that is powered by the engine on the PTO Power Unit. These units are called Stationary Attachments, since they remain in one location when operating. Attachments can be towed to a work site with the PTO Power Unit as described in *Operating Non-Powered Attachments*. Other attachments are pulled or towed behind the PTO Power Unit. These attachments are called Non-Powered Attachments.

Setting Up Stationary Attachments

⚠ WARNING

To help avoid personal injury, never allow people to ride on any PTO Power Unit or attachment.

1. Move the Tines/PTO Clutch Lever to DISENGAGE.
2. Move Wheel Speed Lever (Figure 4-22) to FREEWHEEL, then block all wheels (Figure 4-29) to prevent the equipment from rolling.

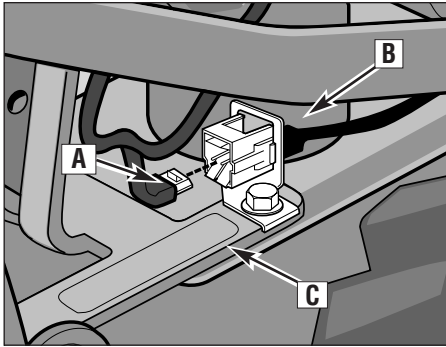

Figure 4-28: Forward Interlock Wiring
A - PTO Power Unit Interlock Harness
B - Forward Interlock Receptacle
C - Attachment Interlock Wire

3. On the PTO Power Unit, unplug the Forward Interlock Wire Harness that leads from the base of the handlebars (A, Figure 4-28) to the receptacle (B) located on the top, right side of the transmission cover.

4. On the Stationary Attachment, locate the interlock wire (C, Figure 4-28) and clean contacts on plug and receptacle (B). This connection enables you to operate the Wheels/Tines/PTO Drive Lever in FORWARD without having to squeeze a Forward Interlock Lever.

5. Connect the plug from the Stationary Attachment (C, Figure 4-28) to the receptacle on the PTO Power Unit (B). The connection must be tight.

Setting Up Non-Powered Attachments

1. Move the Tines/PTO Clutch Lever (Figure 4-22) to DISENGAGE.

2. Move the Wheel Speed Lever (Figure 4-22) to either SLOW or FAST position. To do this, roll the PTO Power Unit while shifting lever until wheels engage.

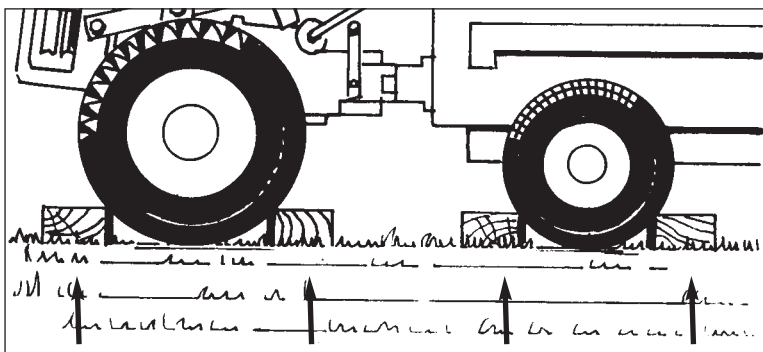

Figure 4-29: Block wheels on PTO Power Unit and stationary attachment.

3. Verify that the Forward Interlock Wire Harness plug at the base of the handlebars (A, Figure 4-28) is connected to the Forward Interlock Wire Harness receptacle (B) on the top right side of the transmission.

Starting The Engine

IMPORTANT: Refer to *Cold Weather Operation* instructions, in this section, before operating in temperatures below 40°F.

1. Move the Wheels/Tines/PTO Drive Lever into NEUTRAL. To find NEUTRAL (be sure engine is off), push lever down and engage it in FORWARD then tap the lever upward to automatically move into NEUTRAL.

2. Move the Tines/PTO Clutch Lever into DISENGAGE position.

⚠ WARNING

To avoid injury, do not run the engine in an enclosed or poorly vented area. Engine exhaust contains carbon monoxide, an odorless and deadly gas.

3. Start Engine. See *Starting and Stopping the Engine*, in the beginning of this section, for detailed starting information. Also see the Engine Owner's Manual.

4. For non-powered attachments only test the Forward Interlock Safety System. See *Testing the Forward Interlock Safety System*, in this section, for a procedure.

Operating Stationary Attachments

1. Move Tines/PTO Clutch Lever (Figure 4-22) into ENGAGE.

2. To apply power to PTO-driven attachments, move Wheels/Tines/PTO Lever (Figure 4-22) down to FORWARD position (*do not use REVERSE with stationary attachments*).

3. To stop the PTO Power Unit, tap the Wheels/Tines/PTO Drive Lever upward into NEUTRAL position.

Operating Non-Powered Attachments (or to Tow Stationary Attachments)

1. To move forward, squeeze and hold one Forward Interlock Lever (Figure 4-30) up against the handlebars, and move the Wheels/Tines/PTO Drive Lever down to FORWARD.

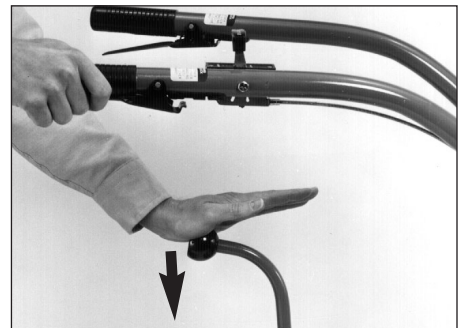

Figure 4-30: Moving tiller forward: squeeze one Forward Interlock Lever and then move Wheels/Tines/PTO Drive Lever down to FORWARD.

2. To stop forward motion, tap Wheels/Tines/PTO Drive Lever upward into NEUTRAL, then release the Forward Interlock Levers.

3. To stop forward motion in an emergency, release all PTO Power Unit controls (stops engine).

4. To move in reverse, reduce the engine speed then shift the Wheel Speed Lever into SLOW. Move and hold the Wheels/Tines/PTO Drive Lever all the way up. Ensure that the area behind you is clear of all obstacles, before moving the lever into REVERSE.

5. To stop moving in REVERSE, release the Wheels/Tines/PTO Drive Lever.

Stopping the Engine

Move the Engine Throttle Lever to STOP. Turn keyswitch to OFF on electric start models.

Section 5 Maintenance

⚠ WARNING

Before inspecting, cleaning or servicing the machine, shut off engine, wait for all moving parts to come to a complete stop, disconnect spark plug wire and move wire away from spark plug. Remove ignition key on electric start models.

Failure to follow these instructions can result in serious personal injury or property damage.

NOTE: All references to left, right, front and rear of the machine are determined by standing behind the handlebars and facing the direction of forward travel.

REQUIRED MAINTENANCE SCHEDULE

PROCEDURE	Before Each Use	Every 10 Hours	Every 25 Hours	Every 30 Hours	As Noted
Check engine oil level	•				Every 5 operating hrs.
Clean engine cooling system	•				
Test operation of Forward Interlock Safety System	•				Section 4
Forward Interlock Safety System – check wire condition, connections		•			
Check electrical connections		•			
Recharge battery					Before/after long storage
Check drive belt tension		•			After initial 2 hours
Check nuts and bolts		•			After initial 2 hours
Clean tiller tine shaft		•			
Lubricate tiller		•			
Change engine oil*		•			More often in dusty or dirty areas
Clean foam element air filter Check paper element air filter			• •		More often in dusty or dirty areas
Check for oil leaks			•		After initial 2 hours
Check gear oil level in both transmissions				•	After initial 2 hours
Check bolo tines for wear				•	
Check reverse disc for wear				•	
Check air pressure in tires				•	
* During engine break-in period, change engine oil after first 2 hours of operation.					

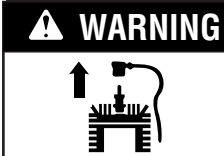

WARNING Before inspecting, cleaning or servicing the machine, shut off engine, wait for all moving parts to come to a complete stop, disconnect spark plug wire and move wire away from spark plug. Remove ignition key, if so equipped.

Failure to follow these instructions can result in serious personal injury or property damage.

Tighten Bolts and Nuts

Check for loose or missing hardware every ten (10) operating hours. Failure to tighten or replace fasteners can cause poor performance, equipment damage or oil leakage. See your Parts Catalog for complete fastener descriptions.

Most hardware on your tiller is visible. Pay particular attention to hardware shown in Figures 5-1, 5-2, 5-3 and 5-3A.

1. Check the transmission pulley mounting bolt (Figure 5-1). If the washer behind the bolt head is loose, the bolt needs tightening. To do this, first insert a punch or thick screwdriver into the hole next to the bolt and wedge the tool against the side of the motor mount casting. This immobilizes the pulley while you tighten the bolt.
2. Check jam nut on left side of neutral plunger assembly (Figure 5-2). If loose, immobilize bolt head with one wrench and use another wrench to tighten the nut.
3. Check the three rear bearing cap screws under the depth regulator mounting bracket (A, Figure 5-3). If any is loose, it can cause an oil leak or drive shaft end play.

4. Check the five bolts securing the tiller housing cover to the left side of the transmission (B in Figure 5-3). Gear oil can leak from a loose housing cover. To reach the bolts, remove the left side tine holder. See *Bolo Tine Maintenance* in this Section for tine holder removal directions.

5. Check both swing-bolts (C, Figure 5-3) that connect the power unit transmission to the tine attachment. Both bolts should be checked every 2-1/2 hours of operation. If loose, wear can occur on the locating pin on the power unit, and cause enlargement of the locating hole in the tine attachment. Using a torque wrench, tighten these bolts to 70-to-80 ft.-lbs.

6. Check the locknut that fastens the shifting linkage to the eccentric shifting lever (D, Figure 5-3). Do not tighten the locknut against the eccentric lever. It should be very close to, but not touching the lever.

7. Check the four bolts and nuts securing left and right tine holders to the tine shaft (Figure 5-3A).

IMPORTANT: Give screws or bolts that go into the transmission housing a coating of non-hardening gasket sealant to prevent gear oil from leaking.

Tiller Lubrication

Proper lubrication of the tiller's mechanical parts is an essential part of good maintenance. Lubrication should be done after every ten (10) hours of operation.

Use ordinary motor oil (#30 weight or lighter) where oil is specified. Use a quality grease with a metal lubricant where grease is recommended (regular grease is acceptable). Do not over lubricate. If there is a build-up of dirt, remove the build-up and re-apply oil or grease.

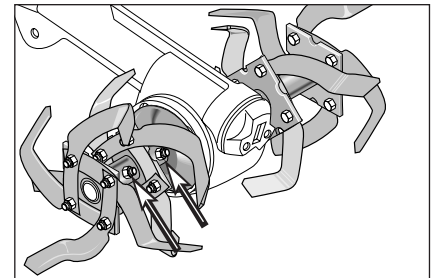

Figure 5-3A: Tine holder hardware must be tight.

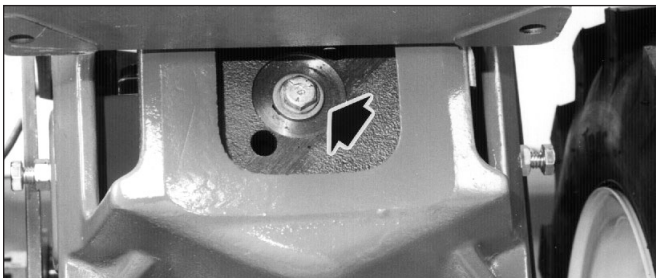

Figure 5-1: Check bolt on transmission pulley.

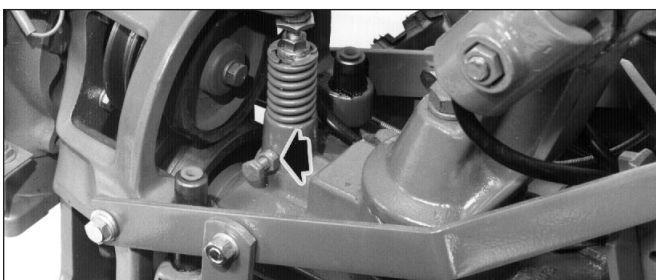

Figure 5-2: Check jam nut on plunger assembly.

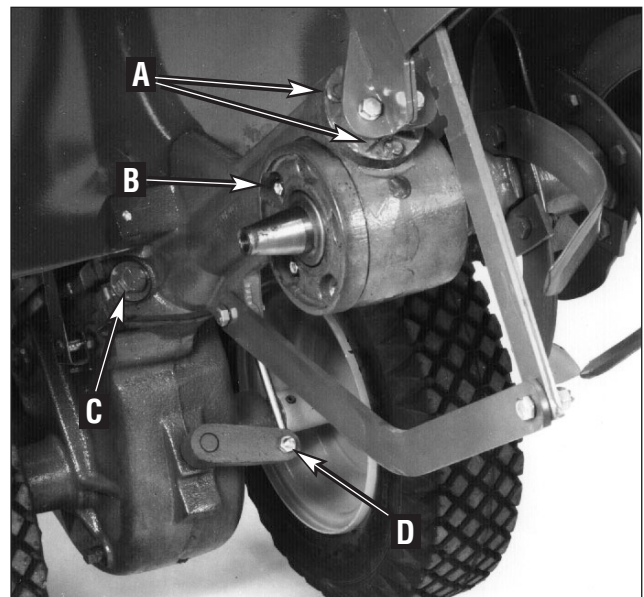
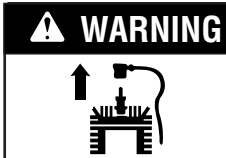

Figure 5-3: Gently tilt tiller forward to check fasteners.

Section 5: Maintenance



WARNING Before inspecting, cleaning or servicing the machine, shut off engine, wait for all moving parts to come to a complete stop, disconnect spark plug wire and move wire away from spark plug. Remove ignition key, if so equipped.

Failure to follow these instructions can result in serious personal injury or property damage.

IMPORTANT: Do not allow oil or grease to contact the pulleys, drive belt or reverse disc. This can cause the belt or disc to slip on the pulleys.

Lubricate the numbered areas in Figures 5-4 and 5-5, as follows:

1. Oil the wheel shaft between the wheel hubs and the transmission housing (A, Figure 5-4).
2. Oil all pivoting and connecting points on the Wheels/Tines/PTO Drive Lever and the Wheel Speed Lever (B, Figure 5-4).
3. Grease the face of the belt adjustment block (C, Figure 5-4).
4. Oil the Depth Regulator Lever, including the spring in the mounting bracket (D, Figure 5-4).
5. Oil the full length of the throttle cable casing (E, Figure 5-4).
6. Oil threads on Handlebar Height Adjustment Lever (F, Figure 5-4).

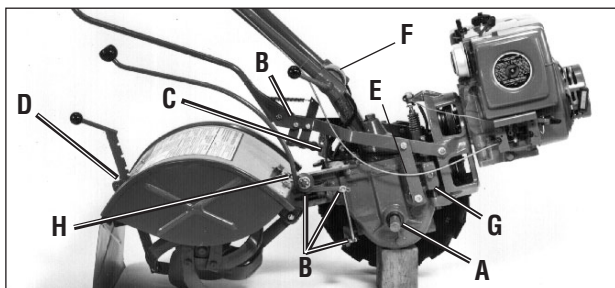

Figure 5-4: Tiller lubrication points (wheel removed for clarity).

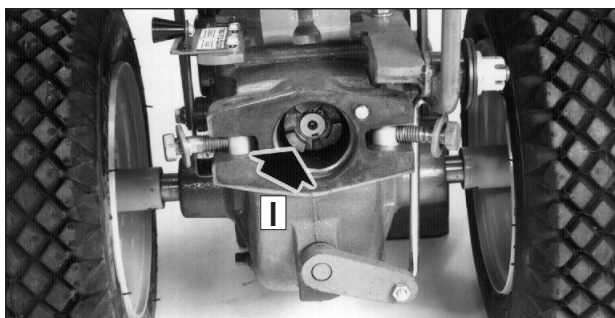

Figure 5-5: Use grease liberally in PTO access area.

7. Grease left- and right-side engine mounting bars at the top, the middle, and bottom (G, Figure 5-4).

8. Grease the zerk grease fitting located on the pivot point at the end of the Wheel Speed Lever (H, Figure 5-4). If Wheel Speed Lever has a grease fitting on pivot assembly, apply 2-to-3 strokes of multi-purpose grease at beginning and end of tilling season.

9. Keep the PTO access area well-greased (I, Figure 5-5). If the Tines/PTO Clutch Lever becomes hard to move, squirt some oil into its access hole, and work it back and forth to disperse the oil.

Transmission Gear

Oil Maintenance

Checking for Oil Leaks

At 25-hour operation intervals, check the tiller for oil leaks. Inspect for oil accumulations on the tiller or the floor where it's stored.

A small amount of oil seepage or wetness around a shaft opening or cover is no cause for alarm. But a heavy concentration of oil is more serious. You should tighten all bolts immediately, and replace any worn seals or gaskets.

It may be impossible to determine how much oil has been lost, so check the oil levels in the PTO transmission and the tine attachment before using the tiller again. Add any necessary gear oil. Serious damage to the transmission components can result from operation when gear oil levels are low.

If tilling during very hot weather, the gear oil may heat up and expand inside the transmissions. To allow for this oil expansion, both the power unit transmission and the tine attachment transmissions have oil relief vents (Figure 5-6).

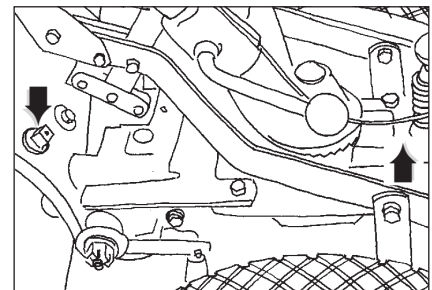

Figure 5-6: Oil relief vent locations.

The vents allow small amounts of oil to seep out.

If a serious leak is discovered, please contact your authorized dealer or the Factory Technical Service Department for service advice.

Checking Gear Oil Levels

Every 30 hours of operation, check the gear oil level in both the power unit transmission and the tine attachment transmission. Operating them while low on gear oil (even briefly) can cause serious damage to internal components.

Preparation

1. The transmissions must be cool, since hot gear oil expands and gives a false reading.
2. The power unit transmission and the tine attachment transmission must be connected when checking (or adding) gear oil.

Checking the Power Unit Oil Level

1. Move the tiller to level ground. Move the Depth Regulator up so the tines rest on the ground.
2. Use a 3/8" wrench to remove the oil level check plug on the left side of the transmission housing (Figure 5-7).

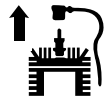
 <p>WARNING</p>	<p>Before inspecting, cleaning or servicing the machine, shut off engine, wait for all moving parts to come to a complete stop, disconnect spark plug wire and move wire away from spark plug. Remove ignition key, if so equipped.</p> <p>Failure to follow these instructions can result in serious personal injury or property damage.</p>
---	---

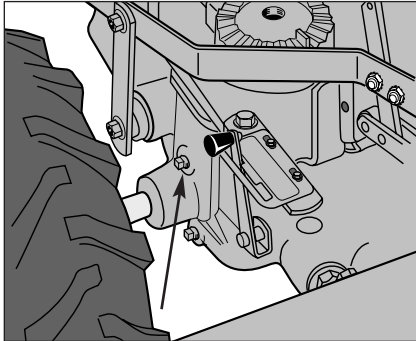

Figure 5-7: Remove oil level check plug. Gear oil should seep out if the level is sufficient.

3. If the oil level is correct, oil will seep out of the check hole (allow extra time in cold weather). If it does, the level is fine and you should replace the check plug. If no oil seeps out, see *Adding or Changing Gear Oil*.

Checking the Tine Attachment Oil Level

IMPORTANT: Two different gear oil checking procedures for the tine attachment transmission are described next. Use the first procedure if the dipstick in your tine attachment has only a 'Check Cold' marking. Use the second procedure if the dipstick has both cold and hot markings at the end. First remove the dipstick from the tine attachment transmission (Figure 5-8) to see which type dipstick you have. Then replace the dipstick with markings on dipstick facing to rear.

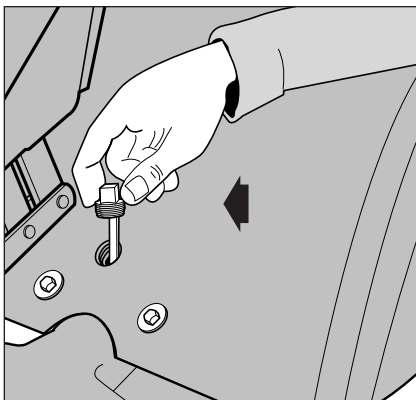

Figure 5-8: Checking gear oil level; markings on dipstick (tine attachment transmission) must face rear.

For Dipsticks With 'Check Cold' Marking

(Cold means 2 hours has passed since the tiller was used.)

1. Move the tiller to level ground.
2. Pull the Depth Regulator Lever back, then push it down all the way (to engage its top notch).
3. Place a sturdy support under the engine to prevent the tiller from tilting too far.
4. Now slide three pieces of 2" x 4" lumber underneath the drag bar— raising the drag bar about 4-1/2" above ground. This elevation allows an accurate "cold" gear oil reading .
5. Wait two hours with tiller elevated (allow more time if temperature is below 40°F).
6. Loosen and remove transmission dipstick (Fig. 5-8). Wipe it clean with a rag.
7. Hold dipstick so its markings face to rear of tiller. Lower it straight down into the sump hole to *touch* the drive shaft inside (Fig. 5-8). Don't force or try to thread it back in; an incorrect reading will result.
8. Remove dipstick and check oil level. It should be anywhere within the cross-hatched area or even slightly above the Max marking. If correct, replace dipstick and remove the boards used as props.
9. If oil level was low, gear oil must be added before using the tiller. See *Adding or Changing Gear Oil* next.

For Dipsticks With Hot/Cold Markings

1. Move the tiller to level ground.
2. Pull the Depth Regulator Lever back, then push it down all the way (to engage its top notch).
3. Place a sturdy support under the engine to prevent the tiller from tilting too far.

4. **Cold reading** (preferred method): (Two hours has passed since the tiller was used.) Place a 2" x 4" board (on edge) under the drag bar— raising the tiller and drag bar about 3-1/2" above ground. **Hot reading:** (Tiller was operated for more than 30 minutes within the past hour.) Do not use the wood prop to elevate the tiller.
5. Follow Steps 4, 5 and 6 given for the other dipstick type.
6. Remove dipstick and check level. It should be within or above the "Cold" range marking if taking a cold reading. If taking a hot reading, the level should be within or slightly above the "Hot" range.
7. If the level is incorrect, see *Adding or Changing Gear Oil*.

Adding or Changing Gear Oil

For partial fill-ups (just a few ounces or less), use SAE 140, SAE 85W-140, or SAE 80W-90 weight gear oil with an API rating of GL-4 or GL-5. For full replacement, use SAE 140 or SAE 85W-140 gear oil with an API rating of GL-4 only. (At the factory, SAE 85W-140 weight gear oil is used.)

IMPORTANT: Do not use automatic transmission fluid or engine oil. They are too light in weight and will result in transmission damage.

The gear oil does not need to be changed. Do so only if you know, or suspect, it is contaminated with dirt, sand or other foreign particles.

Gear oil is available at authorized dealers and most service stations, power equipment centers, or farm/heavy equipment outlets.

Capacities: Power unit transmission holds approximately 60 ozs.; Tine Attachment transmission holds approximately 12-1/2" ozs.

Section 5: Maintenance

WARNING

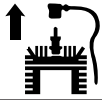

Before inspecting, cleaning or servicing the machine, shut off engine, wait for all moving parts to come to a complete stop, disconnect spark plug wire and move wire away from spark plug. Remove ignition key, if so equipped.

Failure to follow these instructions can result in serious personal injury or property damage.

Adding Gear Oil to the PTO Power Unit Transmission

1. Do steps 1 and 2 of *Checking the Power Unit Oil Level* on page 32.
2. Using a 3/4" wrench (or socket), remove the bolt securing the handlebar base to the top of the transmission (prop the handlebars first to prevent them from falling).
Then, unplug the Forward Interlock wire harness receptacle at the bottom of the handlebars. Set the handlebar base and bolt aside on a clean surface. The bolt hole in the top of the transmission is the gear oil fill hole (A, Figure 5-9).

3. Slowly pour gear oil through a clean funnel into the transmission. Stop when gear oil begins to flow from the oil level check hole on the left side of the transmission (B, Figure 5-7).

4. Reinstall the oil level check plug. Tighten it securely.
5. Reinstall the handlebars using the mounting bolt previously removed. Align the handlebars so they point straight backwards, not at an angle. Then tighten the mounting bolt securely.
6. Reconnect the Forward Interlock wire harness to the receptacle. Be certain it's secure.
7. Test operation of the Forward Interlock Safety System. See Section 4 for a procedure.

Draining and Filling the PTO Power Unit Transmission

1. Place a shallow pan under the transmission gear oil drain plug (B, Figure 5-9).
2. Remove the oil level check plug (Figure 5-7) with a 3/8" wrench. This vents the transmission for faster oil draining.

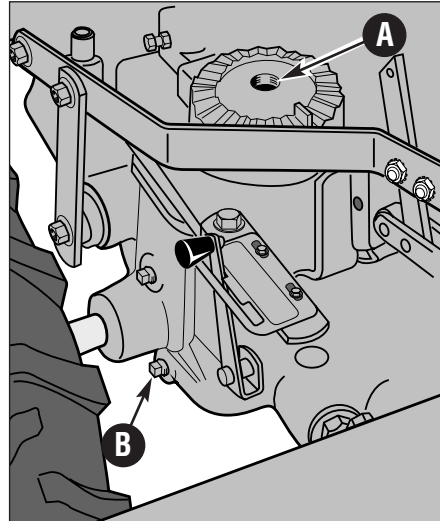

Figure 5-9: Gear oil fill hole (A) and gear oil drain location (B).

3. Using the 3/8" wrench, remove the drain plug (B, Figure 5-9). The gear oil will drain quite slowly since it is thick. After about two quarts have drained, tilt the tiller forward so any oil at the rear of the transmission will drain out.
4. Clean the drain plug threads, put non-hardening gasket sealant on the threads, and reinstall plug.
5. Refill the transmission with the correct amount of gear oil before operating the tiller again. When oil seeps from the oil level check hole, the right amount of gear oil has been added. Replace all plugs.

Adding Gear Oil to the Tine Attachment Transmission

1. Select the right Depth Regulator Lever setting:
 - a. If filling an empty transmission, raise the Depth Regulator Lever so tines are on the ground.
 - b. If topping off the gear oil, move Depth Regulator Lever down to engage its top notch.
2. Remove dipstick from tine attachment (Figure 5-8).

3. Slowly add gear oil in the dipstick hole. Add 1/2-ounce at a time to avoid overfilling. It takes about 12-1/2 ounces.
4. Take dipstick readings frequently. Stop when oil reaches "Cold" range marking on dipstick. Replace dipstick securely.

Draining and Filling the Tine Attachment Transmission

1. The tine attachment transmission is not equipped with an oil drain plug. To drain just a small amount of gear oil, remove the dipstick and tilt the attachment forward (first uncoupling it from the Power Unit).
2. For complete drainage, remove the left-side tine assembly (refer to Bolo Tine Maintenance for instructions), then remove just one of the lower screws from the tiller housing cover (Figure 5-10). To speed drainage, remove the tine attachment dipstick to vent transmission.

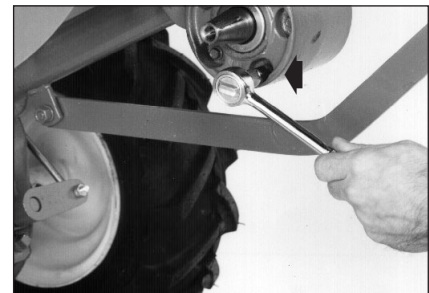
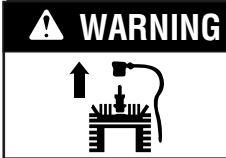

Figure 5-10: Remove housing cover screw to drain tine attachment transmission gear oil.

NOTE: If you find a plastic washer on the cover screw you remove, discard the washer. There is no need to install a replacement washer.

3. Once all gear oil has drained, reinstall the housing cover screw securely (first coat its threads with non-hardening gasket sealant).
4. Be certain to refill the transmission with the correct amount of gear oil before operating the tiller again.



WARNING

Before inspecting, cleaning or servicing the machine, shut off engine, wait for all moving parts to come to a complete stop, disconnect spark plug wire and move wire away from spark plug. Remove ignition key, if so equipped.

Failure to follow these instructions can result in serious personal injury or property damage.

Drive Belt Maintenance Measuring and Adjusting Drive Belt Tension

On a new tiller (or if a new belt is installed), the belt tension will probably need to be adjusted after the first two (2) hours of operation. Thereafter, check belt tension every ten (10) operating hours.

Maintaining the right tension is important to good tiller performance and long belt life. If too loose, the belt will slip on the pulleys, and be unable to deliver full power to the wheels and tines. A loose belt will also wear prematurely.

While checking belt tension, also inspect the belt for cuts, cracks, deterioration, etc. Don't continue using a belt that isn't in good shape. You're sacrificing tiller performance by doing so.

Tips on keeping the drive belt in top condition include:

- Always put the Wheels/Tines/PTO Drive Lever in NEUTRAL when the tiller is not in use.
- Keep tension adjusted correctly.
- Don't "speed shift" when moving the Wheels/Tines/PTO Drive Lever between FORWARD and REVERSE.

How to Measure Belt Tension

1. Before taking a measurement, be sure the linkages and pivot points on the Wheels/Tines/PTO Drive Lever are clean and lubricated. If there is any binding, you won't get true measurements. Also, you'll need the belt adjustment tool you received with your new tiller (Figure 5-11).

2. Move the Wheels/Tines/PTO Drive Lever fully down to the FORWARD position. The clutch roller at the bottom of the lever should be positioned underneath the belt adjustment block (Figure 5-12). Don't let the clutch roller move during the next few steps. If it moves, you'll get a false belt tension reading.

3. The belt tension is correct if the front of the clutch roller is 1/4"-to-5/16" away from the face of the upright bracket that holds the adjustment block in place (Figure 5-12). To measure this distance:

- Without moving the clutch roller, try inserting the 1/4"-thick, slotted end of the belt adjustment tool in between the roller and the upright bracket. (The flat edge of the tool must be facing the roller.) Refer to Figure 5-13.
- If only the *slotted* portion of the tool will fit, the belt tension is correct.
- If the slotted part of the tool will not fit in, the belt is too loose.
- If the full thickness (5/16") of the tool easily fits in, the belt is too tight.

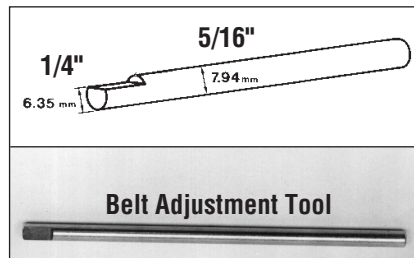

Figure 5-11: Use this belt adjustment tool to measure and adjust drive belt tension.

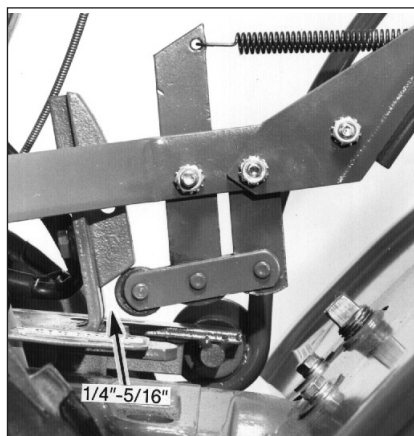

Figure 5-12: Shift into FORWARD and measure distance between roller and upright bracket using the belt adjustment tool.

4. If the belt tension is correct, move the Wheels/Tines/PTO Drive Lever back to NEUTRAL.

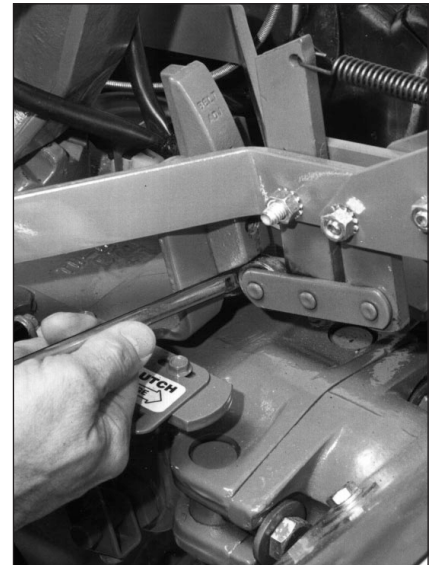

Figure 5-13: Insert slotted end of belt adjustment tool between roller and bracket, with the flat side of the slotted end facing the roller.

How to Adjust Belt Tension

1. As described in the following steps, drive belt tension is adjusted by moving the adjustment block up or down. Moving it down will tighten the belt; moving it up loosens the belt.

HINT: The distance the block moves approximately equals the distance the roller moves.

In most cases, the clutch roller will not have been very far out of position, so the adjustment block will only need to be moved slightly (up or down).

2. Move the Wheels/Tines/PTO Drive Lever to NEUTRAL position. The clutch roller will come to rest anywhere on the face of the belt adjustment block, depending upon drive belt length and current belt tension adjustment.

Section 5: Maintenance

WARNING

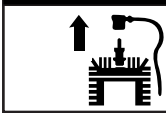

Before inspecting, cleaning or servicing the machine, shut off engine, wait for all moving parts to come to a complete stop, disconnect spark plug wire and move wire away from spark plug. Remove ignition key, if so equipped.

Failure to follow these instructions can result in serious personal injury or property damage.

3. Insert the belt adjustment tool through the hole in the side of the adjustment block, spacing the ends of the tool equally on both sides (Figure 5-14). Rotate the tool so the slotted end faces down.

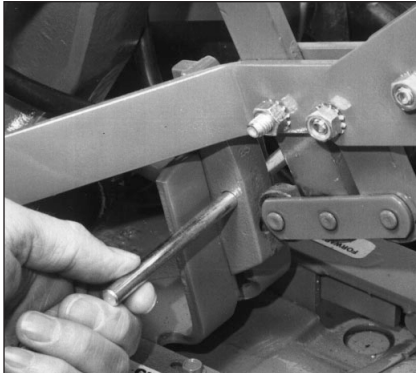

Figure 5-14: With Wheels/Tines/PTO Drive Lever in NEUTRAL, insert tool through hole in adjustment block.

4. Place the Wheels/Tines/PTO Drive Lever in FORWARD position. The arms of the clutch control yoke will be resting on the belt adjustment tool and the clutch roller should be engaged slightly beneath the adjustment block (Figure 5-15).

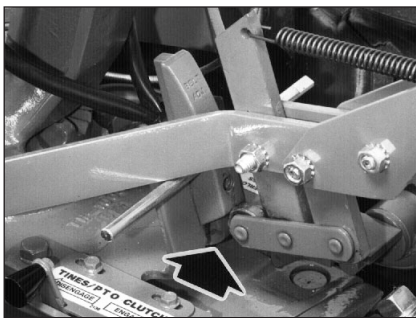

Figure 5-15: With Drive Lever in FORWARD position, clutch roller should be engaged slightly beneath the adjustment block.

5. Use one hand to hold the drive lever in FORWARD while using a 9/16" wrench to loosen (don't remove) the bolt at the back of the belt adjustment block (Figure 5-16). The adjustment block should be free to move either up or down.



Figure 5-16: Hold Drive Lever while loosening bolt. Push lever down to tighten belt; pull up to loosen belt.

6. Push the drive lever down if the belt needs tightening. Pull the lever up if the belt needs to be loosened. Hold the drive lever in place and tighten the bolt in the adjustment block firmly.

7. Let go of the drive lever and remove the belt adjustment tool from the hole in the adjustment block.

8. Check the tension on the belt by following the previous instructions "How to Measure Belt Tension."

NOTE: If the adjustment block is all the way down and the measurement between the clutch roller and the bracket is less than 1/4", then a new drive belt is needed.

Replacing the Drive Belt

Removing the Belt

1. Move Wheels/Tines/PTO Drive Lever to NEUTRAL position.

2. While kneeling on the right side of the tiller, create slack in the belt by reaching over to the left side of the pulleys and pushing in on the center of the belt with your finger.

3. Use your right hand to move the belt down and away from the lower pulley, in the direction of the engine (Figure 5-17).

4. Push the belt upward to create slack in the belt (Figure 5-18).



Figure 5-17: First move belt off the lower pulley.

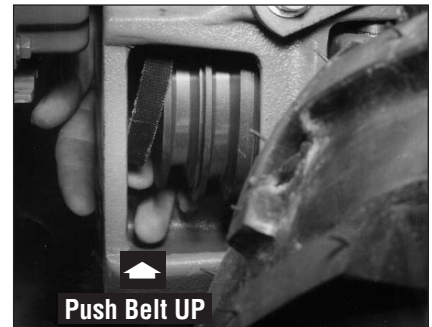

Figure 5-18: Push belt upward to create slack.

5. Lift the top half of the belt up and over the upper pulley and the rubber reverse disc, moving it in front of the reverse disc (refer to Figure 5-19).

6. Push the Wheels/Tines/PTO Drive Lever down into the FORWARD position. This increases the distance between the upper and lower pulleys. Next, lift and pull the entire belt out between the pulleys (Figure 5-20).

Replacing the Drive Belt

1. Place Wheels/Tines/PTO Drive Lever in FORWARD position.

2. Squeeze the belt in the middle and insert one end in between the pulleys (Figure 5-20).

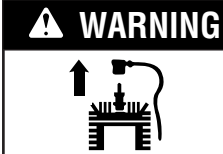

WARNING

Before inspecting, cleaning or servicing the machine, shut off engine, wait for all moving parts to come to a complete stop, disconnect spark plug wire and move wire away from spark plug. Remove ignition key, if so equipped.

Failure to follow these instructions can result in serious personal injury or property damage.



Figure 5-19: Move top half of belt over pulley and reverse disc.



Figure 5-20: Shift into FORWARD and remove the belt.

3. Push belt forward then down until it is looped over the lower pulley (Figure 5-18). Do not yet seat it in either of the lower pulley's grooves.

HINT: A blunt object, like a ruler, can help you push the belt downward if needed.

4. Move the top half of the belt up and over the rubber reverse disc, but do not seat it in either of the grooves in the top pulley.

5. Place the Wheels/Tines/PTO Drive Lever in NEUTRAL.

6. Move the top half of the belt into the HIGH Range groove (groove closest to the engine) on the top pulley (Figure 5-21).

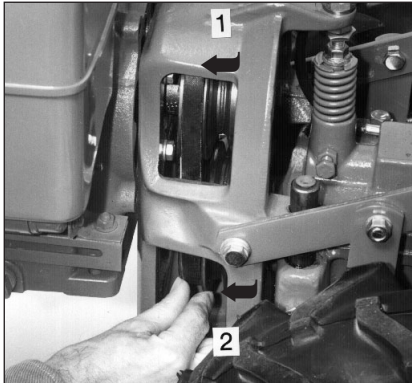

Figure 5-21: Seat belt in upper pulley, then in lower pulley (High Range position shown).

7. Move the bottom half of the belt into the HIGH Range groove of the lower pulley (groove closest to engine— Figure 5-21). If extra slack is needed, hold up Wheels/Tines/PTO Drive Lever while moving the belt. Verify the belt is seated properly on the pulleys.

8. To move the belt to the LOW Range position, see *Changing Belt Speeds* in Section 4.

9. After installing the belt, check and adjust for correct belt tension as explained previously.

Reverse Drive System Maintenance

These instructions explain how to inspect, replace or adjust the various reverse drive components.

But first, here's how the reverse drive system works: When you raise the Wheels/Tines/PTO Drive Lever up in REVERSE position, this lowers the rubberized reverse disc (it's attached to the engine drive pulley) until this rotating disc contacts the transmission drive pulley. The friction between the rotating reverse disc and the transmission pulley causes the transmission drive shaft to be powered in a counterclockwise direction (as viewed from the operator's position behind handlebars). The drive shaft then turns the wheels and tine shafts in a reverse direction.

Reverse Disc Inspection

The reverse disc is made of steel with a special, long-lasting rubber compound bonded to the disc rim. Since this is a wearing part, it should be inspected after every 30 operating hours.

1. Measure the width of the outside edge of the disc as shown in Figure 5-22. Replace the disc before the rubber edge wears to a thickness of 1/8" or less. Failure to do so could cause the steel underneath the rubber to damage the transmission pulley.

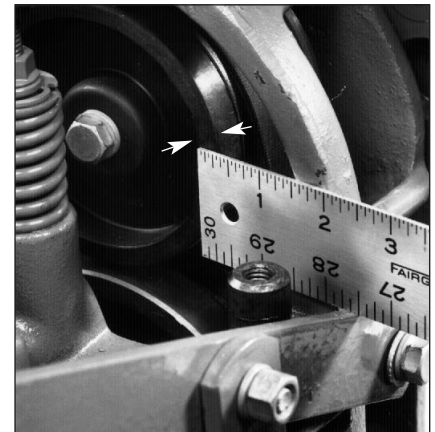

Figure 5-22: Measure the edge of the reverse disc for wear.

2. Look for big cracks or missing chunks of rubber from the disc. If so damaged, the disc should be replaced immediately.

IMPORTANT: Extend the life of the reverse disc by always pausing in NEUTRAL before shifting between FORWARD and REVERSE. Also – the reverse disc is not suited for continuous or sustained reverse operation. Use reverse sparingly.

Section 5: Maintenance

WARNING

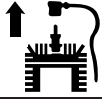

Before inspecting, cleaning or servicing the machine, shut off engine, wait for all moving parts to come to a complete stop, disconnect spark plug wire and move wire away from spark plug. Remove ignition key, if so equipped.

Failure to follow these instructions can result in serious personal injury or property damage.

Replacing the Reverse Disc

Follow these steps to replace the reverse disc. (If your tiller has a Bumper Attachment mounted, it must be removed first.)

Removing the Reverse Disc

1. Move Wheels/Tines/PTO Drive Lever in NEUTRAL position.
2. Wedge a 5/16"-thick board between top of engine pulley (avoid contacting reverse disc) and cast iron housing next to it. This immobilizes pulley.
3. Use a 9/16" wrench to loosen the mounting bolt shown in Figure 5-23. Remember to immobilize the pulley with the wood wedge while loosening the bolt. If necessary, pry the disc from the pulley with the tip of a screwdriver. Back the bolt out as far as possible. Then angle the disc a little to remove it. Bring the bolt and lockwasher along with the disc.

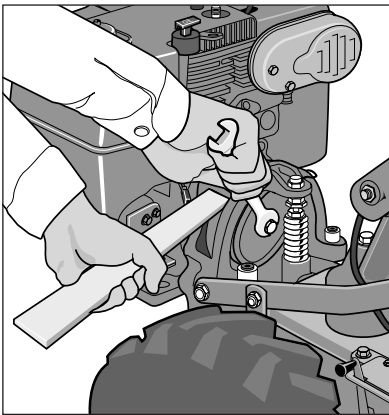

Figure 5-23: Removing Reverse Disc.

Installing a New Reverse Disc

1. Do steps 1-through-3, described previously, in reverse.
2. Tighten mounting bolt securely, and check for correct operation — see *Checking and Adjusting Reverse Drive System*.

Checking and Adjusting Reverse the Drive System

When the Wheels/Tines/PTO Drive Lever is moved up into REVERSE, the engine

and engine mount move down to press on the reverse adjustment bolt (Figure 5-24). This action compresses the reverse spring and plunger assembly, requiring you to hold the lever up in REVERSE.

When you release the lever, the spring automatically pushes the lever back into NEUTRAL position.

The spring and plunger assembly is designed to prevent the reverse disc from making contact with the transmission pulley until you shift into REVERSE. When the lever is in NEUTRAL, the switch body on the bottom of the engine mount tab should be resting squarely on top of the reverse adjustment bolt (Figure 5-24). The reverse adjustment bolt can be adjusted up or down to correct a number of reverse drive operating problems, as explained next.

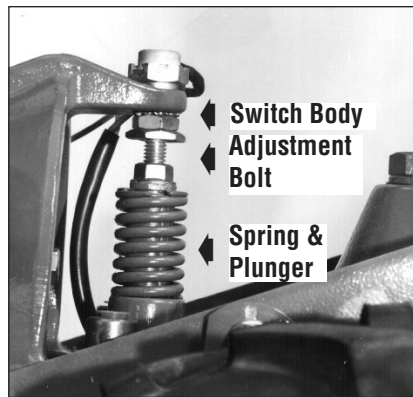

Figure 5-24: Spring and plunger assembly.

Checking and Adjusting Reverse Disc

1. Verify that linkages for Wheels/Tines/PTO Drive Lever are lubricated with oil and engine mount bars and belt adjustment block are lubricated with grease. (See *Tiller Lubrication* in this section.)
2. Place Wheels/Tines/PTO Drive Lever in NEUTRAL. Briefly pull out engine recoil start rope while watching reverse disc. The disc should turn, but lower pulley should not (Figure 5-25). If reverse disc turns lower pulley, or if it is located closer than 3/16" to the pulley, reverse adjust-

ment bolt should be adjusted upward (see instructions that follow). Moving adjustment bolt upward will also solve problem of a tiller that goes into REVERSE on its own.



Figure 5-25: Checking Reverse Disc in NEUTRAL.

3. Use your left hand to hold Wheels/Tines/PTO Drive Lever up in REVERSE, while briefly pulling out engine start rope. The reverse disc should turn lower pulley (see Figure 5-26). If not, or it requires a lot of pressure to hold lever up in REVERSE, then reverse adjustment bolt must be adjusted downward. When correctly adjusted, the Wheels/Tines/PTO Drive Lever should pop out of reverse when the lever is released, but not require exceptional effort to hold it up in reverse position.

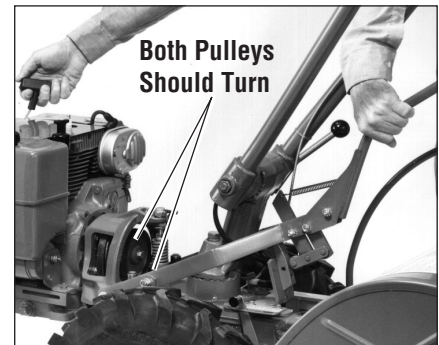
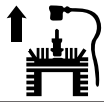

Figure 5-26: Checking Reverse Disc in REVERSE.

4. Shift the Wheels/Tines/PTO Drive Lever to REVERSE and then let it go. The lever should return to NEUTRAL. If not, the reverse adjustment bolt will have to be adjusted upward.

⚠ WARNING



Before inspecting, cleaning or servicing the machine, shut off engine, wait for all moving parts to come to a complete stop, disconnect spark plug wire and move wire away from spark plug. Remove ignition key, if so equipped.

Failure to follow these instructions can result in serious personal injury or property damage.

Adjusting Reverse Drive:

1. Place Wheels/Tines/PTO Drive Lever in FORWARD position.
2. On left side of tiller, put a 1/2" wrench on the plunger retaining bolt and another 1/2" wrench on the jam nut next to it (Figure 5-27). While holding the bolt steady, loosen the jam nut (counterclockwise) until it touches the bolt head.

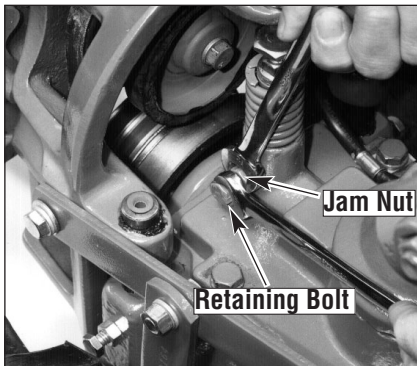

Figure 5-27: Hold bolt steady while loosening or tightening jam nut.

3. Turn the bolt in until it tightens against the plunger inside the spring. The bolt must be tight to prevent plunger from turning – but be careful not to overtighten and break the bolt.
4. Place a 7/8" wrench on the head of the reverse adjustment bolt and a 9/16" wrench on the jam nut below it (Figure 5-28). Hold the bolt steady while loosening the jam nut three or four turns.
5. Move the Wheels/Tines/PTO Drive Lever to NEUTRAL. The switch body on the bottom of the engine mount tab (Figure 5-24) should be resting squarely on top of the reverse adjustment bolt, and the reverse disc should be at least 3/16" away from the transmission drive pulley. If the reverse disc is any closer than this, raise the reverse adjustment bolt (turn it counterclockwise).
6. Check that reverse disc is at least 3/16" away from transmission drive pulley. Then hold reverse adjustment bolt steady with one wrench while tightening jam nut with a second wrench (Figure 5-28).

7. Place a chalk or pencil mark on the top edge of the plunger retaining bolt. Now, while watching the mark, loosen the bolt 3/4-turn (Figure 5-29). Do not exceed a 3/4 turn (this would disengage the bolt from the locking groove in the side of the plunger).

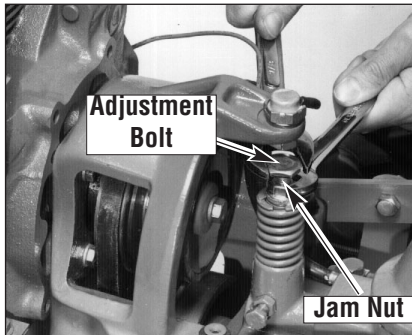

Figure 5-28: Loosen jam nut before turning reverse adjustment bolt.

8. Hold the plunger retaining bolt steady with a wrench while tightening the jam nut against the side of the plunger housing (Figure 5-27).

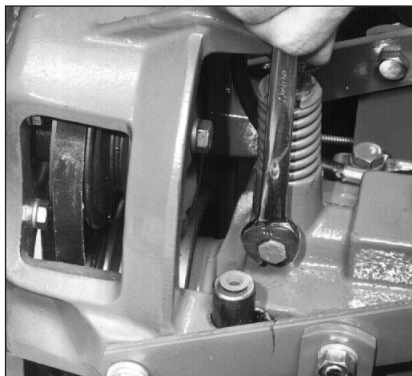

Figure 5-29: Loosen plunger retaining bolt about 3/4-turn, then tighten jam nut against plunger housing.

9. Check the action of the reverse disc as explained previously.

IMPORTANT: If the above adjustments have not corrected an improperly working reverse drive, contact an authorized dealer or Factory Technical Service Department for assistance.

Bolo Tine Maintenance

Checking Tines for Wear

Inspect the tines for wear or damage after every 30 operating hours. The rate of wear depends upon hours of use and soil conditions. With use, the tines get shorter, narrower and more pointed (Figure 5-30). If badly worn, they lose the ability to till deeply.



Figure 5-30: Check for wear every 30 operating hours.

Worn tines leave an ever-increasing gap in the middle of a tilled row. The normal gap is 3" between the tine tips – replace the tines when the gap widens to 5" (Figure 5-31).

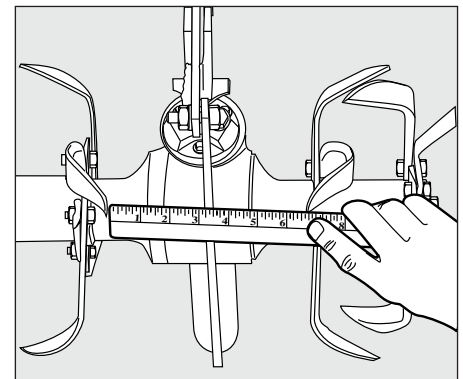
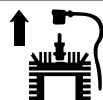

Figure 5-31: Replace tines when gap between inner tines is 5" or more (normal gap is 3").

Tines can be replaced individually or as a complete set. See replacement instructions that follow.

Section 5: Maintenance

⚠ WARNING



Before inspecting, cleaning or servicing the machine, shut off engine, wait for all moving parts to come to a complete stop, disconnect spark plug wire and move wire away from spark plug. Remove ignition key, if so equipped.

Failure to follow these instructions can result in serious personal injury or property damage.

Single Tine Replacement

⚠ WARNING

The tines or tine hood edges may be sharp. Wear thick gloves to protect your hands from cuts or scrapes.

1. Move the Wheels/Tines/PTO Drive Lever to NEUTRAL, the Wheel Speed Lever to either FAST or SLOW position, and the Tines/PTO Clutch Lever to ENGAGE.
2. Gently tilt the tiller forward until the engine rests on the ground.
3. Raise the hood flap at the back of the tiller and tie it up with string.
4. Before removing a tine, note in which direction the bent tip points. The new tine must be installed in the same direction.
5. Use two 9/16" wrenches to remove the two bolts and nuts securing the tine to the tine holder plate (Figure 5-32). Use penetrating oil on the hardware if it is rusted or hard to remove.

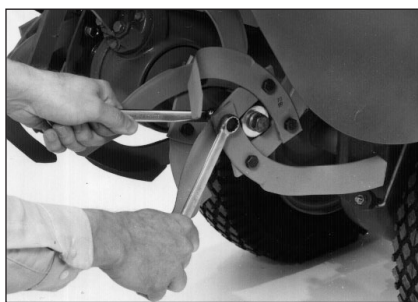

Figure 5-32: Removing a single tine requires taking off two bolts and two nuts.

6. Mount the new tine exactly the way the old tine was positioned. (The sharp edge of the tine, which enters the soil first, must face forward when above the tine shaft.) Replace the bolts and nuts and tighten them securely.

Removing and Replacing A Tine Holder Assembly

⚠ WARNING

- The tines or tine hood edges may be sharp. Wear thick gloves to protect your hands.
- Wear safety goggles to protect your eyes. When loosening hardware, do not hit a wrench with a metal tool— this could shatter the tool or wrench, sending metal particles into your eyes.

The 16 Bolo Tines are mounted eight per side on left-side and right-side tine holders. Here's how to replace the tines and holders as assemblies.

Removing Tine Holder Assembly

1. Follow steps 1-through-3 in *Single Tine Replacement* above.
2. Identify the tine holders as left-side and right-side holders – they must be replaced on the same side from which they were removed. Use a piece of chalk or a grease pencil to mark them L and R.

3. Remove the two bolts and nuts securing each holder (Figure 5-33).
4. Use a soft mallet to drive the holder off the tine shaft. (Use a heavy hammer and block of wood to knock off the immobilized tine holder.)
5. When the holder is off, clean all dirt and debris from the shaft and the holder. Apply fresh grease to the tine shaft.

Replacing Tines Holder Assembly

1. Replace the holder so the sharp tine edges face forward (toward front of tiller). Tap tine holder back on the tine shaft.
2. Grease the threads on the mounting bolt(s). Install and tighten the bolt(s) securely.

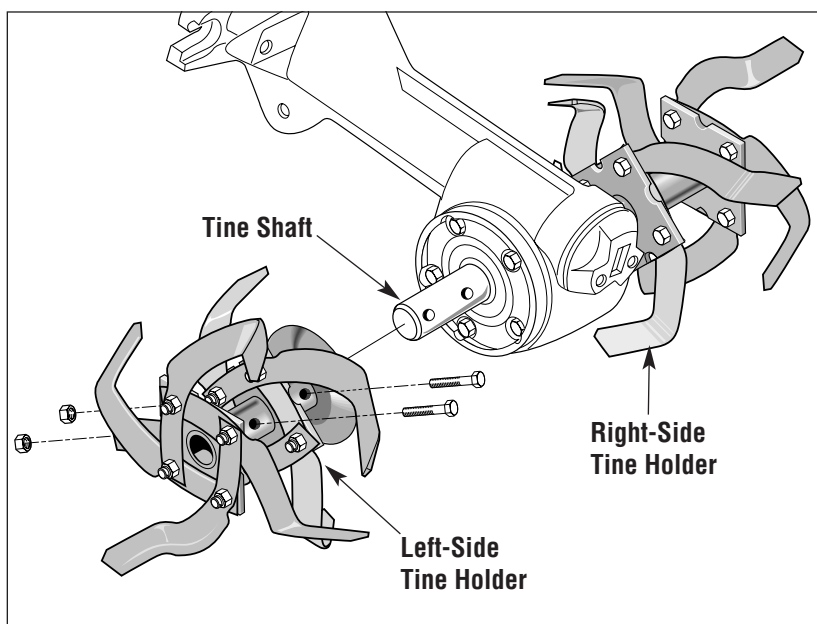
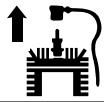

Figure 5-33: Tine Holders.

WARNING



Before inspecting, cleaning or servicing the machine, shut off engine, wait for all moving parts to come to a complete stop, disconnect spark plug wire and move wire away from spark plug. Remove ignition key, if so equipped.

Failure to follow these instructions can result in serious personal injury or property damage.

Tine Shaft Maintenance

After every 10 operating hours, remove the left- and right-side Bolo Tine holders and clear away dirt and debris that have accumulated on the tine shaft or inside the tine holders. Please follow this maintenance recommendation, as debris can cause premature wear to the tine shaft and its oil seals. Refer to the previous tine holder removal instructions. After cleaning away any debris and removing old grease from the tine shaft, apply fresh grease to the tine shaft.

Tire and Wheel Maintenance

Check tire air pressure every 30 operating hours. The recommended pressure for tilling is 10-to-20 psi (pounds per square inch). Both tires should be inflated equally. (Unequal pressure can cause the tiller to pull to one side.)

Removing the Wheels

Each wheel is secured by a roll (spiro) pin that passes through the wheel hub and the wheel shaft. Drive the roll pin out to remove a wheel.

1. Prop the transmission up with a sturdy block to raise the wheel you want to remove off the ground.
2. Move the Wheel Speed Lever to either SLOW or FAST position to prevent the wheels from turning.
3. Use a 5/16" drift pin (or a blunt point 16-penny nail) to drive the roll pin free.

WARNING

Wear safety goggles when driving the roll pin into or from the wheel hub to protect your eyes from the possibility of flying metal particles.

Engine Oil Maintenance

Check the engine oil level before starting the engine each day and after each 5 hours of continuous operation. Running the engine when it is low on oil will quickly ruin the engine.

It is recommended that you change the oil every ten (10) operating hours and even sooner when operating in extremely dirty or dusty conditions. Refer to the separate Engine Owner's Manual for detailed service instructions.

Air Cleaner Maintenance

The engine is equipped with a dual element air cleaner that filters the air twice before it enters the carburetor to mix with the fuel.

The engine air cleaner filters dirt and dust out of the air before it enters the carburetor. Operating the engine with a dirty, clogged air filter can cause poor performance and damage to the engine. Never operate the engine without the air cleaner installed. Inspect and service the air cleaner more often if operating in very dusty or dirty conditions.

It is critical that the filters be kept clean and properly installed at all times. See the location of the air cleaner assembly on your engine by referring to Figure 5-39 or Figure 5-40.

Refer to the engine manufacturer's literature supplied with your tiller for complete air cleaner service and maintenance information.

Throttle Cable Maintenance

The throttle lever settings are factory-adjusted, so unnecessary adjustments should not be made. However, if the engine does not start or stop, or respond immediately to various throttle lever settings, then adjustments may be necessary. Please refer to the engine manufacturer literature supplied with your tiller for specific adjustment instructions.

Ignition System Maintenance

Your engine is equipped with electronic ignition. It does not have a condenser or points, so there is no need to perform any regular tune-up maintenance on this system other than adjusting or replacing the spark plug.

Spark Plug Maintenance

The spark plug must be in good condition for proper engine operation. Remove and inspect the plug every 50 operating hours or annually, whichever occurs first.

The correct electrode gap is .030". Check the gap with a feeler gauge. Do not use a spark plug if the porcelain is cracked, the electrodes are pitted or burned, or if other visible damage is present.

NOTE: Do not wire brush or sandblast the spark plug to clean it – loose particles can enter the engine, causing damage!

To replace the plug, first tighten it securely by hand, then use a spark plug wrench to tighten the plug an extra 1/4 turn.

Battery Care and Maintenance

The battery is sealed and is maintenance-free. Acid levels cannot be checked.

- Always keep the battery cables and terminals clean and free of corrosive build-up.
- After cleaning the battery and terminals, apply a light coat of petroleum jelly or grease to the terminals and cover both terminals with the rubber boots.

WARNING

When removing the battery, always disconnect the negative (-) cable first followed by the positive (+) cable. Reverse this procedure when reinstalling the battery.

Section 5: Maintenance

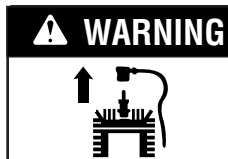

WARNING Before inspecting, cleaning or servicing the machine, shut off engine, wait for all moving parts to come to a complete stop, disconnect spark plug wire and move wire away from spark plug. Remove ignition key, if so equipped.

Failure to follow these instructions can result in serious personal injury or property damage.

Storing Your Tiller

When your tiller won't be used during the off-season, prepare it for storage with the following steps:

1. Clean the tiller and engine.
2. Do routine tiller lubrication and check for loose hardware.
3. Protect the engine from deterioration or damage by referring to the engine storage instructions in your engine manual literature.
4. When engine is still warm, drain oil from engine crankcase. Refill with fresh motor oil.
5. Protect internal cylinder against rust by removing spark plug and pouring one ounce of clean engine oil into spark plug hole. Then slowly pull out recoil start rope 2 or 3 times to distribute oil internally. Replace spark plug, but do not reconnect plug wire. Pull rope until resistance is felt — let rope rewind.
6. Charge battery (electric start option). Store battery in cool, dry location.
7. Move Wheels/Tines/PTO Drive Lever to NEUTRAL position. Keep tiller in a clean, dry area.
8. Never store tiller with fuel in fuel tank in an *enclosed* area where gas fumes could reach an open flame or spark, or where ignition sources are present (space heaters, hot water heaters, furnaces, etc.).

Inspecting Forward Interlock Wiring System

Check the Forward Interlock wiring system every ten (10) operating hours, for tight connections and to see that the insulation on the wires is unbroken (to prevent the system from shorting out).

1. Check insulated wire harness from lower ends of handlebars to wire harness connector on top, right side of transmission cover. Be sure connector is secure.
2. Check insulated tubing from connector to cast iron motor mount/belt shroud.
3. Check the wire leading from the tubing over to the switch assembly mounted on top of the tab on the cast iron motor mount—belt shroud. Also check the second wire that leads to the throttle cable mounting bracket on the right side, forward portion of the engine.

Testing the Forward Interlock Wiring System

The wiring circuit for the Forward Interlock Safety System is designed to ground out the engine's ignition system.

There are three switches in the circuit which, when open, let the engine run. One switch is on the neutral plunger tab of the cast iron motor mount. This switch is open whenever the Wheels/Tines/PTO Drive Lever is in NEUTRAL or REVERSE positions. The other two switches are located inside the handlebars, directly above the two Forward Interlock Levers.

The switches are wired so when squeezed (open) the engine will run. There is a fourth switch located in the wiring harness connector on the top, right side of the transmission cover. It warns you if the connection is not mated by not letting the engine run while the Wheels/Tines/PTO Drive Lever is in FORWARD.

1. A broken or disconnected wire could let the engine run without you having to press one of the Forward Interlock Levers.
2. A bare wire touching tiller or engine metal could ground out the engine's ignition.
3. A switch that has failed allows the engine to run. Or it may prevent the engine from running.

Refer to the *Troubleshooting* section if your Forward Interlock Safety System is not operating correctly.

CHECK OR TEST (Check or test in sequence shown until problem is resolved.)	PROBLEM		
	Engine won't start	Engine shuts off when Wheels/Tines/PTO Drive Lever is shifted into FORWARD	Engine does not shut off when Forward Interlock Levers are released while Wheels/Tines/PTO Drive Lever is in FORWARD
Throttle Lever in START position	X		
Wheels/Tines/PTO Drive Lever in NEUTRAL position	X		
Forward Interlock Wire Harness connector securely mated		X	X
Forward Interlock Levers not being squeezed prior to shifting Wheels/Tines/PTO Drive Lever to FORWARD position		X	
Visually inspect for bare, broken or disconnected wires	X		X
Check handlebar wire harness	X		X
Check transmission wire harness	X		X

Troubleshooting Procedures

1 Wheels/Tines/PTO Drive Lever:

A. Lever does not stay in FORWARD–

- Drive belt may be too tight. Raise belt adjustment block a little (Sect. 5).
- Clutch pawl spring at end of lever may be overstretched. Install new spring.

B. Lever hard to shift into REVERSE–

- Check reverse disc for wear (Sect. 5).
- Check adjustment of reverse disc and/or reverse spring and plunger assy. (Sect. 5).
- Clean and re-lubricate motor mount bars, belt adjustment block and linkages on lever (Sect. 5).

C. Tiller stays in REVERSE when lever is released–

- Lubricate motor mount bars, belt adjustment block and linkages on lever (Sect. 5).
- Check adjustment of reverse spring and plunger (Sect. 5). If problem persists, contact Technical Service Department.

D. Lever sticks in FORWARD–

- Lubricate motor mount bars, belt adjustment block, and linkages on lever (Sect. 5). If problem continues, contact the Technical Service Department.

E. Lever hard to shift into FORWARD–

- Follow advice for Problem 1-D. Also check for possible bent motor mount bar that could be binding in engine mount holes.

2 Wheel Speed Lever:

A. Lever hard to shift, or sticks in FAST or SLOW wheel gear positions–

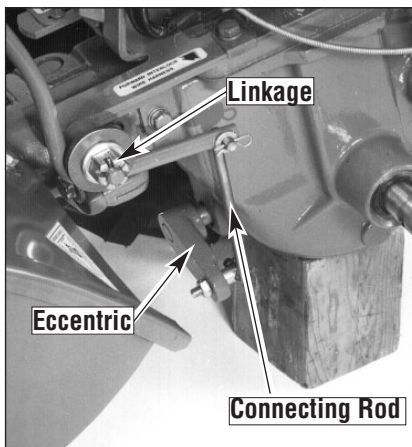

Figure 5-43: Check connecting rod, shifting linkage and eccentric lever.

- Lubricate eccentric lever at rear of power unit transmission (Figure 5-43). If rust is present, use penetrating oil and work eccentric lever back and forth by hand.
- Lubricate linkage to Wheel Speed Lever to eccentric lever (Figure 5-43).
- Clutch inside transmission may be binding. Disconnect linkage from eccentric lever and work eccentric lever by hand. If difficult or impossible to move, it may be due to a damaged keyway on the wheel shaft. Contact Technical Service Department.
- Lubricate washers and castle nut on pivot of lever. If necessary, remove roll pin and back nut off 1/6th turn. Replace roll pin and test the movement.
- Apply grease to zerk fitting (if so equipped) with grease gun until grease appears around washers.

B. Lever shifts into FAST wheel gear, but not into SLOW wheel gear–

- Connecting rod at end of lever might be backwards, or bent in toward transmission housing and hitting it. Other shifting linkage might be bent. Straighten or replace linkage (Figure 5-43).
- Clutch inside transmission may be binding (Problem 2-A).

C. Lever moves freely, but won't shift in or out of gear–

- Eccentric shifting pin inside transmission may be broken (rare) or worn. Disconnect linkage from eccentric lever and try moving eccentric lever by hand (Figure 5-43). If lever moves easily, contact the Technical Service Department.

3 Wheels and Tines Won't Turn:

- Review operation of controls (Sect. 3 & 4).
- Check condition and adjustment of drive belt and reverse disc (Sect. 5).
- Mounting bolt for transmission drive pulley may be loose. (See Figure 5-1). If so, drive belt or reverse disc will turn pulley, but pulley won't turn main drive shaft.
- Worm gears that drive wheel and tiller shafts may be worn.

4 Wheels Turn, But Tines Won't:

- Tines/PTO Clutch Lever must be in ENGAGE position (Sect. 3).
- Tines/PTO Clutch Lever may need adjustment.
- Key for dog clutch on tine attachment main drive shaft may be missing, broken.
- Worm gears that drive the tine shaft may be worn.

Appendix A: Troubleshooting

- Hardware holding tine holders to tine shaft may be missing or broken. To check, remove holders (Sect. 5).

- Key for bronze worm gear on tine attachment main drive shaft may be missing or broken.

5 Tines Turn, But Wheels Won't:

- Check operation of Wheel Speed Lever (Problem 2).
- Hi-Pro key inside wheel clutch may be missing, broken. If so, clutch will not turn wheel shaft.
- FAST and SLOW speed wheel gears may be worn. If only one gear is worn, there will only be one wheel speed.
- Worm gear that drives pinion shaft and pinion gears may be worn.
- FAST and SLOW speed pinion gears may be worn. If only one gear is worn, there will only be one wheel speed.
- Drive "dogs" on sides of wheel clutch may be worn or broken. If only one side of clutch is affected, there will only be one wheel speed.

6 Wheels And Tines Turn On Top Of Ground, But Stop Or Hesitate In Soil:

- Drive belt may be loose (Sect. 5).
- Mounting bolt for transmission drive pulley may be loose (Figure 5-1).

7 Tiller Jumps While Tilling:

- Depth Regulator Lever set too deep for soil conditions. Use a shallower setting.
- Engine throttle speed too fast.
- Tiller wheel speed too fast for soil conditions. Change to LOW belt range or SLOW wheel speed.

8 Depth Regulator Lever Difficult To Move:

- Lubricate spring assembly and depth adjustment bar (Sect. 5).
- Check for bent depth adjustment bar.

9 Wheel And Shaft Move Out To One Side:

- Snap ring on wheel shaft may be dislodged. Raise wheels off ground and check for back and forth play in shaft. If there is play, one or both snap rings is loose.

10 Tiller Pulls To One Side:

- Check tire pressure (Sect. 5).

11 Tine Holder Bolt Breaks Or Loosens:

- Earlier models have tine holder keys. Check that keys are in keyways of tine shaft. Without key in holder, left-side tine bolt will tighten and break; right-side bolt will loosen (Sect. 5).

12 Poor Traction:

- Bar tread tires, tire chains, or wheel weights may be needed.

13 Gear Oil Leak From Power Unit Or Tine Attachment Transmissions:

- See Section 5.

14 Engine Lacks Power:

- *Air cleaner restricted with dirt and/or oil.
- Spark plug wire loose or damaged. Spark plug worn or fouled.
- Engine under excessive work load. Use SLOW wheel speed and LOW belt range.
- *Throttle cable may be loose or misadjusted.
- Verify that engine isn't running with choke partially engaged.
- *Check Carburetor adjustment.
- *Engine overheating. Check oil level and clean cooling fins. Oil may be very dirty. Let hot engine cool before restarting.
- *Dirt or water in fuel or fuel system.
- Engine crankcase low in oil, or overfilled with oil. Check and adjust level.
- *Low engine compression.

15 Engine Difficult To Start:

- Wheels/Tines/PTO Drive Lever not in NEUTRAL position.
- Fuel tank low or empty.
- *Dirt or water in fuel or fuel system.
- *Fuel line is restricted.
- *Choke control not set properly.
- *Spark plug worn or fouled (weak spark).
- *Air cleaner restricted with dirt and/or oil.
- *Throttle cable adjustment.
- Engine throttle lever not free to move through its full operating range.
- Throttle wire and its linkage are binding, or are bent and not free to move.
- Low engine compression.

16 Engine Won't Start:

- See Troubleshooting the *Forward Interlock Safety System* in Section 5.
- Wheels/Tines/PTO Drive Lever not in NEUTRAL position.
- Fuel tank low or empty. Or fuel line restricted or clogged.
- *Choke control improperly set.
- *Water or dirt in fuel, and /or fuel system.
- *Spark plug fouled or worn. Spark plug wire loose or damaged.
- *Carburetor may need adjustment.
- *Air filter clogged with oil or dirt.
- Carburetor float faulty (or float valve leaking)— if so, tap side of bowl lightly with handle of screwdriver (or similar object).
- Stale fuel clogs carburetor, and valves. Drain old fuel and add new fuel.

- *Fuel tank shut-off valve (if so equipped) not in fully Open position.
- On Briggs & Stratton engine, On/Off switch not in ON position.

Electric Start Engines Only:

- Electrical connections loose or shorted to metal frames, brackets or covers (Sect. 5).
- Battery discharged (Sect. 5).
- Electric starter motor faulty.

17 Engine Shuts Off When Wheels/Tines/PTO Drive Lever Is In Forward:

- See *Troubleshooting the Forward Interlock Safety System* in Section 5.
- Short in key switch or key switch wire harness.

- Check starter motor mounting bolts for looseness. Have Authorized Engine Service Dealer inspect the starter motor.

- Check oil level for correct amount.

18 Engine Overheats

- Clean the engine cooling fins, shroud and covers (Sect. 5).
- Check for broken flywheel fins (under engine shroud). See Authorized Engine Dealer.

19 Engine Runs Erratically:

- Water or dirt in gasoline or carburetor.
- Carburetor may need adjustment. See Engine Owner's Manual.
- *Spark plug fouled or dirty. Spark plug wire loose or damaged.
- *Loose or cracked carburetor.
- Governor linkage not adjusted properly or binding. See Authorized Engine Service Dealer. Don't attempt to repair by yourself.
- Check pan gasket, engine seals and drain plugs for leaks. See your Authorized Engine Service Dealer.

20 Engine Runs Well, But Labors Under Tiller Load

- *Check governor linkage for freedom of movement.
- Check throttle setting and carburetor adjustment. See Engine Owner's Manual.
- Tilling depth is possibly too deep. To correct, lower the depth regulator lever.
- Possible worn tiller worm gear or loose drive shaft.

21 Key Switch Will Not Start The Engine

- Check battery terminals for corrosion (Sect. 5).
- Discharged battery (Sect. 5).
- Defective solenoid.

Troy-Bilt® PTO Log Splitter **290-258-081**

The Troy-Bilt® PTO Log Splitter provides you with a convenient and easy means of splitting about a half a cord of wood per hour when working alone. When connected to the PTO Power Unit, the tiller's engine runs the splitter's hydraulic pump, providing you with 13 tons of steady, unhurried and predictable splitting force.

As an added benefit, the power-driven mobility provided by the PTO Power Unit allows you to move the splitter to and from your wood pile, over to a neighbor's place, or along the woodpile to a fresh supply of logs.

Features include a 15 second splitting cycle; can handle log sizes up to 26" long; a two-stage hydraulic pump that automatically shifts into low gear to provide four-times greater pressure when needed; slim-cut wedge design for splitting green, stringy wood; and an auto-control valve for automatic return stroke.

Dozer/Snow Blade Attachment **290-259-081**

In the winter, moves up to one foot of light snow (or 6"-to-8" of heavy snow); at other times use it to move or spread sand, gravel, loose dirt, grain, sawdust, etc. Attaches easily to the front of the Wrap-Around Bumper Guard. Set the blade to several angles. Weighs 41-lbs.; measures 15" x 32".

Row Marker Attachment **290-257-081**

Do you like very straight, even, neat rows in your garden? If so, the Row Marker is a must attachment. Hooks quickly to the Hiller/Furrower attachment— eliminates the need for string, stakes, measuring tape, etc. You'll like the straight rows it helps you make if you lay out furrows, dig compost trenches, or make raised beds. The Row Marker extends from 28"-to-49 $\frac{3}{4}$ ", letting you vary the width between rows to suit the crop you're planting.

V-Sweep Cultivator **290-260-081**

The V-Sweep Cultivator is a specialized tool designed for between-row crop cultivation. Instead of stirring the soil, it slices through just below the surface to eliminate practically any weeds in its path.

The Sweep mounts easily to the optional Tow Hitch Attachment at the rear of the PTO Power Unit. The blade is made of high carbon, heat treated steel and measures 2" wide (overall wing span is 20").

The unique way the Sweep works, skimming along just underneath the soil's surface without turning the soil over, makes this the ideal tool for use in dry, dusty conditions where it is important to keep soil disturbance to a minimum. And, because of its 20" wide cutting path, it does an effective cultivation job at a fast speed.

The Sweep's natural shallow cultivation helps to prevent weed seeds from being brought to the soil's surface. This shallow cultivation feature also means there's less chance of damaging the roots of your vegetables. For deeper or more shallow cultivating, the blade depth can be changed with a simple adjustment..

Wheel Weights **290-266-081**

Help increase traction by putting extra weight directly on the wheels. They reduce bucking and jumping when deep-tilling in heavy soil. They're shipped empty— fill them with material like concrete, sand, gravel, etc. They bolt directly to the tiller wheels.

Wrap-Around Bumper Guard **290-255-081**

Order this Bumper Guard by itself or receive it as one of the components if you order the combination Dozer/ Snow Blade attachment. Protects the engine from damage by wrapping around and protecting many of the engine components. 1" diameter, high-strength steel tubing.

Hiller/Furrower Attachment **290-250-081**

The most popular attachment because it does so many jobs. Mounts to the rear of the depth regulator bracket. Furrower blade easily makes plant rows, trenches, ditches to 8" deep. When hiller wings are attached to furrower blade, attachment makes hilled rows and raised bed gardens. Converts from a furrower to a hiller and back again, in seconds, without tools.

TROY-BILT TILLER LIFETIME LIMITED WARRANTY

WHAT PRODUCT IS COVERED All Troy-Bilt branded rear tine walk-behind tillers with gear drive transmissions. This warranty begins on the date of purchase and is warranted by Troy-Bilt LLC for the life of the tiller, to the original purchaser only.

WHAT IS COVERED BY THIS WARRANTY Troy-Bilt LLC will, at its option, repair or replace any part found to be defective in material or workmanship without charge for parts and labor.

This limited lifetime warranty also applies to non-powered attachments and accessories. Powered attachments and accessories are warranted separately by their manufacturers. Refer to the applicable manufacturer's warranty on these items for terms and conditions.

WHAT IS NOT COVERED BY THIS WARRANTY This warranty does not apply to parts that have been damaged by accident, alteration, misuse, abuse, neglect, improper maintenance, vandalism, theft, fire, water, or damage because of peril or other natural disaster.

The following items are not covered after the first year of this residential use limited warranty: belts, batteries, bushings, seals, tines, tires, wheels, paint, appearance items, and similar items that are normally replaced through periodic maintenance.

Charges for pick-up, delivery, and service calls are not covered by this warranty.

Service completed by someone other than an authorized service dealer is not covered by this warranty.

Parts that are not genuine Troy-Bilt LLC service parts are not covered by this warranty.

The engine is warranted separately by the engine manufacturer. Refer to the engine manufacturer's warranty for terms and conditions.

LIMITED COMMERCIAL USE WARRANTY If used for commercial, institutional, industrial, rental, or demonstrator purposes, the warranty on the tiller is limited in duration to 90 days from the date of purchase.

This warranty does not apply to parts that have been damaged by accident, alteration, misuse, abuse, neglect, improper maintenance, vandalism, theft, fire, water, or damage because of peril or other natural disaster.

HOW TO OBTAIN SERVICE Warranty service is available, **with proof of purchase**, through your local authorized service dealer. To locate a dealer in your area, consult your Yellow Pages, or contact Troy-Bilt LLC at P.O. Box 361131, Cleveland, Ohio 44136-0019, 1-866-840-6483, or log on to our Web site at www.troybilt.com.

The provisions set forth in this warranty provide the sole and exclusive remedy arising from the sale. Troy-Bilt LLC shall not be liable for any incidental or consequential damage or expense of any kind, including but not limited to cost of equipment rental, loss of profits, or costs of hiring services to perform tasks normally performed by the equipment.

Any implied warranties, including any implied warranty of merchantability or fitness for a particular purpose, shall be limited in duration to the period of ownership by the original purchaser (and a maximum of 90 days from the date of sale if the tiller is purchased for commercial or other non-residential use).

Some states do not allow the exclusion or limitation of incidental or consequential damages, or limitations on how long an implied warranty lasts, so the above exclusions or limitations may not apply to you.

This limited warranty gives you specific legal rights, and you may also have other rights which vary from state to state.

For customer assistance, contact your nearest authorized dealer, or contact us at:

TROY-BILT LLC, P.O. Box 361131, Cleveland, Ohio 44136-0019, 1-866-840-6483

Free Manuals Download Website

<http://myh66.com>

<http://usermanuals.us>

<http://www.somanuals.com>

<http://www.4manuals.cc>

<http://www.manual-lib.com>

<http://www.404manual.com>

<http://www.luxmanual.com>

<http://aubethermostatmanual.com>

Golf course search by state

<http://golfingnear.com>

Email search by domain

<http://emailbydomain.com>

Auto manuals search

<http://auto.somanuals.com>

TV manuals search

<http://tv.somanuals.com>