

## INSTALLATION MANUAL FOR T-23DT FREEZER / REFRIGERATOR (SWING DOOR)



T-23DT

### TABLE OF CONTENTS

#### ► Safety Information

Safety Precautions	1
Proper Disposal	2
Connecting Electricity	3
Adapter Plugs	3

#### ► Installation / Operation Instructions

Ownership	4
Required Tools	4
Uncrating	4
Leveling Cabinet	5
Installation of Castors or Optional Legs	6
Wire Gauge Chart	7
Sealing Cabinet to Floor & Electrical Inst.	8
Start-up	9
Shelving Install/Operation & Light Switches	11
Temperature Control Sequence of Operation	11-14

#### ► Maintenance, Care & Cleaning

Cleaning Condenser Coil	15-16
Stainless Steel Equipment Care & Cleaning	17-18
Light Bulb Replacement	18
Warranty (U.S.A. & CANADA ONLY!)	19

### CONGRATULATIONS!

*You have just purchased the finest commercial freezer / refrigerator available. You can expect many years of trouble-free operation.*

# T-23DT FREEZER / REFRIGERATOR SWING DOOR

# NOTICE TO CUSTOMER:



**Loss Or Spoilage Of Products  
In Your Refrigerator/Freezer  
Is NOT Covered By Warranty.  
In Addition To Following  
Recommended Installation  
Procedures You Must Run  
The Refrigerator/Freezer  
24 Hours Prior To Usage.**

True Manufacturing Company, Inc.

SAFETY INFORMATION

# **How to Maintain Your *TRUE* Freezer / Refrigerator to Receive the Most Efficient and Successful Operation**

*You have selected one of the finest commercial refrigeration units made. It is manufactured under strict quality controls with only the best quality materials available. Your TRUE cooler when properly maintained will give you many years of trouble-free service.*

## **WARNING!**

***Use this appliance for its intended purpose as described in this Owner Manual.***

***This cabinet contains fluorinated greenhouse gas covered by the Kyoto Protocol (please refer to cabinet's inner label for type and volume, GWP of 134a= 1,300. R404a= 3,800).***

## **SAFETY PRECAUTIONS**

*When using electrical appliances, basic safety precautions should be followed, including the following:*

- This refrigerator must be properly installed and located in accordance with the Installation Instructions before it is used.
- Do not allow children to climb, stand or hang on the shelves in the refrigerator. They could damage the refrigerator and seriously injure themselves.
- Do not touch the cold surfaces in the freezer compartment when hands are damp or wet. Skin may stick to these extremely cold surfaces.
- Do not store or use gasoline or other flammable vapors and liquids in the vicinity of this or any other appliance.
- Keep fingers out of the "pinch point" areas; clearances between the doors and between the doors and cabinet are necessarily small; be careful closing doors when children are in the area.

### **NOTE**

*We strongly recommend that any servicing be performed by a qualified individual.*

- Unplug the refrigerator before cleaning and making repairs.
- Setting temperature controls to the off position does not remove power to the light circuit, perimeter heaters, or evaporator fans.

SAFETY INFORMATION

# **DANGER!**

## **RISK OF CHILD ENTRAPMENT**

### **PROPER DISPOSAL OF THE FREEZER / REFRIGERATOR**

---

Child entrapment and suffocation are not problems of the past. Junked or abandoned refrigerators are still dangerous... even if they will sit for “just a few days.” If you are getting rid of your old refrigerator, please follow the instructions below to help prevent accidents.

**Before You Throw Away Your Old Refrigerator or Freezer:**

- Take off the doors.
- Leave the shelves in place so that children may not easily climb inside.

**Refrigerant Disposal**

Your old refrigerator may have a cooling system that uses “Ozone Depleting ” chemicals. If you are throwing away your old refrigerator, make sure the refrigerant is removed for proper disposal by a qualified service technician. If you intentionally release any refrigerants you can be subject to fines and imprisonment under provisions of the environmental regulations.

### **USE OF EXTENSION CORDS**

---

*NEVER USE AN EXTENSION CORD! TRUE will not warranty any refrigerator that has been connected to an extension cord.*

SAFETY INFORMATION

# WARNING!

## HOW TO CONNECT ELECTRICITY

*Do not, under any circumstances, cut or remove the ground prong from the power cord. For personal safety, this appliance must be properly grounded.*

The power cord of this appliance is equipped with a grounding plug which mates with a standard grounding wall outlet to minimize the possibility of electric shock hazard from this appliance.

Have the wall outlet and circuit checked by a qualified electrician to make sure the outlet is properly grounded.

If the outlet is a standard 2-prong outlet, it is your personal responsibility and obligation to have it replaced with the properly grounded wall outlet.

The refrigerator should always be plugged into its own individual electrical circuit, which has a voltage rating that matches the rating plate.

This provides the best performance and also prevents overloading building wiring circuits which could cause a fire hazard from overheated wires.

Never unplug your refrigerator by pulling on the power cord. Always grip plug firmly and pull straight out from the outlet.

Repair or replace immediately all power cords that have become frayed or otherwise damaged. Do not use a cord that shows cracks or abrasion damage along its length or at either end.

When removing the refrigerator away from the wall, be careful not to roll over or damage the power cord.

## USE OF ADAPTER PLUGS

*NEVER USE AN ADAPTER PLUG! Because of potential safety hazards under certain conditions, we strongly recommend against the use of an adapter plug.*

**(North America Use Only!)**

NEMA plugs

TRUE uses these types of plugs. If you do not have the right outlet have a certified electrician install the correct power source.



## INSTALLATION / OPERATION INSTRUCTIONS

**INSTALLATION / OPERATION INSTRUCTIONS**  
**OWNERSHIP**

To ensure that your unit works properly from the first day, it must be installed properly. We highly recommend a trained refrigeration mechanic and electrician install your **TRUE** equipment. The cost of a professional installation is money well spent.

Before you start to install your **TRUE** unit, carefully inspect it for freight damage. If damage is discovered, immediately file a claim with the delivery freight carrier.

**TRUE is not responsible for damage incurred during shipment.**

**REQUIRED TOOLS**

- Adjustable Wrench
- Phillips Head Screwdriver
- Level

**UNCRATING**

The following procedure is recommended for uncrating the unit:

- A.** Remove the outer packaging, (cardboard and bubbles or styrofoam corners and clear plastic). Inspect for concealed damage. Again, immediately file a claim with the freight carrier if there is damage.
- B.** Move your unit as close to the final location as possible before removing the wooden skid.

- C.** Remove door bracket on swinging glass door models (see image 1-2). Do not throw the bracket or blocks away. For future cabinet movement the bracket will need to be installed so the glass door does not receive any damage. (See image for bracket removal)

**NOTE**

*Keys for coolers with door locks are located in warranty packets.*



## INSTALLATION / OPERATION INSTRUCTIONS

### LOCATING

- A.** Remove louver from the front of cabinet (see page 17 for louver grill removal / reinstallation) and backguard (if applicable) from rear of cabinet.
- B.** Skid bolts are located in each of 4 corners inside cabinet bottom. (See photo A).
- C.** Remove skid bolts. (See photo B).
- D.** Cut straps if applicable. (See photo C).
- E.** Carefully lift cabinet off of skid.

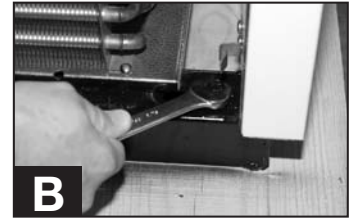
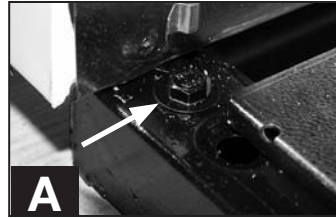

Removing skid from bottom of cabinet.

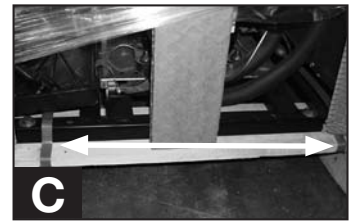

### LEVELING

- A.** Set unit in its final location. Be sure there is adequate ventilation in your room. Under extreme heat conditions, (100°F+, 38°C+), you may want to install an exhaust fan.

#### WARNING

Warranty is void if ventilation is insufficient.

- B.** Proper leveling of your TRUE cooler is critical to operating success (for non-mobile models). Effective condensate removal and door operation will be effected by leveling.
- C.** The cooler should be leveled front to back and side to side with a level.
- D.** Ensure that the drain hose or hoses are positioned in the pan.
- E.** Free plug and cord from inside the lower rear of the cooler (do not plug in).
- F.** The unit should be placed close enough to the electrical supply so that extension cords are never used.

#### WARNING

**Cabinet warranties are void if OEM power cord is tampered with. TRUE will not warranty any units that are connected to an extension cord.**

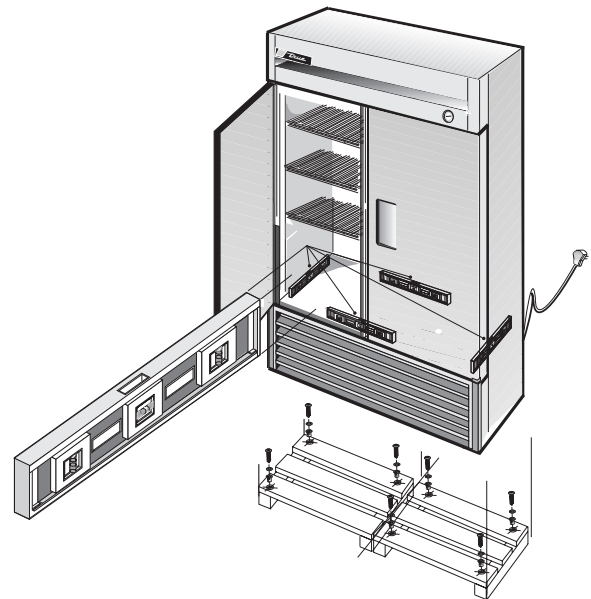

### REMOTE UNITS (This section applies to remotes only!)

- Remote cabinets must be ordered as remote. We do not recommend converting from a standard self contained to remote system.
- All remote cabinets must be hard wired.
- No castors available.
- All remote cabinets come standard using 404A refrigerant.
- All remote units come standard with expansion valve, liquid line solenoid, heated condensate pan, and defrost timer when applicable.
- Contact TRUE Technical Service for BTU requirements.
- No wiring necessary between cabinet and condensing unit.
- All remote condensing units purchased from TRUE are 208/230 volts single phase.

**If you have any questions regarding this section, please call TRUE at 1-(800)-325-6152.**

INSTALLATION / OPERATION INSTRUCTIONS

**INSTALLATION OF CASTORS OR OPTIONAL LEGS**

Important Safeguard for installation of leg/castor (Images 1-5 demonstrate procedure)

**Securing Castors and Legs**

To obtain maximum strength and stability of the unit, it is important that you make sure each castor is secure. Optional legs are hand-tightened securely against the lower rail assembly see image 4-5. The bearing race on the castor or the top edge of the leg must make firm contact with the rail.

**Unit leveling**

Four leveling shims have been provided for leveling castored units positioned on uneven floors. Shims must be positioned between rail end and bearing race.

**A.** Turn the bearing race counter-clockwise until the cabinet is level. Level front to back and side to side. (diagonally)

**B.** Install the desired number of shims, making sure the slot of the shim is in contact with the threaded stem of the castor. (See image 2)

**C.** If more than one shim is used, turn the slot at a 90° angle so they are not in line.

**D.** Turn the bearing race clockwise to tighten and secure the castor by tightening the anchoring bolt with a 3/4 inch open-end wrench or the tool provided. (See image 3)

**CAUTION**

To avoid damage to lower rail assembly, slowly raise unit to upright position.

**NOTE**

Open holes located on the cross members of the frame rail should be plugged before unit is in use.



**1** Thread castor into the underside of cabinet frame rail.



**2** For leveling, insert the shim between the castor and frame rail.



**3** Use the tool provided to tighten the castor into place.



**4** Thread leg into cabinet bottom frame rail.

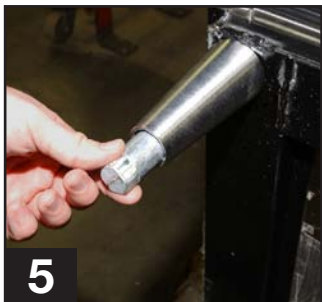

**5** The end of the leg is adjustable to easy leveling.

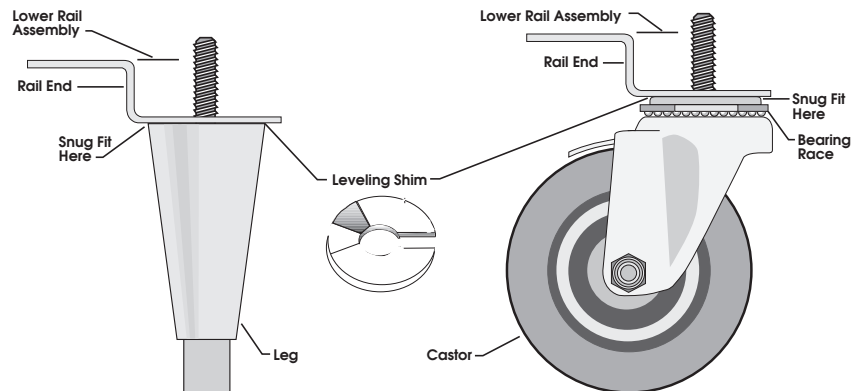



INSTALLATION / OPERATION INSTRUCTIONS

**CONDUCTORS AND CIRCUITS**

**Wire Gauge for 2% Voltage Drop in Supply Circuits**

115 Volt Amps	Distance In Feet To Center of Load											
	20	30	40	50	60	70	80	90	100	120	140	160
2	14	14	14	14	14	14	14	14	14	14	14	14
3	14	14	14	14	14	14	14	14	14	14	14	14
4	14	14	14	14	14	14	14	14	14	12	12	12
5	14	14	14	14	14	14	14	12	12	12	10	10
6	14	14	14	14	14	14	12	12	12	10	10	10
7	14	14	14	14	14	12	12	12	10	10	10	8
8	14	14	14	14	12	12	12	10	10	10	8	8
9	14	14	14	12	12	12	10	10	10	8	8	8
10	14	14	14	12	12	10	10	10	10	8	8	8
12	14	14	12	12	10	10	10	8	8	8	8	6
14	14	14	12	10	10	10	8	8	8	6	6	6
16	14	12	12	10	10	8	8	8	8	6	6	6
18	14	12	10	10	8	8	8	8	8	8	8	5
20	14	12	10	10	8	8	8	6	6	6	5	5
25	12	10	10	8	8	6	6	6	6	5	4	4
30	12	10	8	8	6	6	6	6	5	4	4	3
35	10	10	8	6	6	6	5	5	4	4	3	2
40	10	8	8	6	6	5	5	4	4	3	2	2
45	10	8	6	6	6	5	4	4	3	3	2	1
50	10	8	6	6	5	4	4	3	3	2	1	1

**Wire Gauge for 2% Voltage Drop in Supply Circuits**

230 Volts Amps	Distance In Feet To Center of Load											
	20	30	40	50	60	70	80	90	100	120	140	160
5	14	14	14	14	14	14	14	14	14	14	14	14
6	14	14	14	14	14	14	14	14	14	14	14	14
7	14	14	14	14	14	14	14	14	14	14	12	12
8	14	14	14	14	14	14	14	14	14	12	12	12
9	14	14	14	14	14	14	14	14	12	12	12	10
10	14	14	14	14	14	14	14	12	12	12	10	10
12	14	14	14	14	14	14	12	12	12	10	10	10
14	14	14	14	14	14	12	12	12	10	10	10	8
16	14	14	14	14	12	12	12	10	10	10	8	8
18	14	14	14	12	12	12	10	10	10	8	8	8
20	14	14	14	12	10	10	10	10	10	8	8	8
25	14	14	12	12	10	10	10	10	8	8	6	6
30	14	12	12	10	10	10	8	8	8	6	6	6
35	14	12	10	10	10	8	8	8	8	6	6	5
40	14	12	10	10	8	8	8	6	6	6	5	5
50	12	10	10	8	6	6	6	6	6	5	4	4
60	12	10	8	6	6	6	6	6	5	4	4	3
70	10	10	8	6	6	6	5	5	4	4	2	2
80	10	8	8	6	6	5	5	4	4	3	2	2
90	10	8	6	6	5	5	4	4	3	3	1	1
100	10	8	6	6	5	4	4	3	3	2	1	1

## INSTALLATION / OPERATION INSTRUCTIONS

**ELECTRICAL INSTRUCTIONS**

- A.** Before your new unit is connected to a power supply, check the incoming voltage with a voltmeter. If anything less than 100% of the rated voltage for operation is noted, correct immediately.
- B.** All units are equipped with a service cord, and must be powered at proper operating voltage at all times. Refer to cabinet data plate for this voltage.

**TRUE** requires that a sole use circuit be dedicated for the unit. Failure to do so voids warranty.

**WARNING**

Compressor warranties are void if compressor burns out due to low voltage.

**WARNING**

Power supply cord ground should not be removed!

**NOTE**

To reference wiring diagram - Remove front louvered grill, wiring diagram is positioned on the inside cabinet wall.

**SEALING CABINET TO FLOOR****Step 1 - Position Cabinet**

Allow one inch between the wall and rear of the refrigerator to assure proper ventilation. For freezers 3 inches between the wall and rear of the cabinet will assure proper ventilation.

**Step 2 - Level Cabinet**

Cabinet should be level, side to side and front to back. Place a carpenter's level in the interior floor in four places:

- A.** Position level in the inside floor of the unit near the doors. (Level should be parallel to cabinet front). Level cabinet.
- B.** Position level at the inside rear of cabinet. (Again level should be placed parallel to cabinet back).
- C.** Perform similar procedures to steps a & b by placing the level on inside floor (left and right sides - parallel to the depth of the cooler). Level cabinet.

**Step 3**

Draw an outline on the base on the floor.

**Step 4**

Raise and block the front side of the cabinet.

**Step 5**

Apply a bead of "NSF Approved Sealant", (see list below), To floor on half inch inside the outline drawn. The bead must be heavy enough to seal the entire cabinet surface when it is down on the sealant.

**Step 6**

Raise and block the rear of the cabinet

**Step 7**

Apply sealant on floor as outline in Step 5. on other three sides.

**Step 8**

Examine to see that cabinet is sealed to floor around entire perimeter.

**NOTE**

Asphalt floors are very susceptible to chemical attack. A layer of tape on the floor prior to applying the sealant will protect the floor.

**NSF Approved Sealants:**

1. Minnesota Mining #ECU800 Caulk
2. Minnesota Mining #ECU2185 Caulk
3. Minnesota Mining #ECU1055 Bead
4. Minnesota Mining #ECU1202 Bead
5. Armstrong Cork - Rubber Caulk
6. Products Research Co. #5000 Rubber Caulk
7. G.E. Silicone Sealer
8. Dow Corning Silicone Sealer

INSTALLATION / OPERATION INSTRUCTIONS

**STARTUP**

- A.** The compressor is ready to operate. Plug in the cooler.
- B.** Factory approximate refrigerator temperature of 35°F and approximate freezer temperature of -10°F. Allow unit to function several hours, completely cooling cabinet before changing the control setting.
- C.** Excessive tampering with the control could lead to service difficulties. Should it ever become necessary to replace temperature control, be sure it is ordered from your TRUE dealer or recommended service agent.
- D.** Good air flow in your TRUE unit is critical. Be careful to load product so that it neither presses against the back wall, nor comes within four inches of the evaporator housing. Refrigerated air off the coil must circulate down the back wall.

**NOTE**

*If the cooler is disconnected or shut off, wait five minutes before starting again.*

**RECOMMENDATION**

*Before loading product we recommend you run your TRUE unit empty for two to three days. This allows you to be sure electrical wiring and installation are correct and no shipping damage has occurred. Remember, our factory warranty does not cover product loss!*

**REPLACEMENT PARTS**

*TRUE maintains a record of the cabinet serial number for your cooler. If at any time during the life of your cooler, a part is needed, you may obtain this part by furnishing the model number and serial number to the company from whom you purchased the cooler. Call Toll-Free: (800)-424-TRUE (Direct to Parts Department). (800)-325-6152 (U.S.A. & Canada only) or call: (636)-240-2400.*

INSTALLATION / OPERATION INSTRUCTIONS

**SHELVING INSTALLATION / OPERATION & LIGHT SWITCH LOCATION**

**WARNING**

Do not use pliers or any crimping tools when installing shelf clips. Altering shelf clips in any way can lead to shelving instability.

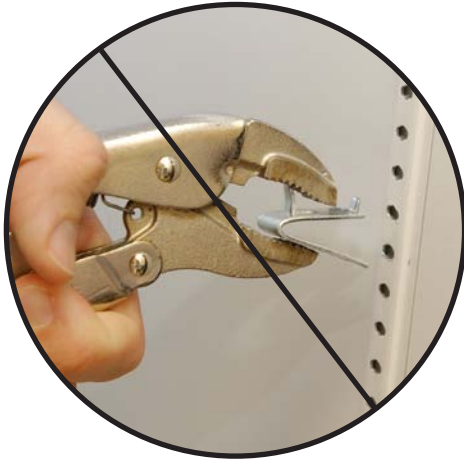

For Proper Shelf Clip Installation Please Read The Following Instructions.

**Step 1**

Shelf clips are to be installed into the shelf standards next to the labels on the interior cabinet wall. This label can be seen in images 1-4. Install the top tab of the shelf clip into the proper hole. Push up on the bottom of the clip. (See image 1).

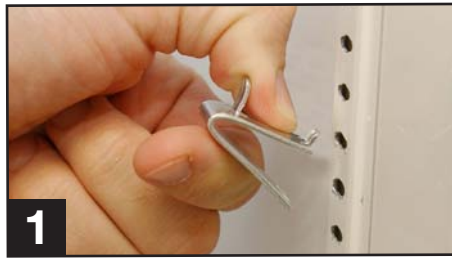

1 (Installing top tab of shelf clip)

**Step 2**

Bottom tab of the shelf clip will fit tightly. You may need to squeeze or twist the bottom of the shelf clip to install. (See image 2 & 3).

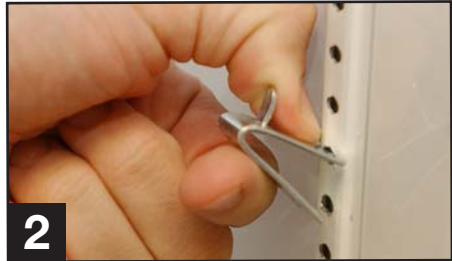

2 (Installing bottom of the shelf clip)



3 You may need to squeeze or twist the bottom of the shelf clip to install)



4 (Shelf clip installation complete)

**Step 3**

After installation, the shelf clip will fit snug into the shelf standard. The shelf clip should not be loose or able to wiggle out of the shelf standard.

**Shelf Installation Tips**

1. Install all the shelf clips before installing the shelves.
2. Start at the bottom in terms of shelf installation and work your way up.
3. Always lay the back of each shelf down on the rear clips before the front.

**SHELF & ORGANIZER INSTALLATION:**

**Step 1**

- A. Hook shelf clips onto shelf standards. (see illustration).
- B. Position all four shelf clips equal in distance from the floor for flat shelves.

**WIRE SHELVES**

Wire shelves are oriented so that cross support bars are facing down.

**NOTE**

T-Series models include an airflow guard on the rear of shelves to maintain an air space at the rear of the cabinet. (see illustration).

**Step 2**

Place shelves on shelf clips making sure all corners are seated properly.

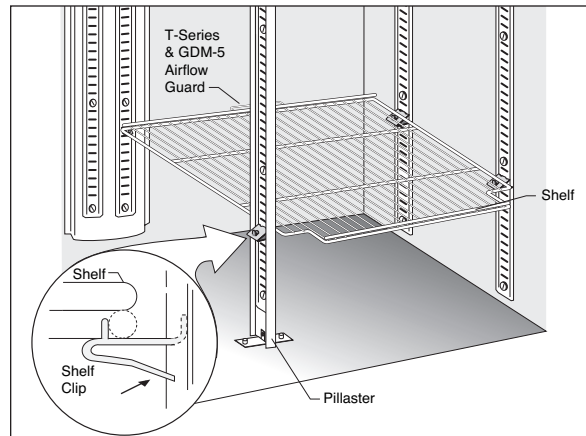

**LIGHT SWITCH LOCATION:**

Light switch location depends upon the T-Series model. Most T-Series models will have the light switch located inside the unit on the right side of the ceiling. Some models have the switch located on the right side of the evaporator housing along the interior ceiling.

## **DANFOSS TEMPERATURE CONTROL (FREEZER SEQUENCE OF OPERATION)**

- 1. Cabinet is plugged in.**
  - a. Display will illuminate showing “deF”.
  - b. Cabinet will start in a Defrost Cycle.
- 2. During the initial Defrost Cycle, the evaporator fan(s) and the compressor will remain off for a minimum of 4 minutes.**
  - a. After the Defrost Cycle there will be a 2 minute delay.
  - b. After the 2 minute delay the compressor will start.
  - c. The evaporator fans will remain off for an additional 3 minutes.
  - d. The display will continue to show “deF” for an additional 30 minutes.
- 3. The electronic control will cycle the compressor and the evaporator fan(s) on and off determined by the Set-Point and Differential temperatures (Set-Point is adjustable).**
  - a. The Set-Point is the preprogrammed temperature which shuts off the compressor and evaporator fan(s).
  - b. The Differential is the preprogrammed temperature that is added to the Set-Point temperature that will start the compressor and evaporator fan(s).
  - c. The Danfoss control is designed to read and display a cabinet temperature. This cabinet temperature may reflect the refrigeration cycle of the Set-Point and it’s Differential.

**Example: If the Set-Point is -6°F/1°C and the Differential is 6°F/4°C**

$$\text{(Set-Point) } -6^{\circ}\text{F} + 6 \text{ (Differential)} = 0^{\circ}\text{F}$$

**Or**

$$\text{(Set-Point) } -21.4^{\circ}\text{C} + 3.3 \text{ (Differential)} = -18.1^{\circ}\text{C}$$

**The compressor will cycle off -6°F/-21.4°C and back on at 0°F/-18.1°C**

- 4. The electronic control is preprogrammed to initiate defrost every 4 hours of compressor run time (non-adjustable).**
  - a. At this time the evaporator fans and the compressor will turn off.
  - b. Once a preprogrammed temperature of the evaporator coil is reached, the Defrost Cycle will terminate and the 2 minute delay will occur.
  - c. After the 2 minute delay the compressor will restart.
  - d. The evaporator fans will remain off for an additional 3 minutes.
  - e. The display will continue to show “deF” for an additional 30 minutes.

**TRUE Manufacturing recommends that only the Set-Point may be adjusted due to certain conditions.**

## **DANFOSS TEMPERATURE CONTROL (REFRIGERATOR SEQUENCE OF OPERATION)**

1. **Cabinet is plugged in.**
  - a. Display will illuminate showing “deF”.
  - b. Cabinet will start in a Defrost Cycle.
2. **During the initial Defrost Cycle, the evaporator fan(s) will run but the compressor will remain off for a minimum of 4 minutes.**
  - a. After the Defrost Cycle there will be a 2 minute delay and the evaporator fan(s) will stop.
  - b. After the 2 minute delay the compressor will start, and evaporator fan(s) will delay 60 seconds.
  - c. The display will continue to show “deF” for an additional 30 minutes.
3. **The electronic control will cycle the compressor and the evaporator fan(s) on and off determined by the Set-Point and Differential temperatures (Set-Point is adjustable).**
  - a. The Set-Point is the preprogrammed temperature which shuts off the compressor and evaporator fan(s).
  - b. The Differential is the preprogrammed temperature that is added to the Set-Point temperature that will start the compressor and evaporator fan(s).
  - c. The Danfoss control is designed to read and display a cabinet temperature. This cabinet temperature may reflect the refrigeration cycle of the Set-Point and it’s Differential.

**Example: If the Set-Point is 34°F/1.1°C and the Differential is 6°F/3.3°C**

$$\text{(Set-Point) } 34^{\circ}\text{F} + 6 \text{ (Differential)} = 40^{\circ}\text{F}$$

**Or**

$$\text{(Set-Point) } 1.1^{\circ}\text{C} + 3.3 \text{ (Differential)} = 4.4^{\circ}\text{C}$$

**The compressor will cycle off 34°F/1.1°C and back on at 40°F/4.4°C**

4. **The electronic control is preprogrammed to initiate defrost every 4 hours of compressor run time (non-adjustable).**
  - a. At this time the evaporator fans will continue to run but the compressor will turn off.
  - b. Once a preprogrammed temperature of the evaporator coil is reached, the Defrost Cycle will terminate and the 2 minute delay will start stopping the evaporator fan(s).
  - c. After the 2 minute delay the compressor will restart, and evaporator fan(s) will delay 60 seconds.
  - d. The display will continue to show “deF” for an additional 30 minutes.

**TRUE Manufacturing recommends that only the Set-Point may be adjusted due to certain conditions.**

## **Danfoss Electronic Control (Power On)**



*Press both buttons to power on temp control*

### **TURNING ON POWER**

- A.** Press both buttons to power on the temperature control.

## **Danfoss Electronic Control (Power Off)**



*Press both buttons and hold for 6 seconds to power off temp control*

### **TURNING OFF POWER**

- A.** Press both buttons and hold for 6 seconds to power off the temperature control.

## Danfoss Electronic Control (Defrost)



Press bottom button and hold for 6 seconds to start defrost

### DEFROST

- A. Press bottom button and hold for 6 seconds to defrost.

## Danfoss Electronic Control (Cut out Temperature)



Press and release top or bottom button for 2 seconds to display cut out temperature

### CUT OUT TEMPERATURE

- A. Press and release top or bottom button for 2 seconds to display cut out temperature.

### CHANGE CUT OUT TEMPERATURE

- A. Raise or lower the set point use the top or bottom button to go up or down. Release the button and temperature will go back.

**NOTE** - Cut in temperature is the set point plus the fix differential.



MAINTENANCE, CARE & CLEANING

**MAINTENANCE, CARE & CLEANING**

**CLEANING THE CONDENSER COIL**

When using electrical appliances, basic safety precautions should be followed, including the following:

**REQUIRED TOOLS:**

- Phillips Screwdriver
- Stiff Bristle Brush
- Adjustable Wrench
- Air Tank or CO<sub>2</sub> Tank • Vacuum Cleaner

**Step 1**

Disconnect power to unit.

**Step 2**

SLIDE DOOR MODELS: (See Image 1)

Take off lower grill assembly by removing two (2) screws in lower corners. (older models may have snap lock tabs instead of screws).

Loosen screws holding the top pivot pins. Swing grill up and remove frame hooks from pivot pins at top of louver.

SWING DOOR MODELS: (See Image 2)

Take off lower grill assembly by opening the door and removing screws from the top of the louver grill. Some models have a door light switch. Please use caution when removing the grill on these models. Do not pinch wires. For reinstall, reattach the grill to the magnets on front of the cabinet and reinstall the screws on top of the grill.

**Step 3**

Remove bolts anchoring compressor assembly to frame rails and carefully slide out. (tube connections are flexible)

**Step 4**

Clean off accumulated dirt from the condenser coil and the fan with a stiff bristle brush.

**Step 5**

Lift cardboard cover above fan at plastic plugs and carefully clean condenser coil and fan blades.

**Step 6**

**INDOOR LOCATION:**

After brushing condenser coil vacuum dirt from coil, and interior floor.

**OUTDOOR LOCATION:**

(GDM-33, GDM-47, and GDM-49 only) After brushing condenser coil blow CO<sub>2</sub> through condenser from fin side to fan. (See Image 4.)

**Step 7**

Replace cardboard cover. Carefully slide compressor assembly back into position and replace bolts.

**Step 8**

Reinstall louver assembly onto unit with appropriate fastener and clips. Tighten all screws.

**Step 9**

Connect unit to power and check to see if compressor is running.



1 Slide Door Models

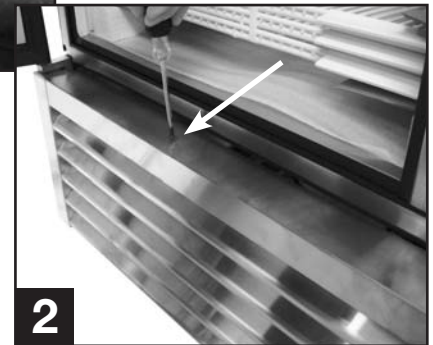

2 Swing Door Models

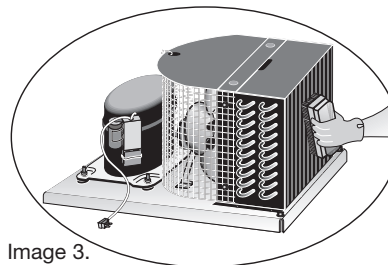

Image 3.

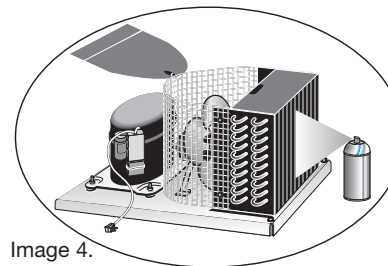
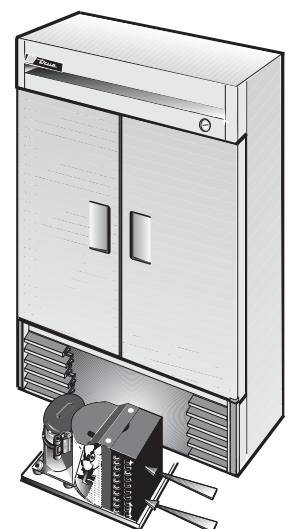

Image 4.



## IMPORTANT WARRANTY INFORMATION

**Condensers accumulate dirt and require cleaning every 30 days. Dirty condensers result in compressor failure, product loss, and lost sales... which are not covered by warranty.**

**If you keep the Condenser clean you will minimize your service expense and lower your electrical costs. The Condenser requires scheduled cleaning every thirty days or as needed.**

**Air is pulled through the Condenser continuously, along with dust, lint, grease, etc.**

**A dirty Condenser can result in NON-WARRANTEED part & Compressor Failures, Product Loss, and Lost Sales.**

**Proper cleaning involves removing dust from the Condenser. By using a soft brush, or vacuuming the Condenser with a shop vac, or using CO2, nitrogen, or pressurized air.**

**If you cannot remove the dirt adequately, please call your refrigeration service company.**

**On most of the units the condenser is accessible in the rear of the unit. You must remove the cabinet grill to expose the Condenser.**

**The Condenser looks like a group of vertical fins. You need to be able to see through the condenser for the unit to function at maximum capacity. Do not place filter material in front of condensing coil. This material blocks air-flow to the coil similar to having a dirty coil.**

**THE CLEANING OF THE CONDENSER IS NOT COVERED BY THE WARRANTY!**

### HOW TO CLEAN THE CONDENSER:

1. Disconnect the electrical power to the unit.
2. Remove the louvered grill.
3. Vacuum or brush the dirt, lint, or debris from the finned condenser coil.
4. If you have a significant dirt build up you can blow out the condenser with compressed air. **(CAUTION MUST BE USED to avoid eye injury. Eye protection is recommended.)**
5. When finished be sure to replace the louvered grill. The grill protects the condenser.
6. Reconnect the electrical power to the unit.

**If you have any questions, please call TRUE Manufacturing at 636-240-2400 or 800-325-6152 and ask for the Service Department. Service Department Availability Monday-Friday 7:30 a.m. to 5:30p.m. and Saturday 8:00 a.m. to 12:00 a.m. CST.**

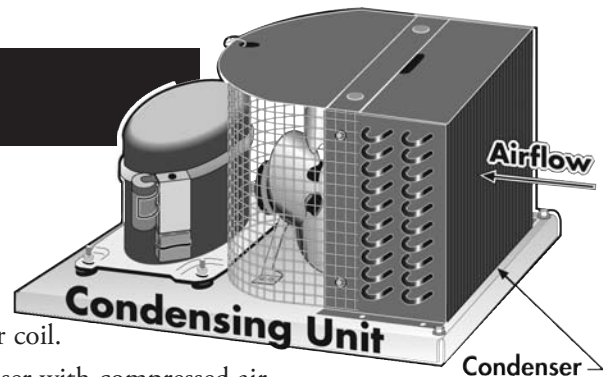

MAINTENANCE, CARE & CLEANING

## **Stainless Steel Equipment Care and Cleaning**

**CAUTION: Do not use any steel wool, abrasive or chlorine based products to clean stainless steel surfaces.**

- Stainless Steel Opponents

There are three basic things which can break down your stainless steel's passivity layer and allow corrosion to rear its ugly head.

- 1) Scratches from wire brushes, scrapers, and steel pads are just a few examples of items that can be abrasive to stainless steel's surface.
- 2) Deposits left on your stainless steel can leave spots. You may have hard or soft water depending on what part of the country you live in. Hard water can leave spots. Hard water that is heated can leave deposits if left to sit too long. These deposits can cause the passive layer to break down and rust your stainless steel. All deposits left from food prep or service should be removed as soon as possible.
- 3) Chlorides are present in table salt, food, and water. Household and industrial cleaners are the worst type of chlorides to use.

- 8 steps that can help prevent rust on stainless steel:

1. Using the correct cleaning tools

Use non-abrasive tools when cleaning your stainless steel products. The stainless steel's passive layer will not be harmed by soft cloths and plastic scouring pads. Step 2 tells you how to find the polishing marks.

2. Cleaning along the polish lines

Polishing lines or "grain" are visible on some stainless steels. Always scrub parallel to visible lines on some stainless steels. Use a plastic scouring pad or soft cloth when you cannot see the grain.

3. Use alkaline, alkaline chlorinated or non-chloride containing cleaners

While many traditional cleaners are loaded with chlorides, the industry is providing an ever increasing choice of non-chloride cleaners. If you are not sure of your cleaner's chloride content contact your cleaner supplier. If they tell you that your present cleaner contains chlorides, ask if they have an alternative. Avoid cleaners containing quaternary salts as they can attack stainless steel, causing pitting and rusting.

4. Water Treatment

To reduce deposits, soften the hard water when possible. Installation of certain filters can remove corrosive and distasteful elements. Salts in a properly maintained water softener can be to your advantage. Contact a treatment specialist if you are not sure of the proper water treatment.

5. Maintaining the cleanliness of your food equipment

Use cleaners at recommended strength (alkaline, alkaline chlorinated or non-chloride). Avoid build-up of hard stains by cleaning frequently. When boiling water with your stainless steel equipment, the single most likely cause of damage is chlorides in the water. Heating any cleaners containing chlorides will have the same damaging effects.

6. Rinse

When using chlorinated cleaners you must rinse and wipe dry immediately. It is better to wipe standing cleaning agents and water as soon as possible. Allow the stainless steel equipment to air dry. Oxygen helps maintain the passivity film on stainless steel.

7. Hydrochloric acid (muriatic acid) should never be used on stainless steel

8. Regularly restore/passivate stainless steel

## Stainless Steel Equipment Care and Cleaning

### Recommended cleaners for certain situations / environments of stainless steel

- A) Soap, ammonia and detergent medallion applied with a cloth or sponge can be used for routine cleaning.
- B) Arcal 20, Lac-O-Nu Ecoshine applied provides barrier film for fingerprints and smears.
- C) Cameo, Talc, Zud First Impression is applied by rubbing in the direction of the polished lines for stubborn stains and discoloring.
- D) Easy-off and De-Grease It oven aid are excellent for removals on all finishes for grease-fatty acids, blood and burnt-on foods.
- E) Any good commercial detergent can be applied with a sponge or cloth to remove grease and oil.
- F) Benefit, Super Sheen, Sheila Shine are good for restoration / passivation.

#### NOTE

*The use of stainless steel cleaners or other such solvents is not recommended on plastic parts. Warm soap and water will suffice.*

## LIGHT BULB REPLACEMENT

### IDL (Integrated Door Lighting)

#### WARNING

Disconnect power to cabinet before replacing light bulbs.

#### INTERIOR LIGHTS:

- Simply unscrew the light bulb(See Image 1 & 2).

#### IDL (INTEGRATED DOOR LIGHTING):

- Squeeze the plastic lampshield together and pull away from the door (See Image 3).
- Push the bulb down while pulling the spring activated lampholder up. This will give you enough clearance to take the bulb out (See Image 4).



**1**  
Interior Light



**2**  
Interior Light



**3**  
IDL (Integrated Door Lighting)



**4**  
IDL (Integrated Door Lighting)



## WARRANTY INFORMATION (U.S.A & CANADA ONLY!)

### ONE YEAR PARTS & LABOR WARRANTY

TRUE warrants to the original purchaser of every new TRUE refrigerated unit, the cabinet and all parts thereof, to be free from defects in material or workmanship, under normal and proper use and maintenance service as specified by TRUE and upon proper installation and start-up in accordance with the instruction packet supplied with each TRUE unit. TRUE's obligation under this warranty is limited to a period of one (1) year from the date of original installation or 15 months after shipment date from TRUE, whichever occurs first.

Any part covered under this warranty that are determined by TRUE to have been defective within one (1) year of original installation or fifteen (15) months after shipment date from manufacturer, whichever occurs first, is limited to the repair or replacement, including labor charges, of defective parts or assemblies. The labor warranty shall include standard straight time labor charges only and reasonable travel time, as determined by TRUE.

### ADDITIONAL FOUR YEAR COMPRESSOR WARRANTY

In addition to the one (1) year warranty stated above, TRUE warrants its hermetically and semi-hermetically sealed compressor to be free from defects in both material and workmanship under normal and proper use and maintenance service for a period of four (4) additional years from the date of original installation but not to exceed five (5) years and three (3) months after shipment from the manufacturer.

Compressors determined by TRUE to have been defective within this extended time period will, at TRUE's option, be either repaired or replaced with a compressor or compressor parts of similar design and capacity.

The four (4) year extended compressor warranty applies only to hermetically and semi-hermetically sealed parts of the compressor and does not apply to any other parts or components, including, but not limited to, cabinet, paint finish, temperature control, refrigerant, metering device, driers, motor starting equipment, fan assembly or any other electrical component, etcetera.

### 404A/134A COMPRESSOR WARRANTY

The four year compressor warranty detailed above will be voided if the following procedure is not carefully adhered to:

1. This system contains R404A or R134A refrigerant and polyol ester lubricant. The polyol ester lubricant has rapid moisture absorbing qualities. If long exposure to the ambient conditions occur, the lubricant must be removed and replaced with new. For oil amounts and specifications please call TRUE technical service department (800-325-6152). Failure to comply with recommended lubricant specification will void the compressor warranty.
2. Drier replacement is very important and must be changed when a system is opened for servicing. A drier using XH-7 desiccant or an exact replacement solid core drier must be used. The new drier must also be the same capacity as the drier being replaced.
3. Micron level vacuums must be achieved to insure low moisture levels in the system. 500 microns or lower must be obtained.

### WARRANTY CLAIMS

All claims for labor or parts must be made directly through TRUE. All claims should include: model number of the unit, the serial number of the cabinet, proof of purchase, date of installation, and all pertinent information supporting the existence of the alleged defect.

In case of warranty compressor, the compressor model tag must be returned to TRUE along with above listed information. Any action or breach of these warranty provisions must be commenced within one (1) year after that cause of action has occurred.

### WHAT IS NOT COVERED BY THIS WARRANTY

TRUE's sole obligation under this warranty is limited to either repair or replacement of parts, subject to the additional limitations below. This warranty neither assumes nor authorizes any person to assume obligations other than those expressly covered by this warranty.

**NO CONSEQUENTIAL DAMAGES.** TRUE IS NOT RESPONSIBLE FOR ECONOMIC LOSS; PROFIT LOSS; OR SPECIAL, INDIRECT, OR CONSEQUENTIAL DAMAGES, INCLUDING WITHOUT LIMITATION, LOSSES OR DAMAGES ARISING FROM FOOD OR PRODUCT SPOILAGE CLAIMS WHETHER OR NOT ON ACCOUNT OF REFRIGERATION FAILURE.

**WARRANTY IS NOT TRANSFERABLE.** This warranty is not assignable and applies only in favor of the original purchaser/user to whom delivered. ANY SUCH ASSIGNMENT OR TRANSFER SHALL VOID THE WARRANTIES HEREIN MADE AND SHALL VOID ALL WARRANTIES, EXPRESS OR IMPLIED, INCLUDING ANY WARRANTY OF MERCHANTABILITY OR FITNESS FOR A PARTICULAR PURPOSE.

**IMPROPER USAGE.** TRUE ASSUMES NO LIABILITY FOR PARTS OR LABOR COVERAGE FOR COMPONENT FAILURE OR OTHER DAMAGES RESULTING FROM IMPROPER USAGE OR INSTALLATION OR FAILURE TO CLEAN AND/OR MAINTAIN PRODUCT AS SET FORTH IN THE WARRANTY PACKET PROVIDED WITH THE UNIT.

**RESIDENTIAL APPLICATIONS:** TRUE assumes no liability for parts or labor coverage for component failure or other damages resulting from installation in non-commercial or residential applications.

**ALTERATION, NEGLIGENCE, ABUSE, MISUSE, ACCIDENT, DAMAGE DURING TRANSIT OR INSTALLATION, FIRE, FLOOD, ACTS OF GOD.** TRUE is not responsible for the repair or replacement of any parts that TRUE determines have been subjected after the date of manufacture to alteration, neglect, abuse, misuse, accident, damage during transit or installation, fire, flood, or act of God.

**IMPROPER ELECTRICAL CONNECTIONS.** TRUE IS NOT RESPONSIBLE FOR THE REPAIR OR REPLACEMENT OF FAILED OR DAMAGED COMPONENTS RESULTING FROM ELECTRICAL POWER FAILURE, THE USE OF EXTENSION CORDS, LOW VOLTAGE, OR VOLTAGE DROPS TO THE UNIT.

**NO IMPLIED WARRANTY OF MERCHANTABILITY OR FITNESS FOR A PARTICULAR PURPOSE:** THERE ARE NO OTHER WARRANTIES, EXPRESSED, IMPLIED OR STATUTORY, EXCEPT THE ONE (1) YEAR PARTS & LABOR WARRANTY AND THE ADDITIONAL FOUR (4) YEAR COMPRESSOR WARRANTY AS DESCRIBED ABOVE. THESE WARRANTIES ARE EXCLUSIVE AND IN LIEU OF ALL OTHER WARRANTIES, INCLUDING IMPLIED WARRANTY AND MERCHANTABILITY OR FITNESS FOR A PARTICULAR PURPOSE. THERE ARE NO WARRANTIES WHICH EXTEND BEYOND THE DESCRIPTION ON THE FACE HEREOF.

**OUTSIDE U.S./Canada:** This warranty does not apply to, and TRUE is not responsible for, any warranty claims made on products sold or used outside the United States or Canada.

## Free Manuals Download Website

<http://myh66.com>

<http://usermanuals.us>

<http://www.somanuals.com>

<http://www.4manuals.cc>

<http://www.manual-lib.com>

<http://www.404manual.com>

<http://www.luxmanual.com>

<http://aubethermostatmanual.com>

Golf course search by state

<http://golfingnear.com>

Email search by domain

<http://emailbydomain.com>

Auto manuals search

<http://auto.somanuals.com>

TV manuals search

<http://tv.somanuals.com>