

 **Turbosound**<sup>®</sup>  
PROEL GROUP COMPANY

# Milan

## MI5

### USER GUIDE

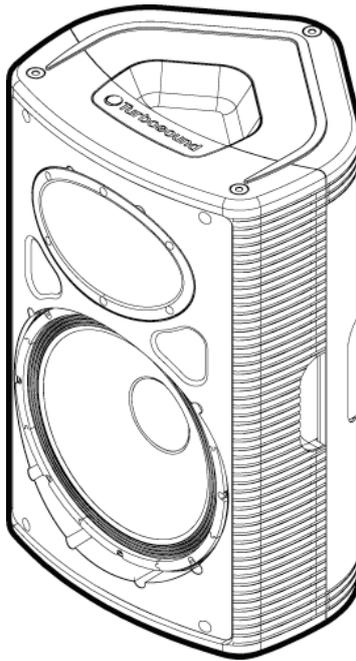

**Turbosound Ltd**  
**Star Road, Partridge Green**  
**West Sussex RH13 8RY United Kingdom**  
**Tel: +44 (0)1403 711447 Fax: +44 (0)1403 710155**  
**web: [www.turbosound.com](http://www.turbosound.com)**

Issue 1.0 © Turbosound Ltd

## Contents

<b>EC Declaration of Conformity</b> .....	<b>4</b>
<b>Safety considerations</b> .....	<b>5</b>
<b>Introduction</b> .....	<b>6</b>
Thanks.....	6
Unpacking .....	6
Contents .....	6
<b>Getting Started</b> .....	<b>7</b>
<b>Self-Powered Loudspeakers</b> .....	<b>8</b>
Signal Flow Block Diagram .....	8
<b>Bass Mode</b> .....	<b>9</b>
Using Milan with Subwoofers .....	9
Using Milan as a Floor Monitor.....	9
<b>Model Information</b> .....	<b>10</b>
Milan MI5 Self-Powered Loudspeaker.....	10
Milan MI5 Features .....	11
<b>Connector wiring</b> .....	<b>12</b>
<b>Connecting to the Milan MI5</b> .....	<b>13</b>
1. Mains Connector and Fuseholder .....	13
2. Mains Switch.....	13
3. Signal Input.....	13
4. Mic / Line Switch .....	13
5. Level Control.....	13
6. Bass Control and 7. Treble control .....	13
8. Bass Mode switch.....	14
9. Mix Out .....	14
10. Power Indicator .....	14
11. Signal Indicator.....	14
12. Limit indicator .....	14
<b>Connection Diagrams</b> .....	<b>15</b>
Small band setup using the integrated mixer and Mix Out.....	15
Stereo PA with an external mixer .....	16
Stereo PA with an external mixer and subwoofer(s) .....	17
Stereo PA with powered wedge monitors .....	18
<b>Loudspeaker Placement</b> .....	<b>19</b>
<b>Installing the Milan loudspeaker</b> .....	<b>20</b>
Using the M10 rigging points .....	20
Wall Mounting.....	20
<b>Troubleshooting</b> .....	<b>21</b>
<b>Product Dimensions</b> .....	<b>22</b>
Milan MI5 .....	22
<b>Technical Specifications</b> .....	<b>23</b>

<b>Spare Parts</b> .....	<b>24</b>
Accessories .....	24
<b>Warranty</b> .....	<b>25</b>
<b>Contact Information</b> .....	<b>26</b>
Customer Service.....	26
Product Information.....	26
<b>Notes</b> .....	<b>27</b>

## EC Declaration of Conformity

### Manufacturer

Turbosound Ltd, Star Road, Partridge Green, West Sussex, RH13 8RY, UK  
tel: +44 (0)1403 711447 fax: +44 (0)1403 710155 www.turbosound.com

### Products:

Milan MI5

### Standards:

Relevant Specifications used as basis for tests      EN55103-1:1996  
Directive 1999/5/EC

### Category

Professional apparatus for use in Commercial Light Industrial and controlled EMC environments.

### CE Marking

All products are marked in accordance with the relevant statutory requirements.

### Signatories

Simon Blackwood (Managing Director)



Dominic Harter (Sales Director)



July 2009

## Safety considerations

Before using your Milan loudspeaker please read the following information as it pertains to your safety and the reliability of your product.

1. Read and retain these instructions.
2. Heed all warnings.
3. Follow all instructions.
4. Do not use this product near water.
5. Do not install near any heat sources such as radiators, stoves, boilers, or other apparatus that produces heat.
6. Do not allow the mains cable to become damaged, twisted, cut or caught under other equipment.
7. Do not use the loudspeaker with AC mains supplies lower than 100v or higher than 240v, as damage may result.
8. Use only accessories and attachments approved by the manufacturer. If the product is to be permanently installed use only rigging hardware approved by Turbosound.
9. Unplug the loudspeaker during lightning storms or when it is not to be used for long periods of time.
10. This equipment must be grounded (earthed).
11. Be careful when lifting the loudspeaker, for instance when placing onto speaker stands or poles. Make sure that you are lifting within your personal capability.
12. Keep the exterior of the loudspeaker enclosure clean, and clean only with a dry cloth.
13. Do not install the loudspeaker in outdoor environments where the product could be subjected to moisture, excessive temperatures or prolonged UV light exposure. Electrically powered devices such as this product can present dangerous shock hazards when wet or exposed to moisture.
14. This product is not suitable for fixed installation in outdoor environments.

## Introduction

Congratulations, you have purchased a professional loudspeaker product from the Milan series of loudspeakers, designed to give you the best in audio quality and many years of reliable, trouble-free operation. It offers excellent pattern control, safe and practical rigging hardware, superior audio quality, proven reliability, ease of setup, consistent performance, and the backing of a world leader in acoustics technology including a comprehensive warranty against manufacturing defects. Please read through this manual carefully before you attempt to operate the loudspeaker system. It contains valuable information which will enable you to quickly and easily connect the loudspeakers to your outboard equipment; and important system and set-up checks.

## Thanks

Thank you for choosing a TURBOSOUND loudspeaker product for your application.

By engaging in an on-going rigorous program of research and development all TURBOSOUND products are carefully engineered for world class performance and reliability.

If you would like further information about this or any other TURBOSOUND product, please contact us. Detailed product information is available on our website at: [www.turbosound.com](http://www.turbosound.com)

We look forward to helping you in the near future.

## Unpacking

After unpacking the unit please check carefully for damage. If damage is found, please notify the carrier concerned at once. You, the consignee, must instigate any claim. Please retain all packaging in case of future re-shipment.

## Contents

Milan MI5 loudspeaker  
IEC mains cable  
User Guide  
Turbosound logo sticker

## Getting Started

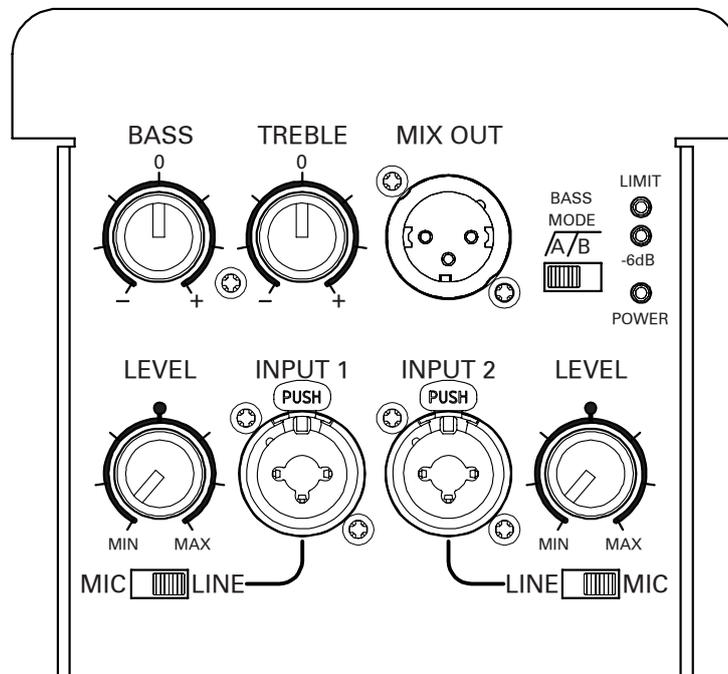

1. Turn the level controls fully anticlockwise (MIN) on both input channels.
2. Set the Bass and Treble tone controls to their centre position (no boost or cut).
3. Connect your signal sources (mixing console, keyboard, microphone, acoustic guitar) to the input connectors and select **MIC** or **LINE** as appropriate for that source.
4. If the loudspeaker is to be used as a floor monitor, or for use with subwoofers, set the **BASS MODE** switch to the 'B' position; otherwise select the 'A' position.
5. Switch on the mixer or other source and make sure the output faders or master output level controls are turned fully down.
6. Connect the AC mains cable to the Milan loudspeaker and turn on the mains switch. The blue **POWER** LED will illuminate to indicate that mains power is connected.
7. Increase the output level of the signal source to a normal operating level.
8. Slowly turn up the Milan loudspeaker's level control(s) until a suitable volume level is reached. The green **SIGNAL** LED illuminates when the input signal is -6dB from limiting. It is normal for the **LIMIT** LED to flash occasionally, but excessive or prolonged illumination indicates that the input signal is too high or additional speakers are required.
9. When shutting down the Milan system, first turn down the input level controls, then switch off the mains power before turning off the mixer or signal source.

## Self-Powered Loudspeakers

Milan series self-powered loudspeakers are equipped with an integrated Class D amplifier module, taking consistent performance, convenience and ease of use to a new level. Featuring lightweight high-power amplifiers using 48kHz DSP and operating at better than 90% efficiency, Milan eliminates the need for separate amplifier racks and controllers, as well as the attendant cabling. This makes setting up at gigs and obtaining a consistent sound in different venues a faster and simpler process.

The amplifier is exactly matched to the known parameters of the loudspeaker components, and is therefore able to produce the optimum power for the drivers. By placing the amplifier in the cabinet it is possible to keep the loudspeaker cables extremely short to eliminate resistive losses, so effectively all the power from the amplifier is transferred to the drivers.

The availability of on-board electronics provides an opportunity to build in a two-channel mixer offering both mic and line inputs with two band EQ and sophisticated DSP-based limiting. These fast-acting, frequency-dependent limiters allow you to achieve higher average sound pressure level, reduce the possibility of driver damage, and help to ensure better long-term system reliability.

A professional quality crossover network filters the low and high frequencies appropriately to each driver, to ensure that each is working in its optimum frequency band. The high-grade circuit components ensure that every loudspeaker performs consistently.

Due to the extremely high efficiency and modern, high performance power supply, the Milan amplifier module only adds less than 2 kilos to the overall net weight of the loudspeaker, and this is an important factor in portable applications where the loudspeaker is to be transported and set up frequently in a variety of venues.

## Signal Flow Block Diagram

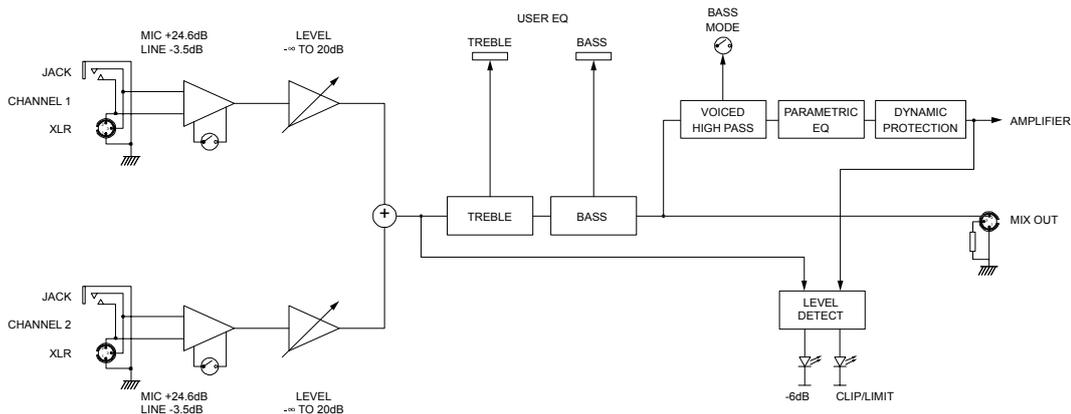

## Bass Mode

The **BASS MODE** switch introduces a 100Hz filter in the bass part of the frequency response. In the 'B' position it allows better integration of sub-bass loudspeakers with Milan MI5 loudspeakers by preventing an overlap in the bass frequencies. The subjective result is extended bass response.

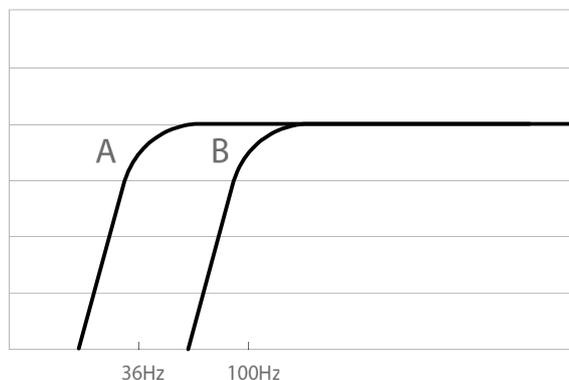

If you are using Milan without subwoofers we recommend that you select the 'A' position, which will ensure the frequency response is unaffected.

## Using Milan with Subwoofers

Improved bass response and higher overall sound pressure level can be achieved by adding sub-bass loudspeakers to the Milan system. This also reduces mechanical stress on the Milan loudspeaker's low frequency driver, since most of the low frequency content in the signal is routed to the subwoofer.

It is recommended that you connect the full range signal from the mixer first to the subwoofer(s), and from there to the Milan MI5. Make sure the **BASS MODE** switch is correctly selected to the 'B' position.

When using non-powered subwoofers, take a separate output from the mixer and run it to the sub-frequency amplifier(s). Connect directly from the mixer outputs to the Milan loudspeaker as in the example without subwoofers, but select the 'B' position on the **BASS MODE** switch to allow the majority of low frequencies to be handled by the subwoofers.



## Using Milan as a Floor Monitor

You can select the 'B' position on the **BASS MODE** switch when using Milan as a floor monitor, which will avoid any low frequency boominess due to the proximity of the floor that can detract from clear and intelligible monitor sound.

If you are using Milan as part of a larger multi-channel monitor system and where drums may be part of the monitor mix, **BASS MODE 'A'** can be selected provided that kick drum EQ is used sparingly and carefully.



## Model Information

### Milan MI5 Self-Powered Loudspeaker

The Milan MI5 is a self-powered sound reinforcement loudspeaker designed for many different portable and permanently installed applications.

It consists of a 450 watt program 15" neodymium low frequency driver, matched with a 1" neodymium high frequency compression driver on a 90° horizontal x 60° vertical horn, together with a Class D amplifier module providing two input channels and on-board DSP.

The low frequency driver is a custom-designed 15" unit using a 2.5" voice coil driven by a neodymium ring magnet. The custom-developed 1" exit HF compression driver feeds a wide dispersion Converging Elliptical Waveguide for smooth and even coverage over a wide audience area.

These high quality professional components are housed in a lightweight, stylish and durable trapezoidal moulded polypropylene cabinet that is instantly adaptable to front-of-house or floor monitoring applications. The cabinet is extensively ribbed and internally damped. This design feature increases the cabinet's rigidity and eliminates internal reflections, which translates into better transient response and improved bass reproduction. It also keeps the weight of the cabinet as low as possible.

Milan is equipped with a dual angle pole mount socket which allows it to be angled down for better coverage when used with tripod stands or for mounting on top of bass cabinets. Lifting and carrying is made easy with the provision of built-in handles on the sides, as well as a scoop handle on the top of the cabinet.

The Milan cabinet provides M10 rigging points on the top and bottom for suspending horizontally or vertically in permanent installs.

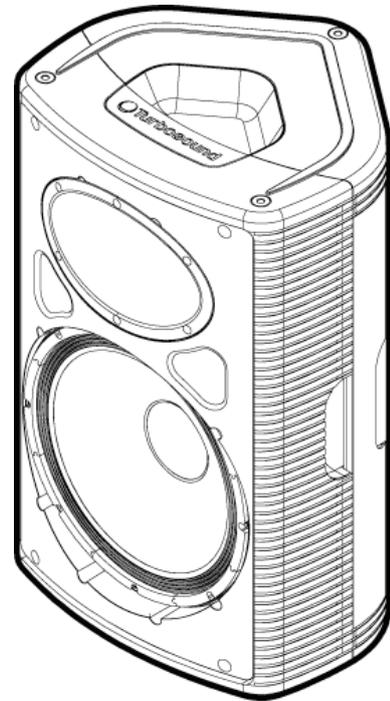

## **Milan MI5 Features**

- 450 watt lightweight digital Class D amplifier for excellent audio quality
- Internal DSP with frequency-dependent limiting ensures long term reliability
- Integrated mixer provides two input channels each with microphone and line inputs via combination jack/XLR connectors
- Two-band EQ with 12dB of cut and boost on both input channels
- Mix Out function allows daisy-chaining of Milan loudspeakers and simple expansion of your sound system
- Trapezoidal shape with symmetrical 43° wedge angle allows the loudspeaker to be used as a floor monitor
- Ergonomically placed aluminium handles for easy lifting and carrying
- Professional quality 1" high frequency compression driver with wide dispersion Converging Elliptical Waveguide
- Custom developed 15" LF driver with neodymium magnet assembly provides high performance and contributes to lower weight
- Dual angle pole mount socket allows the loudspeaker to be used vertically or angled downwards for improved coverage
- Durable, stylish and lightweight moulded composite enclosure
- Internal M10 rigging points for easy suspension in permanent installs
- Attractive powder coated and galvanised perforated steel grille

## Connector wiring

The amplifier inputs are designed to accept balanced (three conductor) connections, and it is recommended that this method be used since it offers the best rejection of noise, hum and radio interference, especially where long cable runs are involved. XLR connectors should be wired pin 2 hot, while the standard wiring for 3-pole jack plug connectors is tip hot (+ve) and ring cold (-ve) as shown below.



Some signal sources such as keyboards, acoustic guitars with on-board electronics, and some microphones commonly provide only an unbalanced output on a 2-pole jack connector. The Milan loudspeaker can handle these connections without any rewiring since pin 3 (-ve) of the input is automatically grounded by the jack plug.



If an unbalanced source is to be connected to an input channel via the XLR input connector, either 2-pole or 3-pole jack plugs can be used. In both cases pin 3 should be connected to pin 1 (ground) at the XLR as shown here.

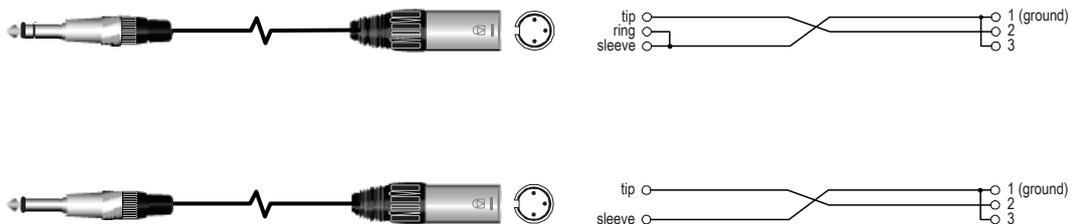

Some sources such as mp3 players or CD players commonly provide 2-pole unbalanced phono connectors, and these can be connected to a Milan input channel via either the XLR connector or jack connector. In either case wire the connectors as follows:

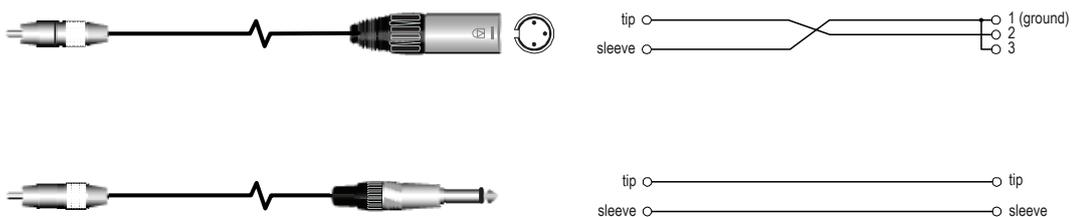

## Connecting to the Milan MI5

### 1. Mains Connector and Fuseholder

Mains power is connected to the loudspeaker via a combination IEC connector and fuseholder. The power supply is auto-sensing and can be connected to mains supplies ranging from 110 volts to 240 volts AC without the need to change any settings.

### 2. Mains Switch

Rocker switch turns mains power on to the loudspeaker. Make sure the level controls are fully off (MIN) before switching on.

### 3. Signal Input

These combo female XLR/jack connectors accept both XLR connectors and mono (2 pole) or stereo (3 pole) ¼" jack plugs for use with a variety of balanced and unbalanced microphones, instruments and line sources. The inputs are balanced to avoid hum loops and RF interference, and are wired pin 2 hot, pin 3 cold.

### 4. Mic / Line Switch

Selects the input for that channel to accept either a low level, low impedance microphone, or a high level, high impedance source such as a mixing console, keyboard or acoustic instrument with onboard electrics. The mic input is not suitable for condenser microphones that require phantom power.

### 5. Level Control

Rotary level control which attenuates the input signal level of the connected instrument / line source for that input channel. The range (mic) is from  $-\infty$  (MIN) to +16.5dB (MAX) and (line) from  $-\infty$  (MIN) to +40.6dB (MAX).

### 6. Bass Control and 7. Treble control

The bass control provides  $\pm 12$ dB of shelving at 200Hz, and the treble control provides  $\pm 12$ dB of shelving at 4kHz. Always use equalisation sparingly, aiming to cut rather than boost especially when the loudspeaker is used near boundaries such as walls or floors.

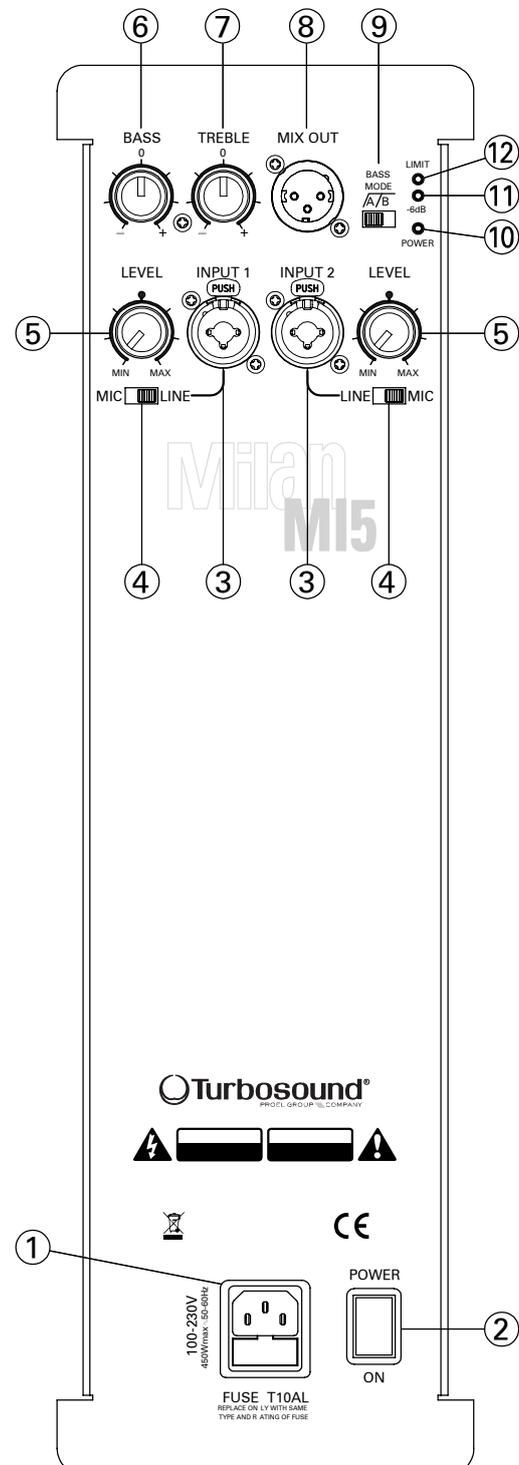

## **8. Bass Mode switch**

This slide switch introduces a fourth order high-pass filter in the lower part of the frequency response at 100Hz, and is useful to avoid boominess due to proximity to the floor when the Milan loudspeaker is used as a floor monitor. The bass mode high-pass should also be selected when the Milan MI5 is used with sub-bass loudspeakers. This allows bass frequencies to be routed appropriately to the sub-bass speakers, avoiding an overlap between these and the Milan MI5, and giving greater clarity and definition to the overall sound.

## **9. Mix Out**

A balanced line level output on a balanced male XLR that connects to additional powered Milan loudspeakers. This output contains a mix of all connected sources and is post-EQ, although it is independent of the bass mode switch. Note that adjusting the equalisation will similarly affect any additional Milan loudspeakers connected from this output.

## **10. Power Indicator**

Illuminates blue to indicate that mains power is connected and powered up.

## **11. Signal Indicator**

Illuminates green when the signal level reaches -6dB, and is a useful indicator of the input signal approaching the limiter threshold.

## **12. Limit indicator**

Illuminates red when the signal level approaches maximum and the limiters start working. Frequent and/or continuous lighting of limit LED indicates overdriving. If this occurs reduce the input level to the loudspeaker or enlarge your system with additional loudspeakers.

## Connection Diagrams

### Small band setup using the integrated mixer and Mix Out

The built in two channel mixer allows the simultaneous use of either two low impedance dynamic microphones, a microphone and line level source, or two line level sources. The line level source could be an acoustic instrument such as a guitar with either passive or active on-board electronics, a keyboard, or MP3 player. Connect a dynamic mic directly to either of the combo jack/XLR input connectors, switch the **MIC/LINE** switch to **MIC** and adjust the volume level. Connect line sources to either of the combo jack/XLR connectors, switch the **MIC/LINE** switch to **LINE** and adjust the volume control. More mics and sources can be connected by using the MIX OUT function to daisy-chain to additional Milan loudspeakers.

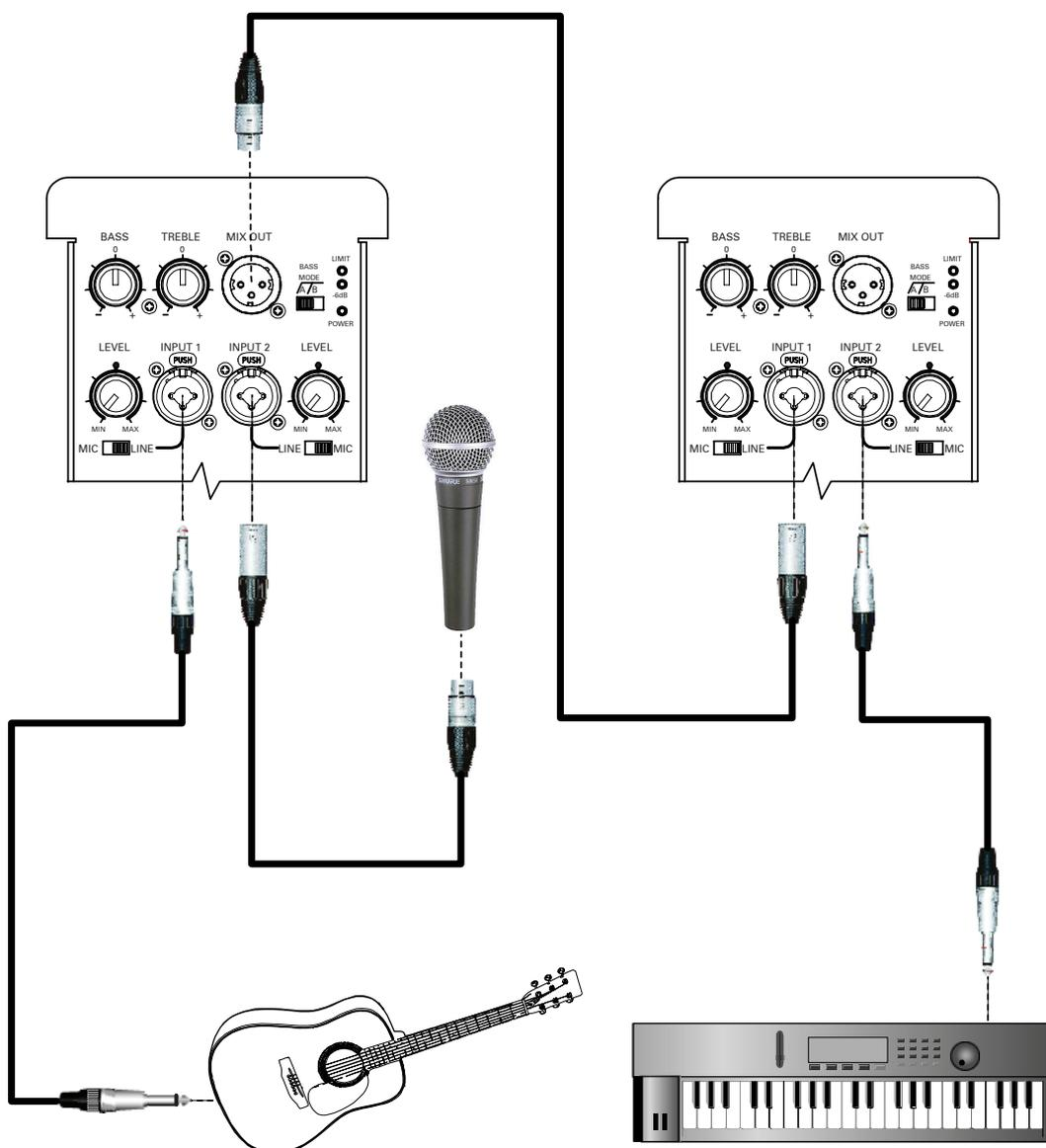

## Stereo PA with an external mixer

Two Milan loudspeakers form the left and right elements of a stereo PA setup with all signal sources connected to an external mixing console. Ensure that the mic/line switch is set to **LINE** on both loudspeakers. Set the **BASS MODE** switch to the 'A' position when not using subwoofers. Bring up the master faders on the mixer, ensuring that the outputs are not clipping, and then adjust both loudspeakers' level controls to the desired loudness. For consistent balance and response set the tone controls to approximately the same positions on both cabinets.

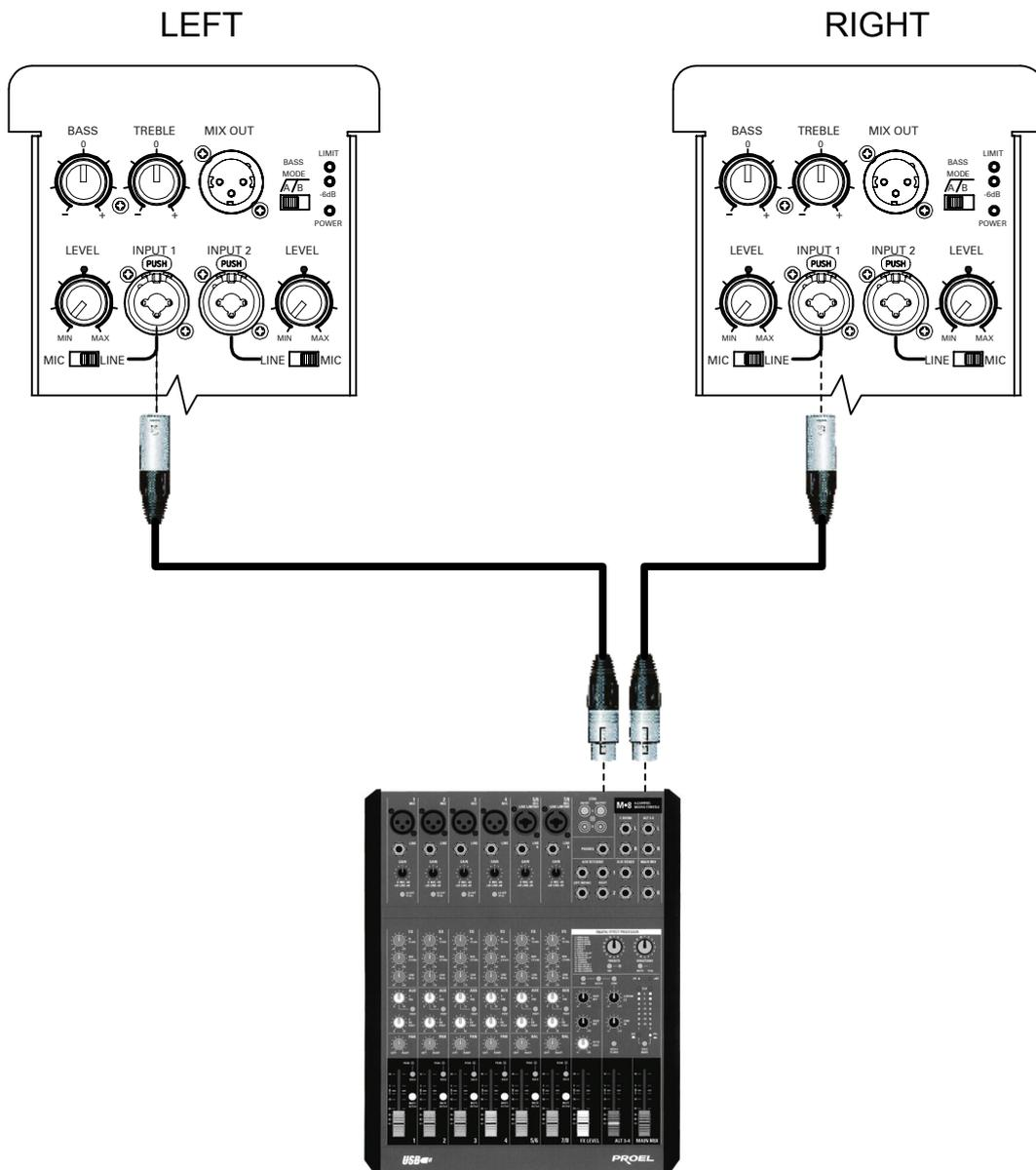

## Stereo PA with an external mixer and subwoofer(s)

In this example, sub frequencies are routed to a separate subwoofer(s) in order to gain extended frequency response and higher overall sound level. Connect the mixer output first to the subwoofers and then loop up to the Milan loudspeakers. Set the **MIC/LINE** switch to **LINE** and set the **BASS MODE** switch to the '**B**' position to roll off the low frequencies to the Milan MI5 loudspeakers. The tone controls on both cabinets should be set to the same positions, nominally flat to begin with. Ensure that the mixer outputs are not clipping, and then adjust both loudspeakers' level controls to the desired loudness.

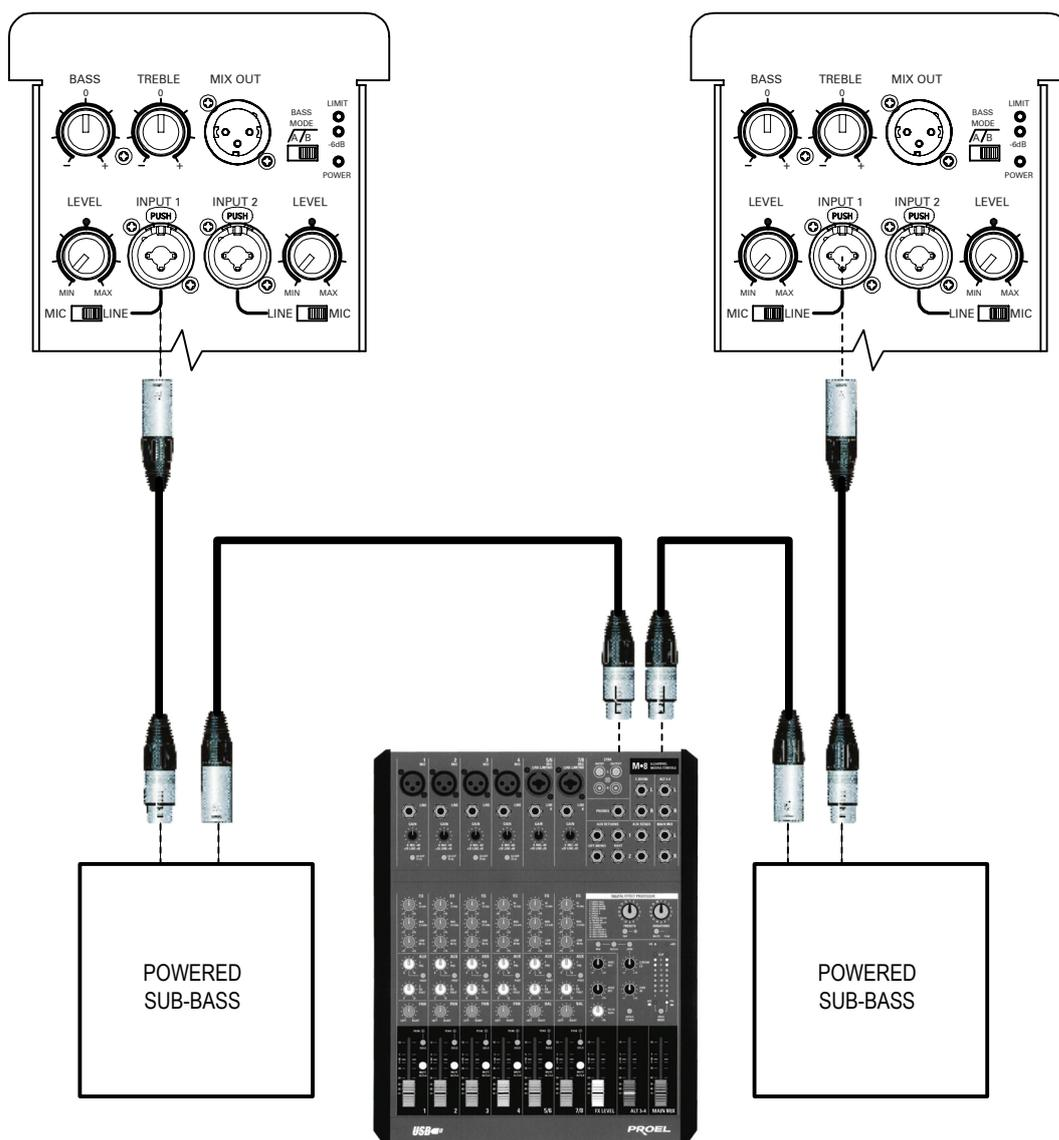

## Stereo PA with powered wedge monitors

On larger gigs a separate monitor system provides good quality foldback for individual performers and helps to keep the PA sound less cluttered. Select the **BASS MODE 'A' or 'B'** position as required on the Milan monitors.

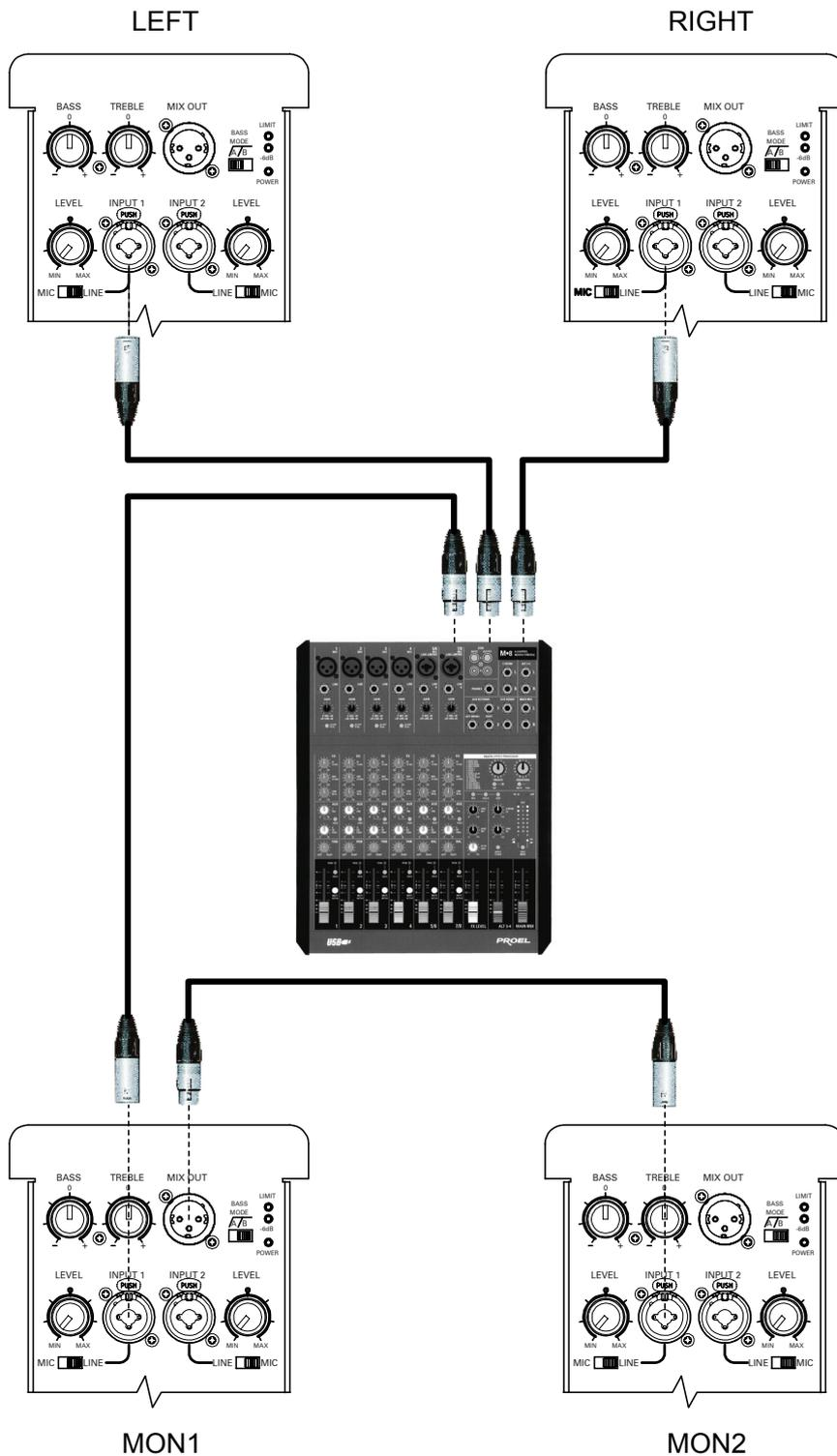

## Loudspeaker Placement

In order to avoid the possibility of feedback locate the loudspeakers in front of your microphones and do not point microphones directly at the front of a loudspeaker.

When using speaker stands, try to raise the loudspeakers as high as practically possible (at least higher than the heads of the audience) since people are very good absorbers of sound, especially at high frequencies. You also have the option to point them down using the alternate angle provided for by the built-in dual angle pole holder. Doing this will improve the coverage for both near and far audience members.

**SAFETY PRECAUTIONS:** make sure that any speaker stands you use are capable of taking the weight of the loudspeaker, and that stands are placed on a flat, level and stable surface. Make sure that the legs do not present a trip hazard. Take care when lifting the speakers on to the stand; ask someone else to help you if needed.

The same applies to using Milan loudspeakers mounted on straight poles on top of bass cabinets or subwoofers. Adjustable height poles or stands allow you to fine tune the height of the loudspeakers to suit your venue.

Do not place your loudspeakers too close to turntables as this may induce rumble or low frequency feedback from the tone arms. Isolate turntables on shock mounts.

Use equalisation sparingly. Start with the bass and treble controls at their neutral position (no boost or cut). Cut a little bass to tame any boomy frequencies in the room, and add a little treble to help vocal intelligibility.

Consider adding subwoofers and/or further loudspeakers if the overall sound level or low frequency response is not enough for the room.

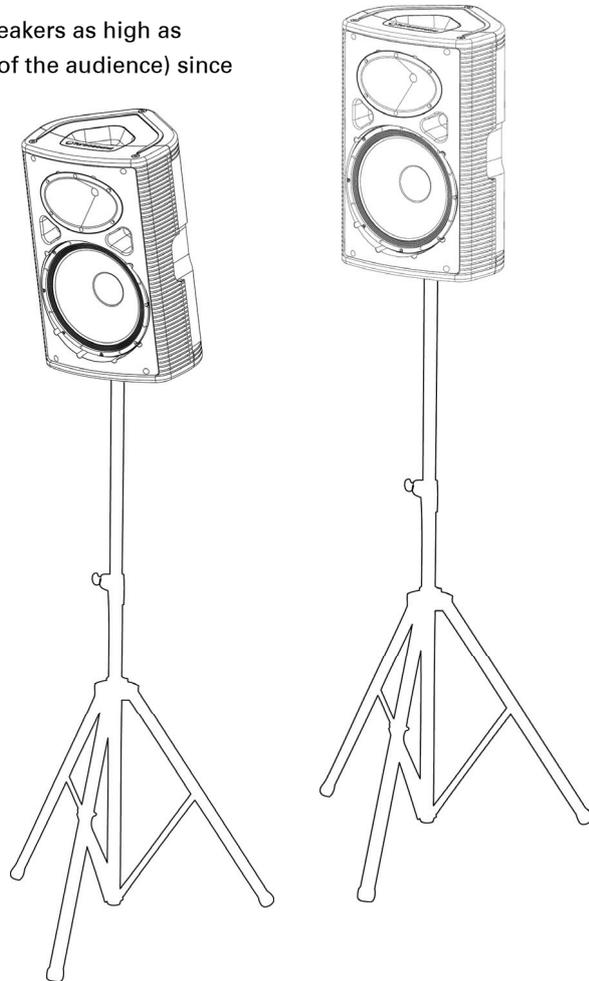

## Installing the Milan loudspeaker

### Using the M10 rigging points

The Milan loudspeaker can be permanently installed in a venue, suspended from eyebolts fitted to the internal M10 rigging points on the top and bottom of the cabinet. Three possible orientations are available: vertically upright, or upside down to position the high frequency driver closer to the audience, or sideways if required.

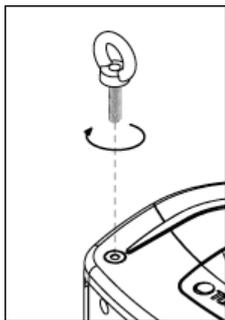

Insert M10 load-rated shoulder eyebolts into the threaded rigging points and tighten. The front rigging points should take the majority of the load while the rear rigging point should be used for angling the cabinet downwards only.

When installing the cabinet sideways, pick up from either of the two front eyebolt pairs, and bridle the two rear eyebolt points to provide a single pull-back for adjusting the downward angle.

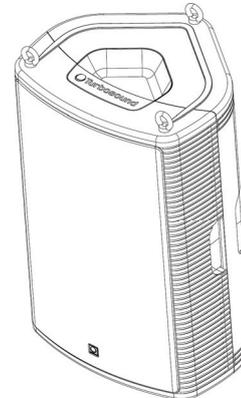
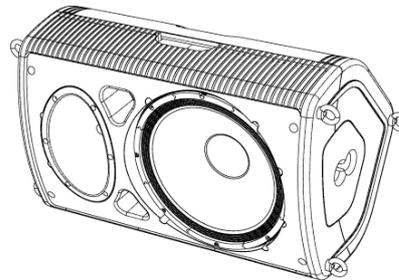

### Wall Mounting

The Milan loudspeaker can be conveniently wall mounted using the PB-55 pole mount wall bracket, which simply locates into the pole mount socket in the bottom of the cabinet.

Mount the bracket to the wall using suitable fixings, and locate the loudspeaker onto the pole mount bracket. Rotate and angle the loudspeaker to optimise coverage and tighten the locking mechanism to stop the loudspeaker from being inadvertently removed.

## Troubleshooting

Fault	Check	Action
No power to the loudspeaker	Is the mains lead plugged in?	Connect the mains lead
	Is the mains outlet live?	Check the mains outlet or switch to another outlet
	Is the power switch on?	Press the mains switch
No sound / quiet sound	Is the level control turned down (anti-clockwise)?	Turn the control slowly clockwise
	Is the source sending a signal?	Verify signal at the source output. Un-mute muted outputs or mixer channels. Check cables and/or replace
	Is the mic/line switch set incorrectly?	Change mic/line setting to correct source
No sound from connected microphone	Is the microphone a condenser type needing phantom power?	Milan does not supply +48v phantom power. Use a dynamic microphone or connect to a mixer with phantom power
No sound although loudspeaker is on	Is the loudspeaker in protect mode?	Turn off the mains switch, unplug the loudspeaker before reconnecting
	Does the loudspeaker remain in protect mode?	Refer to qualified service personnel
Distorted sound	Is the input signal level too high?	Reduce mixer or preamp level
	Is the mic/line switch set incorrectly?	Change mic/line setting to correct source
Distorted sound, limit LED is on continuously	Are the volume controls set too high?	Reduce volume controls or use additional loudspeakers
Hum or noise	Are the connected sources balanced?	Use balanced cables and 3-pole connectors wherever possible. Check wiring.
	Ground loops?	Lift audio ground on affected device with adapter
	Are signal cables near or running parallel to mains cables?	Move signal cables

## Product Dimensions

### Milan MI5

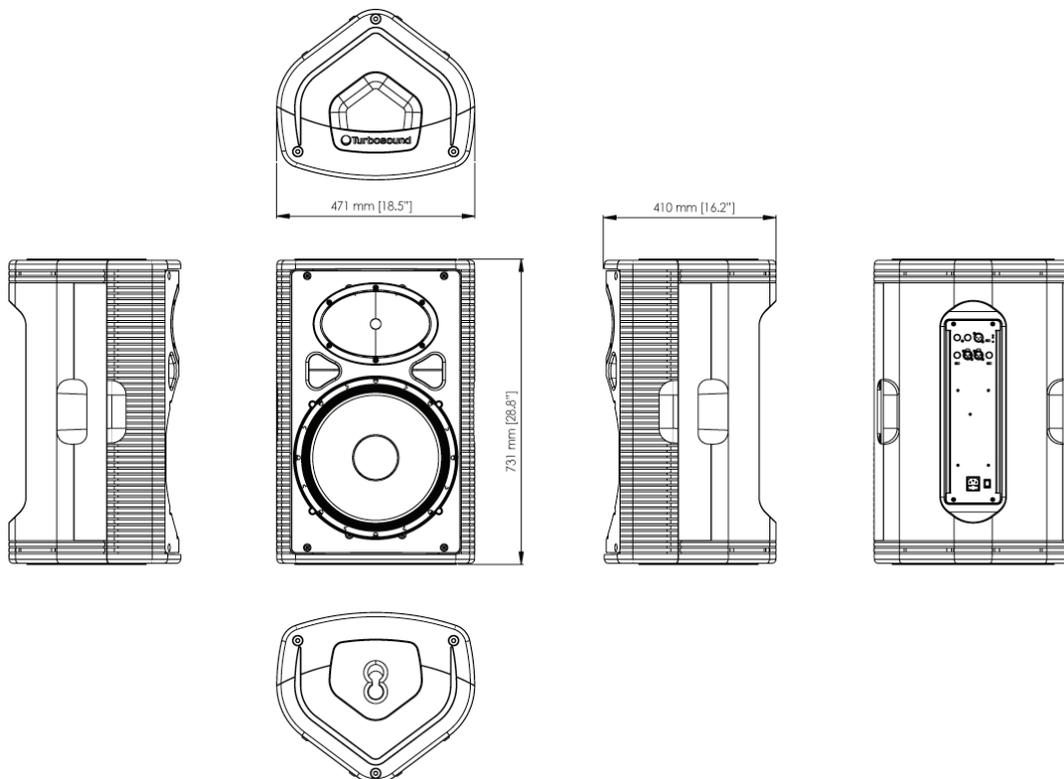

## Technical Specifications

Milan MI5	
Dimensions	720mmH x 470mmW x 400mmD (28.3" x 18.5" x 15.7")
Net weight	22kg (48.4lbs)
Frequency range	36Hz – 17kHz $\pm$ 3dB 23Hz – 22kHz $\pm$ 10dB
Dispersion	90°H x 60°V @ -6dB points
Max SPL (cont/max)	125dB/131dB
Construction	Injection-moulded polypropylene enclosure, self-coloured in dark blue. Three recessed carrying handles. Integral dual-angle pole mount socket. Powder coated galvanised perforated steel mesh grille
Connectors	Input: 2 x combo jack/female XLR, wired pin 2 hot Mix out: XLR male, wired pin 2 hot IEC mains connector with integrated fuseholder
Controls	Level control (each channel) 4 <sup>th</sup> order high-pass filter at 100Hz (bass mode) Mains on/off Bass and treble controls Mic/line switches
Indicators	Signal LED (green) Limit LED (red) Power LED (blue)
Rigging options	6 x M10 threaded internal rigging points

## Spare Parts

Stock Code	Model	Description
LS1530	LS-1530	15" (381mm) low frequency driver
04A9330	CD-118	HF compression driver
05B9320	RD-116/118	Replacement HF diaphragm
07A090	MG-MI5	Metal grille (with badge)

## Accessories

Stock Code	Model	Description
07B508/0.6	PA-60	Speaker pole 35mm x 60cm long
07B508	PA-90	Speaker pole 35mm x 90cm long
07B508/1.0	PA-100	Speaker pole 35mm x 100cm long
07B508/1.2	PA-120	Speaker pole 35mm x 120cm long
07B830	PB-55	Pole mount wall bracket
07B392	EB-10/18	M10 shoulder eyebolt

## Warranty

All products in this manual are warranted by Turbosound Limited to the original end-user purchaser against defects in workmanship and materials used in its manufacture for a period of two (2) years from the date of shipment to the end user.

Faults arising from misuse, unauthorised modifications or accidents are not covered by this warranty. No other warranty is expressed or implied.

This warranty does not affect any statutory rights of the purchaser.

Should any fault develop with a component of your Turbosound system the faulty unit should be sent, in its original packaging, to the supplier or your local authorised Turbosound dealer with the shipping prepaid.

You should include a written statement listing the faults found, and the product serial number must be quoted on all correspondence relating to the claim.

**IMPORTANT:** We recommend you record your purchase information here for future reference.

Dealers Name: .....

Address: .....

.....

.....

Phone No: .....

Invoice/Receipt No./Date . .....

Serial number: .....

.....

.....

In keeping with our policy of continual improvement, Turbosound Limited reserves the right to alter specifications without prior notice.

## **Contact Information**

Turbosound Ltd  
Star Road  
Partridge Green  
West Sussex RH13 8RY  
United Kingdom

## **Customer Service**

If your product requires servicing please contact your local distributor or retailer. A complete list is available on our website at:  
[www.turbosound.com/distrib/distribs.php](http://www.turbosound.com/distrib/distribs.php)

## **Product Information**

You can find full details on all our products on the internet at:  
[www.turbosound.com/products](http://www.turbosound.com/products)

## Notes



## Free Manuals Download Website

<http://myh66.com>

<http://usermanuals.us>

<http://www.somanuals.com>

<http://www.4manuals.cc>

<http://www.manual-lib.com>

<http://www.404manual.com>

<http://www.luxmanual.com>

<http://aubethermostatmanual.com>

Golf course search by state

<http://golfingnear.com>

Email search by domain

<http://emailbydomain.com>

Auto manuals search

<http://auto.somanuals.com>

TV manuals search

<http://tv.somanuals.com>