



TCS SERIES

**TCS-C50T
Ceiling Speaker**

USER MANUAL

**Turbosound Ltd.
Star Road, Partridge Green
West Sussex RH13 8RY England**

**Tel: +44 (0)1403 711447
Fax: +44 (0)1403 710155
www.turbosound.com**

Issue 1.1 August 2006
Copyright © 2006 Turbosound Ltd.

Contents

Introduction	3
Thanks	3
Unpacking	3
Product Summary	4
General Features.....	4
Model Information	5
TCS-C50T	6
System Considerations	7
Amplifier Requirements	7
Crossovers and Processors	8
Installation Procedure	9
Painting the Loudspeaker	12
Painting before Installation	12
Painting the Speaker with the Ceiling.....	12
Cable Recommendations	13
Servicing Information	14
Removal of the low frequency woofer	14
Removal of the high frequency tweeter	14
About EASE Data	15
Overview	15
Use of Turbosound EASE data.....	16
Technical Specifications	17
Spares List	18
Warranty	19
Notes	21

Introduction

Congratulations, you have just purchased a professional loudspeaker product from the TCS Series sound contracting loudspeaker range, designed to give you the best in audio quality and many years of reliable, trouble free operation. It offers excellent pattern control, superior audio quality, full technical documentation including EASE data, and a comprehensive warranty against manufacturing defects. Please read through this manual carefully before you attempt to operate the loudspeaker system. It contains valuable information enabling you to quickly and easily connect the loudspeakers to your amplifiers, important system and set-up checks.

Thanks

Thank you for choosing a TURBOSOUND TCS Series loudspeaker product for your application. Please spare a little time to read the contents of this manual, so that you obtain the best possible performance from this unit.

All TURBOSOUND products are carefully engineered for world class performance and reliability.

If you would like further information about this or any other TURBOSOUND product, please contact us. Detailed product information is available on our web site at www.turbosound.com

We look forward to helping you in the near future.

Unpacking

After unpacking the unit please check carefully for damage. If damage is found, please notify the carrier concerned at once. You, the consignee, must instigate any claim. Please retain all packaging in case of future re-shipment.

Package Contents

Product Summary

General Features

TCS series ceiling loudspeakers are designed for use in a wide variety of fixed installation applications that require professional sound quality, ranging from cafés, pubs, bars and restaurants to retail stores, nightclubs, live music venues and houses of worship.

- High-grade speaker components are matched with an internal passive crossover to ensure a seamless transition between the HF and LF drivers.
- Products conform to BS5839 and IEC/EN 60849 fire prevention standards
- Architecturally friendly design ensure that the loudspeakers can be effectively and easily blended into any environment
- High quality line transformer supplied as standard, enabling connection to all 70volt and 100volt line distributed systems, as well as providing a low impedance option.
- Steel back can for optimum acoustic performance, optionally supplied without back can where space above ceilings is limited.
- Paintable ABS speaker can be matched to a specific decor
- TCS Series ceiling loudspeakers are fully supported with EASE polar data (available to download from the Turbosound web site at www.turbosound.com). This enables accurate and predictable results when specifying sound systems in a given venue.

Model Information

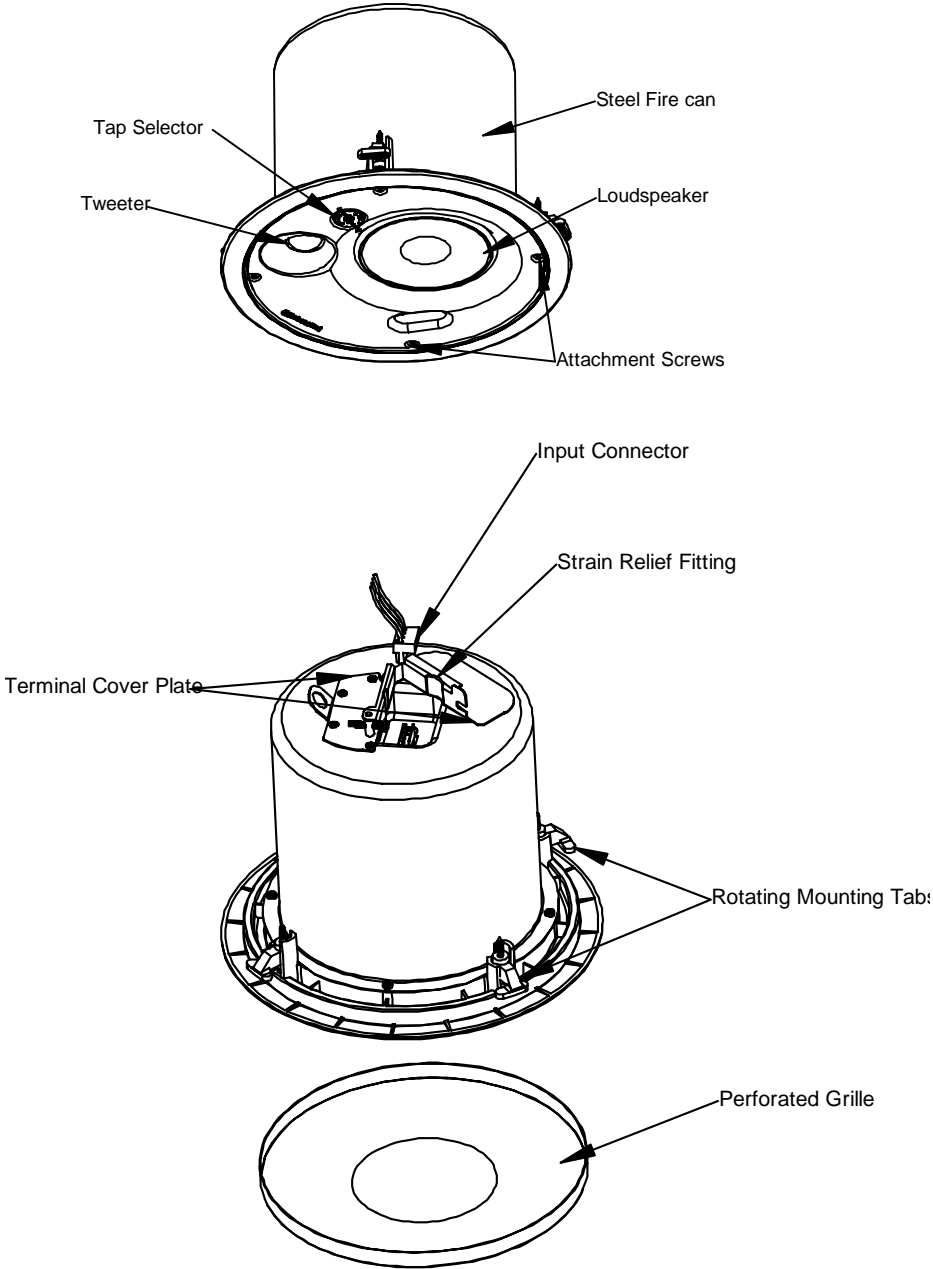

TCS Compact series

TCS-C50T

The TCS-C50T is a high quality full range two-way passive ceiling loudspeaker designed for use in background sound reinforcement applications in a wide range of fixed installations such as restaurants, retail shops, hotels, cafes, airports, boardrooms, conference centres, nightclubs, pubs and bars.

It consists of a front loaded 5" bass/mid frequency driver and a 1" ferrofluid-cooled neodymium soft dome tweeter, matched with an internal passive crossover network, in an easy-mount fire-retardant paintable ABS ceiling frame with a perforated mesh grille.

The TCS-C50T is rated at 75 watts r.m.s., and has a usable frequency range of 75Hz to 22kHz. It features a wide, conical dispersion pattern suitable for all high quality background music and speech applications.

An optional universal tile grid is designed to fit into any ceiling grid, allowing the cabling to be pre-terminated before the speaker is located, and secured using the four quarter-turn fixing tabs.

The TCS-C50T is supplied as standard with a constant voltage transformer for use on all 70 volt and 100 volt line distributed systems. Four power taps plus the low impedance setting can be selected via an easily accessible switch located behind the removable speaker grille. The TCS-C50T conforms to BS5839 fire prevention standards, as well as IEC/EN 60849.

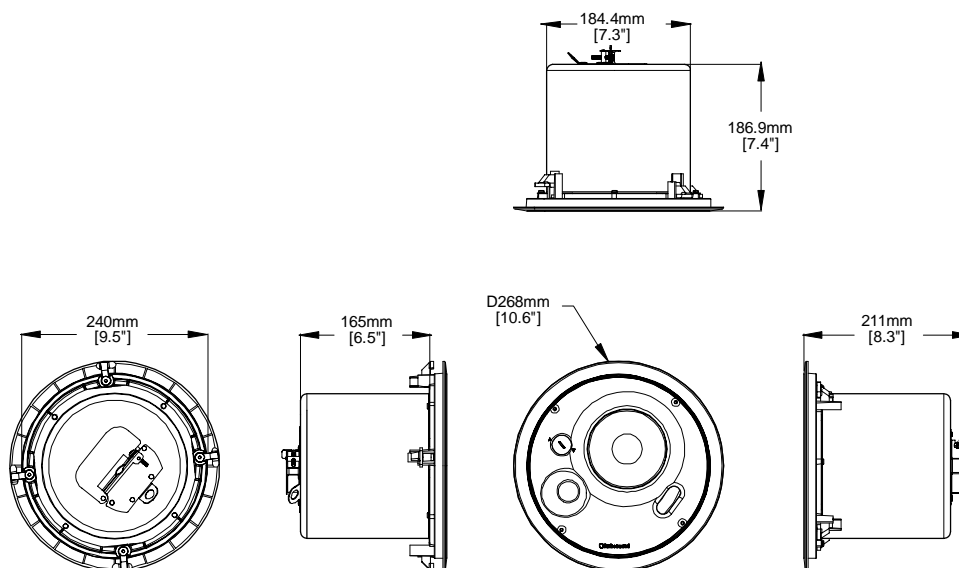

System Considerations

Amplifier Requirements

Turbosound loudspeaker enclosures should be driven by high quality power amplifiers designed for true professional use. Such amplifiers will have balanced inputs, DC and RF fault protection, and well designed cooling systems for reliability.

For low impedance systems the 'program' power, listed in the loudspeaker's technical specification, is the best guide to the size of amplifier required for general purpose applications. The amplifier should be capable of delivering long term broadband power equal to the loudspeaker's program power rating at the loudspeaker's stated nominal impedance. This approach allows sufficient headroom to generate good dynamic range.

RECOMMENDED AMPLIFIER POWER RATINGS:

The amplifier's rated r.m.s. continuous power output (20Hz – 20kHz, per channel) should be equal to the program power handling of the loudspeaker at its nominal impedance.

It should be understood that overdriving an insufficiently powered amplifier is more likely to cause loudspeaker damage – the total energy in a heavily clipped signal is far higher than in an unclipped signal – than operating a more powerful amplifier within its ratings. In general, the more powerful the amplifier the better it will sound, provided that it is not also driven into sustained clipping.

All the equipment in the system before the system controller should be set up for 0dBV (775mV) maximum output. One controller can be used to feed several amplifiers as long as all the amplifiers are the same (or have the same gain ratings). More than one controller may be required if the amplifiers are of different gain or type. Please contact your dealer if you require help in this area.

In a distributed system the amplifiers must be capable of supplying broadband power equivalent to the sum of the power rating of the loudspeakers (taking into account the individual power taps selected) connected to that particular amplifier channel.

Turbosound recommends the T-series amplifiers for use with the TCS Compact series system.

Crossovers and Processors

The TCS-C50T is a passive loudspeaker system. This means that it requires only one amplifier channel for correct operation, the frequency splitting between the low frequency driver and the high frequency driver being accomplished by the internal passive crossover network.

If subwoofers are used, additional amplifier channels and external electronic crossovers may be required. The Turbosound LMS-D24/26 digital management systems are recommended for this purpose.

Installation Procedure

1. Select the ceiling tile(s) to be used for mounting the loudspeaker(s) and remove it from the ceiling. Mark the cutout either by tracing from the cardboard template supplied with the loudspeaker, or by placing the tile bridge on the rear side of the tile, making sure that it is centred in both directions. Cut the hole with a knife or with a circular cutter set to 240mm (9 7/16").

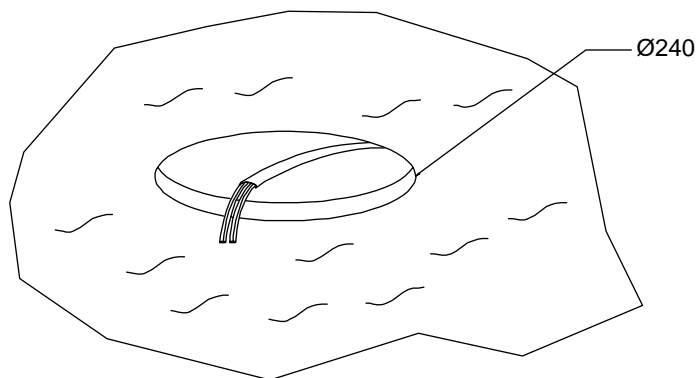

2. Remove the loudspeaker grille by pushing on the speaker attachment tabs.



Loosen the four attachment screws and fold the tabs sideways until they touch the steel back can, allowing the speaker to pass freely through the cutout. Assemble the speaker, tile bridge and tile together and tighten the attachment screws to tighten the mounting tabs. Note that the first 1/4 turn rotates the tab outwards and away from the can, and subsequent turns tighten the tab down onto the ceiling tile. **DO NOT OVERTIGHTEN.**

3. The tile grid is designed to fit either 24" or 600mm wide tiles. The tile grid does not physically attach to the T-grid struts; instead the inverted V-shapes at the ends sit over the top of the T-grid struts. During normal circumstances the speaker is supported by the edge of the tile. In the unlikely event that the tile should come out or fall apart, the ends of the tile grid are designed to catch onto the T-grid, thereby preventing the loudspeaker from falling.

TCS Compact series

4. Connect the wiring to the removable connector. A 4-way connector is supplied with the loudspeaker. Strip the insulation back by 5mm (3/16"), insert the bare ends of the wire into the connector (do not tin the wire) and screw down the hold-down screw with a small flat blade screwdriver.

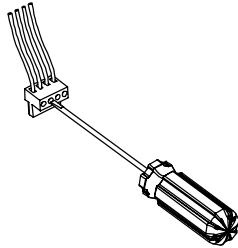

There are two possible connection strategies, depending on the desired circuit result when a single unit is disconnected for trouble shooting or servicing:

- **Parallel Input Terminals.** This allows the circuit to remain intact whenever a speaker is disconnected. Connect the outgoing pair of wires to the same terminals as the incoming pair of wires.

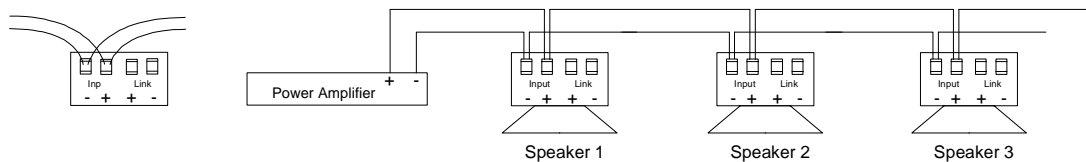

- **Loop-through Terminals.** All loudspeakers after this unit will be disconnected, helping to isolate problems to a section of the distributed line while leaving the wires connected to the connector.

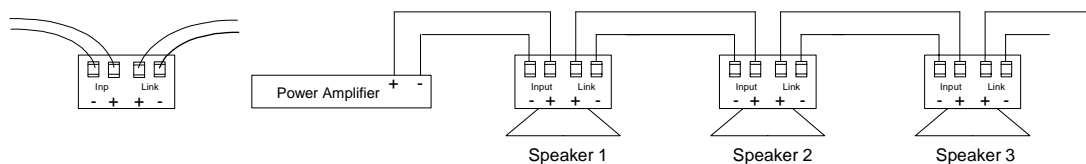

5. Plug the connector into the socket in the loudspeaker's terminal cup. The connector is polarised to avoid the possibility of mis-connection.

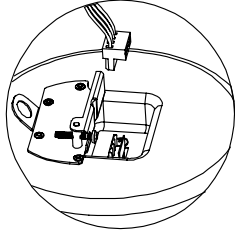

6. The terminal cover also acts as the strain relief. Rotate the cover clockwise and tighten the retaining screw.

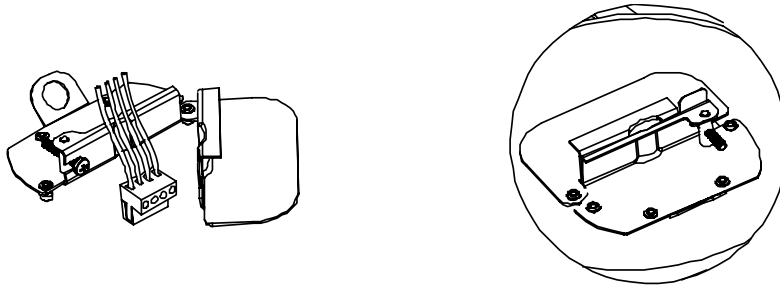

7. Attach the safety lanyard to a separate support point. Consult construction codes in your region.
8. Insert the speaker, together with the tile grid and tile, into the ceiling and allow its weight to settle down onto the grid.
9. Adjust the voltage tap selector for desired level. The selector is located on the front baffle, and should be adjusted before fitting the grille. In some installations it may be preferable to leave grilles off until final adjustment of the tap selectors has been completed for all loudspeakers.

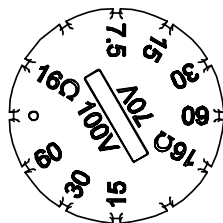

10. Fit the loudspeaker grille. Orientate the grille such that the logo is facing in the desired direction, and press the grille firmly into place until it is flush with the rim.

Painting the Loudspeaker

Painting before Installation

The speaker's white finish matches most décor schemes and does not need further finishing. However where interior design requires an alternative colour this can be easily accomplished. The speaker can either be painted before installation, or where the rim needs to be finished at the same time as the ceiling, the rim can be painted after locating in the ceiling.

The speaker will accept almost any type of emulsion or oil-based paint. Two coats are recommended.

Clean the rim and grille with a light solvent such as white spirit. Do not use gasoline, kerosene, acetone, MEK, paint thinner, harsh detergents or other chemicals, all of which may damage the loudspeaker.

After cleaning, apply two coats of paint, using a roller or brush, or by spraying.

Painting the Speaker with the Ceiling

Using the paint shield provided, paint the speaker and remove the shield. To paint the grille, first remove the logo and grille cloth backing. It is advisable to spray the grille to avoid the mesh becoming clogged with paint from a roller or brush, which may impair the sound quality. Replace the grille cloth.

Cable Recommendations

Heavy duty loudspeaker cable should always be used, with a minimum wire size of 12 gauge (1.5mm²), and preferably 10 gauge (2.5mm²) for longer runs, keeping the run as short as possible. This helps to avoid wasting amplifier power in the resistance of the cable. High cable resistance also lowers the damping factor of the amplifier which affects its ability to control loudspeaker cone movement.

Losses due to undersized cable and long runs are clearly illustrated in the table below. Please use this table to determine the most suitable cable size and maximum run for your particular application.

Nominal Cable Area (mm ²)	Cable Length (m)	Cable Resistance (W)	Voltage Drop (%) 8 ohms		Sensitivity Loss (dB)	
			8W	4W	8W	4W
1.5	5	0.07	0.8	1.6	-0.1	-0.1
	10	0.13	1.6	3.2	-0.1	-0.3
	25	0.33	4.0	7.7	-0.4	-0.7
	50	0.67	7.7	14.3	-0.7	-1.3
	100	1.33	14.3	25.0	-1.3	-2.5
2.5	5	0.04	0.5	1.0	0.0	-0.1
	10	0.08	1.0	2.0	-0.1	-0.2
	25	0.20	2.4	4.8	-0.2	-0.4
	50	0.40	4.8	9.1	-0.4	-0.8
	100	0.80	9.1	16.6	-0.8	-1.6
4.0	5	0.02	0.3	0.6	0.0	-0.1
	10	0.05	0.6	1.2	-0.1	-0.1
	25	0.12	1.5	3.0	-0.1	-0.3
	50	0.25	3.0	5.8	-0.3	-0.5
	100	0.50	5.8	11.0	-0.5	-1.0

note : Figures based on specifications supplied by Van Damme Cables (VDC)

Servicing Information

If any of the drive units in your TCS series product should cease functioning and need a replacement re-cone or diaphragm, you are advised to remove the faulty unit from the installation, remove the faulty drive unit(s) and send it to a professional service centre authorised to repair Turbosound loudspeakers.

Removal of the low frequency woofer

The perforated steel loudspeaker grille is a push fit in the loudspeaker frame. To remove the grille, using a pointed object such as a pin inserted through the mesh of the grille, gently lever the grille away from the frame. Set the grille aside for later re-assembly.

Undo the screws holding the back can in place and place to one side. The low frequency drive unit will be accessible once the line transformer has been removed from the back of the loudspeaker frame. Make a note of the driver terminal polarity for later reconnection. Disconnect the cables from the drive unit and completely remove the driver from the speaker being careful not to damage the cone or suspension. Do not place the driver near to any equipment or media that may be adversely affected by strong magnetism, e.g. CRT monitors or tape of any kind.

Removal of the high frequency tweeter

Disconnect the cables from the tweeter, making a note of the driver polarity for later reconnection. Undo the screws holding the tweeter in place and carefully lift it out and away from the speaker. Do not place the driver near to any equipment or media that may be adversely affected by strong magnetism, e.g. CRT monitors or magnetic tape of any kind.

To reinstate the driver(s) simply reverse the above procedure, making sure you observe the correct polarity when reconnecting the cables back into the terminals of the drive units.

About EASE Data

Sound system projects are more likely to go to plan when you have a reliable indicator in advance of how the speaker system will perform in the venue. Turbosound engineers are able to assist you with your system design using the industry-standard EASE program to aid in the quest to find the perfect system for the job. Although we cannot replace the role of an acoustical consultant, we can provide a good indication of system performance to back up the proposal.

Statistically, more jobs are won and more sales are made when a project has been properly and scientifically designed, along with the facility to show the client a convincing visual representation of the finished design. This cuts a large amount of guesswork out of the process, and is the reason why we actively encourage you to make use of our design resources to help you or your customers to win that next job. EASE is also a useful tool for addressing acoustic issues in the venue, for example to justify adding acoustic treatment to a room such as cladding a wall or balcony face. Having a graphical model can strengthen the proposal and ultimately ensure a better result.

Overview

EASE (Enhanced Acoustic Simulator for Engineers) is a sophisticated sound system design tool and acoustic simulation software package for Windows PCs, created by SDA (Software Design Ahmert GmbH, Berlin). It enables extremely accurate acoustic calculations to be realised both for indoor venues and outside spaces. In this way acoustic parameters and properties can be calculated for audience areas or even particular listener seats. EASE is particularly useful where a large number of speakers may be used, i.e. in concert halls, stadiums and public buildings.

The EASE application itself is comprehensive and can account for a wide range of surface properties, i.e. absorption and dispersion and also early reflections, directivity and phase characteristics. 3D acoustical models can be created for computing parameters such as RT (Reverb Time), IR (Impulse Response) and SPL (Sound Pressure Level) distribution for sound reinforcement and speech intelligibility.

There are a variety of module upgrades that enhance EASE's capabilities, such as AURA (Analysis Utility for Room Acoustics) which has become a standard for modelling spaces in three dimensions along with the VISION rendering engine. EASE VIEW loads OpenGL and Mapping files as used in the design.

EARS is an auralisation module that allows the determination of audio quality, and the comparison of old against new sound system installs, by locating sound sources in the virtual room, or open air space, using convolving and binaural techniques.

EASERA is used for evaluating and measuring the transmission properties of both spaces and electrical equipment.

Use of Turbosound EASE data

Turbosound provides pre-measured EASE data to aid sound system designers in making appropriate choices with the type and positioning of speakers in the required venue. The suitability of certain models can be assessed and the installation can be improved by adapting the frequency response consequently.

The speakers are measured from the centre of an entire globe with 5 degree resolution and third octave frequency resolution.

EASE data is available from our download FTP server at ftp://ftp.turbosound.com/tech_data

Technical Specifications

Model	TCS-C50T
Dimensions HxWxD	268mm (10.5") dia x 83mm (3.3") deep excl back box 268mm (10.5") dia x 219mm (8.6") deep incl back box
Net Weight	3.4kg (7.5lbs)
Components	1 x 5" (127mm) LF driver, 1 x 1" (25mm) HF tweeter
Frequency Response ±4dB	75Hz - 22kHz
Nominal Dispersion	180°H x 180°V @ -6dB points
Power Handling	75 watts r.m.s., 150 watts program
Sensitivity 1 watt @ 1 metre	92dB (half space), 90 dB (full space)
Maximum SPL continuous-> peak->	110dB 116dB
Line transformer taps	60 watts, 30 watts, 15 watts (100 volt line) 60 watts, 30 watts, 15 watts, 7.5 watts (70 volt line)
Impedance	16 ohms nominal
Construction	Paintable injection moulded ABS plastic
Grille	Powder coated perforated steel
Connectors	Phoenix 4-way connector for input and link
Protection	Thermal fuse disconnects speaker from distributed system
Standards	Conforms to BS5839 part 8 1988 and IEC/EN 60849 fire prevention
Options	Without back can (TCS-C50TS) without back can or transformer (TCS-C50S)

Notes:

1. Frequency response is measured on axis
2. Nominal Dispersion and sensitivity are an average over stated bandwidth
3. Maximum continuous SPL is measured by using unweighted diode-clipped pink noise in a half space environment.
4. Maximum peak SPL is verified by subjective listening tests of familiar program material, before the onset of perceived signal degradation

NB: Due to continuing product improvement these specifications are subject to change.

Spares List

Spares	
LF Driver	LS-50 5" loudspeaker
HF Tweeter	TW-52 tweeter
Passive Crossover Network	PX-TCS-C50T
Grille	MG-C50
Tile bridge	TCS-C50TB

Warranty

Limited Warranty

This Turbosound loudspeaker product is warranted to the original end-user purchaser and all subsequent owners for a period of two (2) years from the original date of purchase.

Warranty Coverage

Warranty coverage includes defects in materials and workmanship. It does not include:

- damage caused by accident, misuse, abuse, neglect or modification by any other person other than an authorised Turbosound representative,
- damage caused by overdriving, use with unsuitable amplifiers or amplifier failure,
- damage caused by failure to operate the product in accordance with the instructions contained in the user's manual,
- damage occurring during shipment in transit,
- claims based upon any misrepresentations by the seller,
- products which do not have the original components as specified in the product engineering information,
- products on which the serial number has been removed or defaced.

Shipping

Should any fault develop with a component of your Turbosound system, please return the product, freight pre-paid, in its original packing carton, along with proof of purchase such as the original bill of sale or receipted invoice, and a description of the suspected fault to:

Turbosound Ltd. (Att: Customer Service), Star Road, Partridge Green, West Sussex RH13 8RY, England, or your local authorised Turbosound representative.

The product serial number must be quoted in all correspondence relating to the claim. Insurance is recommended, as Turbosound or its representatives are not liable for loss or damage in transit. Turbosound will pay for return freight costs should repairs be covered under warranty.

Incidental and consequential damages

Turbosound's liability is limited to the repair or replacement, at our option, of any defective product, and shall not be liable for any incidental and consequential damages including, without limitation, injury to persons or property or loss of use.

Limitation of implied warranties

All implied warranties, including warranties of merchantability and fitness for a particular purpose, are limited in duration to the length of this warranty.

This warranty is in addition to, and in no way detracts from, your statutory rights as a consumer. No other warranty is expressed or implied.

Please record your purchase information below for future reference:

Dealer Name

Dealer Address

.....

.....

Post / Zip Code

Dealer telephone / fax

Invoice number

Date of purchase

Unit serial number

Notes

Free Manuals Download Website

<http://myh66.com>

<http://usermanuals.us>

<http://www.somanuals.com>

<http://www.4manuals.cc>

<http://www.manual-lib.com>

<http://www.404manual.com>

<http://www.luxmanual.com>

<http://aubethermostatmanual.com>

Golf course search by state

<http://golfingnear.com>

Email search by domain

<http://emailbydomain.com>

Auto manuals search

<http://auto.somanuals.com>

TV manuals search

<http://tv.somanuals.com>