



M/A-COM
P5300 Series
Portable Radio

MANUAL REVISION HISTORY

REV	DATE	REASON FOR REVISION
-	May/07	Initial release.
A	Jul/07	Added Lithium Ion battery pack tamper warning.

M/A-COM Technical Publications would particularly appreciate feedback on any errors found in this document and suggestions on how the document could be improved. Submit your comments and suggestions to:

Tyco Electronics Wireless Systems Segment

M/A-COM, Inc.

Technical Publications

221 Jefferson Ridge Parkway

Lynchburg, VA 24501

or

Fax your comments to: 1-434-455-6851

e-mail us at: techpubs@tycoelectronics.com

ACKNOWLEDGEMENTS

The software contained in this device is copyrighted by M/A-COM, Inc. Unpublished rights are reserved under the copyright laws of the United States.

This device is made under license under one or more of the following U.S. Patents: 4,590,473; 4,636,791; 5,148,482; 5,185,796; 5,271,017; 5,377,229; 4,716,407; 4,972,460; 5,502,767; 5,146,497; 5,164,986; 5,185,795.

CREDITS!

OpenSky and EDACS are registered trademarks of M/A-COM, Inc.

TORX is a registered trademark of CAMCAR division of TEXTRON, Inc.

All other product and brand names are trademarks, registered trademarks, or service marks of their respective holders.

NOTICE!

This manual covers M/A-COM products manufactured and sold by M/A-COM, Inc.



This product conforms to the European Union WEEE Directive 2002/96/EC. Do not dispose of this product in a public landfill. Take it to a recycling center at the end of its life.



The voice coding technology embodied in this product is protected by intellectual property rights including patent rights, copyrights, and trade secrets of Digital Voice Systems, Inc. The user of this technology is explicitly prohibited from attempting to decompile, reverse engineer, or disassemble the Object Code, or in any other way convert the Object Code into human-readable form.

Repairs to this equipment should be made only by an authorized service technician or facility designated by the supplier. Any repairs, alterations, or substitution of recommended parts made by the user to this equipment not approved by the manufacturer could void the user's authority to operate the equipment in addition to the manufacturer's warranty.

This manual is published by **M/A-COM, Inc.**, without any warranty. Improvements and changes to this manual necessitated by typographical errors, inaccuracies of current information, or improvements to programs and/or equipment, may be made by **M/A-COM, Inc.**, at any time and without notice. Such changes will be incorporated into new editions of this manual. No part of this manual may be reproduced or transmitted in any form or by any means, electronic or mechanical, including photocopying and recording, for any purpose, without the express written permission of **M/A-COM, Inc.**

TABLE OF CONTENTS

	<i>Page</i>
1 SAFETY CONVENTIONS.....	10
2 SAFETY TRAINING INFORMATION	11
2.1 RF EXPOSURE GUIDELINES	11
2.2 ELECTROMAGNETIC INTERFERENCE/COMPATIBILITY	12
3 OPERATING TIPS	13
3.1 EFFICIENT RADIO OPERATION	13
3.1.1 Antenna Care and Replacement.....	13
3.1.2 Electronic Devices	13
3.1.3 Aircraft.....	14
3.1.4 Electric Blasting Caps	14
3.1.5 Potentially Explosive Atmospheres	14
4 BATTERIES	15
4.1 CONDITIONING BATTERY PACKS.....	15
4.1.1 Conditioning NiMH Battery Packs.....	15
4.1.2 Conditioning NiCD Battery Packs.....	15
4.1.3 Additional Information.....	16
4.2 CHARGING BATTERY PACKS	16
4.2.1 Charging Guidelines	16
4.3 BATTERY PACK USAGE.....	16
4.3.1 Usage Guidelines	16
4.4 CHANGING THE BATTERY PACK	17
4.4.1 Removing the Battery Pack	17
4.4.2 Attaching the Battery Pack	18
4.5 BATTERY DISPOSAL.....	18
5 INTRODUCTION	20
5.1 WATER RESISTANCE.....	20
6 OPTIONS AND ACCESSORIES	21
7 USER INTERFACE	23
7.1 CONTROLS	24
7.1.1 Buttons and Knobs.....	24
7.1.2 Keypad.....	26
7.1.3 Display.....	28
7.1.4 Tri-Color LED	30
7.2 UNIVERSAL DEVICE CONNECTOR.....	30
8 OPENSKY OPERATION.....	32
8.1 CONTROLS	32
8.1.1 Buttons and Knobs.....	32
8.1.2 Keypad.....	32
8.2 RADIO STATUS ICONS.....	34
8.3 TRI-COLOR LED	35
8.4 LOG IN TO THE NETWORK.....	35
8.5 LOG OFF THE NETWORK	36
8.6 PERSONALITY	36
8.6.1 Profiles.....	36

TABLE OF CONTENTS

		<u>Page</u>
	8.6.2 Talk Groups	37
8.7	OPENSKY DISPLAY OVERVIEW	37
	8.7.1 Display's Top Line	37
	8.7.2 Display's Second Line	37
	8.7.3 Dwell Display	37
8.8	ALERT TONES	38
8.9	BASIC MENU STRUCTURE	39
8.10	KEYPAD FUNCTION COMMANDS (P5370 ONLY)	41
8.11	CHANGING THE ACTIVE PROFILE	41
8.12	CHANGING THE SELECTED TALK GROUP	41
8.13	ADJUSTING DISPLAY AND BUTTON BACKLIGHT BRIGHTNESS	41
8.14	STEALTH MODE	42
	8.14.1 Enabling Stealth Mode	42
	8.14.2 Disabling Stealth Mode	42
	8.14.3 Stealth Mode using A/B Switch	42
8.15	ADJUSTING SIDE TONE AUDIO LEVEL	42
8.16	CHANGE OPERATING MODE	43
8.17	RECEIVING AND TRANSMITTING VOICE CALLS	43
	8.17.1 Receiving a Voice Call	43
	8.17.2 Transmitting a Voice Call	43
8.18	ADJUSTING AUDIO TREBLE LEVEL	43
8.19	TALK GROUP LOCK OUT	43
	8.19.1 Lock Out a Talk Group	44
	8.19.2 Unlock a Talk Group	44
8.20	SCANNING	44
	8.20.1 Selecting Scan Modes	44
	8.20.2 Checking or Changing Active Scan Mode	45
	8.20.3 Scanning Priority	46
8.21	MAKING SELECTIVE CALLS	46
	8.21.1 Manually Dialing a Selective Call (P5370 Only)	47
	8.21.2 Selective Call Using Speed Dial	47
	8.21.3 Accepting a Selective Call	48
	8.21.4 Rejecting a Selective Call	48
	8.21.5 Terminating a Selective Call	48
8.22	SELECTIVE ALERTS	48
	8.22.1 Defining Messages	48
	8.22.2 Sending a Message	49
	8.22.3 Receiving a Message	49
	8.22.4 Deleting a Selective Alert Message	49
8.23	MAKING INTERCONNECT CALLS (P5370 ONLY)	50
8.24	EMERGENCY COMMUNICATIONS	50
	8.24.1 Declaring an Emergency Call or Alert	51
	8.24.2 Receiving an Emergency Call	51
	8.24.3 Dismissing an Emergency	51
	8.24.4 Clearing an Emergency Call or Alert	52
8.25	DYNAMIC REGROUPING	52
8.26	GPS COORDINATES	52

TABLE OF CONTENTS

		<i>Page</i>
9	EDACS OPERATION.....	54
9.1	TURNING ON THE RADIO	54
9.2	CONTROLS	54
	9.2.1 Buttons and Knobs.....	54
	9.2.2 Keypad.....	55
9.3	DISPLAY	57
9.4	RADIO STATUS ICONS.....	58
9.5	TRI-COLOR LED	59
9.6	STATUS MESSAGES	59
9.7	ERROR MESSAGES	60
9.8	ALERT TONES	61
9.9	SYSTEM SELECTION.....	61
9.10	GROUP/CHANNEL SELECTION.....	62
9.11	MODIFY SCAN LIST	62
	9.11.1 P5370 Model.....	62
	9.11.2 P5350 Model.....	62
9.12	BACKLIGHT ON/OFF.....	63
9.13	CONTRAST ADJUST	63
9.14	DECLARING AN EMERGENCY.....	63
9.15	LOCKING/UNLOCKING KEYPAD	63
9.16	HIGH/LOW POWER ADJUSTMENT	63
	9.16.1 Using the Menu Button.....	64
	9.16.2 Using the Pre-Programmed Option Button.....	64
9.17	MENU	64
	9.17.1 Menu Item Selection Process.....	64
9.18	DIGITAL VOICE OPERATION	67
	9.18.1 Clear Mode	67
	9.18.2 Digital Mode.....	67
9.19	SCANNING TRUNKED GROUPS	68
	9.19.1 Turning Scan On and Off	68
	9.19.2 Adding Groups to a Scan List.....	69
	9.19.3 Deleting Groups from a Scan List	70
	9.19.4 Nuisance Delete.....	70
9.20	SCANNING TRUNKED SYSTEMS.....	71
	9.20.1 Wide Area System Scanning	71
	9.20.2 Priority System Scan	71
	9.20.3 ProScan.....	71
9.21	EMERGENCY OPERATION.....	72
	9.21.1 Receiving an Emergency Call	72
	9.21.2 Declaring an Emergency Call.....	72
9.22	INDIVIDUAL CALLS.....	72
	9.22.1 Receiving and Responding to an Individual Call	72
	9.22.2 Sending an Individual Call	73
	9.22.3 Call Storage Lists.....	74
9.23	TELEPHONE INTERCONNECT CALLS	75
	9.23.1 Receiving a Telephone Interconnect Call.....	75
	9.23.2 Sending a Telephone Interconnect Call.....	75

TABLE OF CONTENTS

	<u>Page</u>
9.23.3 Dual-Tone Multi-Frequency: Overdial/Conventional Mode	76
9.24 PROGRAMMABLE ENTRIES	77
9.24.1 Pre-Storing Individual and Telephone Interconnect Calls from the Keypad.....	77
9.25 STATUS/MESSAGE OPERATION	78
9.25.1 Status Operation	78
9.25.2 Message Operation	79
9.26 DYNAMIC REGROUP OPERATION	79
9.26.1 Emergency Operation	79
9.27 MACRO KEY OPERATION	79
9.28 PORTABLE DATA.....	79
9.28.1 Displays	80
9.28.2 DATA OFF Operation.....	80
9.28.3 DATA ON Operation	80
9.28.4 Exiting Data Cells.....	80
9.28.5 Scan Lockout Mode.....	81
9.28.6 Data Lockout Mode	81
10 CONVENTIONAL OPERATION	84
10.1 CONTROLS	84
10.1.1 Buttons and Knobs.....	84
10.1.2 Keypad.....	85
10.2 DISPLAY	87
10.2.1 Radio Status Icons	87
10.3 TRI-COLOR LED	88
10.4 STATUS MESSAGES	89
10.4.1 Error Messages	89
10.5 ALERT TONES.....	89
10.6 TURNING ON THE RADIO	89
10.7 SYSTEM SELECTION.....	90
10.8 GROUP/CHANNEL SELECTION.....	90
10.9 MODIFY SCAN LIST	91
10.9.1 P5370 Model.....	91
10.9.2 P5350 Model.....	91
10.10 NUISANCE DELETE.....	91
10.11 BACKLIGHT ON/OFF	91
10.12 CONTRAST ADJUST	92
10.13 DECLARING AN EMERGENCY.....	92
10.14 LOCKING/UNLOCKING KEYPAD	92
10.15 HIGH/LOW POWER ADJUSTMENT	92
10.16 MENU	93
10.16.1 Menu Item Selection Process.....	93
10.17 DIGITAL VOICE OPERATION	96
10.17.1 Clear Mode	96
10.17.2 Digital Mode.....	96
10.18 RECEIVING A CALL	97
10.19 SENDING A CALL	97
11 TECHNICAL ASSISTANCE	100

TABLE OF CONTENTS

	<i>Page</i>
12 BASIC TROUBLESHOOTING	101
FIGURES	
Figure 4-1: Removing the Battery Pack.....	17
Figure 4-2: Attaching the Battery Pack.....	18
Figure 7-1: P5300 Portable Radio.....	23
Figure 7-2: Top View.....	24
Figure 7-3: Side View.....	24
Figure 7-4: P5350 “Scan” Radio Front Panel.....	26
Figure 7-5: P5370 “System” Model Front Panel.....	26
Figure 7-6: Sample Dwell Display OpenSky Mode.....	28
Figure 7-7: Full Cycle Battery Charge Indicator.....	29
Figure 7-8: Tri-Color LED.....	30
Figure 8-1: Full Cycle Battery Charge Indicator.....	34
Figure 8-2: Tri-Color LED.....	35
Figure 8-3: Personality Structure Example.....	37
Figure 9-1: P5350 “Scan” Radio Front Panel.....	55
Figure 9-2: P5370 “System” Radio Front Panel.....	56
Figure 9-3: Radio Display.....	57
Figure 9-4: Full Cycle Battery Charge Indicator.....	58
Figure 9-5: Tri-Color LED.....	59
Figure 9-6: Menu Display.....	64
Figure 9-7: Backlight Menu Item Selection Parameter.....	65
Figure 9-8: Backlight Menu Display.....	65
Figure 9-9: Calls Received Lists.....	73
Figure 9-10: WHC Individual Call Display.....	73
Figure 9-11: Calls Received and Personality Lists.....	75
Figure 10-1: P5350 “Scan” Radio Front Panel.....	85
Figure 10-2: P5370 “System” Radio Front Panel.....	86
Figure 10-3: Radio Display.....	87
Figure 10-4: Battery Charge Icons (Full Cycle).....	88
Figure 10-5: Tri-Color LED.....	88
Figure 10-6: Menu Display.....	93
Figure 10-7: Backlight Menu Item Parameter.....	93
Figure 10-8: Backlight Menu Display.....	94
TABLES	
Table 2-1: RF Exposure Compliance Testing Distances.....	12
Table 6-1: Options and Accessories.....	21
Table 7-1: P5300 Front Keypad Functions.....	27
Table 7-2: Status Icons Descriptions.....	28
Table 8-1: Keypad Functions.....	33
Table 8-2: Status Icons Descriptions.....	34
Table 8-3: Alert Tones.....	38
Table 8-4: Basic P5300 OpenSky Menu Structure.....	39
Table 8-5: Keypad Function Commands.....	41
Table 8-6: Scan Modes.....	45
Table 8-7: Status of Selective Alert Messages.....	48

TABLE OF CONTENTS

	<u>Page</u>
Table 8-8: Emergency Calls vs. Emergency Alerts	50
Table 9-1: P5300 Keypad Functions.....	55
Table 9-2: Display Descriptions	58
Table 9-3: Alert Tones	61
Table 9-4: Menu Item Information	66
Table 9-5: Information Display.....	67
Table 9-6: Transmit/Receive Mode Compatibility for Digital Voice Operation	68
Table 10-1: Display Descriptions	87
Table 10-2: Alert Tones	89
Table 10-3: Menu Item Information	95
Table 10-4: Information Display.....	96
Table 10-5: Transmit/Receive Mode Compatibility for Digital Voice Operation	97
Table 12-1: Troubleshooting.....	101

SAFETY SECTION

1 SAFETY CONVENTIONS

The following conventions are used throughout this manual to alert the user to general safety precautions that must be observed during all phases of operation, service, and repair of this product. Failure to comply with these precautions or with specific warning elsewhere in this manual violates safety standards of design, manufacture, and intended use of the product. M/A-COM, Inc. assumes no liability for the customer's failure to comply with these standards.



The **WARNING** symbol calls attention to a procedure, practice, or the like, which, if not correctly performed or adhered to, could result in personal injury. Do not proceed beyond a **WARNING** symbol until the conditions identified are fully understood or met.



The **CAUTION** symbol calls attention to an operating procedure, practice, or the like, which, if not performed correctly or adhered to, could result in damage to the equipment or severely degrade the equipment performance.



The **NOTE** symbol calls attention to supplemental information, which may improve system performance or clarify a process or procedure.



The **ESD** symbol calls attention to procedures, practices, or the like, which could expose equipment to the effects of Electro-Static Discharge. Proper precautions must be taken to prevent ESD when handling circuit modules.



WARNING - The electrical hazard symbol indicates there is an electrical hazard present.

2 SAFETY TRAINING INFORMATION



WARNING

The M/A-COM P5300 portable radio generates RF electromagnetic energy during transmit mode. This radio is designed for and classified as “Occupational Use Only,” meaning it must be used only during the course of employment by individuals aware of the hazards and the ways to minimize such hazards. This radio is NOT intended for use by the “General Population” in an uncontrolled environment.

The P5300 portable radio has been tested and complies with the FCC RF exposure limits for “Occupational Use Only.” In addition, this M/A-COM radio complies with the following Standards and Guidelines with regard to RF energy and electromagnetic energy levels and evaluation of such levels for exposure to humans:

- FCC OET Bulletin 65 Edition 97-01 Supplement C, Evaluating Compliance with FCC Guidelines for Human Exposure to Radio Frequency Electromagnetic Fields.
- American National Standards Institute (C95.1 – 1992), IEEE Standard for Safety Levels with Respect to Human Exposure to Radio Frequency Electromagnetic Fields, 3 kHz to 300 GHz.
- American National Standards Institute (C95.3 – 1992), IEEE Recommended Practice for the Measurement of Potentially Hazardous Electromagnetic Fields – RF and Microwave.

2.1 RF EXPOSURE GUIDELINES



CAUTION

To ensure that exposure to RF electromagnetic energy is within the FCC allowable limits for occupational use, always adhere to the following guidelines:

- DO NOT operate the radio without a proper antenna attached, as this may damage the radio and may also cause the FCC RF exposure limits to be exceeded. A proper antenna is the antenna supplied with this radio by M/A-COM or an antenna specifically authorized by M/A-COM for use with this radio. (Refer to Table 6-1.)
- DO NOT transmit for more than 50% of total radio use time (“50% duty cycle”). Transmitting more than 50% of the time can cause FCC RF exposure compliance requirements to be exceeded. The radio is transmitting when the “TX” indicator appears in the display. The radio will transmit by pressing the “PTT” (Push-To-Talk) button.
- Always transmit using low power when possible. In addition to conserving battery charge, low power can reduce RF exposure.
- ALWAYS use M/A-COM authorized accessories (antennas, batteries, belt clips, speaker/mics, etc). Use of unauthorized accessories may cause the FCC Occupational/Controlled Exposure RF compliance requirements to be exceeded. (Refer to Table 2-1.)

- As noted in Table 2-1, ALWAYS keep the device and its antenna **AT LEAST** 2.8 cm (1.1 inch) from the body and at least 2.5 cm (1.0 inch) from the face when transmitting to ensure FCC RF exposure compliance requirements are not exceeded. However, to provide the best sound quality to the recipients of your transmission, M/A-COM recommends you hold the microphone at least 5 cm (2 inches) from mouth, and slightly off to one side.

Table 2-1: RF Exposure Compliance Testing Distances

RADIO FREQUENCY	TESTED DISTANCES (worst case scenario)	
	Body	Face
896-941MHz	2.8 cm	2.5 cm

The information in this section provides the information needed to make the user aware of RF exposure, and what to do to assure that this radio operates within the FCC RF exposure limits of this radio.

2.2 ELECTROMAGNETIC INTERFERENCE/COMPATIBILITY

During transmissions, this M/A-COM radio generates RF energy that can possibly cause interference with other devices or systems. To avoid such interference, turn off the radio in areas where signs are posted to do so. DO NOT operate the transmitter in areas that are sensitive to electromagnetic radiation such as hospitals, aircraft, and blasting sites.

3 OPERATING TIPS

Antenna location and condition are important when operating a portable radio. Operating the radio in low lying areas or terrain, under power lines or bridges, inside of a vehicle or in a metal framed building can severely reduce the range of the unit. Mountains can also reduce the range of the unit.

In areas where transmission or reception is poor, some improvement may be obtained by ensuring that the antenna is vertical. Moving a few yards in another direction or moving to a higher elevation may also improve communications. Vehicular operation can be aided with the use of an externally mounted antenna.

Battery condition is another important factor in the trouble free operation of a portable radio. Always properly charge the batteries.

3.1 EFFICIENT RADIO OPERATION

For optimum audio clarity at the receiving radio(s), hold the portable radio approximately two inches from your mouth and speak into the microphone at a normal voice level.

Keep the antenna in a vertical position when receiving or transmitting a message.

Do not hold the antenna when receiving a message and, especially, do not hold when transmitting a message.



Do NOT hold onto the antenna when the radio is powered on!

3.1.1 Antenna Care and Replacement



Do not use the portable radio with a damaged or missing antenna. A minor burn may result if a damaged antenna comes into contact with the skin. Replace a damaged antenna immediately. Operating a portable radio with the antenna missing could cause personal injury, damage the radio, and may violate FCC regulations.



Use only the supplied or approved antenna. Unauthorized antennas, modifications, or attachments could cause damage to the radio unit and may violate FCC regulations. (Refer to Table 6-1.)

3.1.2 Electronic Devices



RF energy from portable radios may affect some electronic equipment. Most modern electronic equipment in cars, hospitals, homes, etc. is shielded from RF energy. However, in areas in which you are instructed to turn off two-way radio equipment, always observe the rules. If in doubt, turn it off!

3.1.3 Aircraft



WARNING

- Always turn off a portable radio before boarding any aircraft!
- Use it on the ground only with crew permission.
- DO NOT use while in-flight!!

3.1.4 Electric Blasting Caps



WARNING

To prevent accidental detonation of electric blasting caps, DO NOT use two-way radios within 1000 feet of blasting operations. Always obey the "Turn Off Two-Way Radios" signs posted where electric blasting caps are being used. (OSHA Standard: 1926.900)

3.1.5 Potentially Explosive Atmospheres



WARNING

Areas with potentially explosive atmospheres are often, but not always, clearly marked. These may be fuelling areas, such as gas stations, fuel or chemical transfer or storage facilities, and areas where the air contains chemicals or particles, such as grain, dust, or metal powders.

Sparks in such areas could cause an explosion or fire resulting in bodily injury or even death.

Turn OFF two-way radios when in any area with a potentially explosive atmosphere. It is rare, but not impossible that a radio or its accessories could generate sparks.

4 BATTERIES

The P5300 series portable radios use rechargeable, recyclable Nickel Cadmium (NiCd), Nickel Metal Hydride (NiMH), or Lithium Ion (Li Ion) batteries. Please follow the directions below to maximize the useful life of each type of battery.



Do not disassemble or modify Lithium Ion battery packs. The Lithium Ion battery packs are equipped with built-in safety and protection features. Should these features be disabled or tampered with in any way, the battery pack can leak acid, overheat, emit smoke, burst, and/or, ignite.



If the battery is ruptured or is leaking electrolyte that results in skin or eye contact with the electrolyte, immediately flush the affected area with water. If the battery electrolyte gets in the eyes, flush with water for 15 minutes and consult a physician immediately.

4.1 CONDITIONING BATTERY PACKS

4.1.1 Conditioning NiMH Battery Packs

Condition a new NiMH battery before putting into use. This also applies to rechargeable NiMH batteries that have been stored for long periods (weeks, months, or longer). Conditioning requires fully charging and fully discharging the battery three (3) times using the tri-chemistry charger. The first time the battery is put into the charger, this unit will condition Nickel-based battery packs by automatically charging and discharging (cycling) the battery. Refer to the appropriate charger manual for details.



Failure to properly condition NiMH battery packs before initial use will result in shortened performance by the battery.

4.1.2 Conditioning NiCD Battery Packs

A new NiCD battery does not require conditioning before use. However, M/A-COM recommends periodically conditioning NiCD batteries to avoid the memory effect which results when a NiCD battery is repeatedly charged and not fully discharged, further resulting in a lower voltage and a lower capacity. Fortunately, both nominal voltage and capacity are restored through battery conditioning.

Conditioning requires fully charging and fully discharging the battery three (3) times using the tri-chemistry charger. The first time the battery is put into the charger, this unit will condition Nickel-based battery packs by automatically charging and discharging (cycling) the battery. Refer to the appropriate charger manual for details.



Always use M/A-COM authorized chargers and conditioners. Use of unauthorized chargers and conditioners may void the warranty.

4.1.3 Additional Information

For more information regarding the proper care of portable radio batteries or establishing a battery maintenance program, refer to ECR-7367 which may be ordered by calling toll free 1-800-368-3277, then select option 7.

4.2 CHARGING BATTERY PACKS

Battery chargers are available from M/A-COM with nominal charge times. Combinations include single and multi-position charge units.

M/A-COM chargers are specifically designed for charging nickel-based and lithium ion battery packs. The chargers are chemistry-specific for the battery packs and automatically adjust the charging profiles accordingly. Refer to the appropriate charger manual for specific operating instructions.

4.2.1 Charging Guidelines

Observe the following guidelines when charging a battery pack:

- Avoid high temperature during charging.
- Discontinue use if the charger is overheating.
- Only charge M/A-COM battery packs using a charger approved for use by M/A-COM.
- Do not leave batteries in the charger indefinitely. For best results leave the battery in the charger for two to six hours after the Green Ready LED comes on. Then place the battery pack into service and fully discharge (as indicated by the radio low battery warning) before re-charging.

If any faults are encountered while charging the battery pack, consult the charger's manual to determine the cause and possible corrective action.

4.3 BATTERY PACK USAGE

Both Nickel-based and Lithium ion batteries vary in capacity and life cycle. For instance, NiCd batteries have a longer life cycle than NiMH batteries whereas NiMH batteries have a larger capacity. However, both Nickel-based and Lithium ion type batteries require basic usage guidelines be followed in order to optimize the battery runtime or shift life.

4.3.1 Usage Guidelines

The following guidelines will help optimize the battery runtime or shift life:

- Ensure Nickel-based battery packs are fully discharged (as indicated by the radio low battery warning) before re-charging. Full discharge is not required for Lithium Ion battery packs.
- Periodically condition Nickel-based battery packs. The frequency should be determined based on usage patterns (refer to ECR-7367). If the battery is fully discharged (to radio Low Battery warning) during routine use, the frequency of conditioning may be reduced. Lithium Ion batteries do not suffer from memory-effect and therefore do not require conditioning.

Do NOT leave any M/A-COM rechargeable batteries in a charger for more than a few days.

4.4 CHANGING THE BATTERY PACK

4.4.1 Removing the Battery Pack

Make sure the power to the radio is turned OFF.



Although the P5300 has been designed to tolerate changing the battery pack without turning power off, M/A-COM, Inc. recommends turning the radio off before changing battery packs to ensure safety and best operation.

1. Press or pull both latches on either side of the battery pack ① toward the bottom of the radio simultaneously.
2. Pull the battery ② away from the radio.
3. Remove the battery pack from the radio.



Figure 4-1: Removing the Battery Pack

4.4.2 Attaching the Battery Pack

Make sure the power to the radio is turned OFF.

1. Align the tabs at each side on the bottom of the battery pack with the slots at the bottom of the battery cavity ①.
2. Push the top of the battery pack ② down until the latches click to attach the battery to the radio.
3. Tug gently to verify that the latches are secure and the battery pack is properly attached to the radio.



Figure 4-2: Attaching the Battery Pack

4.5 BATTERY DISPOSAL



In no instance should a battery be incinerated. Disposing of a battery by burning will cause an explosion.



RECHARGEABLE BATTERY PACK DISPOSAL – The product you have purchased contains a rechargeable battery. The battery is recyclable. At the end of its useful life, under various state and local laws, it may be illegal to dispose of this battery into the municipal waste stream. Check with your local solid waste officials for details in your area for recycling options or proper disposal. Canadian and U.S. users may call Toll Free 1-800-8-BATTERY® for information and/or procedures for returning rechargeable batteries in your locality.

PRODUCT INFORMATION

5 INTRODUCTION

The P5300 series portable radio is available in two models: the P5350 Scan model with a limited 6-button front-mounted keypad and the P5370 System model with a 15-button DTMF front-mounted keypad. The 900 MHz P5300 portable radio delivers end-to-end digital voice and IP data communications. It is designed to support multiple operating modes including:

- OpenSky[®] Trunked mode (OTP)
- EDACS[®] Trunked mode
- Conventional Analog mode

The P5300 portables can include all of these modes or just one. Additional modes of operation can be added with software updates.

The P5300 supports a full range of advanced digital trunking features, including voice group calls, priority scanning, emergency calls, late call entry, and dynamic reconfiguration. It performs autonomous roaming for wide area applications. High quality voice coding and robust audio components assure speech clarity.

In the trunked modes, the user selects a communications “operating” system (i.e., OpenSky or EDACS) and group. While communicating in a trunked mode, channel selection is transparent to the user and is controlled via digital communication with the system controller (e.g. base station in an OpenSky system or a CSD in an EDACS system). This provides advanced programmable features and fast access to communication channels.

In Conventional Analog mode, the user selects a channel and communicates directly on that channel. A channel is a transmit/receive radio frequency pair.

The exact operation of the radio will depend on the operating mode, the radio’s programming, and the particular radio system. Most features described in this manual can be enabled through programming. Consult your System Administrator for the particular features programmed into your P5300.

5.1 WATER RESISTANCE

The P5300 series portable radios operate reliably even under adverse conditions. These radios meet MIL-STD-810F specifications for wind driven rain, humidity, and salt fog.

6 OPTIONS AND ACCESSORIES

Table 6-1 lists the Options and Accessories tested for use with the P5300 series portable radios.

Refer to the maintenance manual or to M/A-COM's Products and Services Catalog for a complete list of options and accessories, including those items that do not adversely affect the RF energy exposure.



Always use M/A-COM authorized accessories (antennas, batteries, belt clips, speaker/mics, etc). Use of unauthorized accessories may cause the FCC Occupational/Controlled Exposure RF compliance requirements to be exceeded. (Refer to Table 2-1.)



Always use the correct options and accessories (battery, antenna, speaker/mic, etc.) for the radio. Immersion rated options must be used with an immersion rated radio. Intrinsically safe options must be used with intrinsically safe radios. (Refer to Table 6-1.)

Table 6-1: Options and Accessories

DESCRIPTION	PART NUMBER
ANTENNAS	
1/4-Wave Whip Antenna	KRE 101 1223/02
BATTERIES (IMMERSION-RATED)	
7.5V Nickel Cadmium (NiCd) Battery, Immersible, non-<IS>	BT-023406-001
7.5V Nickel Cadmium (NiCd) Battery, Immersible, <IS>	BT-023406-002
7.5V Nickel Metal Hydride (NiMH) Battery, Immersible, non-<IS>	BT-023406-003
7.5V Nickel Metal Hydride (NiMH) Battery, Immersible, <IS>	BT-023406-004
7.5V Lithium Ion (Li Ion) Battery, Immersible, non-<IS>	BT-023406-005
7.5V Lithium Ion (Li Ion) Battery, Immersible, <IS>	BT-023406-006
MISCELLANEOUS ACCESSORIES	
Speaker Mic without Antenna (cc) provision, <IS>	MC-023933-001
Speaker Mic with Antenna (cc) provision, <IS>	MC-023933-002
Earphone for Speaker Mic <IS>	LS103239V1
DROP SHIP AUDIO ACCESSORIES	
Earphone Kit, Black	EA-009580-001
Earphone Kit, Beige	EA-009580-002
2-Wire Kit, Palm Mic, Black	EA-009580-003
2-Wire Kit, Palm Mic, Beige	EA-009580-004
3-Wire Kit, Mini-Lapel Mic, Black	EA-009580-005
3-Wire Kit, Mini-Lapel Mic, Beige	EA-009580-006
Explorer Headset with PTT	EA-009580-007
Lightweight Headset Single Speaker with PTT	EA-009580-008
Breeze Headset with PTT	EA-009580-009
Headset, Heavy Duty, N/C Behind-the-Head, with PTT	EA-009580-010
Ranger Headset with PTT	EA-009580-011
Skull Mic with Body PTT and Earcup	EA-009580-012
Headset, Heavy Duty, N/C Over-the-Head, with PTT	EA-009580-013
Throat Mic with Acoustic Tube and Body PTT	EA-009580-014
Throat Mic with Acoustic Tube, Body PTT, and Ring PTT	EA-009580-015
Breeze Headset with PTT and Pigtail Jack	EA-009580-016

DESCRIPTION	PART NUMBER
Hurricane Headset with PTT	EA-009580-017
Hurricane Headset with PTT and Pigtail Jack	EA-009580-018
CARRYING CASE ACCESSORIES	
Leather Carrying Case without D-Rings Kit, consists of: Leather Case without D-rings Elastic Strap Swivel Mount, used with Belt Loop	Kit: CC-023931-003, incl: CC-023931-001 FM-011820 KRY 101 1608/2 used with: KRY 101 1609/1
Leather Carrying Case with D-Rings Kit, consists of: Leather Case with D-rings Elastic Strap Swivel Mount used with Belt Loop	Kit: CC-023931-004 CC-023931-002 FM-011820 KRY 101 1608/2 used with: KRY 101 1609/1
Leather Carrying Case with D-rings Elastic Strap and Shoulder Strap	CC-023931-002 FM-011820 CC103333V1
Swivel Mount and Belt Loop	KRY 101 1608/2 KRY 101 1609/1
Nylon Case (black) with Belt Loop	CC-023932-001 KRY 101 1609/1
Nylon Case (orange) with Belt Loop	CC-023932-002 KRY 101 1609/1
Metal Belt Clip (standard)	CC23894
Metal Belt Clip (alternate)	CC-011318
"T" Strap Holder	KRY 101 1656/1

7 USER INTERFACE

This section describes the primary user interface; the buttons, knob controls, indicators, and display.



Figure 7-1: P5300 Portable Radio

7.1 CONTROLS

7.1.1 Buttons and Knobs

The P5300 portable radios feature two rotary control knobs, an emergency button, and a dual-position A/B switch located on the top of the radio (Figure 7-2). The Push-To-Talk (PTT) button and two option buttons are located on the side (Figure 7-3).

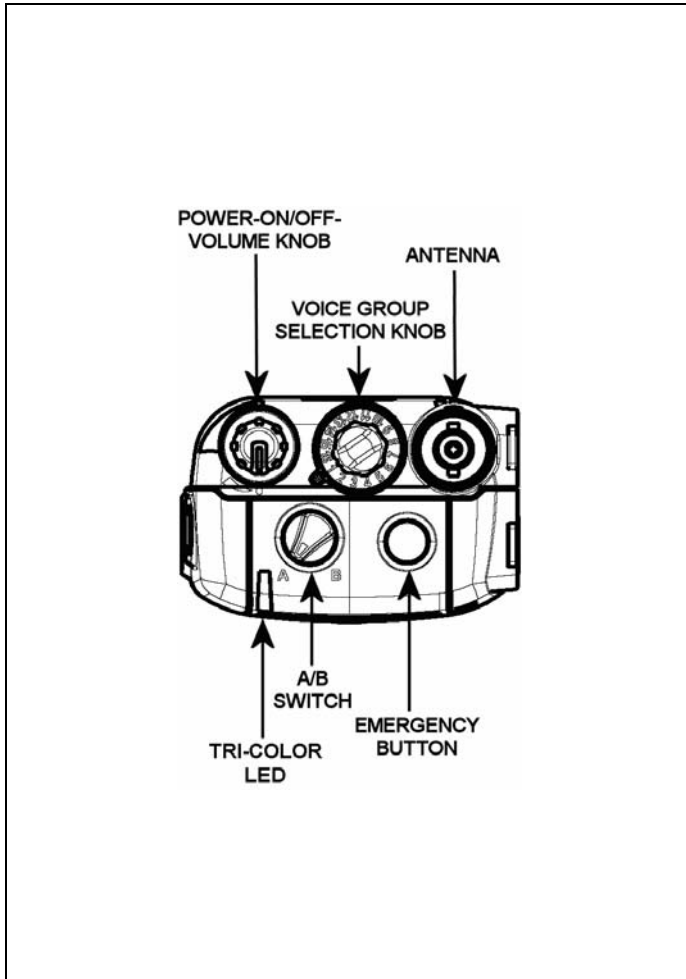

Figure 7-2: Top View

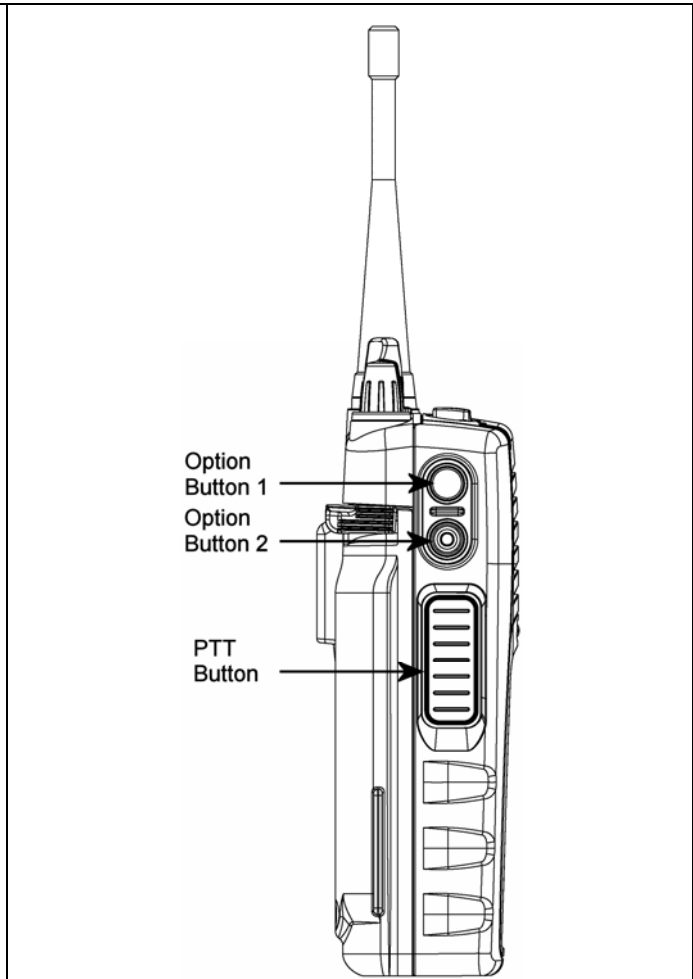

Figure 7-3: Side View

The functions of the button and knob controls vary depending on the mode of operation. The primary functions of the button and knob controls when in the OpenSky mode of operation are listed in the following paragraphs. The functions while in other modes are discussed in later sections.

POWER ON-OFF/VOLUME KNOB	Applies power to the radio and adjusts audio volume.
	Rotating the control clockwise applies power to the radio. A single alert tone (if enabled through programming) indicates the radio is operational.
	Rotating the control clockwise increases the volume level. Minimum volume levels may be programmed into the radio to prevent missed calls due to a low volume setting. While adjusting the volume the display will momentarily indicate the volume level (i.e. VOL=40). The volume range is from a minimum programmed level of zero (displayed as MUTE in the display) up to 40, which is the loudest level.
VOICE GROUP SELECTION KNOB	Used to select voice groups/channels. This is a 16-position rotary knob.
	<i>Note:</i> A mechanical stop, used to limit the number of accessible positions, is shipped with the radio but must be installed. To install the mechanical stop, remove the voice group selection knob, loosen the set screw on the voice group selection knob metal base (using a 1.27mm hex wrench), and remove the voice group selection knob metal base. Replace the 16 channel ring with the channel stop ring located at the desired channel. Re-install the voice group selection knob metal base, tighten the set screw, and re-install the voice group selection knob.
EMERGENCY BUTTON	Used to declare an emergency by pressing and holding for a programmed duration.
PTT BUTTON	The Push-To-Talk button must be pressed before voice transmission begins.
SIDE OPTION BUTTON 1 ○	Scrolls UP or DOWN thru available items within a sub-menu (available talk groups, pre-programmed speed dial numbers, canned alert messages, etc.).
SIDE OPTION BUTTON 2 ⊙	

7.1.2 Keypad

The front mounted keypad of the P5350 “Scan” model has six buttons and P5370 “System” model has 15 buttons. Refer to Figure 7-4: P5350 “Scan” Radio Front Panel and Figure 7-5: P5370 “System” Model Front Panel, respectively.

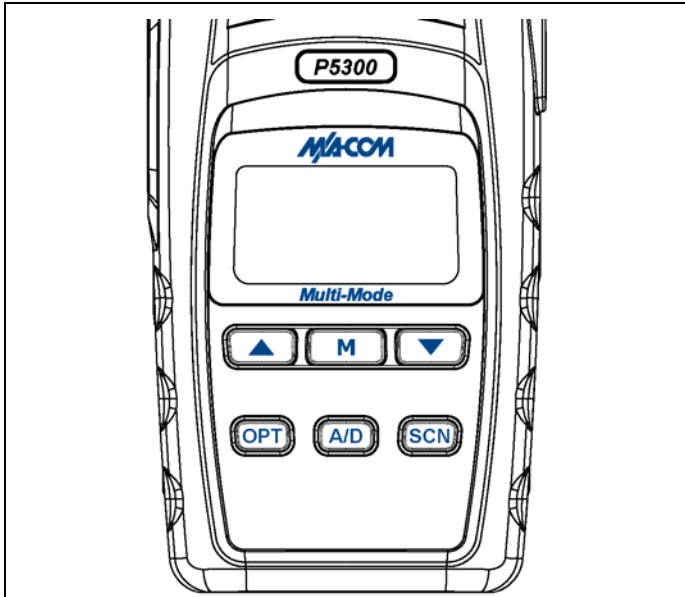

Figure 7-4: P5350 “Scan” Radio Front Panel



Figure 7-5: P5370 “System” Model Front Panel

























Alpha-numeric character entry is the function of most of the P5300 keypad keys in the OpenSky mode of operation. In addition, the  (*), and  (#) keys are also available. The function of each key is described in Table 7-1 and the following section.

Table 7-1: P5300 Front Keypad Functions

KEY	FUNCTION
	Primary function: Acts much as an “enter” button to activate a selection. Secondary function: While in the “dwell display,” press repeatedly to scroll through and view status display (on 2 nd line) for current profile, caller, received talk group, and channel.
 	Scrolls thru available menu items (see Table 8-4).
 (P5350 only)	In EDACS and Conventional Analog modes, Adds/Deletes selected groups or channels from SCAN list of the currently selected system. Currently undefined in OTP.
 (P5350 only)	In EDACS and Conventional Analog modes, toggles SCAN operation ON and OFF. Currently undefined in OTP.
 (P5350 only)	In EDACS and Conventional Analog modes, activates one of any programmable software options selected during the PC programming, including: high/low TX power and talkaround. Currently undefined in OTP.
            (P5370 Only)	These keys function much as a typical DTMF telephone pad 0-9, *, and # keys; and are used to place telephone interconnect and individual (unit-to-unit) calls. They can also be used to enter passwords for logging into the OpenSky network, if not pre-configured for automatic registration at power-up.
 (P5370 Only)	 Initiates OpenSky functions (log in, log out, selective call, telephone interconnect call, etc.). See page 41 for additional information. It is also used as an escape or to clear an entry (something like backspace, but it clears everything and not only the last digit/character).
 (P5370 Only)	 Used in conjunction with alpha-numeric keys for passwords and OpenSky functions. See page 41 for additional information.

7.1.3 Display

The P5300 display is made up of 3 lines. Lines 1 and 2 contain twelve alpha-numeric character blocks each. The 3rd line also contains twelve blocks, each used to display radio status icons. If programmed, the display backlighting will illuminate upon power up or when radio controls are operated. Specific display characteristics will be discussed in following sub-sections.

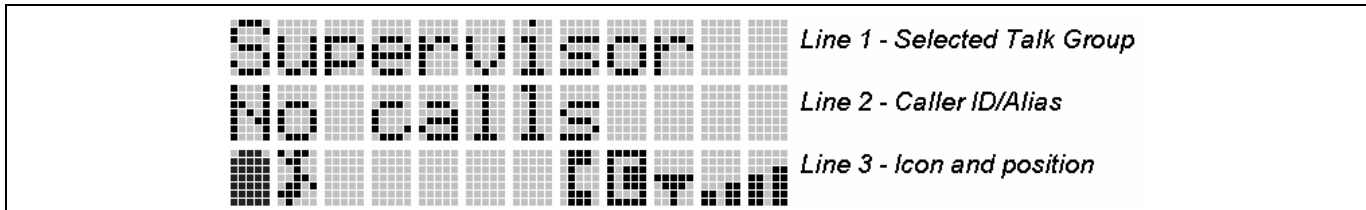











Figure 7-6: Sample Dwell Display OpenSky Mode

7.1.3.1 Radio Status Icons

Status Icons represent various operating characteristics of the radio and appear on the third line of the display. Each of the icons will be discussed in further detail in the corresponding modes of operation; OpenSky icons will be discussed in the OpenSky Operation sections and the EDACS and Conventional icons will be discussed in the EDACS or Conventional sections.

Table 7-2: Status Icons Descriptions

STATUS ICON DESCRIPTIONS	
OPENSKY ICONS	
	Steady – Battery charge indicator. Appears in the 1 st position in OpenSky mode, otherwise 12 th position.
	Flashing – Low battery indicator.
	Steady – Stealth mode is enabled, all tones and the display backlight are disabled, voice is still heard. Appears in the 2 nd position in OpenSky mode.
	Steady – Indicates Selective Call mode. Appears in the 8 th position in OpenSky mode.
	VTAC Connection Indicator – Indicates the client is connected to a VTAC. Appears in the 9 th position in OpenSky mode.
	Steady – Radio is data registered. Appears in the 10 th position in OpenSky mode.
	Steady – Indicates received signal strength. Appears in the 11 th and 12 th positions in OpenSky mode.
EDACS AND CONVENTIONAL ICONS	
	Steady – “Busy” transmitting or receiving. Appears in the 2 nd position of the display.
	Steady – special call mode (telephone). Appears in the 11 th position of the display.
	Steady – during all radio transmissions. Appears in the 1 st position of the display.

STATUS ICON DESCRIPTIONS	
	Steady – transmit at low power. Appears in the 5th position of the display. If icon is not visible – transmit at high power.
	Steady – battery charge indicator (refer to Figure 10-4). Appears in the 12th position of the display.
	Flashing – Low battery indicator (refer to Figure 10-4).
	Steady – Indicates the current channel is set up as an analog channel. Appears in the 7th position of the display.
	Steady – group or channel in scan list. Appears in the 10th position of the display.
	Steady – priority 2 group or channel. Appears in the 10th position of the display.
	Steady – priority 1 group or channel. Appears in the 10th position of the display.
	Steady (rotates clockwise) – scan mode enabled. Appears in the 9th position of the display. If icon is not visible – scan is disabled.
	Steady – Channel Guard enabled. Appears in the 4th position of the display. If icon is not visible – Channel Guard is disabled.
	Steady – Indicates the current channel is set up as a ProVoice or Aegis channel. Appears in the 7th position of the display.

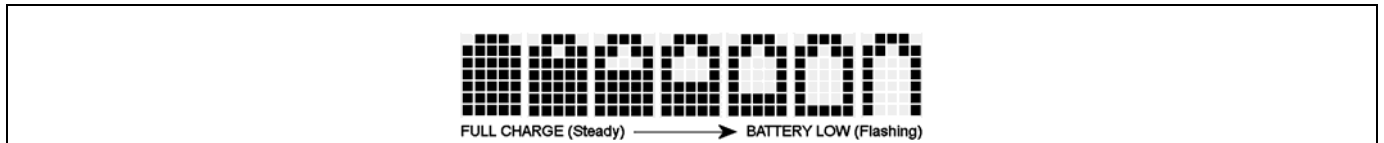

Figure 7-7: Full Cycle Battery Charge Indicator

The battery charge indicators illustrate approximate level only, based on battery voltage. Refer to Figure 8-1.

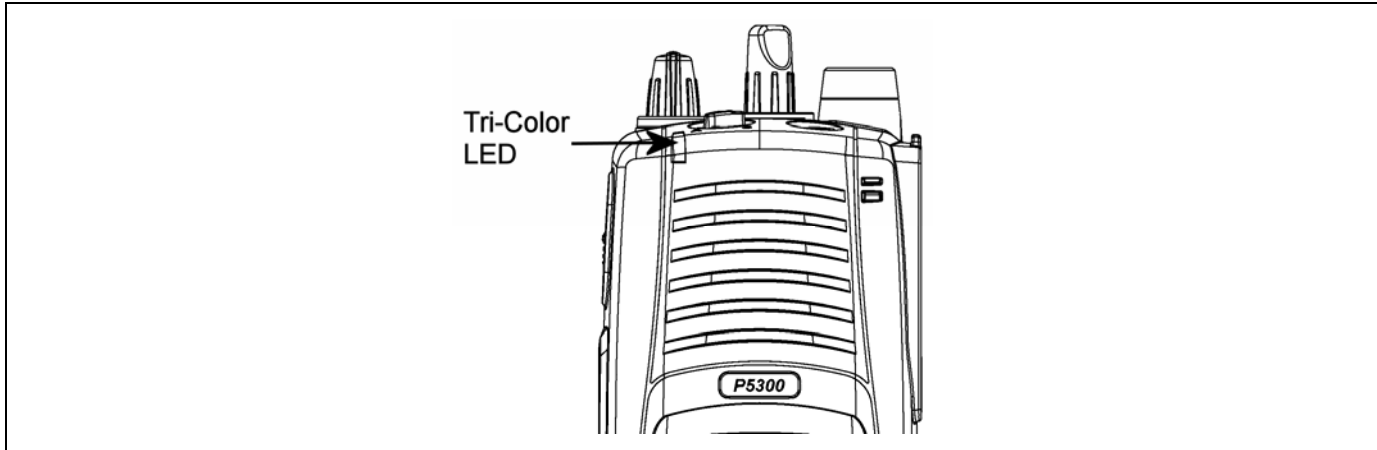

Figure 7-8: Tri-Color LED

7.1.4 Tri-Color LED

The Tri-Color LED changes color to indicate radio status and is visible from both the front and top of the radio (see Figure 8-2). In OpenSky mode only two radio states are reflected by the LED and the status they represent are:

- | | |
|--------|--------------|
| Green: | Receiving |
| Red: | Transmitting |

If the LED is flashing rapidly, the radio is receiving an emergency call. If the LED is flashing every ½ second, the selected talk group is in the emergency state (although not transmitting). If the selected talk group is in the emergency state, an asterisk will be displayed next to the talk group name.

7.2 UNIVERSAL DEVICE CONNECTOR

The Universal Device Connector (UDC) provides connections for external accessories such as a headset or a speaker-microphone and for programming cables. The UDC is located on the right side of the radio, opposite the PTT Button. The UDC facilitates programming and testing the radio. The UDC pins perform different functions depending on the accessory attached to the UDC.

OPENSKY OPERATION

8 OPENSKY OPERATION

Once an OpenSky system has been selected from the available systems on your P5300 series portable radio, the characteristics described in the following sections will govern operation.

8.1 CONTROLS

The P5300 portable radio features two rotary control knobs, an emergency button, and a dual-position A/B switch located on the top of the radio. Refer to Figure 7-2: Top View. The Push-To-Talk (PTT) button and two option buttons are located to the left side of the radio keypad, see Figure 7-3: Side View. The front mounted keypad of the P5370 “System” model has 15 buttons and the P5350 “Scan” model has six buttons. Refer to Figure 7-5 and Figure 7-4, respectively.

8.1.1 Buttons and Knobs

The function of the button and knob controls will vary depending on the mode of operation. The primary functions of the button and knob controls when in the OpenSky mode of operation are listed in the following paragraphs.

**POWER
ON-OFF
VOLUME KNOB**

Applies power to the radio and adjusts audio volume.

Rotating the control clockwise applies power to the radio. A single alert tone (if enabled through programming) indicates the radio is operational.

Rotating the control clockwise increases the volume level. While adjusting the volume the display will momentarily indicate the volume level (i.e. **VOL=31**). The volume range is from a minimum programmed level of zero (displayed as **MUTE** in the display) up to 40, which is the loudest level.

**VOICE GROUP
SELECTION
KNOB**

Used to select voice groups when operating within an OpenSky system. This is a 16-position rotary knob.

A mechanical stop, which can limit the number of positions accessed, is shipped with the radio but must be installed. To install the mechanical stop, remove the voice group selection knob, loosen the set screw on the voice group selection knob metal base (using a 1.27mm hex wrench), and remove the voice group selection knob metal base. Replace the 16 channel ring with the channel stop ring located at the desired channel. Re-install the voice group selection knob metal base, tighten the set screw, and re-install the voice group selection knob.

**EMERGENCY
BUTTON**

Press to declare an emergency. Press and hold for three seconds to clear emergency.

PTT BUTTON

The Push-To-Talk button must be pressed before voice transmission begins.

**SIDE OPTION
BUTTON 1 ○**























Scrolls UP or DOWN thru available items within a sub-menu, such as available talk groups, pre-programmed speed dial numbers, canned alert messages, etc.

**SIDE OPTION
BUTTON 2 ◎**

8.1.2 Keypad

The keys on the keypad have special functions and are labeled using a symbol or abbreviated word describing its primary function. Numeric entry is a secondary function of the keys. Each key is described in Table 8-1.

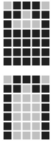





Table 8-1: Keypad Functions

KEY	FUNCTION
	Primary function: Acts much as an “enter” button to activate a selection. Secondary function: While in the “dwell display,” press repeatedly to scroll through and view status display (on 2 nd line) for current profile, caller, received talk group, and channel.
 	Scrolls thru available menu items (see Table 8-4).
 (P5350 only)	Currently undefined.
 (P5350 only)	Currently undefined.
 (P5350 only)	Currently undefined.
            (P5370 Only)	The alpha-numeric keys are used to place telephone interconnect and individual (unit-to-unit) calls. The keys operate like a normal telephone keypad. Also used to enter passwords for logging into the OpenSky network, if not pre-configured for automatic registration at power-up.
 (P5370 Only)	 Initiates OpenSky functions (log in, log out, selective call, telephone interconnect call, etc.). See page 41 for additional information. It is also used as an escape or to clear an entry (something like backspace, but it clears everything and not only the last digit/character).
 (P5370 Only)	 Used in conjunction with alpha-numeric keys for passwords and OpenSky functions. See page 41 for additional information.

8.2 RADIO STATUS ICONS

Status Icons indicate the various operating characteristics of the radio. The icons show operating modes and conditions and appear on the third line of the display (see Table 8-2).

Table 8-2: Status Icons Descriptions

	<p>Steady – Battery charge indicator. Appears in the 1st position in OpenSky mode.</p> <p>Flashing – Low battery indicator.</p>
	<p>Steady – Stealth mode is enabled, all tones and the display backlight are disabled, voice is still heard. Appears in the 2nd position in OpenSky mode.</p>
	<p>Steady – Indicates Selective Call mode. Appears in the 8th position in OpenSky mode.</p>
	<p>VTAC Connection Indicator – Indicates the client is connected to a VTAC. Appears in the 9th position in OpenSky mode.</p>
	<p>Steady – Radio is data registered. Appears in the 10th position in OpenSky mode.</p>
	<p>Steady – Indicates received signal strength. Appears in the 11th and 12th positions in OpenSky mode.</p>

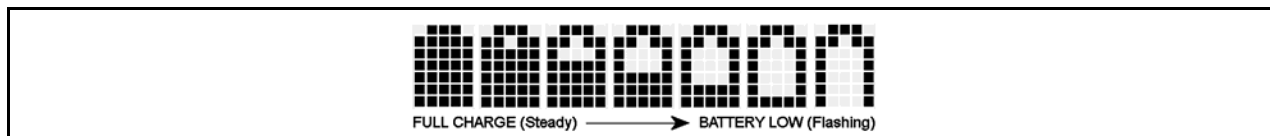

Figure 8-1: Full Cycle Battery Charge Indicator

The battery charge indicators illustrate approximate level only, based on battery voltage. Refer to Figure 8-1.

8.3 TRI-COLOR LED

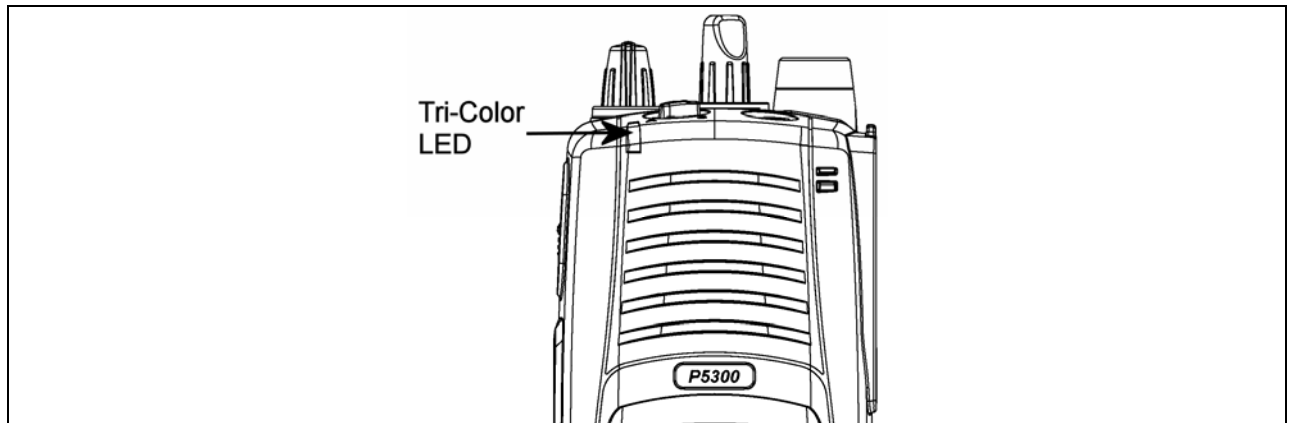

Figure 8-2: Tri-Color LED

The Tri-Color LED changes color to indicate radio status and is visible from both the front and top of the radio (see Figure 8-2). In OpenSky mode only two radio states are reflected by the LED and the status they represent are:







Green:	Receiving
Red:	Transmitting

If the LED is flashing rapidly, the radio is receiving an emergency call. If the LED is flashing every ½ second, the selected talk group is in the emergency state (although not transmitting). If the selected talk group is in the emergency state, an asterisk will be displayed next to the talk group name.

8.4 LOG IN TO THE NETWORK

Login occurs either automatically (auto registration) if the radio has a valid registration or, if enabled, requires the user to enter a User ID and password.

The user will be prompted to “Pls Login” with the *1 login command, a User ID, and password.

1. Press *1,   keys (Login command).
2. Enter the full 10-digit User ID.
3. Press the  key.
4. Enter the password.
 - If the radio is configured for alpha-numeric passwords and the password has consecutive duplicate numbers (“MES33” for example), enter #, the  key, between the consecutive duplicate numbers so the radio will **not** interpret the entry as a letter (“D” in this example).
 - If the radio is configured for numeric-only passwords, do not press the  key between duplicated numbers.
5. Press the  key twice.

The User ID may be remembered from the previous log-in. (Refer to Section 8.5 for further details regarding log-off commands.) The password will be established before the radio is put into operation. Contact the local OpenSky network administrator for more information.



If necessary, contact radio system administration personnel for log-in assistance and/or radio-specific log-in instructions.

8.5 LOG OFF THE NETWORK

The *0## command de-registers the radio. Typically, this is automatically performed when powering down the radio. Using this method, the User ID is remembered by the radio so only the password is needed at next log-in. Log-off manually by pressing .

If a user is logged in, it is necessary to log-off.

8.6 PERSONALITY

As illustrated in Figure 8-3, a personality defines the profiles and talk groups available to the user. It is the structuring of a collection of profiles and privileges established by the OpenSky network administrator to provide the user with a comprehensive set of profiles to communicate effectively with the necessary talk groups or individuals.

Personalities are stored on the network and downloaded over-the-air to the radio. This process is called “provisioning.” Provisioning occurs at radio power-up (if the personality is not already stored in the radio’s memory) and at user log-in. When changes are made to the personality, the radio is automatically re-provisioned. Each personality can contain up to sixteen (16) profiles and each profile can contain up to sixteen talk groups.

8.6.1 Profiles

As stated above, each profile can contain up to sixteen (16) talk groups. A profile also defines the radio’s emergency behavior. All transmissions are made on the selected talk group (displayed on the top line of the dwell display). The user can change the selected talk group to any of the other talk groups within the profile.

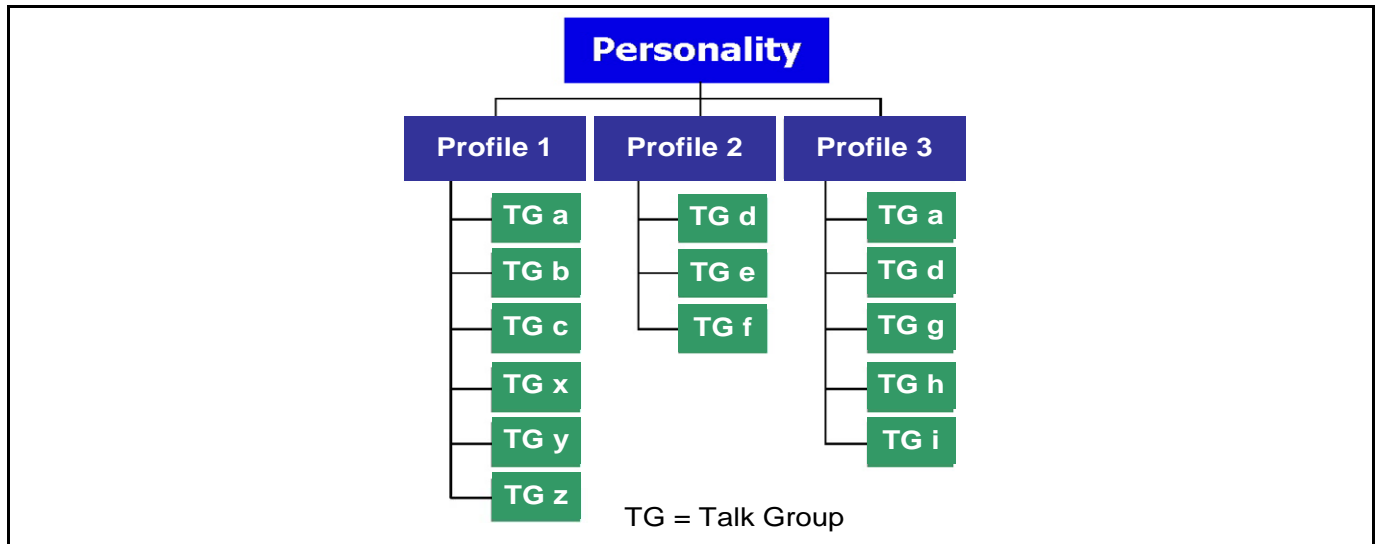

Figure 8-3: Personality Structure Example



8.6.2 Talk Groups

A talk group represents a set of users that regularly need to communicate with one another. There can be any number of authorized users assigned to a talk group. Talk groups are established and organized by the OpenSky network administrator. An OpenSky talk group is similar to a channel within a conventional FM radio system.

8.7 OPENSKY DISPLAY OVERVIEW

The 12-character x 3-line display shows the radio status. The first two lines of the display are text lines that change in response to user interaction with the menu buttons. Status icons appear in the bottom line (line 3) of the display (see Table 8-2).

8.7.1 Display's Top Line

The display's top line of text changes as the  and  buttons are pressed to scroll through the available menu options (see Table 8-4). When the dwell display is present, the selected talk group will be displayed. Other information, such as alert messages will scroll across the top line of the display.

8.7.2 Display's Second Line

The second line will display information such as active menu, login prompt, emergency status, and dwell display messages as described in the following section.

8.7.3 Dwell Display

When not engaged in menu selection, the first two lines of the display default to the user-defined display, known as the "dwell display." The top line indicates the currently selected talk group. The second line will display the currently selected profile, caller ID/alias¹, received talk group, and current channel name. Press the  button repeatedly to scroll through and view one of these second line options.

¹ Alias is a logical ID name such as "J_Smith." The name corresponds to a user ID such as 003-542-0001.

8.8 ALERT TONES

The P5300 radio also provides audible Alert Tones or “beeps” to indicate the various operating conditions (see Table 8-3).

Table 8-3: Alert Tones

NAME	STONE	DESCRIPTION
Call Queued	one low tone/two high tones	Call queued for processing
Call Denied	three short	Radio is out of coverage area or requested talk group is active.
Grant (or Go-Ahead)	single short beep	Sounded when resources become available for a call request placed in the queue (if enabled) upon channel access. If the radio roams to another site while transmitting, then it will auto rekey and begin transmitting on that tower. It gives a second grant tone to let the user know they have roamed.
Call Removed	single long low-pitched tone	Notifies the user access to the channel has been lost (out of coverage area or pre-empted by higher-priority call)
Low Battery	one low-pitched/one short mid-pitched	Low battery
Selective Alert Received	four short tones	Only played once to indicate a selective alert has been receive
Emergency Alert Tone	three (3) short beeps	Sounds when an emergency alert is declared
Emergency Cleared Tone	one long low-pitched tone	Sounds when an emergency is cleared
Selective Call Ring Tone	a ringing tone similar to a telephone	Ringling is repeated every four (4) seconds until the call is accepted or rejected by the radio being called or until the network drops the call if unanswered after one (1) minute
Roam Tone	Two short tones, one high-pitched and one low-pitched	Sounds when the radio transitions from one radio base station site to another.

8.9 BASIC MENU STRUCTURE

Table 8-4 illustrates the basic P5300 OpenSky menu structure. Menu items will vary depending upon system programming, radio hardware, and optional configurations. All menus except the dwell display menu can be turned off by network administration personnel.

Table 8-4: Basic P5300 OpenSky Menu Structure

Menu Name	Radio Displays (first and second lines)	Usage Notes
	To/From Dwell Display ▼ ▲	
Engineering Display (Menu may not be available per programming.)	registration, RF sync and transceiver status codes bit-error rates and RSSI data	Displays radio system connection data. For engineering use.
Silent Emergency	▼ ▲ OFF/ON "SilentEmerg"	Use ○ or ⊕ to toggle between OFF/ON. Press M to enable.
Operating Mode (e.g., OTP, OCF)	▼ ▲ available modes "Mode Menu"	Use ○ or ⊕ to choose an available mode. Press M and confirm (Y/N) with ○ or ⊕ and M again.
GPS Fix (e.g., GPS, GPS (Site), GPS (Aged))	▼ ▲ current latitude and longitude (degrees:minutes:seconds) "GPS"	GPS latitude and longitude position of currently tuned-to base station ["GPS (Site)"] or V-TAC ("GPS") scrolls across top line of the display. "GPS (Aged)" indicates VTAC coordinates haven't been updated for more that 2 minutes.
User ID	▼ ▲ User ID # of user currently logged in "User ID"	User's identification/name scrolls across top line of the display (if programmed).
IP Address	▼ ▲ Radio's IP address "IP Address"	Radio's Internet Protocol (IP) address scrolls across top line of the display.
Station Identification	▼ ▲ station's call sign "Station ID"	Station's identification/name scrolls across top line of the display (if programmed).
Stealth Mode (display backlight is disabled)	▼ ▲ "OFF" "StealthMenu"	Use ○ or ⊕ to turn on. Press any button to turn it off.
Treble Level	▼ ▲ "LOW", "MEDIUM", "MEDHIGH", "HIGH" "Treble Menu"	Use ○ or ⊕ to choose speaker treble level. Press M to return to dwell display.
Display Brightness	▼ ▲ "<< >>" "Bright Menu"	Use ○ or ⊕ to brighten or dim backlighting. Press M to return to dwell display.
Side Tone Level	▼ ▲ "OFF", "LOW", "MED", HIGH" "Side Menu"	Use ○ or ⊕ to choose side tone level. Press M to return to dwell display.
	▼ ▲ See Next Page	

Menu Name	Radio Displays (first and second lines)	Usage Notes
	See Previous Page	
	▼ ▲	
Selected Channel (Menu may not be available per radio programming)	selected channel "ChannelMenu"	Displays the current channel. Press [M] to return to dwell display.
Scan Mode (e.g. Normal, No Scan, Fixed)	current scan mode "ScnModeMenu"	Use [O] or [C] to turn scan on and off. Press [M] to return to dwell display.
	▼ ▲	
Talk group Lock Out	talk group "<" "LockOutMenu"	Use [O] or [C] to choose a talk group for locking/unlocking. Press [M] to toggle "<" on (locked out) and off.
	▼ ▲	
Priority 2 Talk group	current priority talk group "Priority2"	Use [O] or [C] to choose Priority 2 talk group. Press [M] to return to dwell display.
	▼ ▲	
Priority 1 Talk group	current priority talk group "Priority1"	Use [O] or [C] to choose Priority 1 talk group. Press [M] to return to dwell display.
	▼ ▲	
Alerts Received	time/sender's name/ alias/message text "AlertsRcvd" or oldest message	"No alerts" or alert message text scrolls in display. Use [O] or [C] to view all messages.
	▼ ▲	
Alert Destination	current speed dial # "AlertDest"	Use [O] or [C] to choose a speed-dial number. Press [M] to go to the "Alert Msg" menu. Use [O] or [C] to scroll through "canned messages." Press [M] to send message and return to dwell display.
	▼ ▲	
Speed Dial	current speed dial # "SpeedDial"	Use [O] or [C] to choose a speed-dial number and press PTT to place call.
	▼ ▲	
Profile Selection	currently active profile "ProfileMenu"	Use [O] or [C] to choose an available profile. Press [M] to return to dwell display.
	▼ ▲	
Talk group Selection	selected talk group "TalkGrpMenu"	Use [O] or [C] to choose a talk group in current profile. Press [M] to return to dwell display.
	▼ ▲	
Emergency Dismiss	alert received "EmgDismiss"	Use [O] or [C] to choose emergency talk group. Press [M] to toggle "<" on (dismiss) and off.
	▼ ▲	
Dwell Display	selected talk group (bottom line option)	Press [M] to change bottom line option.
	Use ▼ and ▲ to scroll through menus.	

8.10 KEYPAD FUNCTION COMMANDS (P5370 ONLY)

To perform a command from the keypad, use the keypad commands in Table 8-5.

Table 8-5: Keypad Function Commands

*0	Log-off command: *0## (logs the user off the system). See Section 8.5 for additional information. Key presses:
*1	Log-in command: *1<User ID> # <Password> ## (required for encryption). See Section 8.2 for additional information. Key presses: <User ID> <Password>
*4	SOI Mode: User is prompted with a channel to communicate with using the default profile. Exit SOI Mode with *4# Key presses:
*7	Initiate Selective Alert command: *7<Target ID>#[Choose Message]#. See Section 8.22 for additional information. Exit SOI Mode with *4#. Command:
*8	Radio-to-Radio Call command: *8<Selective call number>#(PTT to dial). Command: <Selective call number> <i>then press PTT to dial</i>
*9	Public Switched Telephone Network (PSTN) Call command: *9 <telephone number>#(PTT to dial) See Section 8.23 for additional information. Command: <telephone number> <i>then press PTT to dial</i>
*32	Begin Manual Encryption command: *32<Pre-determined Encryption Key># 1 – 16 digit encryption key for 128 bit encryption; 17 – 32 digit encryption key for 256 bit encryption. Command: <pre-determined encryption key>
*33	End Manual Encryption command: *33 Command:
*61	Initiate XCOV Mode: Extended coverage for individual users.
*62	Initiate XCOV-TG Mode: Extended coverage for talk groups.
*60	Exit XCOV or XCOV-TG Mode: Returns to the normal mode.

8.11 CHANGING THE ACTIVE PROFILE

The radio can store up to sixteen (16) standard profiles, one of which is the currently active profile. To change the currently active profile:

1. Press the or buttons until “ProfileMenu” is displayed.
2. Use or to scroll through the list of available profiles.
3. Profile becomes active when selected for longer than 2 seconds, when the is pressed, or when the menu is changed using the or button. Press to activate the selected profile.

8.12 CHANGING THE SELECTED TALK GROUP

Each profile stored in the radio can have up to sixteen (16) talk groups. One talk group within the currently active profile is set as the “selected talk group.” To change the selected talk group, turn the Group Selection knob on top of the radio.

8.13 ADJUSTING DISPLAY AND BUTTON BACKLIGHT BRIGHTNESS





1. Press the or buttons until “Bright Menu” is displayed.
2. Use or to brighten or dim the display and button backlighting.

8.14 STEALTH MODE

For some users, it is important to be able to turn off the radio's display lights and side tones, but not the radio traffic. For example, in covert operations, lights and sounds could inadvertently expose an otherwise unobservable radio user. For this purpose, the radio has a Stealth feature that disables the radio display light, indicator light and audible side tones.

When stealth mode is on, the radio continues to scan the programmed list of talk groups and the user can key-up on the selected talk group.

8.14.1 Enabling Stealth Mode

Press the  or  buttons to scroll through menus until "StealthMenu" appears in the display. To immediately activate Stealth Mode press the  or  button once. This activates Stealth Mode, exits the Stealth Menu, and returns to the Dwell Display.

The display lights, indicator lights, and side tones are disabled. The stealth mode icon is displayed.

8.14.2 Disabling Stealth Mode

To re-enable all lighting, side tones and exit Stealth Mode, press any key other than PTT or Emergency. This returns to the Dwell Display.

The display lights, indicator lights, and side tones are re-enabled. The stealth mode icon disappears.

8.14.3 Stealth Mode using A/B Switch

It is also possible to enable and disable Stealth Mode using the A/B Switch, if so programmed. Depending on programming the switch in one position will enable Stealth Mode and in the other position, disables it.



With stealth mode on, pressing any radio button (other than the mic's PTT button or the emergency button) on front panel will immediately turn stealth mode off. For example, pressing the  button on the front panel will turn stealth mode off.





8.15 ADJUSTING SIDE TONE AUDIO LEVEL

The radio sounds confirming tones called "side tones" when its buttons are pressed. Most users find this audible confirmation helpful when navigating the menus. Side tone audio level can be adjusted or turned completely off using the "Side Menu."









For covert operations, it may be necessary to turn off side tones. For safety's sake, turning off the radio during covert operations is not recommended.

If the radio is operating properly but side tones are not heard when the menu buttons are pressed, the side tones are probably turned off. To turn them back on, access the "Side Tone" menu and select a setting other than "off."

Use the following procedure set side tone level:

1. Press the  or  buttons to cycle through the menu until "Side Menu" is displayed.
2. Press  or  to change to the desired level (Off, Low, Medium, and High). To turn side tones completely off, use the "Off" setting.

8.16 CHANGE OPERATING MODE

1. Press the  or  buttons to cycle through the menu until “Mode Menu” is displayed.
2. Press  or  to select the desired operating mode.
3. Press  and use  or  to select Y or N.
4. Press  again to make selection and return to the dwell display

8.17 RECEIVING AND TRANSMITTING VOICE CALLS

As soon as the radio completes the initialization sequence and registers on the OpenSky network, the user will begin to hear calls from the talk groups in the active profile, if available.

8.17.1 Receiving a Voice Call

No action is required on the part of the user.





The caller’s alias is only shown when the selected talk group matches the received talk group. Otherwise, the name of the received talk group is displayed.

8.17.2 Transmitting a Voice Call

1. Select the desired talk group.
2. Depress and hold the **PTT** button, wait a couple of seconds. If programmed by the administrator, a grant tone will be sounded.
3. Begin speaking into the microphone in a normal voice.
4. For maximum clarity, hold the radio approximately 2 inches from your mouth. Take care not to cover up the microphone while speaking.
5. Release the **PTT** button to terminate an outgoing voice call.

8.18 ADJUSTING AUDIO TREBLE LEVEL

The tone of received signals can be adjusted using the radio’s “Treble Menu.”

1. Press the  or  buttons to cycle through the menu until “Treble Menu” is displayed.
2. Press  or  to increase or decrease level. There are four levels available: low, medium, medium-high, and high.
3. Press  or wait a few seconds to return to the dwell display.

8.19 TALK GROUP LOCK OUT

There are two ways to focus voice communications by suppressing calls from talk groups in the active profile.

- **No Scan.** By changing the Scanning Mode to “No Scan” only the selected talk group is scanned.
- **Lock Out.** By locking out selected talk groups, background noise or chatter can be eliminated and scanning resources can be focused on just those groups whose calls you wish to monitor.



Lock out is a listening (receive) function and only blocks received calls on locked out talk groups. Lock out does not affect transmit capability. “No Scan” and “Lock Out” do not apply to recent emergency lock outs.





Only talk groups in the active profile can be locked out, since they are the only talk groups whose voice calls can be heard on the radio. Talk group lock out is a scan-related feature. With lock out, one or more talk groups in the active profile can be temporarily disabled from being scanned. Calls are not received on locked-out talk groups. Lock out settings are not retained between profile changes or when the radio is power cycled.







If the Scan Mode is “Fixed,” P1 and P2 groups CANNOT be locked out. See Section 8.20 for more information.

The default emergency and emergency-capable talk groups can be locked out if they are NOT in an emergency state. If a talk group is locked out and is subsequently changed to the currently selected talk group, it will automatically be unlocked by the radio so the user can hear calls on the talk group. The radio may be configured so all talk groups are automatically locked out by default. In this case, they must be manually unlocked, if desired.

8.19.1 Lock Out a Talk Group

1. Use the  or  buttons to scroll through the menu choices until “LockOutMenu” appears in the display.
2. Use the  or  keys to scroll through the list of talk groups, if any, until the user group you want to lock out appears in the display.
3. Press the  key to select the lockable talk group.
4. “<” appears next to the locked out talk group.

8.19.2 Unlock a Talk Group

1. Use the  or  buttons to scroll through the menu choices until “LockOutMenu” appears in the display.
2. Use the  or  keys to scroll through the list of talk groups, if any, until the user group you want to unlock appears in the display.
3. Use the  key to unlock the displayed talk group.



- Changing the active profile removes any lockouts you have made.
- Turning off the radio removes any lockouts you have made.

8.20 SCANNING

8.20.1 Selecting Scan Modes

Three scanning modes are available for the radio, but only one can be active at any time. Changing the scanning mode changes the way the radio scans voice calls for all of the profiles in the radio personality, no matter which profile is or becomes active.

The choice of scanning mode broadens or narrows the span of communications with all the groups in profiles you listen to, but does not affect your interaction with those groups you talk with.

The scanning modes available for selection may be limited to a subset of the three scanning modes by the administrator.





Table 8-6: Scan Modes

SCAN MODE	EXPLANATION
No Scan	<p>Eliminates distractions. Full communications (listen and talk) with the active talk group. No calls received from other talk groups.</p>
Normal	<p>This is the default setting. The user can scan all talk groups in the active profile that are not locked out as long as there is demand on the site. Priority (P1 and P2) groups are user selectable. Receive calls from more than one talk group, if available from the current site. Allows dragging of the selected talk group, P1, P2, and default emergency talk groups to the site on which the radio is registered. (If other calls are available at the site, they also can be heard but they will not be actively dragged.) The default emergency talk group, as well as any emergency-enabled talk groups, is only dragged if it is in emergency mode.</p>
Fixed	<p>The priority groups are fixed to the selected profile's pre-defined P1 and P2 groups (configured via the UAS). In this mode, P1 and P2 groups CANNOT be locked out. The user can scan all talk groups in the active profile that are not locked out, as long as there is demand on the site. Allows dragging of the P1, P2, and selected talk group to the site on which the radio is registered. If other calls are available at the site, they can also be heard, but they will not be actively dragged. The default emergency talk group, as well as any emergency-enabled talk groups, is only dragged if in emergency mode.</p>

The scanning mode choice remains in effect until it is changed. Even if the radio is turned off, the current scanning mode selection is saved for the next use.

8.20.2 Checking or Changing Active Scan Mode

8.20.2.1 Setting the Scan Mode

1. Press the  or  buttons until "ScnModeMenu" appears in the display.
2. Use the  or  keys to scroll through the list of modes until your choice appears: Normal, None, or Fixed.
3. Press the  key to activate the scan mode selection and return to the dwell display.

8.20.2.2 Duration of Scanning Mode Selections





Scanning Mode selections survive power down. At startup, the radio defaults to the scanning mode of set during last use. The last selection made remains in effect until a new selection is made from the Scan Mode menu.

8.20.3 Scanning Priority

The following lists the scanning priority order (from highest to lowest):

- Selected talk group in emergency state.
- Default emergency group in emergency state.
- Selected talk group.
- Emergency capable group in emergency state
- Priority 1 talk group.
- Priority 2 talk group.
- Other (non-priority).

8.20.3.1 Changing Scan Priority

1. Press the  or  keys until “Priority1” or “Priority2” appears in the display (Priority1 group has higher priority than the Priority2 group).
2. Press the  or  button until the desired talk group is displayed.
3. Press the  key to select and activate the selection. The radio automatically returns to the Dwell Display.



NOTE

- Changing the priority of a listen group does not change your talk group.
- You set priority for two talk groups, but only in the selected profile.
- The scanning priority settings are reset to the default values when the radio is turned off.

8.21 MAKING SELECTIVE CALLS

Selective calling is the capability for two voice radio units to obtain and use an independent talk path for a unit-to-unit call. A properly equipped radio can initiate a selective call to any radio in the system that is also programmed for selective calls.

In the OpenSky system, a radio can be configured to initiate selective calls through a pre-programmed list in memory called a speed dial list. Alternatively, a properly equipped radio can initiate a selective call to any radio in the system by entering the ten-digit User ID (similar to a telephone number) of the target radio. Some radios are configured to only receive (not initiate) selective calls.



NOTE

Selective calls are terminated if an emergency is declared. The network limits selective calls to ten (10) minutes maximum.





If a Selective Call is attempted without registration, “No Priv” is displayed.

8.21.1 Manually Dialing a Selective Call (P5370 Only)

1. Enter *8, the User ID number of the user being called, and the # key (no dashes or spaces). *Note that this feature must be enabled by the administrator.*

*8<destination user id>#

  <destination user id> 

A shortened User ID number can be dialed using the following guidelines:

- If the radio being called is in the same region and agency – enter only the last four digits.
 - If the radio being called is in the same region, but a different agency – enter the last seven digits.
 - If the radio being called is in another region or if the area is unknown – enter all ten digits.
2. Press PTT (and release) to ring the other user.

The ring tone is sounded.





If the other user accepts the call, the called user’s alias will appear in initiating caller’s display. The two are now in a unit-to-unit call until one ends the call, the call is terminated due to an initiated emergency, or the maximum time limit of ten (10) minutes is reached.

If the called radio is busy, “BUSY” will appear in the second line of the display.

8.21.2 Selective Call Using Speed Dial



Speed dial numbers are defined and provisioned by the OpenSky network administrator and cannot be manually entered into the radio by the user. Contact the administrator if changes to the speed dial list are required.

1. Scroll through the Menu options using the  or  button until “Speed Dial” appears in the second line of the display. Using the  or  keys, scroll through the pre-programmed speed-dial numbers until the desired number appears in the display and press the PTT button.

OR

2. Press and hold a key associated with a given number for more than three seconds. For example, press and hold the  to open the Speed Dial Menu and display the number assigned to that key in the speed dial list. Press the PTT button.

A ring tone is sounded.

If the other user accepts the call, the called user’s alias will appear in initiating caller’s display. The two are now in a unit-to-unit call until one ends the call, or the call is terminated due to an initiated emergency.

If the called radio is involved in another selective call, “BUSY” will appear on the second line of the display. “Unavailable” is displayed when the call has not been answered after a 1 minute timeout or when the other party is not registered on the network.

8.21.3 Accepting a Selective Call

1. The radio will ring (like a telephone), indicating you are receiving a Selective Call.
2. Press the **O** button to accept the incoming selective call.
3. “CONNECT” will appear in the display, followed by “Lim 10 Min.” “SEL CALL” and the alias of the caller appear in the display once the call is established.

8.21.4 Rejecting a Selective Call

When a Selective Call is being received (the radio is ringing), you can reject the call by pressing either of the **▼** or **▲** buttons, the **⊖** button, or by turning the Voice Group Selector Control knob. The call will be rejected and “Reject” appears on the callers display.

8.21.5 Terminating a Selective Call

Terminate a Selective Call (call must be active) by pressing the **▼**, **▲**, **O**, **⊖**, **#NO**, or **M** buttons, or by turning the Voice Group Selector Control knob. “HANGUP” will appear in the display followed by the active talk group.

8.22 **SELECTIVE ALERTS**

Selective alert messaging is an OTP feature that allows one of up to eight (8) pre-programmed (canned) text messages to be sent from one radio to another. The sender specifies a destination (receiving) radio, selects one of the pre-programmed text messages, and then transmits it to the destination radio. The message delivery system adds sender and time-of-day information and forwards the message to the destination (receiving) radio. The sending radio receives a brief message noting the status of the transmission.

Received messages are stored in the radio until deleted or until the radio is rebooted. Received messages do not survive a reboot.

8.22.1 Defining Messages

All selective alert messages are pre-defined. The messages are programmed and provisioned remotely by your OpenSky system administrator. The radio user cannot create selective alert message content. The entire selective alert message, including the abbreviation, can be up to 200 characters long.

When sending a selective alert message, the radio may display one of the following status messages (Table 8-7).



Table 8-7: Status of Selective Alert Messages

STATUS MESSAGE	DEFINITION
Delivering	Select Alert message transmit attempt
Busy	Too busy – Try again
Dest Down	Receiving radio not logged on – Not registered
Not Reg	Transmitting radio not logged on – Not registered
Delivered	Transmission complete
Unreachable	No response
Partial	Transmission interrupted







8.22.2 Sending a Message

The sending process has three steps. First select the destination radio's User ID, then select the alert message, and finally send the message.









8.22.2.1 Selecting a Destination Using the Keypad (P5370 Only)

- Using the keypad, enter *7, the   keys.

At the "AlertDst" prompt, enter the full *User ID* of the unit to send the message. A shortened User ID number can be dialed using the following guidelines:

- If the radio being called is in the same region and agency – enter only the last four digits.
 - If the radio being called is in the same region, but a different agency – enter the last seven digits.
 - If the radio being called is in another region or if the area is unknown – enter all ten digits.
- Press the  key to activate the selection.
 - Use the  and  buttons or the  and  buttons to scroll through the available messages until the desired message is displayed.
 - Press the  or  key to send the message.
 - Observe Status Messages (Table 8-7) to ensure proper delivery.

8.22.2.2 Selecting a Destination Using the Menu





- Using the  or  key, scroll through the menu until "AlertDst" (Alert Destination) appears.
- Use the  or  button to scroll through the list of User IDs until the desired destination is displayed and press the  key.
- Use the  or  buttons to scroll through the available messages until the desired message is displayed.
- Press the  key to send the message.
- Observe Status Messages (Table 8-7) to ensure proper delivery.

8.22.3 Receiving a Message

When a selective alert message is received by a radio, a four-beep tone is heard. The tone is heard only once, but the message "NEWALRT" alternates with the talk group on the main display. Up to 8 received messages can be stored. If a ninth message is received, the first (oldest) message is automatically deleted to make room for the new message.

Received messages are displayed with the time and source information.

To display a Selective Alert Message:

- Using the  or  button, scroll through the menu items until "Alerts Rcvd" appears. The oldest message is displayed and scrolls across the top line of the display.
- The message includes the time, the User ID, and alias of the sender along with the message.
- To view the next message, press the  or  button to go forward or backwards.

8.22.4 Deleting a Selective Alert Message

- Display the message.

2. Press the **[M]** key and **[O]** or **[⊕]** to select Y or N.
3. At the “Delete? Y” prompt, press the **[M]** key. The message will be deleted.



Received messages cannot be saved.

8.23 MAKING INTERCONNECT CALLS (P5370 ONLY)

1. Using the keypad, enter *9, followed by the telephone number being called, and the # key (no dashes or spaces).

*9<telephone number>#

Wait a couple of seconds and press and release the PTT button to initiate the call. An initial ring tone will sound to indicate signal call initiation. Once the gateway picks up the call, the ring tone will change. Press and hold the PTT and talk normally then release the PTT to listen.

2. To hang up the call, press **[▼]**, **[▲]**, **[O]**, **[⊕]**, **#**, or **[M]**.

8.24 EMERGENCY COMMUNICATIONS

The P5300 portable radio is capable of sending an emergency alert and making emergency calls on the network. The OpenSky system handles emergency calls with the highest priority, allowing you or the people you serve to get needed help.

Emergency call and alert capability for a profile is configured by the system administrator.



The radio that initiates an *emergency alert* emits a signal of 3 distinct beeps that only goes to the dispatch console.

Table 8-8: Emergency Calls vs. Emergency Alerts

EMERGENCY ALERT	EMERGENCY CALL
<p>An Emergency Alert message is sent to the dispatcher console. The dispatch console plays an emergency tone when it receives the message.</p>	<p>An Emergency Alert message is sent to the dispatcher console. All peers (radios and consoles) and the dispatch console play the emergency tone whenever an emergency call is detected. An emergency tone plays for each new emergency, or when a profile is changed, (assuming there is an emergency on one of the talk groups for the new profile).</p> <p>If the orange LED is flashing rapidly, the radio is receiving an emergency call. If the LED is flashing every 1/2 second, the selected talk group is in the emergency state (although not transmitting). If the selected talk group is in the emergency state, an asterisk displays next to the talk group name.</p>

No emergency audio (voice) transmission (hot-mic) capability available (per programming by system administrator)	In addition to the Emergency Alert signal, the microphone goes hot for a predetermined length of time to allow for emergency audio (voice) transmission. The radio declaring the emergency has channel access priority. Note that the User can also use the PTT after the pre-determined hot-mic audio transmission, or during to extend the initial hot-mic audio transmission.
--	--

8.24.1 Declaring an Emergency Call or Alert

1. Press the red emergency button on the radio to enter emergency mode.



NOTE

The emergency behavior for the selected profile is configured by the network administrator. This determines whether pressing the Emergency button sends an Emergency Call or just an Emergency Alert. An Emergency Alert is always *part of* and *sent with* an Emergency Call.

If the active profile of the unit initiating the emergency is configured to Emergency Alert, the three-beep emergency alert signal is sent only to the dispatcher console.

If the active profile of the unit initiating the emergency is configured to Emergency Call, the three-beep emergency alert signal is sent to the dispatcher console and to all other radios within the selected talk group. The default emergency talk group becomes the selected talk group. The display will alternate between the emergency talk group name and “EMERGENCY” to indicate that the emergency has been initiated.

2. The microphone is hot (open mic) for a programmed amount of time in order to send your voice out on the emergency talk group.

All of the radios in the emergency talk group hear your call and see the emergency talk group displayed on their radio.

8.24.2 Receiving an Emergency Call

Initially, when receiving an emergency call, the radio sounds the emergency tone (three short high-pitched tones).

The radio will flash “EMERGENCY” and display the alias of the user that triggered the emergency or the alias of the talk group (if the incoming talk group is the selected talk group of the receiving radio).

With “No Scan,” only the emergency tone is heard, not the initial open mic transmission.

To dismiss or ignore the emergency, refer to Section 8.24.3.



8.24.3 Dismissing an Emergency

The “Dismissing an Emergency” function allows you to “ignore” an emergency declared by another user.



NOTE

An emergency is dismissed for a configurable amount of time (default = 5 minutes).

1. After receiving an emergency call, press the  or  button until you see “EmgDismiss.”
2. Press the  to toggle “<” on (dismiss) and off. This works in similar fashion to the lock out menu.



The emergency dismiss timer is cleared when the emergency is cleared.

8.24.4 Clearing an Emergency Call or Alert

1. When the emergency ends, press and hold the red emergency button for three to five seconds to clear the emergency alert and call while on the active emergency talk group. The remove tone sounds when the emergency is cancelled.
2. The radio returns to your default selected talk group. The “EMERGENCY” display is removed from the main screen.



An Emergency Alert can only be cleared by the dispatcher or the initiator.

An Emergency Call can be cleared by the dispatcher, the initiator, or someone whose radio has supervisory privileges.

8.25 DYNAMIC REGROUPING

Dynamic regrouping requires that the network administrator determine which radio users should be formed into an impromptu talk group to respond to particular emergency conditions.

The administrator will edit the personalities of the affected radios to include an emergency profile and then page the affected radios to re-register with the network to receive their edited personalities.

In response, affected radios automatically re-register to receive their edited personalities. During re-registration, subscriber equipment will default to the emergency profile selected by the administrator.

8.26 GPS COORDINATES

The radio’s current latitude and longitude coordinates may be displayed using the “GPS” menu. The following procedure assumes a GPS antenna is connected to the radio and it is receiving adequate signals from GPS satellites.

1. Press or until the “GPS” menu appears in the display. Current GPS coordinate latitude and longitude data continuously scrolls in the top line of the display in a degrees:minutes:seconds format.
2. Press or to change to another menu.



If the internal GPS receiver’s data is expired (30 minutes or more) or unavailable, the radio uses the serving base station’s coordinates [GPS (Site) is displayed]. The GPS Menu will also indicate if the data is aged (2 minutes or more) [GPS (Aged) is displayed]

EDACS OPERATION

9 EDACS OPERATION

9.1 TURNING ON THE RADIO

1. Power ON the radio by rotating the POWER ON-OFF/VOLUME knob clockwise. A short alert signal (if enabled through programming) indicates the radio is ready to use. Refer to Figure 7-2 for location of the POWER ON-OFF/VOLUME KNOB.
2. The display shows the last selected system and group or a default system and group (depending on programming).
3. Adjust the POWER ON-OFF/VOLUME knob to the desired volume level.
4. Select the desired system and group. The display indicates the current system and group names.
5. The radio is now ready to transmit and receive calls.



NOTE

In the trunked environment, CC SCAN will be displayed if communication with the system's control channel cannot be established. This may occur if, for example, the radio is out of range of the trunking site. It may be necessary to move to another location or select another trunking system to re-establish the control channel link for trunked mode operations. CC SCAN is displayed on the group line until a control channel is accessed.

9.2 CONTROLS

The radio features two rotary control knobs and an emergency button mounted on the top of the radio. Push-To-Talk and option buttons are mounted on the side. The front mounted keypad has six buttons on the P5350 Scan model and 15 buttons on the P5370 System Radio.

9.2.1 Buttons and Knobs

This section describes the primary function of the button and knob controls. Other functions associated with these controls are detailed in later sections.

POWER ON-OFF VOLUME KNOB Applies power to and adjusts the receiver's volume. Rotating the control clockwise applies power to the radio. A single alert tone (if enabled through programming) indicates the radio is operational.

Rotating the control clockwise increases the volume level. Minimum volume levels may be programmed into the radio to prevent missed calls due to a low volume setting. While adjusting the volume the display will momentarily indicate the volume level (i.e. **VOL=31**). The volume range is from a minimum programmed level of zero (displayed as **OFF** in the display) up to 31, which is the loudest level.

CONTROL KNOB Selects systems or group/channels (depending on programming). This is a 16-position rotary knob.

Note: A mechanical stop, which can limit the positions accessed, is shipped with the radio but must be installed. To install the mechanical stop, remove the voice group selection knob, loosen the set screw on the voice group selection knob metal base (using a 1.27 mm hex wrench), and remove the voice group selection knob metal base. Replace the 16 channel ring with the channel stop ring located at the desired channel. Reinstall the voice group selection knob metal base, tighten the set screw, and reinstall the voice group selection knob.

**EMERGENCY/
HOME BUTTON**

Automatically selects the pre-programmed Group/System by pressing and holding for a programmed duration. It can also be used to declare an emergency by pressing and holding for a programmed duration. The button must be pre-programmed for either operation, but not both.

PTT BUTTON

Push-To-Talk must be pressed before voice transmission begins. In trunked mode the radio's ID is transmitted upon depression of the PTT button. (Refer to Figure 7-3.)

**SIDE OPTION
BUTTON 1 ○**

Exits the current operation (removing all displays associated with it) and returns the radio to the selected talk group. Terminates individual and telephone interconnect calls.

**SIDE OPTION
BUTTON 2 ⊙**

Activates one of a number of programmable software options selected during PC programming. Programmable options include hi/low power settings, keypad lock, LCD contrast, LCD and keypad back lighting.

9.2.2 Keypad

The keys on the keypad have special functions and are labeled using a symbol or abbreviated word describing its primary function. Alpha-numeric entry is a secondary function of the keys. Each key is described in the following subsections.

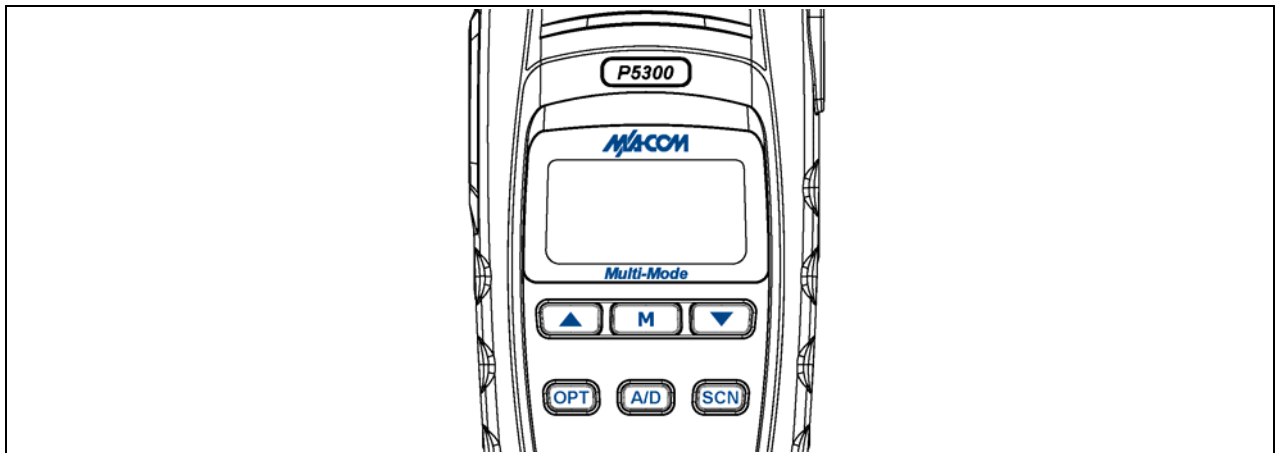

Figure 9-1: P5350 “Scan” Radio Front Panel

Table 9-1: P5300 Keypad Functions

KEY	FUNCTION
M	<u>Primary Function:</u> Accesses the pre-stored menu. <u>Secondary Function:</u> Activates a selected item within the menu. This is similar to an “Enter” key.
▲ ▼	Scrolls thru available menu items (see Table 8-4).
OPT (P5350 only)	Adds/Deletes selected groups or channels from SCAN list of the currently selected system.
SCN (P5350 only)	Toggles SCAN operation ON and OFF.
A/D (P5350 only)	Activates one of any programmable software options selected during the PC programming, including: high/low TX power and talkaround.



Figure 9-2: P5370 “System” Radio Front Panel

KEY	FUNCTION
M	Primary Function: Accesses the pre-stored menu. Secondary Function: Activates a selected item within the menu. This is similar to an “Enter” key.
▲ ▼	Primary Function: Allows the user to scroll through available systems, groups, or channels, depending on personality programming. Secondary Function: Changes the selection for an item within a list.
1 SYS 2 GRP 3 SCN 4 PVT 5 6 ADD 7 STS 8 MSG 9 DEL 0	Primary Function: Refer to the separate key definitions within this table. Secondary Function: These keys function much as a typical DTMF telephone pad 0-9, *, and # keys; and are used to place telephone interconnect and individual (unit-to-unit) calls.
1 SYS	Selects a specific system. If the rotary knob is used to select the system and more than 16 systems are programmed in the radio, the [1 ST SYS] key is used to select additional banks (groupings) of systems.
2 GRP	Selects a specific group.
3 SCN	Turns the Scan operation ON and OFF.
4 PVT	Not applicable
6 ADD	Adds groups or channels from the currently selected system to the Scan list.
7 STS	Status. Access to the status list (0-9). The Status key permits the transmission of a pre-programmed status message to an EDACS site.
8 MSG	Message. Access to the message list (0-9). The Message key permits the transmission of a pre-programmed message to an EDACS site.
9 DEL	Deletes selected groups or channels of the currently selected system from the Scan list.
* PHN	Places telephone interconnect calls.
# IND	Initiates individual calls.

9.3 DISPLAY

The radio Display is made up of 3 lines (see Figure 9-3). Lines 1 and 2 contain eight alphanumeric character blocks and are used primarily to display system and group names. Line 1 also displays radio status messages. The 3rd line is used primarily to display radio status icons. All three lines are used to display menu options when in the menu mode. If programmed, the display backlighting will illuminate upon power up or when radio controls are operated.

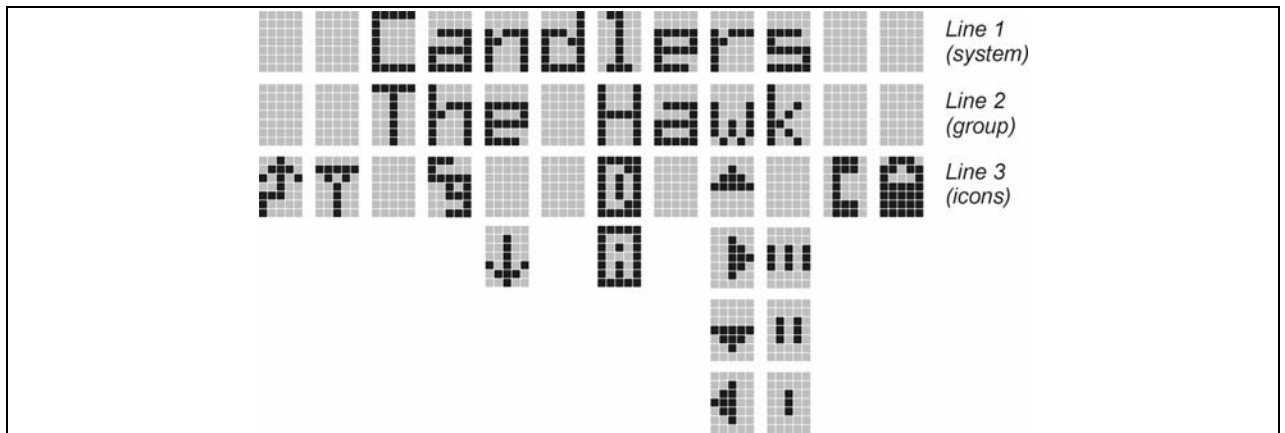















Figure 9-3: Radio Display

9.4 RADIO STATUS ICONS

Status Icons indicate the various operating characteristics of the radio. The icons show operating modes and conditions and appear on the third line of the display (see Table 9-2).

Table 9-2: Display Descriptions

	Steady – “Busy” transmitting or receiving. Appears in the 2 nd position of the display. Flashing – call queued
	Steady – special call mode (individual or telephone). Appears in the 11 th position of the display.
	Steady – during all radio transmissions. Appears in the 1 st position of the display
	Steady – transmit at low power. Appears in the 5th position of the display. If icon is not visible – transmit at high power
	Steady – battery charge indicator. Appears in the 12th position of the display. Flashing – Low battery indicator.
	Steady – Indicates the current channel is set up as an analog channel. Appears in the 7th position of the display.
	Steady – trunked system in Failsoft™ mode. Appears in the 4th position of the display.
	Steady – group or channel in scan list. Appears in the 10th position of the display.
	Steady – priority 2 group or channel. Appears in the 10th position of the display.
	Steady – priority 1 group or channel. Appears in the 10th position of the display.
	Steady (rotates clockwise) – scan mode enabled. Appears in the 9th position of the display. If icon is not visible – scan is disabled
	Steady – transmit in encrypt mode. Appears in the 6th position of the display. Flashing – receiving an encrypted call
	Steady – Indicates the current channel is set up as a ProVoice or Aegis channel. Appears in the 7th position of the display.

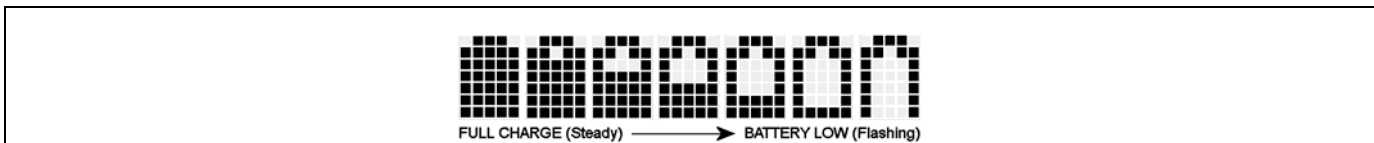

Figure 9-4: Full Cycle Battery Charge Indicator

The battery charge indicators illustrate approximate level only, based on battery voltage. Refer to Figure 9-4.

9.5 TRI-COLOR LED

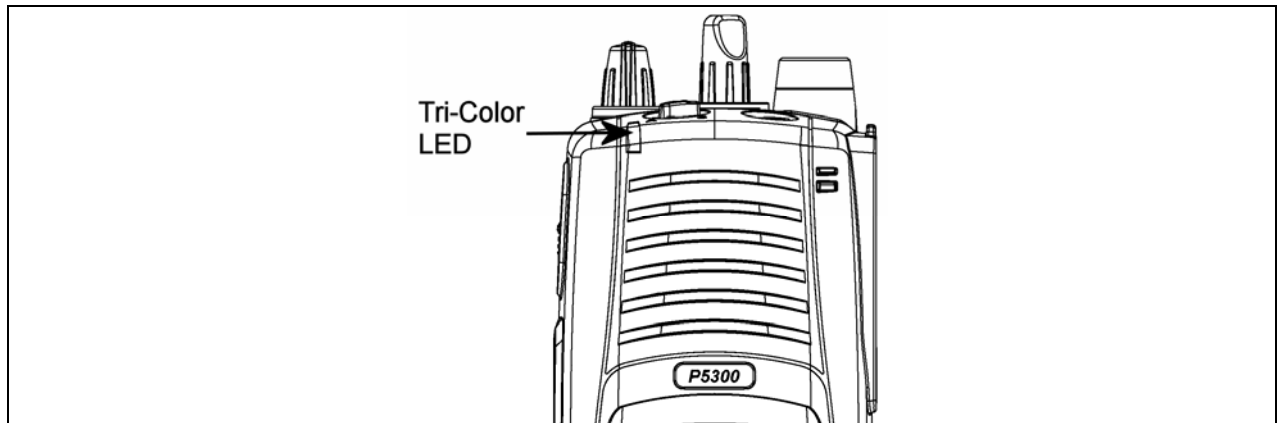

Figure 9-5: Tri-Color LED

The Tri-Color LED changes color to indicate radio status and is visible from both the front and top of the radio (see Figure 9-5). The colors of the LED and the status they represent are defined below.

Green: Receiving
 Red: Transmitting

If the LED is flashing rapidly, the radio is receiving an emergency call. If the LED is flashing every ½ second, the selected talk group is in the emergency state (although not transmitting). If the selected talk group is in the emergency state, an asterisk will be displayed next to the talk group name.

9.6 STATUS MESSAGES

During radio operation, various radio Status Messages can be displayed. The messages are described below.

<u>MESSAGE</u>	<u>NAME</u>	<u>DESCRIPTION</u>
<u>QUEUED</u>	Call Queued	Indicates the system has placed the call in a request queue.
<u>SYS BUSY</u>	System Busy	Indicates the system is busy, no channels are currently available, the queue is full, or an individual call is being attempted to a radio that is currently transmitting.
<u>DENIED</u>	Call Denied	Indicates the radio or talkgroup is not authorized to operate on the selected system and/or talkgroup.
<u>CC SCAN</u>	Control Channel Scan	Indicates the control channel is lost and the radio has entered the Control Channel Scan mode to search for the control channel (usually out of range indication).
<u>WA SCAN</u>	Wide Area Scan	Indicates the radio has entered the Wide Area Scan mode to search for a new system (if enabled through programming).
<u>SYSC ON</u>	System Scan Features On	Indicates the System Scan features are enabled.

<u>MESSAGE</u>	<u>NAME</u>	<u>DESCRIPTION</u>
SYSC OFF	System Scan Features Off	Indicates the System Scan features are disabled.
LOW BATT	Low Battery	Battery voltage has dropped to the point to where the radio is no longer able to transmit. The radio will still receive calls until the battery is discharged beyond the point of operation at which time the radio automatically shuts down.
RXEMER	Receive Emergency	Indicates an emergency call is being received. This message will be flashing on line two.
TXEMER	Transmit Emergency	Indicates an emergency call has been transmitted on this radio. This message will be flashing on line two.
VOL=31	Volume Level	Indicates the current volume level. The volume level display ranges from OFF (silent) to 31 (loudest).
WHC	Who Has Called	Indicates an individual call has been received, but not responded to. The indicator turns OFF if the individual call mode is entered, the system is changed, or the radio is turned off and then on again.
UNKNOWN	Unknown ID	Indicates an individual call is being received from an unknown ID.

9.7 ERROR MESSAGES

If either of the Error Messages shown below is displayed, the radio is programmed incorrectly or needs servicing.

```
DSP ERR      or  DIG U
ERR=XXXXX    ERR
(PowerUp
only)
```

Where **xxxxx** is the error code and **DSP ERR** or **DIG U ERR** is the message.







9.8 ALERT TONES

The P5300 radio provides audible Alert Tones or “beeps” to indicate the various operating conditions (see Table 9-3).

Table 9-3: Alert Tones



NAME	TONE	DESCRIPTION
Call Originate	one short mid-pitched	<i>OK to talk after pressing the push-to-talk button</i>
Call Queued	one high-pitched	<i>Call queued for processing</i>
Autokey	one mid-pitched	<i>Queued call received channel assignment</i>
System Busy	three low-pitched	<i>System busy or unable to complete call</i>
Call Denied	one low-pitched	<i>Radio is not authorized on the system or group</i>
Carrier Control Timer	five high-pitched / one long low-pitched	<i>PTT depressed for maximum length of time</i>
Low Battery	one low-pitched / one short mid-pitched	<i>Low battery</i>
TX Low Battery Alert	one low-pitched	<i>After PTT - battery too low to transmit</i>

9.9 SYSTEM SELECTION

- METHOD 1:** From the control knob: If system selection is programmed to the SYSTEM/GROUP/CHANNEL SELECTION control knob, select a system by turning the knob to the desired system number position (1-16). The display registers the new system name on line one. The  button can be programmed to provide access to a “2nd bank” of 16 system number positions (17-32).
- METHOD 2:** From the keypad: If system selection is programmed as the primary function of  and  select a system by pressing  or  to scroll through the system list. The display registers the new system name on line one.
- METHOD 3:** **(P5370 model radios only)** Direct Access: Press  to enter the system select mode. Press the numeric key, which is mapped to the desired system. Press . The radio will move to the selected system.



NOTE

If system selection is programmed to the SYSTEM/GROUP/CHANNEL knob, direct access to systems will not be available. Pressing  or  will scroll through different sets of 16 systems each (banks) if more than 16 systems are programmed into the radio. The systems within each bank are then selectable via the Voice group selection knob as described previously in METHOD 1.

Example:

System: 1 = North	Group: 1 = Group 1
2 = South	2 = Group 2
3 = East	3 = Group 3
4 = West	4 = Group 4

1. Press **[1 SYS]**. (South is the currently selected system.)
2. Press **[4 PVI]**. (Press 4 to select “West” system.)
3. Press **[M]**. (West is the newly selected system.)

9.10 GROUP/CHANNEL SELECTION

Several methods can be used to select a new group or channel.

METHOD 1: From the control knob: If group selection is programmed to the Voice group selection knob, select a group by turning the Voice group selection knob to the desired group number position. The display registers the new group name on line two. If the knob is moved to a position greater than the number of programmed groups, the highest programmed group will remain selected. The **[O]** button can be programmed to provide access to a “2nd bank” of 16 group number positions (17-32).

METHOD 2: From keypad: If group selection is programmed as the primary function of **[▼]** and **[▲]** select a group by pressing **[▼]** or **[▲]** to scroll through the group list. The display registers the new group name on line two.

METHOD 3: (**P5370 model radios only**) Direct Access: Press **[2 DAP]** to enter the group select mode. Press the numeric key mapped to the desired group. Press **[M]**. The radio will move to the selected group.

9.11 MODIFY SCAN LIST

9.11.1 P5370 Model

1. Press **[3 SCN]** to toggle scan OFF and verify  is **not** displayed.
2. Select group or channel.
3. Press **[9 DEL]** once to remove group or channel from list.
4. Press **[6 ADD]** once to add as a normal group or channel.
5. Press **[6 ADD]** twice to add as a Priority 2 group.
6. Press **[6 ADD]** three times to add as a Priority 1 group.
7. Press **[3 SCN]** to re-start scanning.

9.11.2 P5350 Model

1. Press **[SCN]** to toggle scan OFF and verify  is **not** displayed.
2. Select group or channel.
3. Press **[ADD]** once to remove group or channel from the list.
4. Press **[ADD]** once to add as a normal group or channel.

5. Press **[AD]** twice to add as a Priority 2 group.
6. Press **[AD]** three times to add as a Priority 1 group.
7. Press **[SCN]** to re-start scanning.





9.12 BACKLIGHT ON/OFF

1. Press **[M]** to access the menu.
2. Press **[v]** or **[^]** to scroll through menu until “BCKLGHT” appears.
3. Press **[M]** to select Backlight menu.
4. Press **[v]** or **[^]** to toggle backlight ON and OFF.
5. Press **[M]** to select new backlight setting.

9.13 CONTRAST ADJUST

1. Press **[M]** to access the menu.
2. Press **[v]** or **[^]** to scroll through menu until “CONTRAST” appears.
3. Press **[M]** to select Contrast menu.
4. Press **[v]** or **[^]** to adjust contrast setting from 1 - 4.
5. Press **[M]** to select new contrast setting.

9.14 DECLARING AN EMERGENCY

1. Press and hold the red Emergency/Home button (the length of time is programmable; check with the system administrator).
2. ***TXEMER*** will flash in the display, plus  and  will be displayed. After 2-3 seconds the transmit icon  will turn off.
3. ***TXEMER*** and  will remain until the emergency is cleared.
4. Press the PTT and  will reappear.
5. Release PTT when the transmission is complete.

9.15 LOCKING/UNLOCKING KEYPAD

1. Press **[M]** button.
2. Within 1 second, press the **[O]** button on the side of the radio.

9.16 HIGH/LOW POWER ADJUSTMENT

Transmit power adjustment is possible if enabled through programming. Within conventional systems, transmit power is adjustable on a per channel basis. Within EDACS trunking systems, transmit power is adjustable on a per system basis.

There are two ways to toggle between high and low power, described in Sections 9.16.1 and 9.16.2.

9.16.1 Using the Menu Button

1. Press **M**.
2. Using the **▼** or **▲** keys, scroll until the cursor (>) appears to the left of “TX POWER” in the display.
3. Press **M** again to toggle between High and Low power.
4. “POWER = HIGH” or “POWER = LOW” will appear momentarily on the top line of the display.

9.16.2 Using the Pre-Programmed Option Button

Press the Option button. “POWER = HIGH” or “POWER = LOW” will appear momentarily on the top line of the display.

9.17 MENU

The Menu function accesses features that are not available directly from the keypad. The order and actual menu items available is configurable through programming. Upon radio power up, the menu item that is at the top of the menu list will always be displayed first. Subsequent access to the menu function will return the last menu item that was shown in the display and cursor position.

1. To enter the menu mode, press **M**.
2. Upon entering the menu selection mode, Menu options will appear in the display (see Figure 9-6).

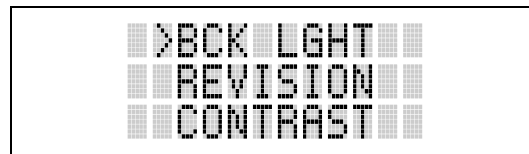

Figure 9-6: Menu Display

3. The radio will continue to receive and transmit normally while in the menu function.
4. To scroll through the menu options use the **▼** or **▲** keys. When the required menu item has been found align the cursor with the option then press **M** to select it. The menu item's parameter setting shown in the display can now be changed by using **▼** or **▲** to scroll through the list of parameter values.
5. Once the desired setting is reached press **M** to store the value and return the menu option selection level.

For menu items that display radio information, pressing **▼** or **▲** will scroll through a list of informational displays. The possible menu items are in Table 9-4.

9.17.1 Menu Item Selection Process

An example of the menu item selection process and menu item parameter change is shown in Figure 9-7 for the backlight menu item.

1. Press **M**. The menu mode is entered.
2. Press **▼** or **▲** until the display shows:

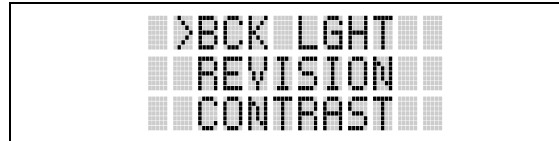

Figure 9-7: Backlight Menu Item Selection Parameter

3. Press . The backlight menu item is activated. Line one shows the active menu item and its current parameter setting. Line two shows the currently selected system or group name (see Figure 9-8).

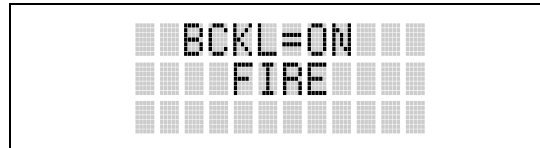

Figure 9-8: Backlight Menu Display

4. The menu item's parameter setting shown in the display can now be changed by using or .
5. Once the desired setting is reached press to store the value and return the menu option selection level.

For menu items that display radio information pressing or will scroll through a list of informational displays. An example of information displays is shown in Table 9-5.



The TX POWER menu item, when selected, toggles LOW/HIGH power. It does not use or to scroll nor is an additional press of the button required.

Table 9-4: Menu Item Information

FEATURE	DISPLAY	PARAMETER SETTING	COMMENT
Keypad Lock	Menu Item: KEY LOCK Once Selected: LOCKED	Locked Unlocked	Locks the keypad. To unlock; press and release M then within 1 second press the option button <i>NOTE:</i> This sequence is also a short cut to locking the keypad.
Backlight Adjust	Menu Item: BCK LIGHT Once Selected: BCKL=	OFF/ON	Selects the light level for backlighting.
Contrast Adjust	Menu Item: CONTRAST Once Selected: CNTRST=	1, 2, 3, 4	Selects the display contrast level.
Transmit Power Select	Menu Item: TX POWER Once Selected: POWER=	HIGH or LOW	Selects radio output power mode.
Radio Revision Information	Menu Item: REVISION	N/A	Selects the information display to view. Informational display only (see Table 9-5). <i>No user selectable settings.</i>
Toggle Scan On/Off	SCAN	ON/OFF	Toggles Scan operation ON/OFF.
Display Current Home Group/Channel	HOME	N/A	Selects Home Group/Channel
Select Desired System	SYS SEL	N/A	Selects a new system.
Add Group/Channel to Scan List	SCAN ADD	N/A	Adds to Scan List.
Delete Group/Channel	SCAN DEL	N/A	Deletes Group or Channel from Scan List.
Add/Delete Scan List	SCAN A/D	N/A	Add or Delete from Scan List.
Select Telephone Numbers From Phone List	PHN CALL	N/A	Trunked Only.
Data Operation	NO DATA	ON/OFF	Trunked Only. Toggles Data Operation ON/OFF.
Select Individual Call from IC List	IND CALL	N/A	Trunked Only.
Select Group	GRP SEL	N/A	Trunked Only.
Feature Encryption Display	Menu Item: FEATURES	N/A	Indicates current features programmed into the radio as well as certain information required to add features to the radio. <i>Informational display only. No user selectable settings.</i>
System Scan Enable	Menu Item: SYS SCAN Once Selected: SYSC ON or SYSC OFF	ON/OFF	Toggles System Scan feature ON/OFF.

Table 9-5: Information Display

RADIO ID XXXXXXXX	LID in EDACS/EA In CONV it has no meaning.
RAM SIZ	RAM Size
FLSH SIZ	Flash Size
RF BAND	Frequency Band
PERS VER	Software Version
DSP DATE	Date DSP code was built.
DSP TIME	Time DSP code was built.
DSP FEAT	The DSP Features supported by the DSP code, in Hexadecimal. Bit mapped (see IPC spec for details): <ul style="list-style-type: none"> • 0x0001 – Conventional • 0x0002 – EDACS • 0x0010 – AMPF • 0x0020 – undefined
DSP VER	DSP Software Version
FLSH VER	FLASH Software ex: P53U0102 P=portable, 53=5300 radio, U=unencrypted, 01=major revision (>50 means unreleased code), 02=minor revision
M/A-COM (C) 2007	Copyright
PERSNLTY	Personality Name
BLD DATE	Date host (ARM) code was built.
BLD TIME	Time host (ARM) code was built.

9.18 DIGITAL VOICE OPERATION

Digital voice programmed systems have two (2) different voice modes: clear (analog) and digital. The voice modes are programmed on a per-group basis within each trunked system.

9.18.1 Clear Mode

The Clear Mode is a voice mode in which the radio transmits and receives only clear (analog) voice signals. These analog signals are non-digitized and non-encrypted. Clear mode transmissions can be monitored easily by unauthorized persons.



NOTE

Groups or channels programmed for clear operation cannot transmit or receive digital messages.

9.18.2 Digital Mode

The Digital Mode allows the radio to transmit and receive digitized voice signals. Digital signals provide improved weak signal performance and cannot be easily monitored with a standard receiver. Groups and channels programmed for digital operation transmit only digital signals. Message trunked group calls and individual phone calls (I-Calls) are answered back in the mode in which they were received assuming the

call or hang time is still active. Individual phone, all call, and emergency calls are transmitted clear if the digital mode is disabled or inoperative.

If receiving an analog message trunked call, the radio responds in the analog mode during the hang time on the working channel.

If receiving an analog I-Call, the radio responds in the analog mode during the hang time.

When using the ***WHC*** feature to respond to an I-Call (after the hang time has expired), the call is transmitted in the mode defined by the system mode as programmed for the current system if the ID being called is not in the I-Call list. If the ID is in the I-Call list, then the call is transmitted as defined by the I-Call mode programmed in the list for that ID.

The over dial DTMF tones are not available while in the Digital Mode.

9.18.2.1 Scanned Group Calls

Receiving a Scanned Group Call is the same as receiving a selected group call. During the scan hang time, if the radio was programmed for autoselect, it will transmit back in the same mode it received the call. For example, if a clear group is entered in the scan list, it will only receive clear calls. If the same group was available in digital and entered in the scan list, it can receive clear and digital calls, provided autoselect was programmed in the radio. The user can select transmitting on the scanned or selected group. If a group is entered in the scan list more than once and in different modes (clear or digital), only the first occurrence of the group will be used.







Table 9-6: Transmit/Receive Mode Compatibility for Digital Voice Operation

GROUP/CHANNEL PROGRAMMING (TRANSMIT)	CLEAR RECEIVE	DIGITAL RECEIVE
CLEAR	Yes	No
DIGITAL	Yes	Yes

9.19 SCANNING TRUNKED GROUPS







Groups that have been previously added to the scan list on a per system basis may be scanned. Each system's group scan list is retained in memory when the radio is powered OFF or when the battery pack is removed.

9.19.1 Turning Scan On and Off

1. Toggle Scan operation ON by pressing  (P5350 model) or  (P5370 model).  icon rotates clockwise to indicate radio is scanning.
2. Toggle Scan operation OFF by again pressing  (P5350 model) or  (P5370 model).  will disappear.
 - If the radio scans to a group other than the selected group then receives a call on the selected group, the radio will switch to the selected group. However, if the “scanned-to” group is programmed at a higher priority the radio will remain on the “scanned-to” group.
 - The radio will continue scanning if a new group is selected when scan is ON.
3. Pressing the PTT button when scan is ON will cause the radio to transmit on the displayed group or to the currently selected group (depending on programming).

9.19.2 Adding Groups to a Scan List

P5350 Model Radio

1. Scan must be OFF to add/delete groups to/from the scan list. If the Scan icon  is ON, press the **SCN** key to turn Scan OFF.
2. Select the desired group using the Voice group selection knob and/or the **▼** or **▲** keys. If the selected group is currently on the list, pressing **ADD** will display  on line three.
3. If the scan list status icon is blank () , the group can be added to the scan list by pressing the **ADD** key.  will be displayed on line three.
4. Press the **ADD** key a second time to set the group to Priority 2. A  is displayed on line three.
5. Press **ADD** a third time to set the group to Priority 1. A  is displayed on line three. The priority level section sequence only advances the group to the next high priority level and stops at priority level 1. To select a lower priority level, the group must be deleted from the scan list and then added back to the scan list. Each new group added to the scan list starts at the lowest priority. If the Priority 1 and Priority 2 groups are already set and a new group is assigned as Priority 1 or Priority 2, the previously assigned group will change to non-priority scanning. One of the following messages may be momentarily displayed.

SCAN DIS The radio is not programmed to scan.

FIXED P1 A Priority 1 group has been pre-programmed into the radio. A new Priority 1 group cannot be selected.



FIXD LST A fixed scan list has been pre-programmed into the radio. It is not possible to change the list without reprogramming the radio.



NOTE

To quickly view multiple group scan status, press **ADD** then slowly but consistently rotate the group knob. Each group status will appear on the display.

P5370 Model Radio

1. With scan operation turned OFF, select the desired group to add to the selected trunked system group scan list.
2. Press **ADD**. The current priority status of the group will be displayed in column 10 of line three for a time-out period. If the group is not part of the scan list the status will be blank.
3. While the status is displayed, press **ADD** to add the group to the scan list.  is displayed on line three.
4. Press **ADD** a second time to set the group to Priority 2. A  is displayed on line three.

- Press **[6 ADD]** a third time to set the group to Priority 1. A **[1]** is displayed on line three. The priority level selection sequence only advances the group to next higher priority level and stops at priority level 1. To select a lower priority level, the group must be deleted from the scan list and then added back to the scan list. Each new group added to the scan list starts at the lowest priority. If the Priority 1 and Priority 2 groups are already set and a new group is assigned as Priority 1 or Priority 2, the previously assigned group will change to non-priority scanning. One of the following messages may be momentarily displayed.

SCAN DIS The radio is not programmed to scan.

FIXED P1 A Priority 1 group has been pre-programmed into the radio. A new Priority 1 group cannot be selected.

FIXD LST A fixed scan list has been pre-programmed into the radio. It is not possible to change the list without reprogramming the radio.



NOTE

To quickly view multiple group scan status, press either **[6 ADD]** or the **[9 DEL]** key. Then slowly but consistently rotate the group knob. Each group status will appear on the display.

9.19.3 Deleting Groups from a Scan List

P5350 Model Radio

- With scan operation turned OFF, select the desired group to delete from the selected trunked system group scan list.
- Press **[ADD]**. The current status of the group is displayed for a time-out period.
- While the current status is displayed, press **[ADD]** until the group from the scan list is "blank". The sequence is "blank", **[1]**, **[2]**, **[3]**, "blank". Any group that is not in a trunked system group scan list will show a "blank" for the time-out period when it is the selected channel.

P5370 Model Radio

- With scan operation turned OFF, select the desired group to delete from the selected trunked system's group scan list.
- Press **[9 DEL]**. The current status of the group is displayed for a time-out period.
- While the status is displayed, press **[9 DEL]** to delete the group from the scan list. **[1]**, **[2]**, or **[3]** turns OFF. Any group that is not in a trunked system group scan list will show a "blank" for the time out period when it is the selected channel.

9.19.4 Nuisance Delete

A group can also be deleted from the scan list, if it is not the currently selected group, by pressing the **[ADD]** key (P5350 model) or the **[9 DEL]** key (P5370 model) during scan operation while the radio is displaying the unwanted group. The group will be deleted from the system's group scan list in the same manner as if done using the steps above. Deletions done in this manner will not remain deleted if the radio is powered OFF and then powered ON.

9.20 SCANNING TRUNKED SYSTEMS

The radio can be programmed with the following System Scan features. These features are automatically enabled when the radio is powered ON. A key or menu option is also defined to allow the System Scan features to be toggled during radio operation. The System Scan state will be maintained through system changes but will default to ON when the radio is powered ON.

Enable/Disable via Menu Selection

Press **[M]** and then use the **[▼]** or **[▲]** buttons to scroll through the selections until **SYS SCAN** is displayed. Then press **[M]** to toggle the System Scan state. The **SYSC ON** or **SYSC OFF** display message is displayed for two seconds to show the new state.

Enable/Disable via Pre-Programmed Keypad Key

Press the key pre-programmed to toggle System Scan and the **SYSC ON** or **SYSC OFF** display message is displayed for two seconds to show the new state.

9.20.1 Wide Area System Scanning

The P5300 series radio can be programmed for Wide Area System Scan operation for roaming across mobile systems. Upon the loss of the currently selected system's control channel, radios can be programmed to automatically scan the control channels of other systems. If a new control channel is found, the radio will switch to the new system and sound an alert tone.

9.20.2 Priority System Scan

The radio can also be programmed for Priority System Scan. The priority system is the desired or preferred system. While receiving the control channel of the selected system, the radio will periodically leave the selected system and search for the control channel of the priority system. This is done at a programmable rate defined by the value in the Priority Scan Time control (unless the ProScan™ algorithm is enabled, as explained in the following sections). This priority scan timer is reset each time the PTT button is pressed or when the call is received. If the priority system control channel is found, (or meets the predefined criteria <ProScan>), the radio will automatically switch to the priority system.

9.20.2.1 Enabling the Wide Area System Scan Function

If the radio cannot find the control channel of the selected system and begins to wide area system scan, the radio will only scan for the priority system control channel if the priority system is in the wide area scan list.

9.20.2.2 When ProScan is Enabled

The radio monitors the priority system and will switch to the priority system if the criteria defined by the controls in the ProScan Options dialog box are met. If ProScan is enabled, the rate at which the radio will scan for the priority system is defined by the System Sample Time control, located in the ProScan Options dialog box. See Section 9.20.3 for more information on ProScan.

9.20.3 ProScan

The radio may be programmed for ProScan system scan operation for multi-site applications depending on the version of radio flash code. ProScan is an improved multi-site system scanning algorithm designed to replace ProSound™ scanning. ProScan provides the radio with the ability to select a new system for the radio to communicate on, when the selected system drops below a predefined level. This is accomplished by enabling each radio to analyze the signal quality of its current control channel and compares it with the

signal quality of the control channel for each site in its adjacent scan list. (The signal quality metric used for the ProScan algorithm is based on a combination of both **Received Signal Strength Indicator (RSSI)** and **Control Channel Verification (CCV)** measurements.) When the selected system degrades to a pre-programmed level, the radio will begin to look for a better control channel. Once a control channel that exceeds the pre-programmed parameters is found, the radio will change to the new system and emit a tone (if enabled through programming). If the control channel is completely lost, the radio will enter Wide Area System scanning and search the programmed adjacent systems until a suitable control channel is found.

9.21 EMERGENCY OPERATION



The radio's ability to declare an emergency, clear an emergency, remain locked on an emergency system and group, and the emergency audio and display freeze can each be enabled or disabled through programming. When an emergency is declared scanning will stop and restarts only after the emergency has been cleared.



9.21.1 Receiving an Emergency Call

When receiving an Emergency Call on the selected group and system, an alert beep is heard and  is displayed. The message ***RXEMER*** flashes in the display on line two until the emergency condition is cleared.

9.21.2 Declaring an Emergency Call



Perform the following steps to send an emergency call to a selected system and group (or on an optionally pre-programmed group).

1. Press and hold the red EMERGENCY button that is on top of the radio in front of the antenna for approximately one second (this time is programmable and therefore could be longer or shorter; check with the system administrator). The radio will transmit an emergency call request with the radio ID until an emergency channel assignment is received.
2. When the working channel assignment is received, the radio sounds a single beep indicating the radio has auto keyed (see Table 9-3) and is ready for voice transmission. ***TXEMER*** flashes on line two in the display until the emergency is cleared.
3. Press PTT and speak into the microphone in a normal voice.  and  momentarily turn ON.
4. Release PTT when the transmission is complete.

To clear the emergency first press and hold the  button. While continuing to hold the  button, press the EMERGENCY button. (This will work if the radio is programmed to clear emergencies.)

9.22 INDIVIDUAL CALLS

9.22.1 Receiving and Responding to an Individual Call

When the radio receives an individual call (a call directed only to the user's radio), it un-mutes on the assigned working channel and displays . The first line on the display shows the logical ID number of the unit sending the message, or the associated name if the ID number is found in the individual call list. The radio can be programmed to ring when an individual call is received. If enabled, the ring begins five seconds after the caller un-keys and will continue until the PTT button, the  button or the individual call mode is entered.



The volume of the ring is adjustable through the volume control levels.

If a response is made by pressing the PTT to the call prior to the programmed call-back time-out, the call will automatically be directed to the originating unit. If a response is not made before the call-back time-out, the radio will return to normal receive display, and ***WHC*** will appear on the first line of the LCD.

To respond after the call-back time-out, press the **#NO** key. The radio's display will show the callers ID on the first line and **WHCI=1** on the second line. Pressing the PTT button at this point will initiate an individual call back to the original caller.

The radio stores the IDs of the last 10 callers in the Calls Received List as shown. Individual calls are stored in the top half of the list (1-10) and Group calls are stored in the bottom half of the list (1-10). The most recent call is stored in position 1, the second most recent call is stored in position 2, etc.

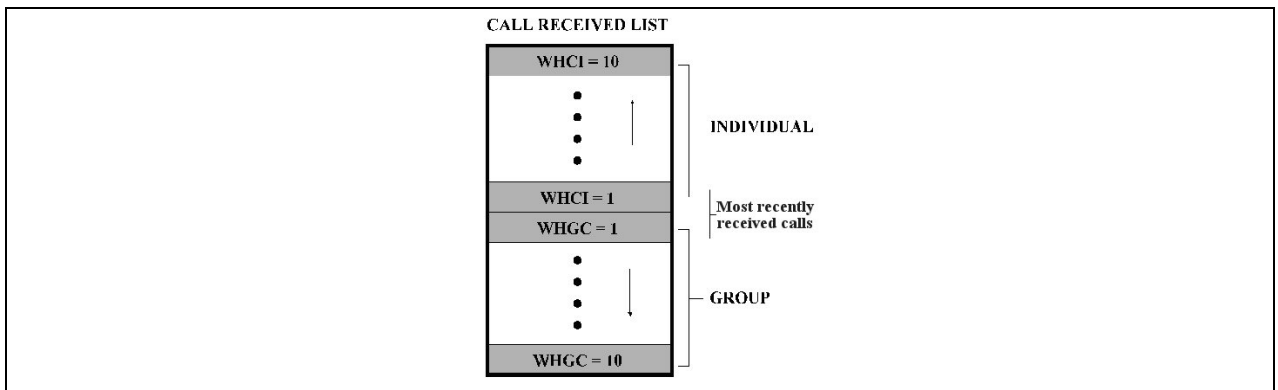

Figure 9-9: Calls Received Lists

To access the Calls Received List, press the **#NO** key twice. Use the **▼** or **▲** buttons to scroll through the list. Pressing the **M** key will display the time elapsed since the call was received. After pressing **#NO** the display will appear similar to Figure 9-10.

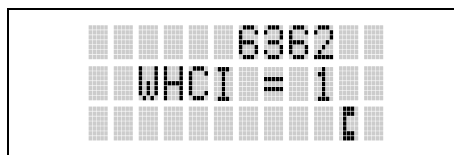

Figure 9-10: WHC Individual Call Display

Pressing the PTT will initiate an individual call to the displayed logical ID. Powering the radio OFF and ON will clear this list.

9.22.2 Sending an Individual Call

9.22.2.1 Pre-Stored Individual Calls

The following procedures describe how to initiate and complete a Pre-Stored Individual Call.

P5370 Model Radio

1. To select a pre-stored individual phone number, enter the individual call mode using the **#IND** key. **IND** is displayed. Then scroll through the list of stored numbers using the **▼** or **▲** keys.
2. Press the PTT button; when the radio is clear to transmit, **PTT** turns ON, **IND** turns OFF and the channel access tone sounds. Line one shows the called individual's name if found in the list of stored individuals or **LID** followed by the logical ID number of the unit being called. The message ***INDU*** displays on line two.

P5350 Model Radio

1. To select a pre-stored individual number, enter the menu mode by pressing the **M** key. Scroll through the mode list using the **▼** or **▲** buttons.
2. Press **M**. **IND** is displayed. Scroll through the list of stored phone numbers using the **▼** or **▲** buttons until the desired number is displayed. Press **M**.
3. Press the PTT button; when the radio is clear to transmit **PTT** turns ON, **IND** turns OFF and the channel access tone sounds. Line one shows the called individual's name or LID. The message ***INDU*** displays on line two.

9.22.2.2 Direct Dial Individual Calls (P5370 Model Only)

1. The following procedure describes how to initiate and complete a Direct Dial Individual Call.
2. The individual call ID is not stored in the pre-stored list of call IDs but the individual unit ID is known, it can be entered directly from the keypad.
3. Press and hold the PTT button to transmit. **PTT** will turn ON, **IND** will turn OFF, and the channel access tone will sound. Line one shows the called individual's ID followed by the logical ID number of the unit being called. The message ***INDU*** displays on line two. Proceed talking into the microphone.

9.22.3 Call Storage Lists

There are two lists available for call storage in the P5300 series radios, the **calls received** list (1 - 10) and the **personality** list (1 - 99 as defined by the user). When the individual call mode is entered by pressing **#IND**, the **calls received** list is available. The user can toggle to the personality list by selecting any index other than 0 or toggle between the two lists by pressing the **#IND** key. If wrap is enabled, the **calls received** list wraps on itself and not into the other list.

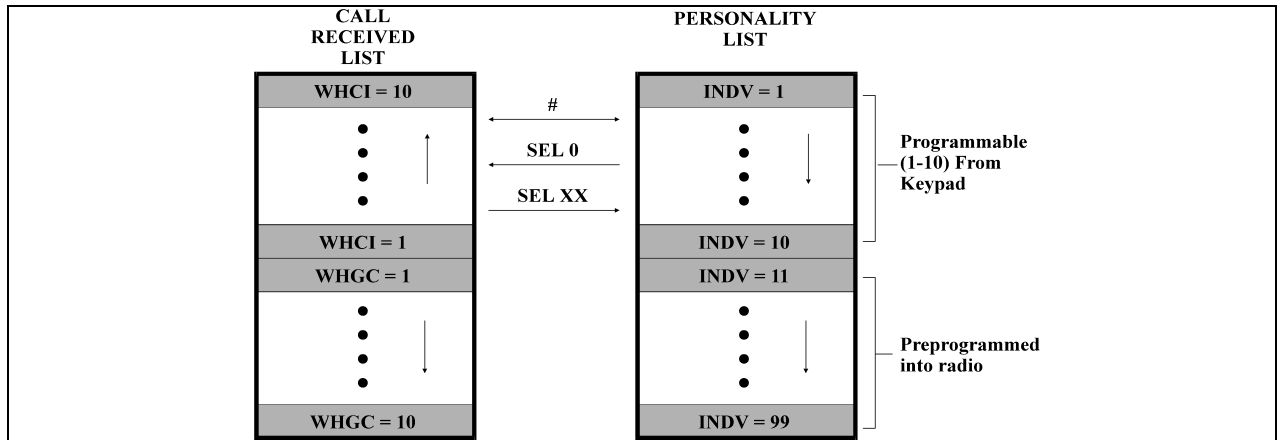

Figure 9-11: Calls Received and Personality Lists

The saved call list shows all ten storage locations. If no calls have been received, the saved call list will be empty and the pre-stored list will be available upon entering the individual call mode.

When in the saved call list, pressing the **[M]** key toggles the time stamp ON and OFF. The time stamp indicates how long ago the call was received. When in the pre-stored list pressing the **[M]** key toggles the Logical *ID*entification (*LID*) ON and OFF.

9.23 TELEPHONE INTERCONNECT CALLS

9.23.1 Receiving a Telephone Interconnect Call

When the radio receives a telephone interconnect call (a call directed only to the user's radio), it un-mutes on the assigned working channel and displays **[PTT]**. The first line displays ***PHONE***. The second line displays ***INDV***. Proceed with the call. Press the PTT to talk, release the PTT to listen.

9.23.2 Sending a Telephone Interconnect Call

9.23.2.1 Pre-Stored Number

Use the following procedures to initiate and complete a Telephone Interconnect call.

1. **P5370 Model:** To select a previously stored phone number, press the **[*PHN]** key. Use the **[▼]** or **[▲]** buttons to scroll through the list of stored numbers.

P5350 Model: To select a previously stored phone number, press the **[M]** key. Use the **[▼]** or **[▲]** buttons to select the menu option **PHN CALL**. Press the **[M]** key again then use the **[▼]** or **[▲]** buttons to scroll through the list of pre-stored numbers.

2. Press and release the PTT button. When the radio is clear to transmit, **[PTT]** turns ON, **[PTT]** turns OFF and the channel access tone sounds. Line one shows the accompanying name selected from the list of stored numbers. The message ***PHONE*** appears on line two of the display. The radio then automatically transmits the programmed number stored in the special call queue.
3. A telephone ring will be heard from the speaker. When someone answers the phone, press the PTT button and speak into the microphone. Release the PTT button to listen to the callee. Unsuccessful interconnect signaling returns the radio to the normal receive mode and the number remains displayed until the special call is cleared or the time-out expires or another group or system is selected. Terminate a call by pressing the **[⊙]** button.





In half-duplex mode, only one person may talk at a time. The radio PTT button needs to be pressed in order to communicate to the individual called and released for the individual called to be heard.

9.23.2.2 Direct Dialing of Phone Calls (P5370 Model Only)

1. If the phone number is not stored in the pre-stored list of phone numbers, but the phone number is known, it can be entered directly from the keypad. Start by pressing the  key, then enter the required number from the keypad. Press and release the PTT button.



The last number directly entered can be recalled by first pressing  then pressing the PTT button.

2. A telephone ring can be heard from the speaker. When someone answers the phone, press and hold the PTT button and speak into the microphone. Release the PTT button to listen to the individual called. Unsuccessful interconnect signaling returns the radio to the normal receive mode and the number remains displayed until the special call is cleared or the time-out expires or another group or system is selected.
3. To terminate the call, momentarily press the  button.





9.23.3 Dual-Tone Multi-Frequency: Overdial/Conventional Mode



Once the radio has established a connection to the public telephone system, it may be necessary to “overdial” more digits to access banking services, answering machines, credit card calls, or other types of systems that require Dual-Tone Multi-Frequency (DTMF) access digits.

Overdial operation can also be used to initiate a telephone interconnect call via DTMF signaling if a dial tone has already been accessed on the system. This method makes a telephone interconnect call while operating in the conventional mode but will also function in trunked mode if a dial tone is directly accessible.

Telephone numbers and other number sequences for overdialing can be stored in the phone list when programming the radio. These numbers are accessed by pressing the  key, then following the selection mode rules. Perform the following procedures to access and dial these stored numbers.

P5350 Model Radio

1. Follow the procedure in Section 9.23.2 to establish a connection to the telephone system or consult the system administrator for the procedure to access a dial tone on the trunked or conventional system.
2. Enter selection mode first to enable entry of Overdial numbers by pressing the  button.
3. Follow the selection mode rules to call up a stored number from the phone list: Use the  or  buttons to scroll through the list of stored numbers.  is displayed. Press the PTT to send the overdial sequence once. If the number needs to be transmitted again it must be selected or entered again (this prevents unwanted numbers from being sent the next time the PTT button is pressed during the call).

Overdial select/entry mode remains active until the call is dropped, cleared, or  is pressed. The overdial select/entry mode can be re-entered if the call is still active by pressing .

P5370 Model Radio

1. Follow the procedure in Section 9.23.2 to establish a connection to the telephone system or consult the system administrator for the procedure to access a dial tone on the trunked or conventional system.
2. Overdial numbers are transmitted using one of the following methods:

- METHOD 1:
1. Enter the overdial selection mode by pressing the **[* PIN]** button.
 2. Use the **[▼]** or **[▲]** buttons to scroll through the list of stored numbers. **[M]** is displayed. Press the PTT to send the overdial sequence once. If the number needs to be transmitted again it must be selected or entered again (this prevents unwanted numbers from being sent the next time the PTT button is pressed during the call).

Overdial select/entry mode remains active until the call is dropped, cleared, or **[M]** is pressed. The overdial select/entry mode can be re-entered if the call is still active by pressing **[M]**.

METHOD 2: **(P5370 model radios only)**

1. Enter the overdial selection mode by pressing the **[* PIN]** button.
2. Press and hold the PTT button while entering the overdial number sequence from the keypad. This method sends DTMF tones during individual, telephone interconnect, trunked group, or conventional channel calls. Press the PTT to send the overdial sequence once. If the number needs to be transmitted again it must be selected or entered again (this prevents unwanted numbers from being sent the next time the PTT button is pressed during the call). *Note: Anytime the PTT button is pressed and held, the keypad is enabled for DTMF entry.*

Overdial select/entry mode remains active until the call is dropped, cleared, or **[M]** is pressed. The overdial select/entry mode can be re-entered if the call is still active by pressing **[M]**.

This overdial select/entry mode remains active until dropped, cleared, or **[M]** is pressed. The overdial select/entry mode can be re-entered if the call is still active by pressing the **[* PIN]** button.

9.24 PROGRAMMABLE ENTRIES

9.24.1 Pre-Storing Individual and Telephone Interconnect Calls from the Keypad

Individual Call ID numbers, telephone numbers, and other number sequences for overdialing are stored in the special calls lists when programming the radio. The first ten entry locations of these lists can be changed by the radio operator. The keypad is used when adding, changing, and storing numbers in these entry locations.

Use the following procedure to store a number in one of the first ten entries of a special call list:

1. Press the **[# IND]** or **[* PIN]** button to enter the individual call list or the phone call list. **[M]** is displayed.
2. Scroll through the list using the **[▼]** or **[▲]** keys until one of the first ten entries is reached. **NO ENTRY** is displayed if the location is empty.
3. Enter the desired number. If necessary, a pause can be entered by pressing and holding 0-9, **[# IND]**, or **[* PIN]** until an underscore appears in the display (telephone interconnect only). The individual call list

entries will accept up to 5 digits. The phone call list entries accept a combination of up to 31 digits and pauses.

4. Press and hold the **[M]** key until the display changes indicating that the number has been stored.

Repeat steps 1-4 to store additional numbers, to change numbers already stored, or to change the storage location of a number.

9.25 STATUS/MESSAGE OPERATION

The **Status** and **Message** operations allow for the transmission of a *pre-programmed status* or a *pre-programmed message* to an EDACS site. Each Status and Message is assigned an ID then cross-referenced with the representative status condition (“Off Duty,” for example) or a message (“Call home”). In addition, Status conditions can also be associated with a programmable Menu entry (required for second method of transmitting a Status condition (see Section 9.25.1).

9.25.1 Status Operation

P5370 Model Radio

One of two methods can be used to transmit a status condition.

- METHOD 1:
1. Press the **[M]** key, then use the **[▼]** or **[▲]** buttons to scroll to the pre-programmed status condition. STATUS and 0 through 9 pre-programmed status selections are available from the menu.
 2. If STATUS is selected, you need to enter the number of the status condition you intend to transmit. If no status has been programmed for the selected number key, the radio will display **NO ENTRY**. A valid selection will display the status for a pre-programmed time.

After the time-out expires or the **[M]** key has been pressed (the **[M]** key will override the time-out period), the status is selected and will be transmitted to the site or stored in the radio memory where it can be polled by the site at a future time.

- METHOD 2:
1. Press the **[7/RTS/Phone]** key.
 2. Press the corresponding pre-programmed 0 through 9 status condition key. If no status has been programmed for the selected number key, the radio will display **NO ENTRY**. A valid selection will permit the status condition to appear in the top line of the display and the status ID to appear in the second line of the display for a pre-programmed time.

After the time-out expires or the **[M]** key has been pressed (the **[M]** key will override the time-out period), the status is selected and will be transmitted to the site or stored in the radio memory where it can be polled by the site at a future time.

View the currently selected status after it has been transmitted by pressing the **[M]** key and then the **[M]** key and then the **[⊙]** button prior to the time-out period. If the status was not sent successfully to the site, the text associated with the status condition will flash in the display.

The status selection can be changed by pressing a different status key 0 through 9, or the status operation can be cancelled by pressing Option Button 2 **[⊙]**. Both operations must be carried out prior to the time-out period.

9.25.2 Message Operation

The following method can be used to transmit a Message using the Message Operation.

1. Press the **[8 MSG]** key.
2. Press the corresponding pre-programmed 0 through 9 pre-programmed "message" key. If no message has been programmed for the selected number key, the radio will display **NO ENTRY**. A valid selection will permit the message to appear in the top line of the display and the message ID to appear in the second line of the display for a pre-programmed time.

The message selection can be changed by pressing a different message key 0 through 9, or the message operation can be cancelled by pressing Option Button 2 **[2]**. Both operations must be carried out prior to the pre-programmed time-out period.

9.26 DYNAMIC REGROUP OPERATION

Dynamic Regroup Operation permits multiple talk groups (up to eight) to be added to a radio via the system manager. The radio must be pre-programmed to respond to regrouping. Dynamic regrouping will not be activated in a radio until the system manager sends an activation message. Each radio that receives and acknowledges the regrouping instructions is successfully regrouped.

Pressing and holding the **[2]** button for 2.5 seconds toggles the user into and out of the dynamic regroup groupset. A double beep will sound for entry or exit. The display will indicate **REGRP_0x** where "x" is a digit of 1 to 8 indicating the group (when dynamic regroup has been enabled by the user). If the radio is in dynamic regroup and the user selects a group that has not been regrouped, the display will show **NO ENTRY**. The radio will be prevented from transmitting and receiving calls in this condition except for scanned groups.

After the time-out expires or the **[M]** key has been pressed (the **[M]** key will override the time-out period), the status is selected and will be transmitted to the site or stored in the radio memory where it can be polled by the site at a future time.

9.26.1 Emergency Operation

If the pre-programmed groupset on the currently selected system contains an EMER/HOME group and the radio is in dynamic regroup, the radio will declare the emergency on the currently selected dynamic group.

9.27 MACRO KEY OPERATION

Macro key operation permits the user to accomplish a series of keystrokes with a single "macro" keystroke. Each Macro Key is capable of executing up to twenty (20) keystrokes, to any push button input (i.e., keypad keys, OPTION buttons, etc.). Each macro key can be pre-programmed to activate when pressed or when released.

A macro key may also be pre-programmed to change the key stroke sequence the next time the macro key is activated.

For detailed operation and assignment of macro keys, contact your communications supervisor or administrator.

9.28 PORTABLE DATA

The P5300 series portable radios, when operating in the EDACS Trunked configuration, permit both voice and data calls to be transmitted and received. The radio can handle only one type of call at a time;

however, either data or voice is selected transparently by the operator through normal usage of the radio. Data communications is not supported in conventional mode.

The radios can be connected to a Mobile Data Terminal (MDT) or to a host computer. Any RS-232 compatible device that supports the Radio Data Interface (RDI) protocol (Version 1.91 or greater) may be connected to the radio. Support for MDTs or host computers is a programmable option per radio. Additionally, radios may also be programmed for data only operation (no voice calls transmitted or received).

9.28.1 Displays

The following will be displayed during the various states of data mode of operation:

- TX DATA** Appears on top line of display when the radio is transmitting a data call.
- RX DATA** Appears on top line of display when the radio is receiving a data call.
- DATA OFF** Appears on top line of display when the radio is in the data disabled state.
- DATA ON** Appears for two seconds on top line of display when the radio is toggled to the data enabled state.

9.28.2 DATA OFF Operation

The radio can be placed in the data disabled state by any of the following methods. When the data state is disabled, **DATA OFF** appears on the top line of the display.

- Declaring an emergency (not to be used unless an actual emergency condition exists). Alert tone will sound.
- Pressing Option Button 1 \bigcirc (if pre-programmed as “no data” key). Alert tone will sound.
- Pressing the pre-programmed “no data” (ND) key. Refer to previous bullet.

9.28.3 DATA ON Operation

The data state is enabled by one of the following (depending on how it was disabled). **DATA ON** will appear on the top line in the display for two seconds then the display will return to normal.

- Pressing the pre-programmed “no data” (ND) key toggles data state ON or OFF.
- Clearing an emergency. *This is valid only if the emergency caused “DATA OFF” operation.*



9.28.4 Exiting Data Cells

Under normal conditions, the radio enters the scan lockout mode and returns to the control channel after completion of a data call (transmit or receive). If, during a data call, one of the following operations occurs, the data call is immediately terminated and the radio performs the desired function:

- If the PTT is activated.
- If an Emergency is declared by pressing the pre-programmed emergency button.
- If a group or system is changed.

9.28.5 Scan Lockout Mode

Following the transmission or reception of a data call, if scan is enabled, scanning will stop temporarily. There are two independent pre-programmed times associated with this mode; one after a received data call and one after a transmitted data call. During this time the scan indicator will flash to indicate that scan is enabled but temporarily suspended. This condition typically returns to normal scan operation when the pre-programmed time expires; however, the following operations and conditions will terminate the scan lockout mode before the timeout has expired.

- Press the  button.
- Press the PTT.
- Change a group or system.
- Enter Telephone Interconnect mode.
- Enter Individual call mode.
- Receive a new emergency assignment.
- Declare or clear an emergency.
- Receive an individual or phone call.
- Receive an Agency, Fleet, or System All Call.
- Press  (P5350 model) or  (P5370 model) to toggle Scan ON or OFF.

9.28.6 Data Lockout Mode

During the voice call scan hang time (pre-programmed) the radio will not receive data calls.

This page intentionally left blank

CONVENTIONAL OPERATION

10 CONVENTIONAL OPERATION

The radio functions in the conventional mode when using conventional communications channels (non-trunked).

10.1 CONTROLS

The radio features two rotary control knobs and an emergency button mounted on the top of the radio. Push-To-Talk and option buttons are mounted on the side. The front mounted keypad has six buttons on the P5350 Scan model and 15 buttons on the P5370 System model.

10.1.1 Buttons and Knobs

This section describes the primary function of the button and knob controls. Other functions associated with these controls are detailed in later sections.

POWER ON-OFF VOLUME KNOB

Applies power to and adjusts the receiver's volume. Rotating the control clockwise applies power to the radio. A single alert tone (if enabled through programming) indicates the radio is operational.

Rotating the control clockwise increases the volume level. Minimum volume levels may be programmed into the radio to prevent missed calls due to a low volume setting. While adjusting the volume the display will momentarily indicate the volume level (i.e. **VOL=31**). The volume range is from a minimum programmed level of zero (displayed as **OFF** in the display) up to 31, which is the loudest level.

CONTROL KNOB

Selects systems or group/channels (depending on programming). This is a 16-position rotary knob.

Note: A mechanical stop, which can limit the positions accessed, is shipped with the radio but must be installed. To install the mechanical stop, remove the voice group selection knob, loosen the set screw on the voice group selection knob metal base (using a 1.27mm hex wrench), and remove the voice group selection knob metal base. Replace the 16 channel ring with the channel stop ring located at the desired channel. Re-install the voice group selection knob metal base, tighten the set screw, and re-install the voice group selection knob.

EMERGENCY/ HOME BUTTON

Automatically selects the pre-programmed Group/System by pressing and holding for a programmed duration. It can also be used to declare an emergency by pressing and holding for a programmed duration. The button must be pre-programmed for either operation, but not both.

PTT BUTTON

Push-To-Talk must be pressed before voice transmission begins.

SIDE OPTION BUTTON 1

Unsquelsches the receiver and allows channel monitoring prior to transmission. Momentarily removes the Channel Guard decoding from the channel.

SIDE OPTION BUTTON 2

Activates one of a number of programmable software options selected during PC programming. Programmable options include hi/low power settings, keypad lock, LCD contrast, and LCD and keypad back lighting.

10.1.2 Keypad

The keys on the keypad have special functions and are labeled using a symbol or abbreviated word describing its primary function. Numeric entry is a secondary function of the keys. Each key is described in the following subsections.

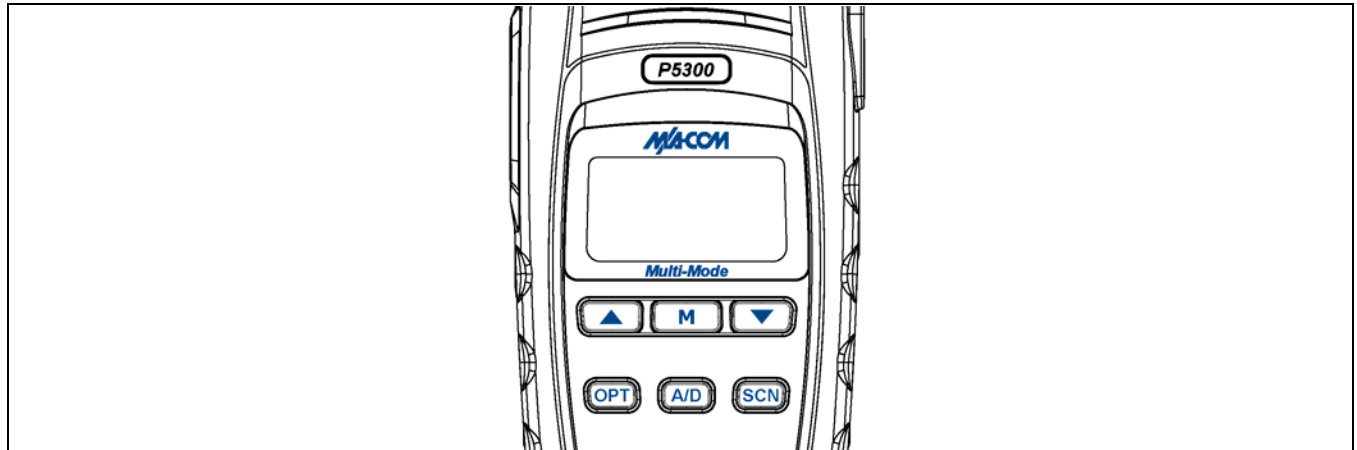

Figure 10-1: P5350 “Scan” Radio Front Panel



















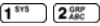

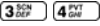

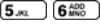

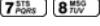

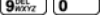

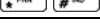
KEY	FUNCTION
 	<p><u>Primary Function:</u> Allows the user to scroll through available systems, groups, or channels, depending on personality programming.</p> <p><u>Secondary Function:</u> Changes the selection for an item within a list.</p>
	<p><u>Primary Function:</u> Accesses the pre-stored menu.</p> <p><u>Secondary Function:</u> Activates a selected item within a list. This is similar to an “Enter” key.</p>
	Adds/Deletes selected groups or channels from the Scan list of the currently selected system.
	Turns the Scan operation ON and OFF.
	Activates one of a number of programmable software options.



Figure 10-2: P5370 “System” Radio Front Panel

KEY	FUNCTION
 	<p><u>Primary Function:</u> Allows the user to scroll through available systems, groups, or channels, depending on personality programming.</p> <p><u>Secondary Function:</u> Changes the selection for an item within a list.</p>
	<p><u>Primary Function:</u> Accesses the pre-stored menu.</p> <p><u>Secondary Function:</u> Activates a selected item within a list. This is similar to an “Enter” key.</p>
           	<p><u>Primary Function:</u> Refer to the separate key definitions within this table.</p> <p><u>Secondary Function:</u> These keys function much as a typical DTMF telephone pad 0-9, *, and # keys; and are used to place telephone interconnect and individual (unit-to-unit) calls.</p>
	<p>Selects a specific system. If the rotary knob is programmed to select the system and more than 16 systems are programmed in the radio, the  key is used to select additional banks (groupings) of systems.</p>
	<p>Selects a specific group.</p>
	<p>Turns the Scan operation ON and OFF.</p>
	<p>Adds groups or channels from the currently selected system to the Scan list.</p>
	<p>Deletes selected groups or channels of the currently selected system from the Scan list.</p>
	<p>Places telephone interconnect calls.</p>
	<p>Initiates individual calls.</p>

10.2 DISPLAY

The radio display is made up of 3 lines (see Figure 10-3). Lines 1 and 2 contain eight alphanumeric character blocks and are used primarily to display system and group names. Line 1 also displays radio status messages. The 3rd line is used primarily to display radio status icons. All three lines are used to display menu options when in the menu mode. If programmed, the display backlighting will illuminate upon power up or when radio controls are operated.

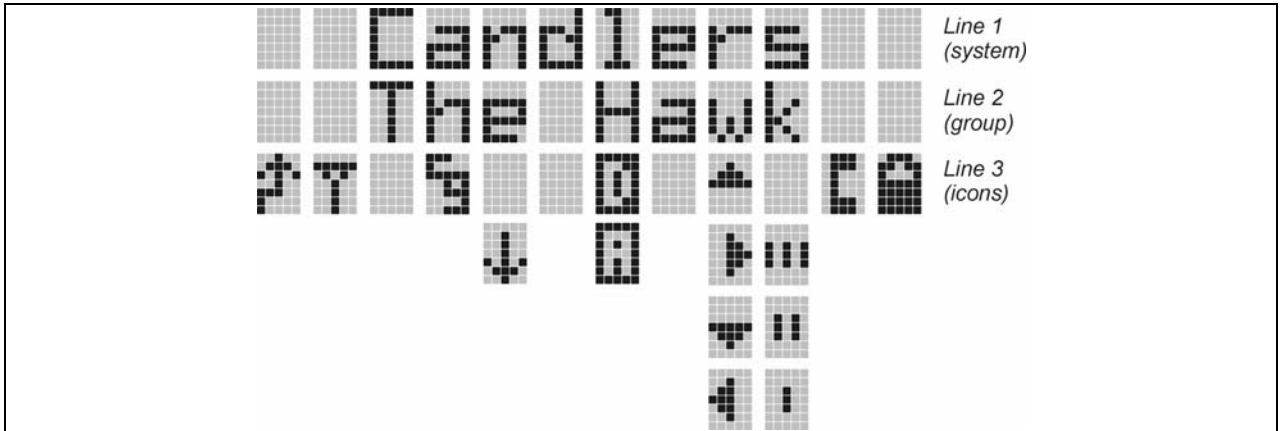





Figure 10-3: Radio Display

10.2.1 Radio Status Icons

Status Icons indicate the various operating characteristics of the radio. The icons show operating modes and conditions and appear on the third line of the display (see Table 10-1).

Table 10-1: Display Descriptions

	Steady – “Busy” transmitting or receiving. Appears in the 2nd position of the display.
	Steady – special call mode (telephone). Appears in the 11th position of the display.
	Steady – during all radio transmissions. Appears in the 1 st position of the display.
	Steady – transmit at low power. Appears in the 5th position of the display. If icon is not visible – transmit at high power
	Steady – battery charge indicator (refer to Figure 10-4). Appears in the 12th position of the display. Flashing – Low battery indicator (refer to Figure 10-4).
	Steady – Indicates the current channel is set up as an analog channel. Appears in the 7th position of the display.
	Steady – group or channel in scan list. Appears in the 10th position of the display.
	Steady – priority 2 group or channel. Appears in the 10th position of the display.
	Steady – priority 1 group or channel. Appears in the 10th position of the display.

	Steady (<i>rotates clockwise</i>) – scan mode enabled. Appears in the 9th position of the display. If icon is not visible – scan is disabled
	Steady – Channel Guard enabled. Appears in the 4th position of the display. If icon is not visible – Channel Guard is disabled
	Steady – Indicates the current channel is set up as a ProVoice or Aegis channel. Appears in the 7th position of the display.

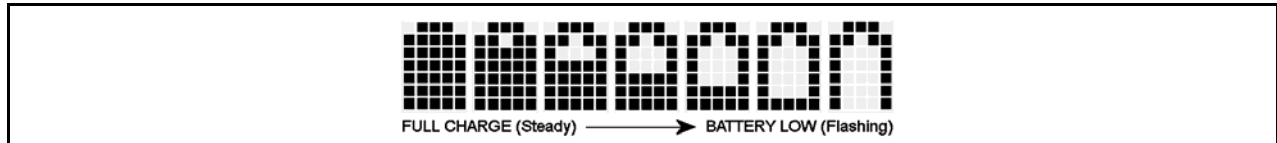

Figure 10-4: Battery Charge Icons (Full Cycle)

The battery icons (see Figure 10-4) indicate approximate level only, based on battery voltage.

10.3 TRI-COLOR LED

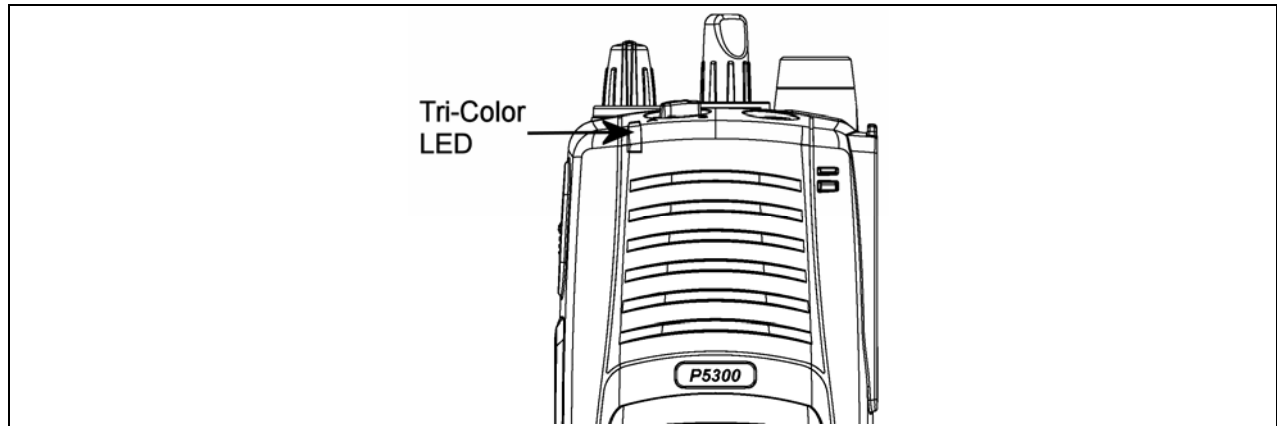

Figure 10-5: Tri-Color LED

The Tri-Color LED changes color to indicate radio status and is visible from both the front and top of the radio (see Figure 10-5). The colors of the LED and the status they represent are:

- Green: Receiving
- Red: Transmitting

If the LED is flashing rapidly, the radio is receiving an emergency call. If the LED is flashing every ½ second, the selected talk group is in the emergency state (although not transmitting). If the selected talk group is in the emergency state, an asterisk will be displayed next to the talk group name.

10.4 STATUS MESSAGES

During radio operation, various radio Status Messages can be displayed. The messages are described below.

MESSAGE	NAME	DESCRIPTION
TALKARND	Talkaround	Indicates the radio is operating on conventional channels in talkaround mode (no repeater).
LOW BATT	Low Battery	Battery voltage has dropped to the point to where the radio is no longer able to transmit. The radio will still receive calls until the battery is discharged beyond the point of operation at which time the radio will automatically shutdown.
VOL=31	Volume Level	Indicates the current volume level. The volume level display ranges from OFF (silent) to 31 (loudest).

10.4.1 Error Messages

If either of the Error Messages shown below is displayed, the radio is programmed incorrectly or needs servicing.

```
DSP ERR    or    DIG U
ERR=XXXX   ERR
(PowerUp
only)
```

Where: `xxxxx` is the error code and `DSP ERR` or `DIG U ERR` is the message.

10.5 ALERT TONES

The P5300 radio provides audible Alert Tones or “beeps” to indicate the various operating conditions (see Table 10-2).

Table 10-2: Alert Tones







NAME	STONE	DESCRIPTION
Call Originate	one short mid-pitched	<i>OK to talk after pressing the push-to-talk button</i>
Carrier Control Timer	five high-pitched / one long low-pitched	<i>PTT depressed for maximum length of time</i>
Low Battery	one low-pitched / one short mid-pitched	<i>Low battery</i>
TX Low Battery Alert	one low-pitched	<i>After PTT - battery too low to transmit</i>

10.6 TURNING ON THE RADIO

1. Power ON the radio by rotating the POWER ON-OFF/VOLUME knob clockwise. A short alert signal (if enabled through programming) indicates the radio is ready to use. Refer to Figure 7-2 for location of the POWER ON-OFF/VOLUME KNOB.
2. The display shows the last selected system and group or a default system and group (depending on programming).



3. Adjust the POWER ON-OFF/VOLUME knob to the desired volume level.
4. Select the desired system and group. The display indicates the current system and group names.
5. The radio is now ready to transmit and receive calls.

10.7 SYSTEM SELECTION

- METHOD 1:** From the control knob: If system selection is programmed to the SYSTEM/GROUP/CHANNEL SELECTION control knob, select a system by turning the knob to the desired system number position (1-16). The display registers the new system name on line one. The  button can be programmed to provide access to a “2nd bank” of 16 system number positions (17-32).
- METHOD 2:** From the keypad: If system selection is programmed as the primary function of  and , select a system by pressing  or  to scroll through the system list. The display registers the new system name on line one.
- METHOD 3:** **(P5370 model radios only)** Direct Access: Press  to enter the system select mode. Press the numeric key, which is mapped to the desired system. Press . The radio will move to the selected system.





NOTE

If system selection is programmed to the Voice group selection knob, direct access to systems will not be available. Pressing  or  will scroll through different sets of 16 systems each (banks) if more than 16 systems are programmed into the radio. The systems within each bank are then selectable via the Voice group selection knob as described previously in METHOD 1.

Example:

System: 1 = North	Group: 1 = Group 1
2 = South	2 = Group 2
3 = East	3 = Group 3
4 = West	4 = Group 4





Press . (South is the currently selected system.)

Press . (Press 4 to select “West” system.)

Press . (West is the newly selected system.)

10.8 GROUP/CHANNEL SELECTION

Several methods can be used to select a new group or channel.

- METHOD 1:** From the control knob: If group selection is programmed to the Voice Group Selection knob, select a group by turning the Voice Group Selection knob to the desired group number position. The display registers the new group name on line two. If the knob is moved to a position greater than the number of programmed groups, the highest programmed group will remain selected. The  button can be programmed to provide access to a “2nd bank” of 16 group number positions (17-32)
- METHOD 2:** From the keypad: If group selection is programmed as the primary function of  and , select a group by pressing  or  to scroll through the group list. The display registers the new group name on line two.

METHOD 3: (P5370 model radios only) Direct Access: Press **[2^{SEC}]** to enter the group select mode. Press the numeric key mapped to the desired group. Press **[M]**. The radio will move to the selected group.

10.9 MODIFY SCAN LIST

10.9.1 P5370 Model

1. Press **[3^{SCN}]** to toggle scan OFF and verify  is **not** displayed.
2. Select group or channel.
3. Press **[9^{DEL}]** once to remove group or channel from list.
4. Press **[6^{ADD}]** once to add as a normal group or channel.
5. Press **[6^{ADD}]** twice to add as a Priority 2 group.
6. Press **[6^{ADD}]** three times to add as a Priority 1 group.
7. Press **[3^{SCN}]** to re-start scanning.

10.9.2 P5350 Model

1. Press **[SCN]** to toggle scan OFF and verify  is **not** displayed.
2. Select group or channel.
3. Press **[A/D]** once to remove group or channel from the list.
4. Press **[A/D]** once to add as a normal group or channel.
5. Press **[A/D]** twice to add as a Priority 2 group.
6. Press **[A/D]** three times to add as a Priority 1 group.
7. Press **[SCN]** to re-start scanning.

10.10 NUISANCE DELETE

A channel can temporarily be deleted from the scan list, if it is not the currently selected channel, by pressing the **[A/D]** key (P5350 model) or the **[9^{DEL}]** key (P5370 model) during scan operation while the radio is displaying the unwanted channel. The channel will be deleted from the scan list in the same manner as if done using the steps above. Deletions done in this manner will not remain deleted if the radio is powered OFF and then powered ON.





10.11 BACKLIGHT ON/OFF

1. Press **[M]** to access the menu.
2. Press **[▼]** or **[▲]** to scroll through menu until "BCKLGHT" appears.
3. Press **[M]** to select Backlight menu.
4. Press **[▼]** or **[▲]** to toggle backlight ON and OFF.
5. Press **[M]** to select new backlight setting.

10.12 CONTRAST ADJUST

1. Press **M** to access the menu.
2. Press **▼** or **▲** to scroll through menu until “CONTRAST” appears.
3. Press **M** to select Contrast menu.
4. Press **▼** or **▲** to adjust contrast setting from 1 - 4.
5. Press **M** to select new contrast setting.

10.13 DECLARING AN EMERGENCY

1. Press and hold the red Emergency/Home button (the length of time is programmable; check with the system administrator).
2. ***TXEMER*** will flash in the display, plus  and  will be displayed. After 2-3 seconds the transmit icon  will turn off.
3. ***TXEMER*** and  will remain until the emergency is cleared.
4. Press the PTT and  will reappear.
5. Release PTT when the transmission is complete.

10.14 LOCKING/UNLOCKING KEYPAD

1. Press **M** button.
2. Within 1 second, press the Option button on the side of the radio.

10.15 HIGH/LOW POWER ADJUSTMENT

Transmit power adjustment is possible if enabled through programming. Within conventional systems, transmit power is adjustable on a per channel basis. Within EDACS trunking systems, transmit power is adjustable on a per system basis.

There are two ways to toggle between high and low power:

Using the Menu Button:

1. Press **M**.
2. Using the **▼** or **▲** key, scroll until the cursor (>) appears to the left of “TX POWER” in the display.
3. Press **M** again to toggle between High and Low power.
4. “POWER = HIGH” or “POWER = LOW” will appear momentarily on the top line of the display.

Using the Pre-Programmed Option Button:

Press the Option button. “POWER = HIGH” or “POWER = LOW” will appear momentarily on the top line of the display.

10.16 MENU

The Menu function accesses features that are not available directly from the keypad. The order and actual menu items available is configurable through programming. At radio power up, the menu item that is at the top of the menu list will always be displayed first. Subsequent access to the menu function will return the last menu item that was shown in the display and cursor position.

1. To enter the menu mode, press the **M** key.
2. Upon entering the menu selection mode, Menu options will appear in the display (see Figure 10-6).

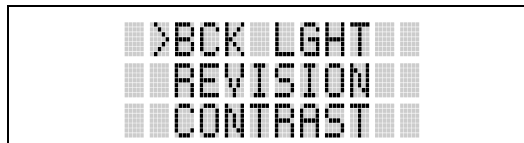

Figure 10-6: Menu Display

3. The radio will continue to receive and transmit normally while in the menu function.
4. To scroll through the menu options use the **▼** or **▲** keys. When the required menu item has been found align the cursor with the option then press **M** to select it. The menu item's parameter setting shown in the display can now be changed by using **▼** or **▲** to scroll through the list of parameter values.
5. Once the desired setting is reached press **M** to store the value and return the menu option selection level.
6. For menu items that display radio information, pressing **▼** or **▲** will scroll through a list of informational displays. The possible menu items are in Table 10-3.

10.16.1 Menu Item Selection Process

An example of the menu item selection process and menu item parameter change is shown in Figure 10-7 for the backlight menu item.

1. Press **M** to enter the menu mode.
2. Press **▼** or **▲** until the display shows:

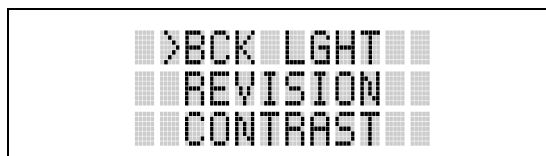

Figure 10-7: Backlight Menu Item Parameter

3. Press . The backlight menu item is activated. Line one shows the active menu item and its current parameter setting. Line two shows the currently selected system or group name (see Figure 10-8).

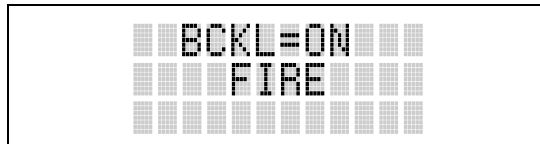

Figure 10-8: Backlight Menu Display

4. The menu item's parameter setting shown in the display can now be changed by using or .
5. Once the desired setting is reached press to store the value and return the menu option selection level.

For menu items that display radio information, pressing or will scroll through a list of informational displays. An example of information displays is shown in Table 10-4.



NOTE

The TX POWER menu item, when selected, toggles LOW/HIGH power. It does not use or to scroll nor is an additional press of the button required.

Table 10-3: Menu Item Information

FEATURE	DISPLAY	PARAMETER SETTING	COMMENT
Keypad Lock	Menu Item: KEY LOCK Once Selected: LOCKED	Locked Unlocked	Locks the keypad. To unlock; press and release M then within 1 second press the option button (<i>NOTE: this sequence is also a short cut to locking the keypad.</i>)
Backlight Adjust	Menu Item: BCK LIGHT Once Selected: BCKL=	OFF/ON	Selects the light level for backlighting.
Contrast Adjust	Menu Item: CONTRAST Once Selected: CNTRST=	1, 2, 3, 4	Selects the display contrast level.
Transmit Power Select	Menu Item: TX POWER Once Selected: POWER=	HIGH or LOW	Selects radio output power mode.
Radio Revision Information	Menu Item: REVISION	N/A	Selects the information display to view. Informational display only (see Table 10-4). <i>No user selectable settings.</i>
Toggle Scan On/Off	SCAN	ON/OFF	Toggles Scan operation ON/OFF.
Display Current Home Group/Channel	HOME	N/A	Selects Home Group/Channel
Select Desired System	SYS SEL	N/A	Selects a new system.
Add Group/Channel to Scan List	SCAN ADD	N/A	Adds to Scan List.
Delete Group/Channel	SCAN DEL	N/A	Deletes Group or Channel from Scan List.
Add/Delete Scan List	SCAN A/D	N/A	Add or Delete from Scan List.
Talkaround	TALKARND	ON/OFF	Toggles Talkaround feature ON/OFF.
Select Channel	CHN SEL	N/A	Conventional Only.
Feature Encryption Display	Menu Item: FEATURES Once Selected: (See Feature Encryption Display Section)	N/A	Indicates current features programmed into the radio as well as certain information required to add features to the radio. <i>Informational display only. No user selectable settings.</i>

Table 10-4: Information Display

RADIO ID XXXXXXXX	LID in EDACS/EA. In CONV it has no meaning.
RAM SIZ	RAM Size
FLSH SIZ	Flash Size
RF BAND	Frequency Band
PERS VER	Software Version
DSP DATE	Date DSP code was built.
DSP TIME	Time DSP code was built.
DSP FEAT	The DSP Features supported by the DSP code, in Hexadecimal. Bit mapped (see IPC spec for details): <ul style="list-style-type: none"> • 0x0001 – Conventional • 0x0002 – EDACS • 0x0010 – AMPF • 0x0020 – undefined
DSP VER	DSP Software Version
FLSH VER	FLASH Software ex: P53U0102 P=portable, 53=5300 radio, U=unencrypted, 01=major revision (>50 means unreleased code), 02=minor revision
M/A-COM (C) 2007	Copyright
PERSNLTY	Personality Name
BLD DATE	Date host (ARM) code was built.
BLD TIME	Time host (ARM) code was built.

10.17 DIGITAL VOICE OPERATION

Digital voice programmed systems have two (2) different voice modes: clear (analog) and digital. The voice modes are programmed on a per-channel basis within each conventional system.

10.17.1 Clear Mode

The Clear Mode is a voice mode in which the radio transmits and receives only clear (analog) voice signals. These analog signals are non-digitized. Clear mode transmissions can be monitored easily by unauthorized persons.



Channels programmed for clear operation cannot transmit or receive digital signals.

10.17.2 Digital Mode

The Digital Mode allows the radio to transmit and receive digitized voice signals. Digital signals provide improved weak signal performance and cannot be easily monitored with a standard receiver. Groups and channels programmed for digital operation transmit only digital signals. Individual phone calls (I-Calls) are answered back in the mode in which they were received assuming the call or hang time is still active.

Individual phone, all call, and emergency calls are transmitted clear if the digital mode is disabled or inoperative.

If receiving an analog I-Call, the radio responds in the analog mode during the hang time.

When using the ***WHC*** feature to respond to an I-Call (after the hang time has expired), the call is transmitted in the mode defined by the system mode as programmed for the current system if the ID being called is not in the I-Call list. If the ID is in the I-Call list, then the call is transmitted as defined by the I-Call mode programmed in the list for that ID.

The overdial DTMF tones are not available while in the Digital Mode.

10.17.2.1 Scanned Group Calls

Receiving a Scanned Group Call is the same as receiving a selected group call. During the scan hang time, if the radio was programmed for autoselect, it will transmit back in the same mode it received the call. For example, if a clear group is entered in the scan list, it will only receive clear calls. If the same group was available in digital and entered in the scan list, it can receive clear and digital calls, provided autoselect was programmed in the radio. The user can choose to transmit on the scanned or selected group. If a group is entered in the scan list more than once and in different modes (clear and digital), only the first occurrence of the group will be used.



Table 10-5: Transmit/Receive Mode Compatibility for Digital Voice Operation

GROUP/CHANNEL PROGRAMMING (TRANSMIT)	CLEAR RECEIVE	DIGITAL RECEIVE
CLEAR	Yes	No
DIGITAL	Yes	Yes

10.18 RECEIVING A CALL

1. Select the desired conventional system/channel or turn scan ON and make sure desired channel is in scan list.
2. When the radio receives a call, the radio will unmute and the channel name will appear in the display.

10.19 SENDING A CALL

1. Select desired system/channel.
2. Ensure the channel is not busy by pressing the  button momentarily. If audio is heard or if the  icon is on, the channel is busy.
3. When you're sure that the channel is not busy, press the PTT button and speak into the microphone.

This page intentionally left blank

***TECHNICAL ASSISTANCE
AND
WARRANTY INFORMATION***

11 TECHNICAL ASSISTANCE

The Technical Assistance Center's (TAC) resources are available to help with overall system operation, maintenance, upgrades and product support. TAC is the point of contact when answers are needed to technical questions.

Product specialists, with detailed knowledge of product operation, maintenance and repair provide technical support via a toll-free (in North American) telephone number. Support is also available through mail, fax and e-mail.

For more information about technical assistance services, contact your sales representative, or call the Technical Assistance Center at:

North America: 1-800-528-7711

International: 1-434-385-2400

Fax: 1-434-455-6712

E-mail: tac@tycoelectronics.com

12 BASIC TROUBLESHOOTING

Use Table 12-1 as a troubleshooting guide if the radio is not functioning properly. If additional assistance is required, contact a qualified service technician or call M/A-COM at 1-800-528-7711.

Table 12-1: Troubleshooting

SYMPTOM	POSSIBLE CAUSE	POSSIBLE SOLUTION
Radio will not turn on	Low battery charge	Change the battery pack to a fully charged pack.
No Audio	Speaker volume is muted.	Increase the volume level.
Poor Audio	<ul style="list-style-type: none"> • User is in a poor coverage area or not on the network. • Data cable is connected. 	<ul style="list-style-type: none"> • Move to a better coverage area. • If the data cable is connected, enter “atsprk1” to enable internal speaker.
Radio will not register or does not receive provisioning data.	Bad logon credentials.	Verify logon and password.
Screen displays: NOAUTHV	Radio authentication of the VNIC failed.	Contact system administrator.
Screen displays: NOAUTHM	VNIC authentication of the radio failed.	Contact system administrator.
Screen displays: UNAUTH3	The radio network ID has not been added to network.	Contact system administrator.
Screen displays: NOSUPRT	The voice authentication security policy is set to only allow authenticated users.	Contact system administrator.
Screen displays: BAD PWD	An invalid password has been entered.	Verify the password and re-enter.
Screen displays: OVR TEMP	The radio may be too hot. The radio will cease transmitting if an operational temperature threshold has been exceeded.	Let the radio cool before attempting to transmit. Report this failure to an authorized technician.
Radio powers off for no apparent reason.	Radio may be experiencing very low voltage.	Have the battery checked by an authorized technician.
Radio will not transmit.	Radio may be out of coverage area or may be overheated.	Return to coverage area if possible. If overheated, let radio cool before retrying transmission. Report this failure to an authorized technician.

BATTERY WARRANTY

- A. M/A-COM, Inc. (hereinafter "Seller") warrants to the original purchaser for use (hereinafter "Buyer") that nickel-cadmium and nickel-metal hydride batteries supplied by Seller shall be free from defects in material and workmanship, and shall conform to its published specifications for a period of twelve (12) months from the date of purchase.
- B. For purposes of this warranty, batteries shall be deemed defective if (1) the battery capacity is less than 80% rated capacity, or (2) the battery develops leakage.
- C. If any battery fails to meet the foregoing warranty, Seller shall correct the failure by issuing a replacement battery upon receipt of the defective battery at an Authorized Service Center (ASC) or M/A-COM factory (for OpenSky® Equipment only).
- D. Replacement batteries shall be warranted only for the remaining unexpired warranty period of the original battery. This warranty becomes void if:
1. The battery has been subjected to any kind of misuse, detrimental exposure, or has been involved in an accident.
 2. The battery is used in equipment or service other than the radio equipment for which it is specified.
- E. The preceding paragraphs set forth the exclusive remedies for claims based upon defects in or non-conformity of any battery, whether the claim is in contract, warranty, tort (including negligence), strict liability or otherwise, and however instituted. Upon the expiration of the warranty period, all such liability shall terminate. The foregoing warranties are exclusive and in lieu of all other warranties, whether oral, written, expressed, implied or statutory. NO IMPLIED OR STATUTORY WARRANTIES OF MERCHANTABILITY OR FITNESS FOR PARTICULAR PURPOSE SHALL APPLY. IN NO EVENT SHALL THE COMPANY BE LIABLE FOR ANY INCIDENTAL, CONSEQUENTIAL, SPECIAL, INDIRECT OR EXEMPLARY DAMAGES.

This warranty applies only within the United States.

M/A-COM, Inc.
1011 Pawtucket Blvd.
Lowell, MA 01853
1-877-OPENSKY

M/A-COM, Inc.
221 Jefferson Ridge Parkway
Lynchburg, VA 24501
1-800-528-7711

ECR-7048B

WARRANTY

- A. M/A-COM, Inc. (hereinafter "Seller") warrants to the original purchaser for use (hereinafter "Buyer") that Equipment manufactured by or for the Seller shall be free from defects in material and workmanship, and shall conform to its published specifications. With respect to all non-M/A-COM Equipment, Seller gives no warranty, and only the warranty, if any, given by the manufacturer shall apply. Rechargeable batteries are excluded from this warranty but are warranted under a separate Rechargeable Battery Warranty (ECR-7048).
- B. Seller's obligations set forth in Paragraph C below shall apply only to failures to meet the above warranties occurring within the following periods of time from date of sale to the Buyer and are conditioned on Buyer's giving written notice to Seller within thirty (30) days of such occurrence:
1. for fuses and non-rechargeable batteries, operable on arrival only.
 2. for parts and accessories (except as noted in B.1) sold by Seller's Service Parts Operation, ninety (90) days.
 3. for PANTHER™ Series hand portable and mobile radios, two (2) years.
 4. for all other equipment of Seller's manufacture, one (1) year.
- C. If any Equipment fails to meet the foregoing warranties, Seller shall correct the failure at its option (i) by repairing any defective or damaged part or parts thereof, (ii) by making available at Seller's factory any necessary repaired or replacement parts, or (iii) by replacing the failed Equipment with equivalent new or refurbished Equipment. Any repaired or replacement part furnished hereunder shall be warranted for the remainder of the warranty period of the Equipment in which it is installed. Where such failure cannot be corrected by Seller's reasonable efforts, the parties will negotiate an equitable adjustment in price. Labor to perform warranty service will be provided at no charge during the warranty period only for the Equipment covered under Paragraph B.3 and B.4. To be eligible for no-charge labor, service must be performed at a M/A-COM factory, by an Authorized Service Center (ASC) or other Servicer approved for these purposes either at its place of business during normal business hours, for mobile or personal equipment, or at the Buyer's location, for fixed location equipment. Service on fixed location equipment more than thirty (30) miles from the Service Center or other approved Servicer's place of business will include a charge for transportation.
- D. Seller's obligations under Paragraph C shall not apply to any Equipment, or part thereof, which (i) has been modified or otherwise altered other than pursuant to Seller's written instructions or written approval or, (ii) is normally consumed in operation or, (iii) has a normal life inherently shorter than the warranty periods specified in Paragraph B, or (iv) is not properly stored, installed, used, maintained or repaired, or, (v) has been subjected to any other kind of misuse or detrimental exposure, or has been involved in an accident.
- E. The preceding paragraphs set forth the exclusive remedies for claims based upon defects in or nonconformity of the Equipment, whether the claim is in contract, warranty, tort (including negligence), strict liability or otherwise, and however instituted. Upon the expiration of the warranty period, all such liability shall terminate. The foregoing warranties are exclusive and in lieu of all other warranties, whether oral, written, expressed, implied or statutory. NO IMPLIED OR STATUTORY WARRANTIES OF MERCHANTABILITY OR FITNESS FOR PARTICULAR PURPOSE SHALL APPLY. IN NO EVENT SHALL THE SELLER BE LIABLE FOR ANY INCIDENTAL, CONSEQUENTIAL, SPECIAL, INDIRECT OR EXEMPLARY DAMAGES.

This warranty applies only within the United States.

M/A-COM, Inc.
1011 Pawtucket Blvd.
Lowell, MA 01853
1-877-OPENSKY

M/A-COM, Inc.
221 Jefferson Ridge Parkway
Lynchburg, VA 24501
1-800-528-7711

ECR-7047C

Tyco Electronics Wireless Systems Segment

221 Jefferson Ridge Parkway

Lynchburg, Virginia 24501

(Outside USA, 1-434-385-2400) Toll Free 1-800-528-7711

www.macom-wireless.com

Printed in U.S.A.

Free Manuals Download Website

<http://myh66.com>

<http://usermanuals.us>

<http://www.somanuals.com>

<http://www.4manuals.cc>

<http://www.manual-lib.com>

<http://www.404manual.com>

<http://www.luxmanual.com>

<http://aubethermostatmanual.com>

Golf course search by state

<http://golfingnear.com>

Email search by domain

<http://emailbydomain.com>

Auto manuals search

<http://auto.somanuals.com>

TV manuals search

<http://tv.somanuals.com>