



*Échelon Series*

# Use and Care Guide

Refrigerator Drawer Model:  
2175DWRR



**2175DWRR**

**1 Introduction**

Congratulations on your purchase of a U-Line refrigeration product. A pioneer in the field for more than 40 years, U-Line Corporation is the world's number one manufacturer of built-in, under-counter, specialty refrigeration and ice making products. U-Line dedicates 100% of its research and development to these products. The result: U-Line technology consistently leads the market with innovation, design, depth of product line and performance.

U-Line products are making life more convenient in homes, businesses, and hotels around the world. U-Line supports its products with a strong dealer network, and its commitment to quality even extends to environmentally safe packaging.

**IMPORTANT**

**READ all of the instructions in this guide completely before operating the unit for the first time.**

For future reference, keep this guide in a safe, accessible location. If you need additional information or assistance, please contact U-Line Corporation directly. Contact information appears on the rear cover of this guide.

If you have a problem with the operation of this product, the SERVICE section of this guide will assist you in quickly identifying common problems and provide information on possible causes and remedies. If your product needs service, contact U-Line directly.

**Warranty Registration**

Your U-Line Corporation Limited Warranty is located on the inside rear cover of this guide. To validate your warranty, the product and its original purchase date must be registered. A Warranty Registration Card has been included for this purpose in the package containing this manual. Complete and mail the Warranty Registration Card, or register your product online at [www.U-LineService.com](http://www.U-LineService.com) as soon as possible after purchase.

If your product registration is not on file and a request for warranty coverage is received, the date of sale to the U-Line Selling Dealer or Distributor will be established as the first date of warranty coverage for your product.

**Please Record Your Model Information**

When you request additional information or service, you will be asked for your products model and serial numbers. You can find this information on the serial plate located on the upper right or rear wall in the interior of your unit. This information also appears on the warranty registration card.



**Figure 1**

Please record the model number (**Figure 1, 1**), serial number (**Figure 1, 2**), date of purchase, and dealer contact information for your U-Line product below:

**Model Number:**

\_\_\_\_\_

**Dealer Name:**

\_\_\_\_\_

**Serial Number:**

\_\_\_\_\_

**Dealer Address:**

\_\_\_\_\_

**Purchase Date:**

\_\_\_\_\_

**Dealer Telephone:**

\_\_\_\_\_

**2 Table of Contents**

---

Introduction .....2  
    Warranty Registration .....2  
    Please Record Your Model Information .....2  
Table of Contents .....3  
Safety Precautions .....5  
    Safety Alert Definitions .....5  
    General Precautions .....5  
Product Features .....6  
    Echelon Model 2175DWRR Refrigerator .....6  
Operation .....7  
    Initial Startup .....7  
    Interior Lighting .....7  
    Electronic Control Panel .....7  
    Normal Operating Sounds .....8  
    Food Storage .....9  
    Storage, Vacation, Moving .....10  
    Product Disposal .....10  
Cleaning and Maintenance .....11  
    General Cleaning .....11  
    Maintenance .....11  
Service .....13  
    Before Calling for Service .....13  
    If Service is Required .....13  
    Replacement Parts .....13  
    Troubleshooting Guide .....14  
    Electronic Control Quick Guide .....15  
U-Line Corporation Limited Warranty .....19

**This page intentionally left blank**

### 3 Safety Precautions

- **PLEASE READ** all instructions completely before attempting to install, operate, or service your unit.
- Proper installation procedures must be followed if this unit is being initially installed, or is moved to a new location after being in service. An **INSTALLATION GUIDE** for your unit, providing complete installation information is available from U-Line Corporation directly, and must be consulted before any installation is begun. U-Line contact information appears on the rear cover of this guide.
- This unit requires connection to a grounded (three-prong), polarized receptacle that has been placed by a qualified electrician in accordance with applicable electrical codes.

### Safety Alert Definitions

Safety items throughout this guide are labeled with a Danger, Warning or Caution based on the risk type:

#### **DANGER**

**Danger means that failure to follow this safety statement will result in severe personal injury or death.**

#### **WARNING**

**Warning means that failure to follow this safety statement could result in serious personal injury or death.**

#### **CAUTION**

**Caution means that failure to follow this safety statement may result in minor or moderate personal injury, property or equipment damage.**

### General Precautions

Use this appliance for its intended purpose only and follow these general precautions along with those listed throughout this guide:

#### **DANGER**

**RISK OF CHILD ENTRAPMENT.** Before you throw away your old refrigerator or freezer, take off the doors and leave shelves in place so that children may not easily climb inside.

#### **WARNING**

**SHOCK HAZARD - Electrical Grounding Required.**

- Never attempt to repair or perform maintenance on the unit until the electricity has been disconnected.
- Never remove the round grounding prong from the plug and never use a two-prong grounding adapter.
- Altering, cutting of power cord, removal of power cord, removal of power plug, or direct wiring can cause serious injury, fire and/or loss of property and/or life, and will void the warranty.
- Never use an extension cord to connect power to the unit.
- Always keep your working area dry.

#### **WARNING**

The Anti-Tip Kit must be installed on this unit before it is used. Never use the drawers as steps or as a shelf to support more than the drawers' contents. Serious personal injury could occur.

#### **CAUTION**

- Use care when moving and handling the unit. Use gloves to prevent personal injury from sharp edges.
- If your model requires defrosting, **DO NOT** use any type of heater to defrost. Using a heater to speed up defrosting can cause personal injury and damage to the inner lining.

#### **IMPORTANT**

- Do not lift unit by drawer handles.
- Never install or operate the unit behind closed doors. Be sure front grille is free of obstruction. Obstructing free air flow can cause the unit to malfunction and may void the warranty.
- Failure to clean the condenser every three months can cause the unit to malfunction. This could void the warranty.
- Allow unit temperature to stabilize for 24 hours before use.
- If your model requires defrosting, never use an ice pick or other sharp instrument to help speed up defrosting. These instruments can puncture the inner lining or damage cooling unit.
- Use only genuine U-Line replacement parts. Imitation parts can damage the unit, affect its operation or performance and may void the warranty.

## 4 Product Features

### Échelon Model 2175DWRR Refrigerator

A 5.5 cu ft (156 L) built-in under counter refrigerated drawer unit

#### Features of Échelon

- An electronic control panel with digital display allows you to display the actual temperature in the drawer and adjust the temperature setting to your personal preference. The electronic control and digital display provide an attractive appearance, and its method of control provides precise temperature settings.
- An interior light will illuminate automatically in each drawer as it is opened.  
**NOTE:** A blackout/Sabbath mode (not Star K certified) allows you to darken both interior lights and the LED display, while maintaining complete temperature control in the unit.
- Automatic (cycle) defrost means maintenance-free defrosting.
- Multiple organizing features, allowing you to customize your refrigeration space, include:
  - a. An adjustable Slide and Divide organizer is standard in the top drawer and can be used in either drawer. It is easily adjusted from front to back and side to side.
  - b. A clear organizing bin in the top drawer can accommodate wine bottles, two-liter bottles or other items. The bin is designed to slide from the front to rear of the drawer allowing easy access to items in or beneath the bin.
  - c. A bottom drawer crisper can be removed from either side of the drawer to bring fruit or vegetables to a sink, counter top or bar.
  - d. The glass crisper shelf allows the crisper contents to be easily seen. The shelf can be fully removed to accommodate storage of taller items.
- Stainless steel units feature full wrap stainless steel drawer fronts with sculpted handles.

- Stainless steel drawer interiors are corrosion-resistant and provide a sleek, professional appearance.
- Heavy duty, full extension drawer slides permit easy accessibility to contents in the back of drawers.
- All models feature a vinyl clad steel cabinet that provides a rich textured look, and resist scratching, peeling and flaking.
- Black units come standard from the factory equipped for full overlay panels. However, the drawers can accommodate custom 1/4" (0.64 cm) thick panels.  
**NOTE:** If neither full overlay nor 1/4" (0.64 cm) thick panels will be used, U-Line recommends replacing the existing handles with the replacement drawer handles (P/N 26070-01).
- The Model 2175DWRR Refrigerator cannot be configured for a free-standing installation. It must be installed as a built-in under counter unit, and be anchored to prevent tipping, using the originally provided anti-tip kit.

Features and specifications are subject to change without notice.

## 5 Operation

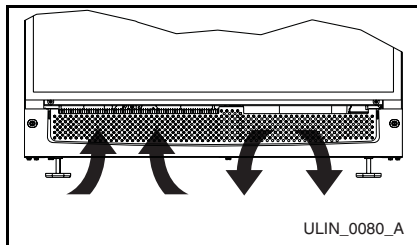

Figure 2

### IMPORTANT

**Proper air flow is required for your unit to operate at its highest efficiency. A grille, located in the base of the unit, must not be blocked at any time, or your unit will not perform as expected (Figure 2).**

## Initial Startup

All U-Line units are shipped with controls that are preset. No initial adjustments are required.

### IMPORTANT

**U-Line recommends the unit be allowed to run overnight prior to loading the refrigerator with product.**

**NOTE:** Control display is located inside top drawer.

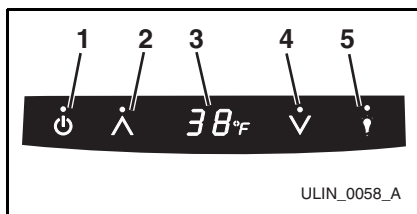

Figure 3

To turn the unit on or off, touch and hold the POWER icon (**Figure 3, 1**) on the display panel for approximately ten seconds until the °F symbol flashes and release.

- A small LED above the icon will illuminate to confirm the touch of any controller icon.
- The display (**Figure 3, 3**) will show the unit set-point temperature (38°F) when the unit is on and will show OFF when the unit is off.
- Turning the unit off will override any other control function.

## Interior Lighting

The interior drawer lights are controlled by individual switches on each drawer. As a drawer is opened, the light will go "ON." The light will go "OFF" when the drawer is closed.

The LIGHT icon (**Figure 3, 5**) on the control panel is used to control an additional lighting function. The blackout/Sabbath mode (not Star K certified) will turn the interior lights and display (**Figure 3, 3**) off for a preset 36-hour period.

To access the blackout/Sabbath mode (not Star K certified):

1. Touch and hold the LIGHT icon (**Figure 3, 5**) for ten seconds and release (the °F symbol will flash briefly at the end of the ten second period).
2. The interior light and control display (**Figure 3, 3**) will go dark for the next 36 hours.

**NOTE:** Although the display will not be visible, the temperature controls in the unit remain active and the interior temperature will be maintained.

3. To exit the blackout/Sabbath mode (not Star K certified) manually at any time, repeat Step 1.

## Electronic Control Panel

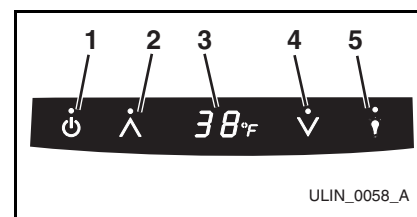

Figure 4

The electronic control with digital display (**Figure 4**) is configured to show a single temperature continuously. This set-point temperature is a base number used by the controller to maintain the temperature zone in your unit. The factory default set-point is 38°F. This set-point temperature is used as a gauge if further temperature adjustments are required.

### Temperature Display Selection

U-Line products supplied for 110 VAC operation have temperatures displayed in a default Fahrenheit (°F) configuration (**Figure 4, 3**). Models supplied for 220 VAC operation have temperatures displayed in a default Celsius (°C) configuration.

The display can easily be adjusted for either type of temperature display. Press and hold the LIGHT icon (**Figure 4, 5**) and within five seconds press the COOLER icon (**Figure 4, 4**) three times to change the display as desired.

## Temperature Display

To display the interior temperature:

1. Touch and hold the WARMER icon (**Figure 4, 2**) for approximately five seconds and release when the °F symbol in the display (**Figure 4, 3**) begins to flash.
2. The display (**Figure 4, 3**) will indicate the actual refrigerator temperature.
3. After approximately 10 seconds, the set-point temperature will return to the display.

Factors which affect the internal temperatures of the cabinet include:

- Temperature setting.
- Ambient temperature where installed.
- Number of times and length of time the door is opened and closed.
- Installation in direct sunlight or near a heat source.

## Adjusting Temperature

### IMPORTANT

**Adjust the set-point temperature in single increments, and wait 24 hours for the temperature to stabilize before rechecking.**

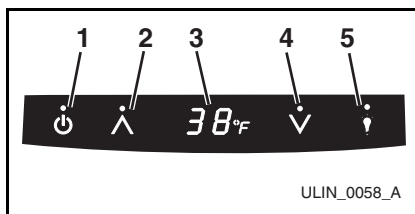

**Figure 5**

To adjust the set-point temperature:

1. Press and release either the WARMER (**Figure 5, 2**) or COOLER (**Figure 5, 4**) icon to put the controller in the SET TEMPERATURE mode. The °F symbol (**Figure 5, 3**) will begin to flash.

**NOTE:** If no further action is taken, this mode will self cancel in five seconds and the original set-point temperature will be displayed.

2. While the °F symbol is flashing, press the WARMER or COOLER icon as required to adjust the set-point temperature.
3. The change will be set five seconds after adjusting the temperature and the new set-point temperature will be displayed.

## Normal Operating Sounds

All models incorporate rigid foam insulated cabinets to provide high thermal efficiency and maximum sound reduction for its internal working components. In spite of this technology, your model may make sounds that are unfamiliar.

Normal operating sounds may be more noticeable because of the unit's environment. Hard surfaces such as cabinets, wood/vinyl/tiled floors and paneled walls have a tendency to reflect normal appliance operating noises.

Common refrigeration components, and a brief description of the normal operating sounds they make, are listed below. **NOTE:** Your product may not contain all of the components listed.

- Compressor: The compressor makes a hum or pulsing sound that may be heard when it operates.
- Evaporator: Refrigerant flowing through an evaporator may sound like boiling liquid.
- Condenser Fan: Air moving through a condenser may be heard.
- Automatic Defrost/Drain Pan: Water may be heard dripping or running into the drain pan when the unit is in the defrost cycle.



## Food Storage

### Drawers

The drawers should only be removed for servicing by a trained and certified repair person.

### Top Storage Bin

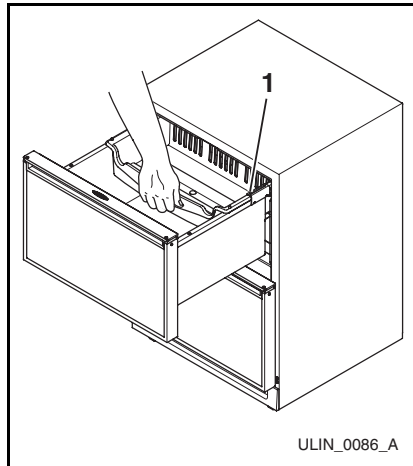

**Figure 6**

Grasp the bin handle and slide backward to access the contents below (**Figure 6**). The bin may be completely removed for cleaning once it is slid forward, making sure it clears the guides on each side of the drawer. Then lift straight up. If heavy items are stored in bin, push front of bin down slightly while sliding. Slide bin forward, especially with heavy items, to ensure that drawer closes completely.

### Crisper

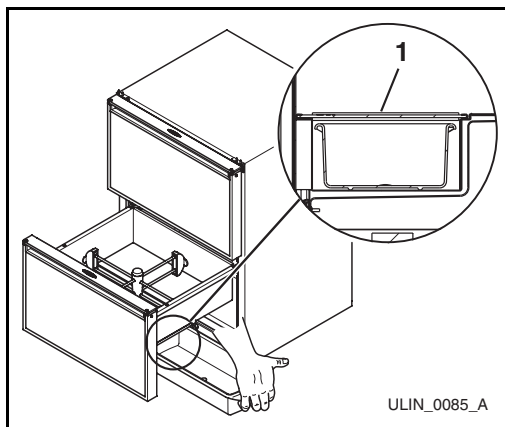

**Figure 7**

To access the crisper, open the bottom drawer fully. Grasp the handle to either side of the crisper (**Figure 7**) and slide just enough to access the contents. To remove crisper, support both ends and slide out completely. To remove the glass crisper cover (**Figure 7, 1**), remove the crisper and push up on cover from bottom.

### CAUTION

**When opening or closing the crisper, pull or push slowly and carefully. If the crisper is pulled out too far or pushed in too hard, it could come out all the way and possibly cause product damage or personal injury.**

### Drawer Organizer

Adjust the drawer organizer to compensate for different sized bottles or items. The organizer can be used in either drawer, but is shipped from the factory in the top drawer.

An accessory organizer (U-Line P/N 80-48001-00) can be purchased to keep both drawers organized.

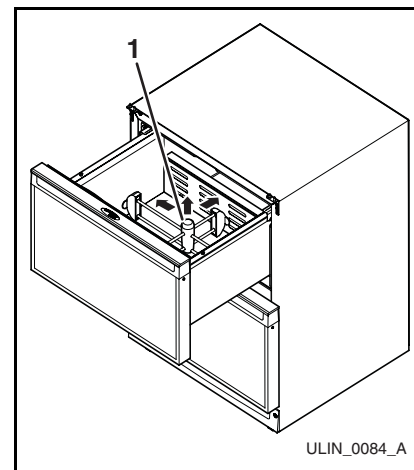

**Figure 8**

The organizer may be adjusted left-to-right or front-to-back as required. When adjusting the organizer, open the drawer fully, remove all items, and brace the drawer to prevent movement. To adjust, turn the drawer organizer knob (**Figure 8, 1**) counterclockwise to loosen and use two hands to position as desired. Tighten knob after adjustment is made. Do not over-tighten.

Clean the drawer organizer with warm water and a mild detergent only. Do not use solvent-based or abrasive cleaners and do not place the drawer organizer in a dishwasher.

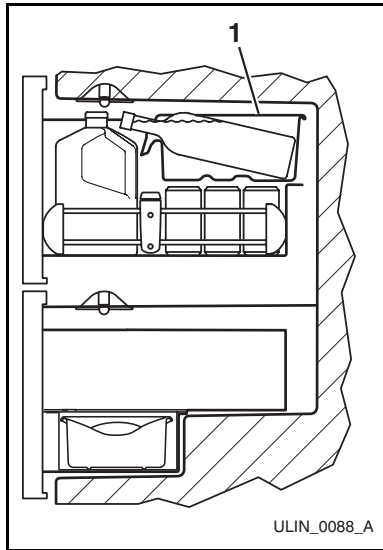

**Figure 9**

Be sure that items stored in the rear of the top drawer do not interfere with the sliding operation of the storage bin. Tall items such as milk jugs can be stored toward the front of the drawer as long as they do not interfere with the closing of the drawer. Taller items can be stored on their side (**Figure 9, 1**) in the storage bin.

The storage bin is designed to accommodate the storage of two wine bottles, even when opened.

Place the bottle in the bin so that the neck of the bottle rests on the front lip of the bin.

## Storage, Vacation, Moving

If the unit will not be used for an extended period, or otherwise stored, follow these steps completely:

### **⚠ WARNING**

**Electrical Shock Hazard. Disconnect power before servicing. Before operating, replace all panels. Failure to do so may result in death or electrical shock.**

1. Remove all consumable contents from the unit.
2. Disconnect the power cord from its outlet, and leave it disconnected until the unit is returned to service.
3. Clean and dry the interior of the cabinet (See **CLEANING AND MAINTENANCE: GENERAL CLEANING**).
4. During periods of non-use, the cabinet must remain open to prevent the formation of mold and mildew. Open door a minimum of 2 in. (5 cm) to provide the necessary ventilation.

## Product Disposal

If the unit is being removed from service for disposal, check and obey all Federal, State and/or Local regulations regarding the disposal and recycling of refrigeration appliances, and follow these steps completely:

1. Remove all consumable contents from the unit.
2. Disconnect power to the unit and unplug the power cord from its outlet.

### **⚠ DANGER**

**RISK OF CHILD ENTRAPMENT. Before you throw away your old refrigerator or freezer, remove the drawers.**

3. Remove the drawers from the unit, and secure all shelving and accessories to the interior of the unit using a heavy duty cloth or package sealing tape.

## 6 Cleaning and Maintenance

### General Cleaning

#### Exterior Cleaning (As Required)

##### Black Models:

- Surfaces may be cleaned with a mild detergent and warm water solution. Do not use solvent-based or abrasive cleaners. Use a soft sponge and rinse with clean water. Wipe with a soft, clean towel to prevent water spotting.

##### Stainless Steel Models:

- Stainless steel surfaces and components can discolor when exposed to chlorine gas, pool chemicals, salt water or cleaners with bleach.
- Keep your stainless steel unit looking new by cleaning with a good quality all-in-one stainless steel cleaner/polish on a monthly basis. For best results use Claire® Stainless Steel Polish and Cleaner, which can be purchased from U-Line Corporation (P/N 173348). Comparable products are acceptable. Frequent cleaning will remove surface contamination that could lead to rust. Some installations may require cleaning on a weekly basis.
- Do not clean with steel wool pads.**
- Do not use cleaners that are not specifically intended for stainless steel on stainless steel surfaces (this includes glass, tile and counter cleaners).**
- If any surface discoloring or rusting appears, clean it quickly with Bon-Ami® or Barkeepers Friend Cleanser® and a non-abrasive cloth. Always clean in the direction of the grain. Always finish this process with Claire Stainless Steel Polish and Cleaner or comparable product to prevent further problems.
- Using abrasive pads such as Scotchbrite™ will cause the graining in the stainless steel to become blurred.**
- Rust that is not cleaned up promptly can penetrate into the surface of the stainless steel and complete removal of the rust may not be possible.

#### Interior Cleaning (As Required)

- Disconnect power to the unit. Clean the interior and all removed components using a mild non-abrasive detergent and warm water solution applied with a soft sponge or non-abrasive cloth. Rinse the interior using a soft sponge and clean water.
- Do not use any solvent-based or abrasive cleaners. These types of cleaners may transmit taste to the interior products and damage or discolor the interior.**

#### IMPORTANT

**Do not place top storage bin, drawer organizer or the crisper bin in dishwasher. Dishwasher will warp/discolor items and render them useless.**

### Maintenance

Proper maintenance of your U-Line product will ensure efficiency, top performance and long life. The maintenance intervals listed are based on normal conditions. You may want to shorten the intervals if you have pets or other special considerations.

#### Defrosting

##### Automatic (Cycle) Defrost Models

Automatic defrost models do not produce frost in normal operating conditions. However, a frost pattern may be noticed on the interior walls if the unit is repeatedly opened in a high heat or high humidity location. If this frost pattern does not clear within 24 hours, your unit will require manual defrosting.

#### ⚠ WARNING

**DO NOT use any type of electrical heating device, ice pick, knife or other sharp instrument to defrost; this could damage the inner lining or refrigeration system and void the warranty.**

#### IMPORTANT

**The drain pan was not designed to capture the water created when manually defrosting. To prevent water from overflowing the drain pan, place towels or other absorbent materials over the interior drain trough, under the evaporator (Figure 10, 1), before defrosting.**

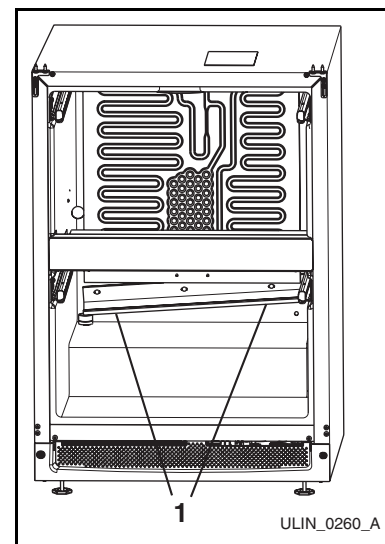

Figure 10

To defrost:

1. Turn the unit off.
2. Remove all products from the interior and leave the drawers in an open position (2" (5 cm) minimum).
3. Allow the frost to completely melt naturally. Clean the interior and all removed components using a mild non-abrasive detergent and warm water solution applied with a soft sponge or non-abrasive cloth. **NOTE: DO NOT use any solvent-based or abrasive cleaners. They will discolor or damage the interior.**
4. Dampen a soft sponge or non-abrasive cloth in clean water and wipe down the cabinet interior and removed components to remove any detergent residue. Rinse the sponge or cloth in clean water and repeat as necessary until the cabinet and components are clean.
5. When the interior is dry, turn the unit on.

### Condenser Cleaning

#### Interval - Every Three Months

To maintain operational efficiency, keep the front grille free of dust and lint and clean the condenser every three months. Depending on environmental conditions, more or less frequent cleaning may be necessary.

#### **! WARNING**

**Disconnect electric power to the unit before cleaning the condenser.**

To remove and replace the grille for access to the condenser fins, follow this procedure:

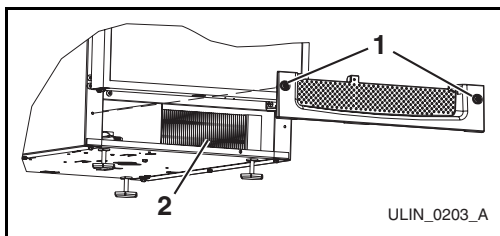

**Figure 11**

1. Disconnect electrical power to the unit.
2. Loosen two screws (**Figure 11, 1**) completely.  
**NOTE:** Screws are held in the grille by o-ring retainers, and will not come free of the grille.
3. Remove the grille.

#### **! WARNING**

**DO NOT touch the condenser fins. The condenser fins are SHARP and can be easily damaged.**

#### **! CAUTION**

**DO NOT use any type of cleaner on the condenser unit.**

4. Clean the condenser coil (**Figure 11, 2**) using a soft brush with a "combing" action or vacuum cleaner. Do not touch the condenser coil.
5. Position the grille to align the mounting screws with the holes in the cabinet.
6. Secure, but do not over-tighten both grille screws.
7. Reconnect power to the unit.

### Leveling

**NOTE:** It is recommended that the unit is level.

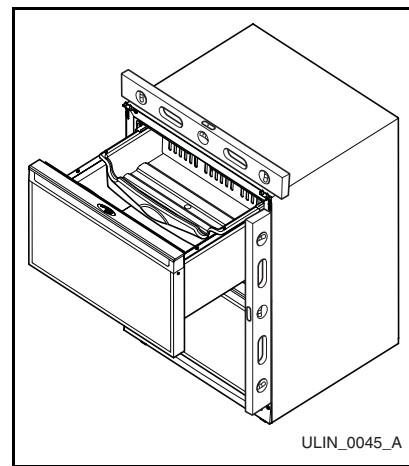

**Figure 12**

1. Use a level to check the levelness of the unit from front to back and from side to side. Place the level along top edge and side edge as shown (**Figure 12**).

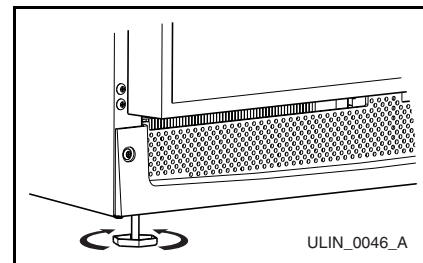
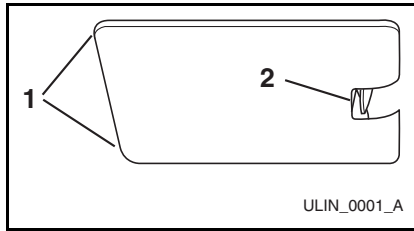

**Figure 13**

2. If the unit is not level, adjust the feet on the corners of the unit as necessary (**Figure 13**).
3. Check the levelness after each adjustment and repeat the previous steps until the unit is level.

## Light Bulb Replacement

To replace the light bulb in your U-Line unit:



**Figure 14**

1. Grasp the edges of the light housing lens (**Figure 14, 1**) opposite the exposed tab and gently push the lens toward the tab (**Figure 14, 2**).
2. Pull the edge of the lens down (**Figure 14, 1**) and swing it out of the light housing.

### IMPORTANT

**ALWAYS use a genuine U-Line replacement bulb (P/N 31317) in the light housing. Use of any other bulb within the housing will generate excessive heat, causing damage to the light housing and cabinet interior, and will compromise the precise temperature control of your unit.**

3. Replace the bulb only with a genuine U-Line P/N 31317 replacement.
4. Replace the lens by first inserting the tab side back into the housing at a slight angle. While gently pushing the lens towards the tab end, push the free end up into the housing, and release when you will hear a snap/click.

## 7 Service

### Before Calling for Service

If your U-Line product appears to be malfunctioning, read through the OPERATION section of this guide to ensure that the function of all controls are clearly understood. If the malfunction persists, the TROUBLESHOOTING GUIDE in this guide will assist you in quickly identifying common problems, and provide information on possible causes and remedies. Most often, this will resolve the problem without the need to call for service.

### If Service is Required

If you do not understand a troubleshooting remedy, or your product needs service, contact U-Line Corporation directly. Contact information appears on the rear cover of this guide.

You will be asked for your product Model and Serial Numbers. This information should be recorded inside the front cover of this guide, following the products original purchase. It also appears on the Model and Serial number plate located on the upper right or rear wall of the interior of your product.

### Replacement Parts

When you need replacement parts, always request that genuine U-Line replacements be used. U-Line products have been designed and engineered using components that work efficiently, and provide superior service life and performance. The use of aftermarket parts or components may affect the safety, operation, performance or durability of your product, and may also void its warranty.

## Troubleshooting Guide



### **ELECTROCUTION HAZARD**















**Never attempt to repair or perform maintenance on the unit until the main electrical power has been disconnected.**

#### **Troubleshooting - What to check when problems occur:**

| <b>PROBLEM</b>  | <b>POSSIBLE CAUSE</b>                                    | <b>REMEDY</b>   |
|---|--|---|
| Unit does not operate and electronic display is blank.  | No electrical supply                                     | Plug unit in or check circuit breaker.  |
| No interior light   | Loose or burned out bulb                                 | Tighten or replace bulb (See MAINTENANCE; LIGHT BULB REPLACEMENT).  |
| Electronic display is blank and interior light is off with drawer open.                         | Unit is in blackout/Sabbath mode (not Star K certified). | Exit blackout/Sabbath mode (not Star K certified) (See OPERATION; INTERIOR LIGHT CONTROL).  |
| Electronic display is blank and interior light is on with drawer open.                          | A display function has changed.                          | Touch and hold the warmer temperature button and touch and release the POWER button three times, then release the temperature button. The display should become visible.  |
| Electronic display shows repeating, randomly flashing symbols and partial characters.           | A factory control mode has been inadvertently entered.   | Touch and hold the warmer temperature button and touch and release the LIGHT button three times, then release the temperature button to exit the factory control mode. The set-point temperature should now be displayed. |
| Electronic display shows: 0, 1 to 26, or 99.  | A factory control mode has been inadvertently entered.   | Repeatedly touch the warmer temperature button to advance any number shown to 99 and touch and release the LIGHT button. The set-point temperature should now be displayed.   |
| Electronic display shows E3 or E10.   | Drawer(s) open longer than 20 minutes                    | Close drawer(s) completely. The set-point temperature should now be displayed.  |
| Electronic display shows one or more of the following: E1, E2, E4, E5, E6, E7, E8, E9, E11, P1. | The unit is displaying an error code.                    | Record the error code(s) displayed and call for service.  |
| Unit not cold enough. Check temperatures (See OPERATION for approximate temperatures).          | Control set too warm                                     | Set control to a cooler setting (See OPERATION). Allow 24 hours for temperature to stabilize.   |
|   | Airflow to front grille blocked                          | Airflow must not be obstructed to front grille (See OPERATION).   |
|   | Dirty condenser coils                                    | Clean condenser (See MAINTENANCE; CONDENSER CLEANING).  |
|   | Door gasket not sealing properly                         | Door adjustment required (See MAINTENANCE; DOOR ALIGNMENT CHECK AND ADJUSTMENT).  |
|   | Item(s) interfering with drawer                          | Reposition or remove item(s).   |
|   | Inaccurate temperature reading                           | Properly check temperature (See OPERATION).   |
| Unit is too cold. Check temperatures (See OPERATION for approximate temperatures)               | Control set too cold                                     | Set control to a warmer setting (See OPERATION). Allow 24 hours for temperature to stabilize.   |
| The unit frosts up.   | High ambient temperatures or humidity                    | Defrost unit manually (See MAINTENANCE; DEFROSTING).  |
|   | Drawers not closed                                       | Close drawers and wait 24 hours. If frost has not cleared up, must manual defrost (See page 11).  |
| Noise during operation  | Certain sounds are normal.                               | Soft sounds from the fan and water/dropping sounds from the ice maker will be heard.  |
| Drawer(s) can't close.  | Item(s) interfering with drawer                          | Adjust items in drawer(s).  |
|   | Unit not level   | Make sure unit is level (See LEVELING, page 12).  |







## Electronic Control Quick Guide

### All Models





| Task                    | Touch  | Touch   | Display  | Comment   |
|-------------------------|--|---|--|---|
| Turn ON/OFF             |  Hold 10 seconds  | Release when °F flashes.  |  |   |
| Adjust Temperature      |  or  Touch and release |  or  Touch to change temperature  |  | °F flashes after first touch, set-point saved after 5 seconds of inactivity and °F stops flashing.* |
| View Actual Temperature |  Hold 5 seconds   | Release when °F flashes.  |  | For Wine Coolers, see Use and Care Manual.  |
| Change °F-°C            |  Hold   |    |  | Repeat to switch back.  |
| Blackout Mode           |  Hold 10 seconds  |   | Display (and cabinet light) not operable in Blackout Mode.                         | Hold light for 10 seconds to exit.  |

\* Drawer Wine Cooler: Initially, top bar will flash to set to zone. After five seconds of inactivity (or touching light button), the bottom zone (bottom bar on F flashing) can be adjusted. After five seconds of inactivity, set-point will be stored in unit.







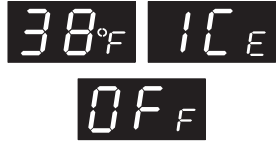







### Glass Door Models

| Task             | Touch  | Touch   | Display   | Comment   |
|------------------|--|---|---|---|
| Cabinet Light    |        |   |  | Light normally goes on/off with door opening. Pressing light button will turn interior light on for 4 hours, then it will turn off. |
| Display Off Mode |  Hold |    |   | Display off when door is closed (unless cabinet light is switched on). Repeat to switch back.                                       |

### All Ice Makers

| Task               | Touch  | Touch   | Display  | Comment               |
|--------------------|--|---|--|-----------------------|
| Ice Maker Off Mode |  Hold |    |  | Repeat to switch back |

### Clear Ice & Clear Combo Only

| Task                             | Touch  | Touch   | Display  | Comment   |
|----------------------------------|--|---|--|---|
| Clean Cycle                      |  Hold |    |  | Will automatically return to ice production when clean cycle is complete. |
| Ice Thickness Adjustment         |  Hold |    |  | Use warmer/colder to scroll.  |
| Temporary Shutdown (Office Mode) |  Hold |    |  | Ice maker will automatically turn back on in three hours.                 |

**NOTE:** 38°F is an example; the display will vary with actual set-point.

### IMPORTANT

**Factory recommended set-point is 38°F for refrigerators and beverage centers, and 50°F for wine coolers.**

**This page intentionally left blank**



**This page intentionally left blank**

**This page intentionally left blank**

## U-Line Corporation Limited Warranty

U-Line Corporation warrants each U-Line product to be free from defects in materials and workmanship for a period of one year from the date of purchase; and warrants the sealed system (consisting of the compressor, the condenser, the evaporator, the hot gas bypass valve, the dryer and the connecting tubing) in each U-Line product to be free from defects in materials and workmanship for a period of five years from the date of purchase. During the initial one-year warranty period for all U-Line products U-Line shall: (1) at U-Lines option, repair any product or replace any part of a product that breaches this warranty; and (2) for all Marine, RV and Domestic U-Line products sold and serviced in the United States (including Alaska and Hawaii) and Canada, U-Line shall cover the labor costs incurred in connection with the replacement of any defective part. During years two through five of the warranty period for the sealed system, U-Line shall: (1) repair or replace any part of the sealed system that breaches this warranty; and (2) for all Marine, RV and Domestic U-Line products sold and serviced in the United States (including Alaska and Hawaii) and Canada, U-Line shall cover the labor costs incurred in connection with the replacement of any defective part of the sealed system. All other charges, including transportation charges for replacements under this warranty and labor costs not specifically covered by this warranty, shall be borne by you. This warranty is extended only to the original purchaser of the U-Line product. The Registration Card included with the product should be promptly completed by you and mailed back to U-Line or you can register on-line at [www.U-LineService.com](http://www.U-LineService.com).

The following are excluded from this limited warranty: installation charges; damages caused by disasters or acts of God, such as fire, floods, wind and lightning; damages incurred or resulting from shipping, improper installation, unauthorized modification, or misuse/abuse of the product; customer education calls; food loss/spoilage; door and water level adjustments (except during the first 90 days from the date of purchase); defrosting the product; adjusting the controls; door reversal; or cleaning the condenser.

If a product defect is discovered during the applicable warranty period, you must promptly notify either the dealer from whom you purchased the product or U-Line at P.O. Box 245040, Milwaukee, Wisconsin 53224 or at 414-354-0300. In no event shall such notification be received later than 30 days after the expiration of the applicable warranty period. U-Line may require that defective parts be returned, at your expense, to U-Lines factory in Milwaukee, Wisconsin, for inspection. Any action by you for breach of warranty must be commenced within one year after the expiration of the applicable warranty period.

**This limited warranty is in lieu of any other warranty, express or implied, including, but not limited to any implied warranty of merchantability or fitness for a particular purpose; provided however, that to the extent required by law, implied warranties are included but do not extend beyond the duration of the express warranty first set forth above. U-Lines sole liability and your exclusive remedy under this warranty is set forth in the initial paragraph above. U-Line shall have no liability whatsoever for any incidental, consequential or special damages arising from the sale, use or installation of the product or from any other cause whatsoever, whether based on warranty (express or implied) or otherwise based on contract, tort or any other theory of liability.**

Some states do not allow limitations on how long an implied warranty lasts or the exclusion or limitation of incidental or consequential damages, so the above limitations may not apply to you. This warranty gives you specific legal rights, and you may also have other rights which vary from state to state.



For General Inquiries:

P.O. Box 245040  
Milwaukee, Wisconsin  
53224-9540 U.S.A.  
Phone (800) 779-2547  
FAX (414) 354-5696  
[www.U-Line.com](http://www.U-Line.com)

**For Service and Parts Assistance:**

Phone (800) 779-2547  
(414) 354-0300  
FAX (414) 354-5696  
Email:  
[OnLineService@U-Line.com](mailto:OnLineService@U-Line.com)  
[www.U-LineService.com](http://www.U-LineService.com)  
E-mail:  
[OnlineParts@u-line.com](mailto:OnlineParts@u-line.com)

# *Échelon Series*

For more than four decades, U-Line has distinguished itself as the leader in built-in under-counter ice making, refrigeration and wine storage appliances.

An INSTALLATION MANUAL for your unit, providing complete installation information, is available for download at [www.U-Line.com](http://www.U-Line.com). Information for custom panel inserts per model, including panel size, and instructions are available by visiting [www.U-Line.com](http://www.U-Line.com).

When you need replacement parts, always request genuine U-Line replacements be used. Visit [www.U-Line.com](http://www.U-Line.com) to locate a parts distributor in your area.

## *Échelon Series / Origins Series*

U-Line Corporation, located in Milwaukee, WI, is a family operated manufacturer of built-in undercounter ice makers, Combo® ice maker/refrigerators, Wine Captain® wine storage units, refrigerators, refrigerated drawers and refrigerator/freezers.

## Free Manuals Download Website

<http://myh66.com>

<http://usermanuals.us>

<http://www.somanuals.com>

<http://www.4manuals.cc>

<http://www.manual-lib.com>

<http://www.404manual.com>

<http://www.luxmanual.com>

<http://aubethermostatmanual.com>

Golf course search by state

<http://golfingnear.com>

Email search by domain

<http://emailbydomain.com>

Auto manuals search

<http://auto.somanuals.com>

TV manuals search

<http://tv.somanuals.com>