



Air-Powered Door Operator Installation & Maintenance Guide

2319 Laurelbrook Street, Raleigh, NC 27604 Phone (800)542-7221 Fax (919)834-4526

Air-Powered Door Operator Installation Guide

This is an installation guide for the Air-Powered Door Operator. It is a general guideline for a normal installation. If problems arise call (800)542-7221 for specific advice.

Necessary tools:

Drill and 1/4" bit (to drill mounting holes in operator bracket and door track)
2 vise-grips
Set of Allen wrenches
Set of open-end wrenches — 1/4" to 9/16"
Set of screwdrivers — flat head and Phillips
Set of sockets — 1/4" to 9/16"
Impact wrench
3/8" drill — cordless or electric
2-foot level
Masonry drill — 1/2" or 3/8" bit
Saw saw

Supplies needed but not included with this kit:

Track bolts to mount operator to track
Air compressor
Fasteners to mount controls to walls

Note: Inspect door for smooth rolling and proper balancing before installing Air Powered Operator.

Part 1:BELT INSTALLATION

Step 1

Determine which side of door to install the air powered operator. 6" of shaft is required beyond track bracket.

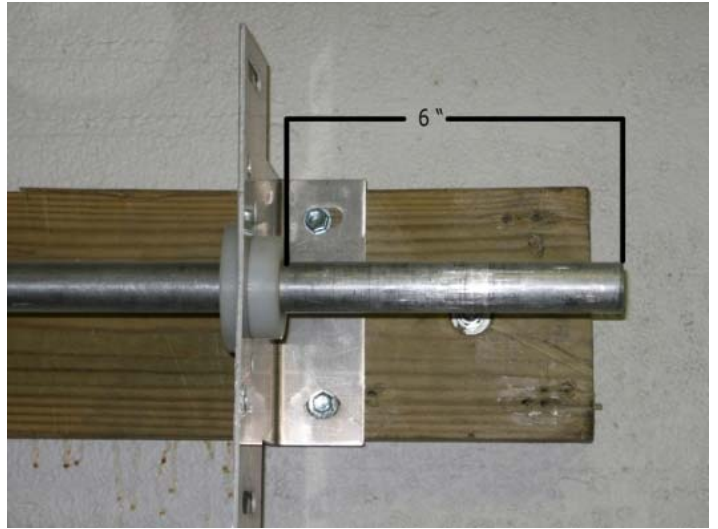

Clearance Requirements

8" of side clearance is required to mount operator.

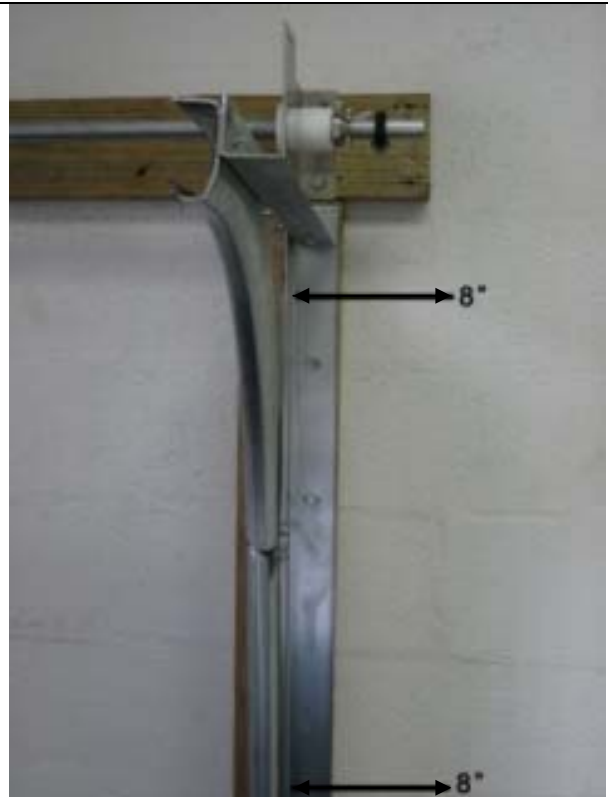

Step 2 Installing Sprocket Kit

Position the 1½" spacer (Part No. SP101) onto the shaft against the bearing as shown.

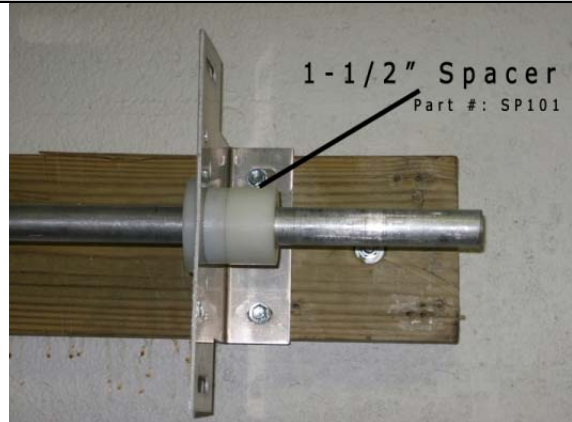

Next slide the sprocket (Part No. BSP01) against the spacer.

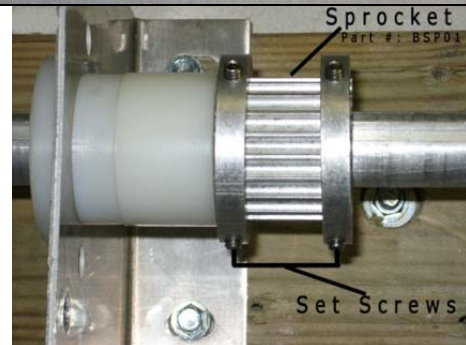

Insert key (Part No. K101) of sprocket kit into the keyway of sprocket and tighten the set screws.

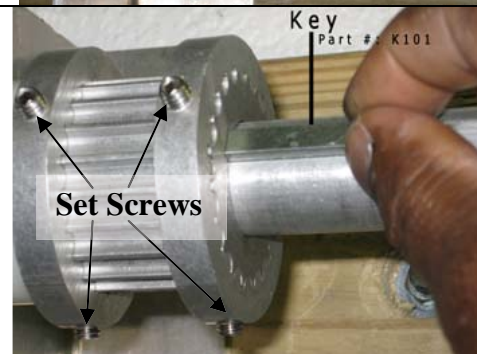
**Installing Tensioner Kit**

Before installing the air cylinder, the tensioner kit must be installed. (Part No. OT101).

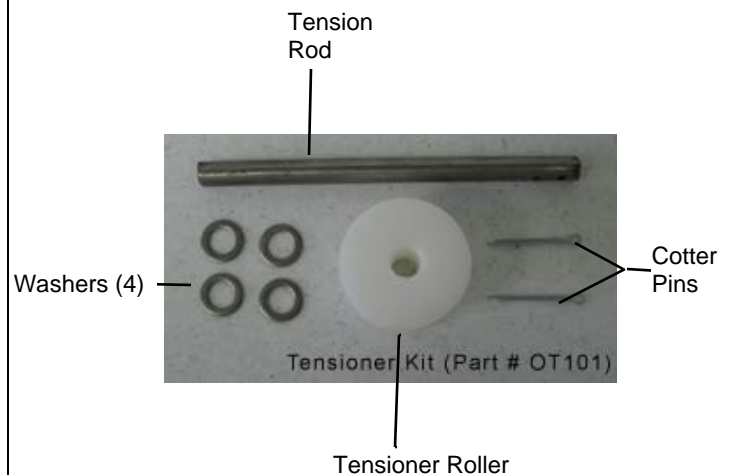

Installing Tensioner Kit

Insert one end of the tensioner rod with holes into round hole of the track bracket.

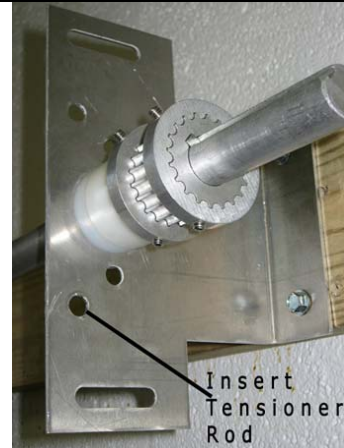

Place 1 washer on each side of bracket and add cotter pins (Part No. DF330).

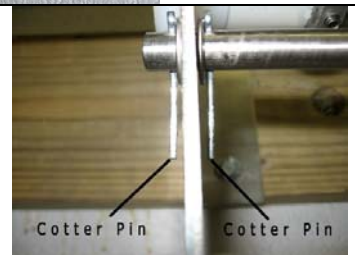
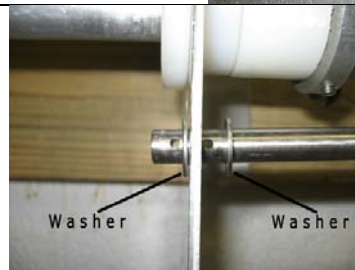

Place tensioner roller on rod (as shown). End support bracket will be installed after hanging the operator. Proceed to Step 3.



Step 3

Install speed control kit to the operator. (Part No. TC2002).

Speed Control Kit (Part No. TC2002)



Installing Speed Control Kit

Before installing the speed control kit to the operator, place the operator flat on floor with the red plugs facing up. Remove red plugs from the air powered operator. Insert brass elbows (Part No. AP1080B) into ports of both cylinders where red plugs were removed.

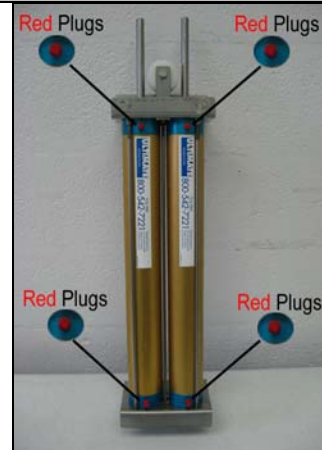

Tighten elbows slightly with 9/16 open-end wrench. Attach speed control valve at top of operator bracket with (2) two each 10x24x3/8 machine screws.

As shown on Page 5

After installing valves stretch air lines from top to bottom elbows, cutting air lines $\frac{3}{4}$ " longer than bottom elbow. Attach air lines as shown.

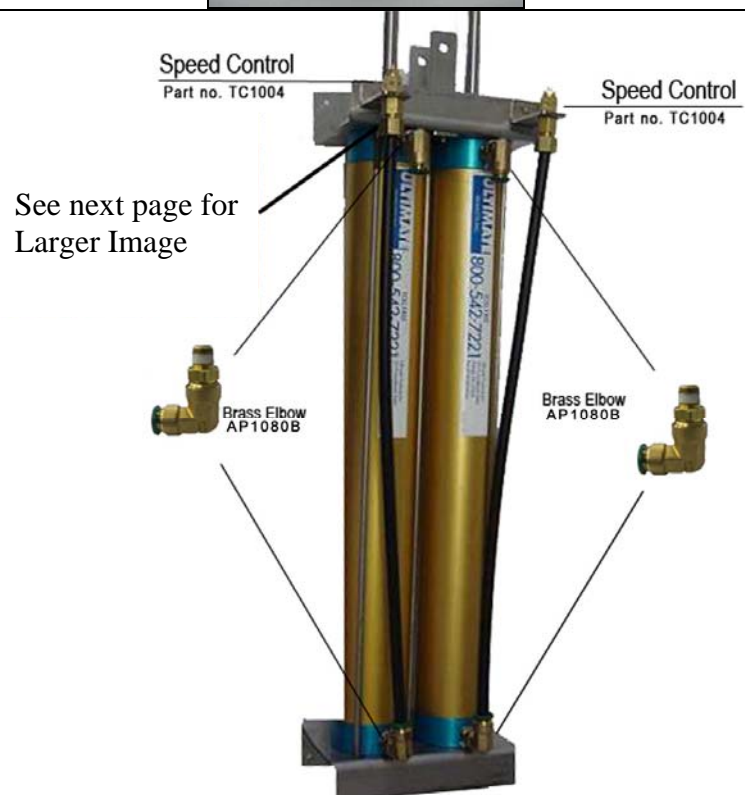

10 x 24 x 3/8 Machine Screws

Speed Control Valve with bracket



Step 4 Attaching Belt to Operator

NOTE: Remove clamp assembly CL-102 from belt before installing belt onto operator.

Operator Belt

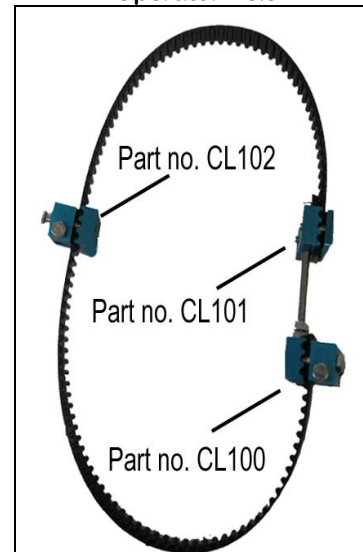

Remove belt roller (Part No. OP01) from center of operator. (roller is attached when operator is shipped from factory)

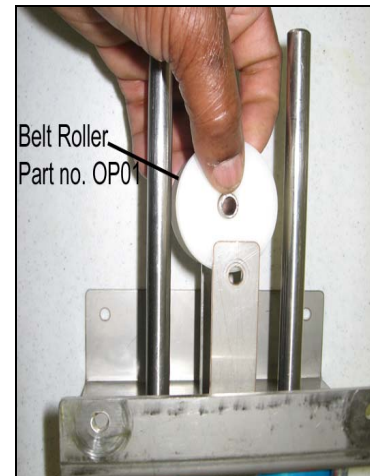

Slide bottom of turnbuckle onto rod closest to the wall leaving $\frac{1}{2}$ " of rod above turnbuckle (Part No. CL100). Tighten bolts of turnbuckle down onto rod and reinstall Belt Roller on operator.

NOTE: Turnbuckle will always be installed on rod that is closest to the wall

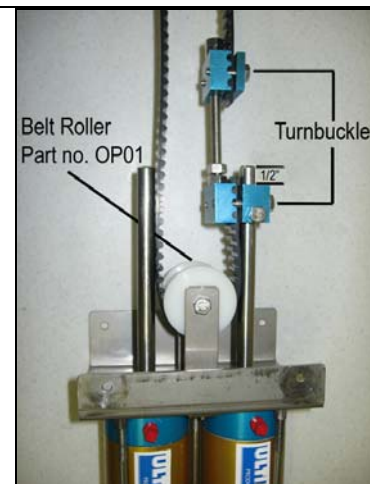

Hanging Operator

Step 5

Note: Insure door is fully closed before hanging operator.

Hang operator from the belt by placing the belt around the sprocket and behind Tensioner Roller, as shown.



Install end support bracket (Part No. **BB103A**) on door shaft. Making sure tensioner rod goes through hole of end support bracket. Attach end support bracket to wall before attaching operator to vertical track.

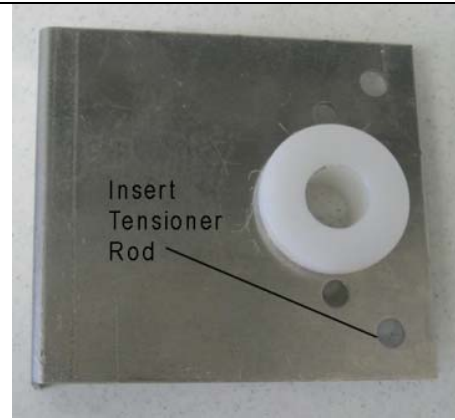

Completed Tensioner Kit will be as shown.

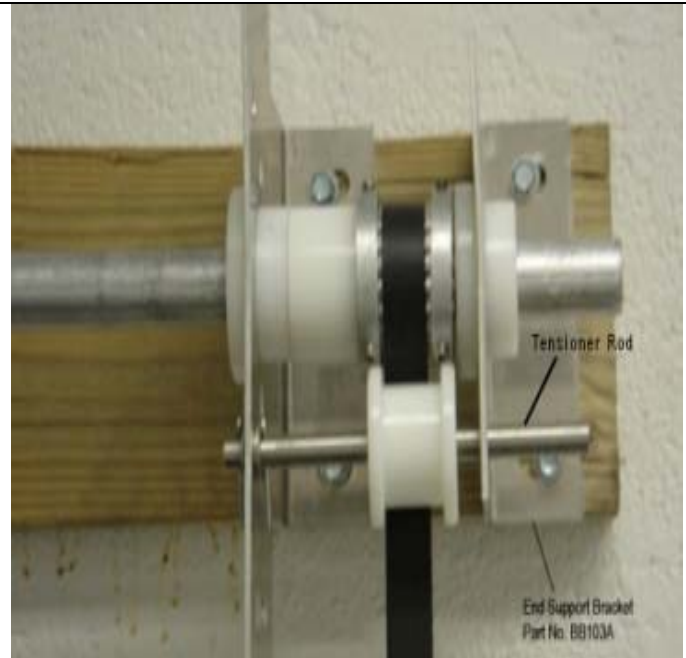

Attach top and bottom of the operator to the vertical track with self-tapping screws. (As seen in figures J and K on pg. 8)



Step 6 Setting Open and Close Door Limits

Begin by removing 1/2" nut from top of turnbuckle – (Item 'A')

Lower nut (Item 'C') down until desired tightness is achieved.

Using 1/2" open end wrench tighten nut (Item 'B') until belt is snug

After achieving desired tightness, install nut (Item 'A') back onto assembly

And tighten both item 'A' and Item 'C'

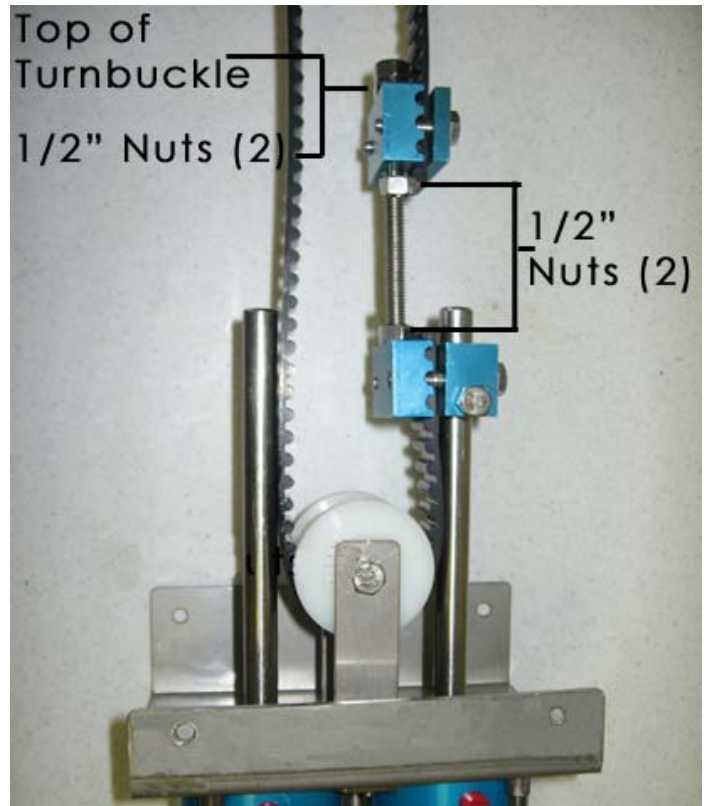
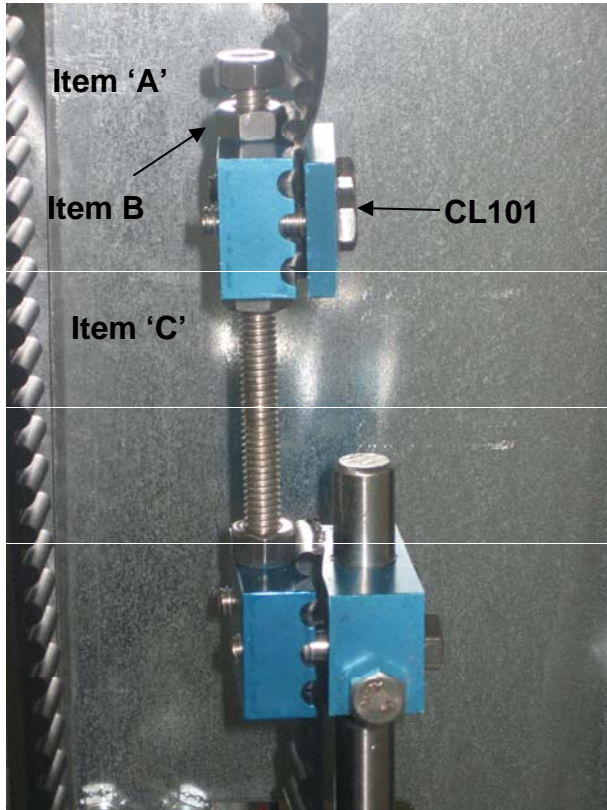
**Step 7**

Raise door manually to height of desired operation -- For example, if you want door to open 8 feet, raise bottom of door to be 8' off finished floor.



Rod with turnbuckle (Part No. CL100 and CL101) will rise when opening the door
Thus after opening door to desired height, the rod closest to the wall will be extended out of the cylinder

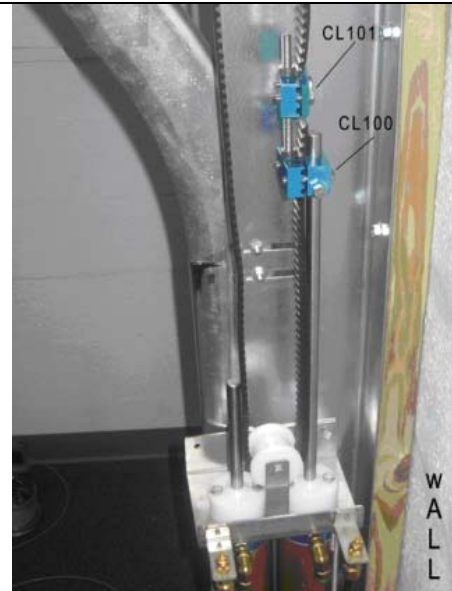

Now we will attach Part No. 'CL102' to the rod that is not extended out of the cylinder

Your open and close door limits are set. You are now ready for control box installation.
(See Part 3)

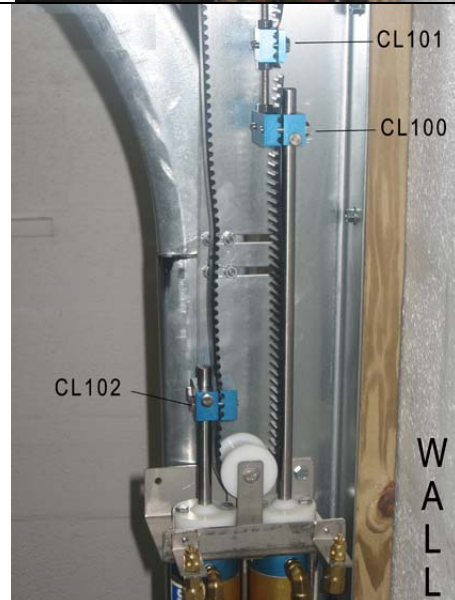

Completed Operator set up view.



Installation Of Chain Drive

Part 2:INSTALLING CHAIN DRIVE

STEP 1

NOTE: Before beginning installation make sure you have chain roller set-up (Part No. AP1325).

Determine which side of the door you are installing the air operator on; you will need at least 6" of shaft beyond track bracket for installing air-powered operator with chain.

See Figure A.

Figure A

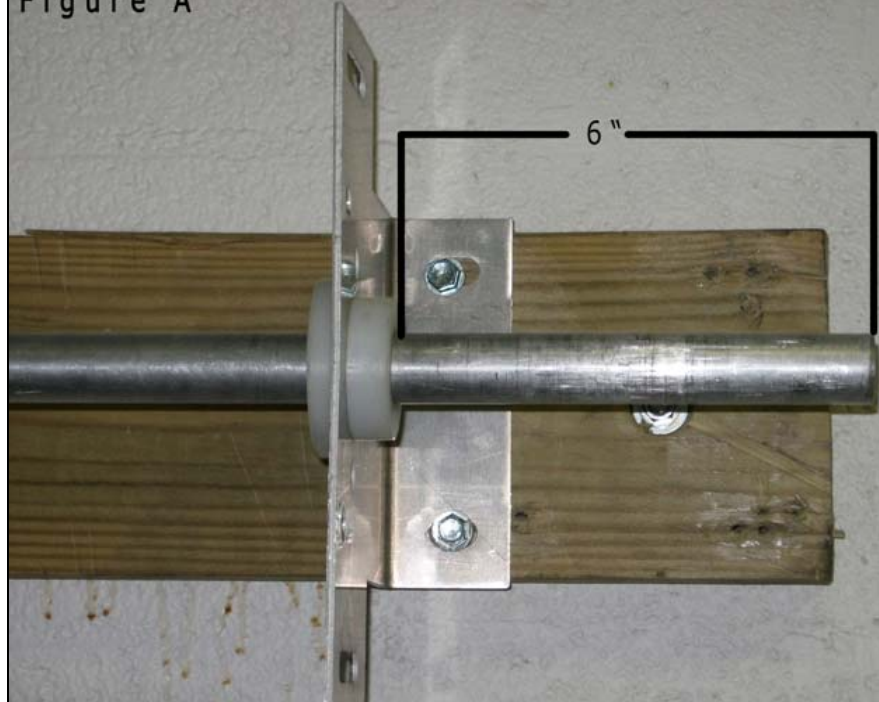

STEP 2

Position the chain sprocket assembly (part # spk 1000) onto shaft against bearing as shown in figure B. Do not tighten set screws until you have hung operator around sprocket.

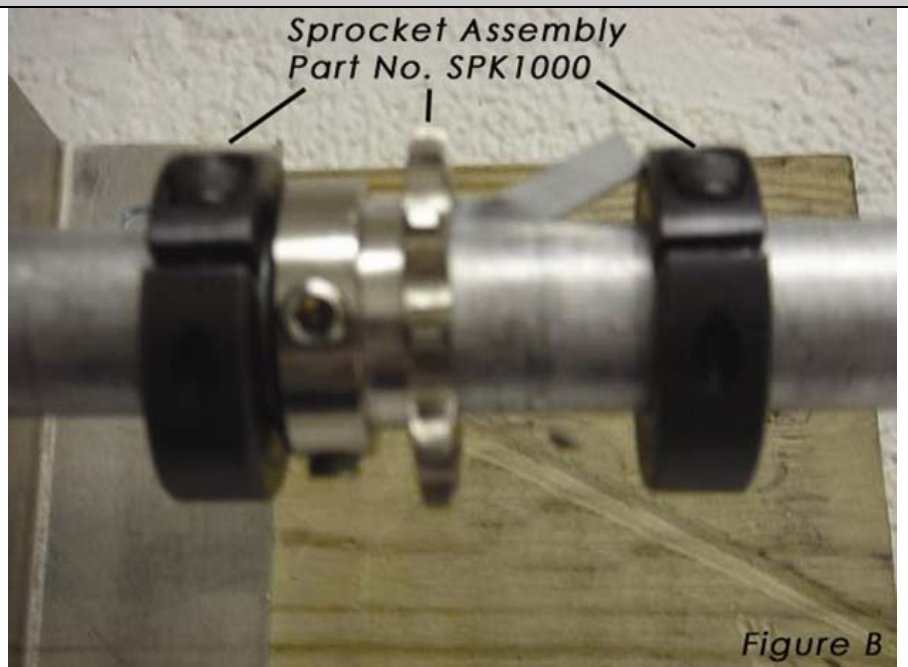

Figure B

**Step 3
Installing Chain**

Lay air powered operator on floor with red plugs facing up. Remove chain roller (Part No. AP1325) from top of operator **See Figures C & D.** If you are installing operator on right hand side of door, install turnbuckle of chain on the rod that is closest to the wall. Insert chain around bottom of roller (Part No. AP1325), attach roller back onto operator with threaded rod of turnbuckle, 1/2" above piston rod. **See Figure E.**

Note: Turnbuckle will ALWAYS be installed on the rod that is closest to the wall.

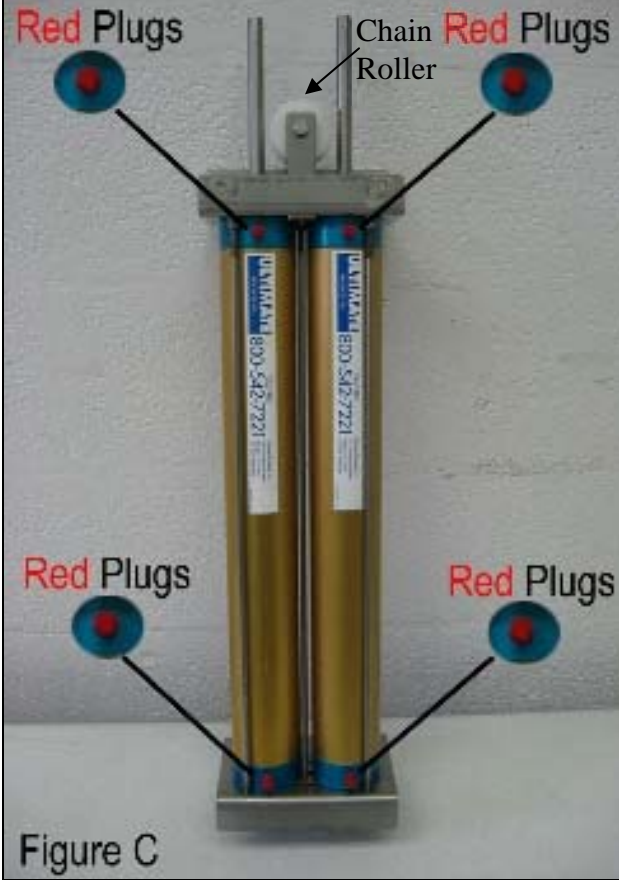

Figure C



Figure D

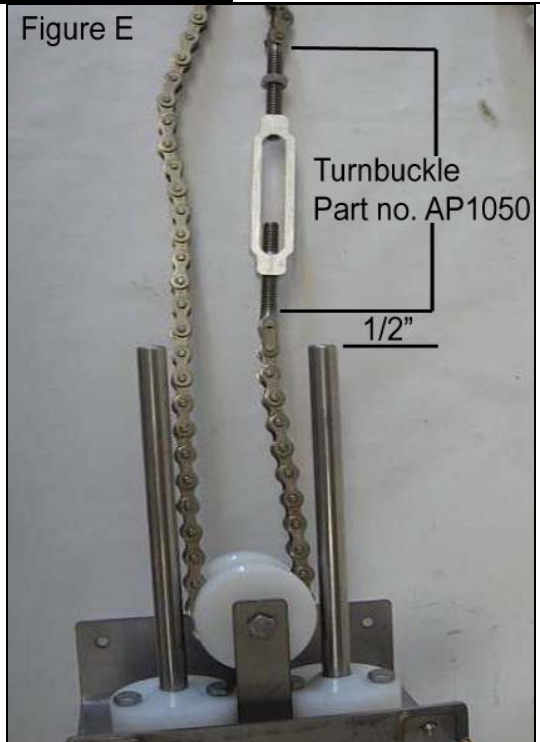
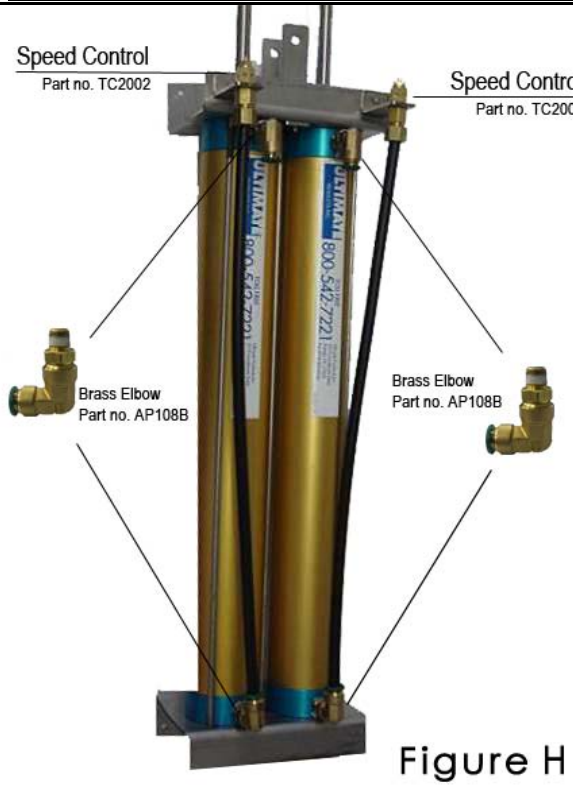
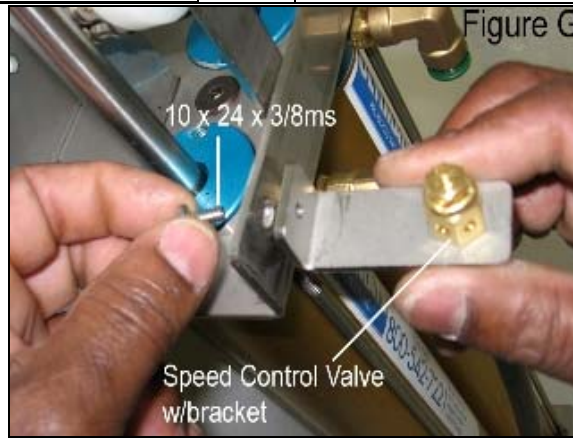
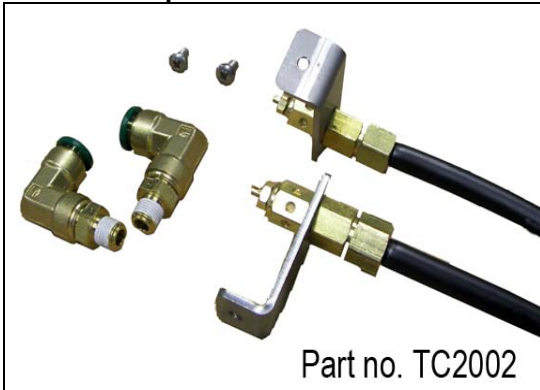

Figure E

Step 4

Before hanging air-powered operator, install speed control kit (Part No. TC2002). Locate kit with speed control valves, elbows, and two remaining elbows of sprocket kit. Remove red plugs from air powered operator insert brass elbows *See Figure F*. Tighten slightly with 9/16 open-end wrench. Attach speed control valve at top of operator bracket with (2) two each 10x24x3/8 machine screws (provided) as shown in *Figure G*. After installing valves stretch air lines to bottom elbows, cutting air lines 3/4" longer than top of elbow. Attach air lines as shown in *Figure H*.

Speed Control Kit



Step 5

Hang chain of air powered operator around chain sprocket. Align operator with vertical track and align sprocket with operator. Tighten all set screws on sprocket and collars of sprocket assembly, add support bracket (Part No. BB103A) before attaching operator to vertical track. See Figures I & J.

Sprocket Assembly (Part No. SPK1000)

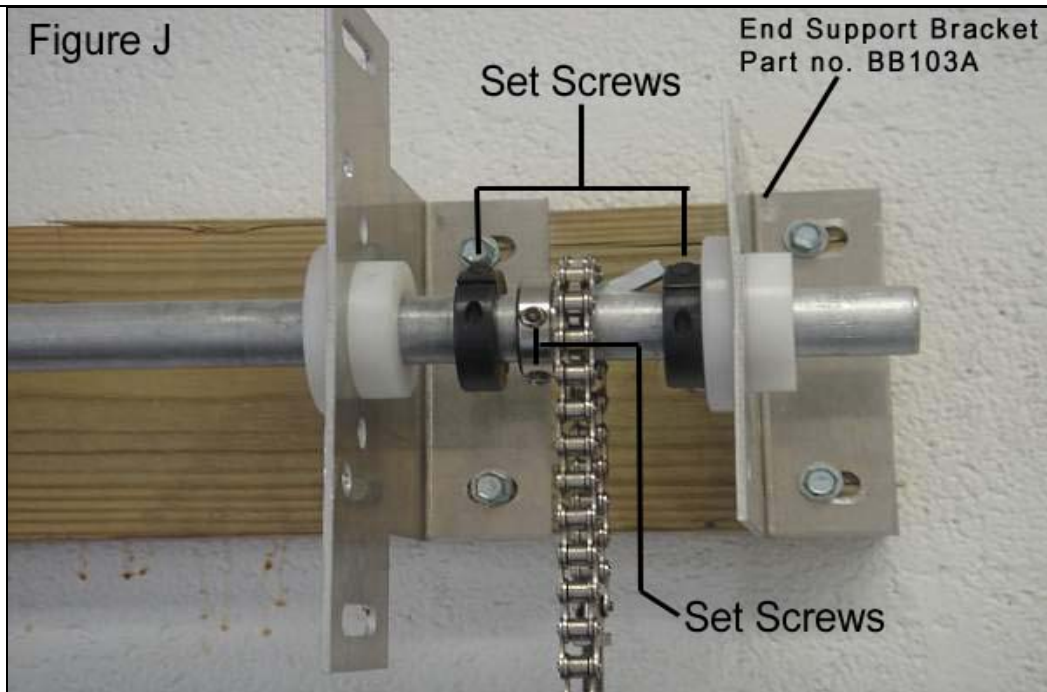
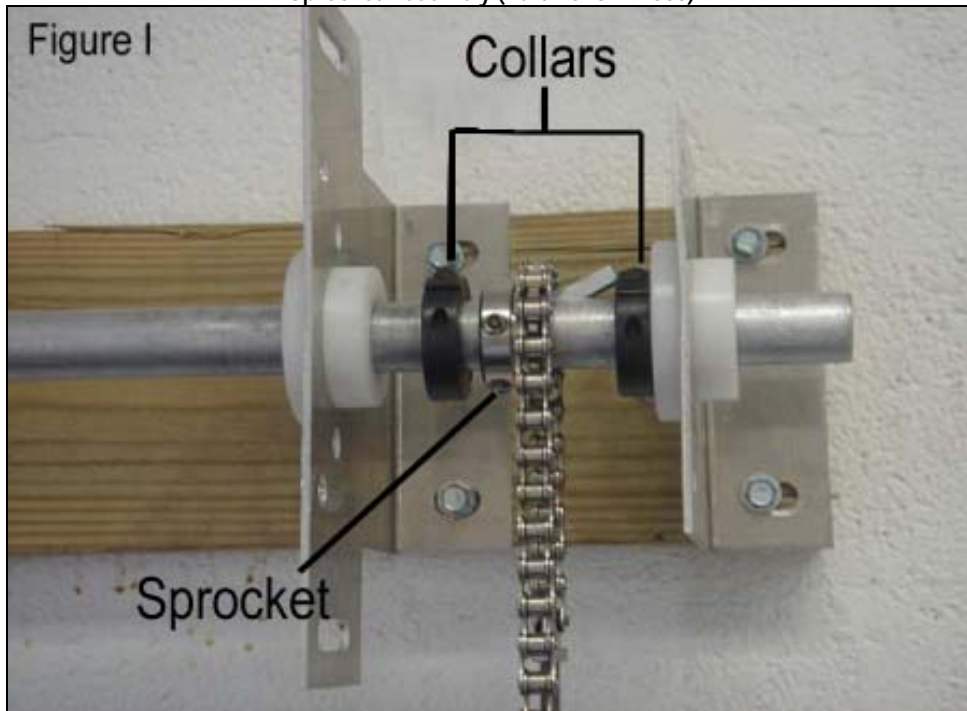

Step 6

Attach operator to vertical track after it is aligned with sprocket and operator hangs straight down using self-taping screws. *See Figure K.* Tighten chain with turnbuckle. After chain is tight, lock turnbuckle into place with $\frac{1}{2}$ " nut on threaded rod. *See Figure L.* Slide one enclosed clamp assembly **Part No. AP1055** so that $\frac{3}{4}$ " of the rod extends above the clamp assembly as shown in *Figure M.* Tighten all bolts.



Figure K

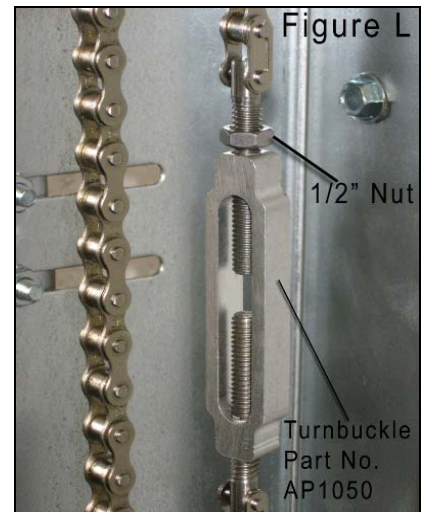

Figure L

1/2" Nut

Turnbuckle
Part No.
AP1050

Figure M

3/4"

Clamp Assembly
Part No. AP1055

Rod with turnbuckle (Part No. CL100 and CL101) will rise when opening the door
Thus after opening door to desired height, the rod closest to the wall will be extended out of the cylinder



Now attach Part No. 'CL102' to the rod that is not extended out of the cylinder
Your open and close door limits are set. You are now ready for control box installation.



Completed Chain Operator set up, see Page 35.

ULTIMATE PRODUCTS INC.
PHONE: (800)

Part 3:

Install the control

A.

There are several different control options available for your air-powered operator, depending on how you would like to control your door.

Choices are as follows:

DC1000: Manual, lever-operated, 3-position air valve.

DC4000: 24V Control Box that only works when the electricity is on. It Does NOT HAVE buttons.

DC5000: 24V Control Box that only works when electricity is on. Has buttons.

DC6000: 24V Pneumatic control box that will work without electricity by drawing upon the air built up in the compressor.

DC7000: 120V Pneumatic control box that will work without electricity by drawing upon the air built up in the compressor. Has large, red emergency buttons.

B.

Mounting and Electronic Control Box:

1.

Before installing control box (seen below), install all regulators, dryers etc.



2.

Install control box near operator and 110V power supply. If not possible, the control box can be installed in equipment rooms, attics etc. Installing a Quick Dump Exhaust may be needed depending on the distance between the control box and the operators. The control box should be mounted 4-5 ft off finished floor with proper anchors. (See below)

Note: Control Boxes require 110V AC power unless specified on the unit



Part 4:

Installing Air Lines

A.

1. Connect air line at control box.
2. Connect top port of control box to 90 degree elbow on cylinder closest to wall with airline. (see below)



3. Connect bottom port of control box to elbow on cylinder farthest away from wall. (See below)



B.

Install a single 3/8" air line from compressor (or closest air source) to the air line dryer on the control box.(see figure below)



Part 5:

Testing Operator and Control Box

Note: Every Step must be completed before connecting the signal-sending devices.

A. Plug the control box into 110V AC outlet.

B. Pull up black knob on top of Regulator. Turn knob clockwise to increase air pressure. (See below)

Note: Recommended pressure varies between 60-100 PSI



C. Press open or close on the control box to begin operating the door.

Note: If door operates opposite of what controls indicate, Turn air pressure off at regulator and reverse the two air lines at cylinders.

Part 6a: U Series

Door speed adjustments and fine tuning

Note: Only for U Series operators

A. Door slows down too soon when opening.

Step 1- Locate the speed control valves at the top of the operator. The speed control valve farthest from the wall controls up. (See below)

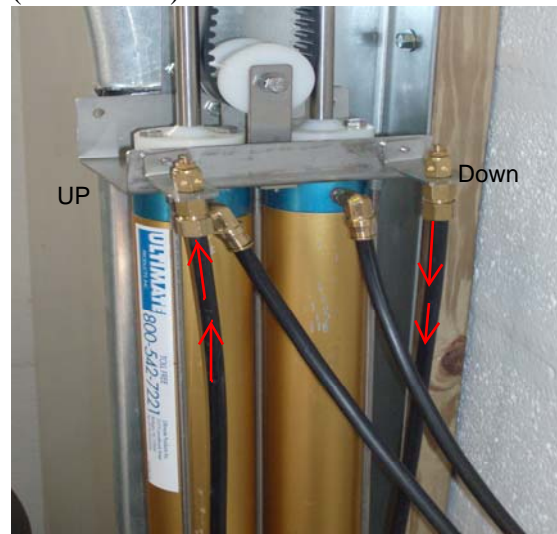

Step 2- With a small flat head screw driver, turn thread post on speed control valve ¼ turn counter clockwise. Open the door to see if door has desired cushioning. Repeat this step until satisfied with setting. Lock setting into place with nut around threaded post. (See below)

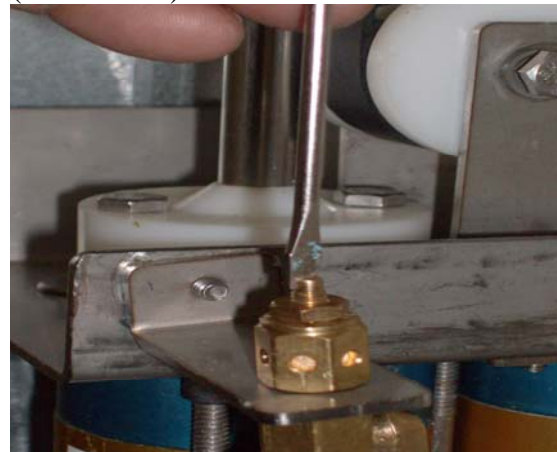

Part 6a: U Series

Door speed adjustments and fine tuning continued.

Note: Only for U series operators

B. Door slows too soon when closing

Step 1- Speed control valve closest to wall controls down. Follow same procedure as Part A, Step 2.

C. Door opens slowly and closes rapidly.

Step 1- If counter weights are available, add more weight if necessary. For doors with springs you may need to add more tension.

D. Door goes halfway and stops

Step 1- Check the door itself to make sure nothing is binding the door. Also check speed control valves to make sure they are adjusted properly.

Part 6b: S Series

Door speed adjustments and fine tuning

Note: Only for S series operators

A. Door Slows Down too Soon When Opening:

1. Locate the airflow control screw on the bottom of the up cylinder (farthest from the wall).
2. Turn the airflow control valve one complete turn counter clockwise or until the door operates properly.

Note: Use caution: Unscrewing too far will cause it to come out. When screwing it back in, pay attention to the two holes adjacent to each other on the bottom cap. Placing the screw in the wrong hole causes the loss of the cushioning effect. The correct hole has threads.

B. Door Opens too Quickly (Bangs or Slams Into Upper Limit):

1. Locate the airflow control screw on the bottom of the up cylinder (farthest from the wall).
2. Turn the airflow control screw one complete turn clockwise or until the door operates properly.

Part 6b: S Series

Door adjustments and fine tuning continued

Note: Only for S series operators

C. Door Slows too Soon When Closing:

1. Locate the airflow control screw on the bottom of the down cylinder (closest to the wall).
 2. Turn the airflow control screw one complete turn counter clockwise or until the door operates properly
- Note: Use caution: Unscrewing too far will cause it to come out. When screwing it back in, pay attention to the two holes adjacent to each other on the bottom cap. Placing the screw in the wrong hole causes the loss of the cushioning effect. The correct hole has threads.

D. Door Closes too Quickly (Slams Into Floor):

1. Locate the airflow control screw on the bottom of the down cylinder (closest to the wall).
2. Turn the airflow control screw one complete turn clockwise or until the door operates properly.

E. Door Goes Up Slowly and Comes Down Rapidly:

1. Check the door spring torsion. The springs may need tightening or may be broken. If you have counterweights, make sure that they are properly balanced and weighted.
2. If the springs are fine and the door is properly balanced, check the breather vent on the bottom of the air cylinders. The ball on top of the breather vent should be free to float with the air flow and the vent should be clean.

F. Door is Jerky or Needs a Boost to Get Started:

1. Check the door itself. Make certain the rollers, track and torsion springs are lubricated and not binding. If you have counterweights, make sure that they are balanced. Also check the bottom of the operator for air leaks. When the door is stationary, you should not hear air leaking.

G. Door Goes Partway and Stops:

1. Check for air leaking from the bottom of the cylinder. A stationary door should not have any air leaking from it.
2. If air is leaking, the piston needs new seals. Call UPI at 1(800)542-7221 for a seal kit.
3. If there is no air leaking, check the collars that hold the chain/belt to the piston rod, or the sprocket that connects the chain/belt to the door shaft. One or the other may be slipping.
4. Check the door for binding.
5. Check the tension shaft bearings to see if they are working.
6. Check the needle valves to make sure they are not too tight.

H. Door Goes Up and Down Slowly:

1. On the bottom cap of the cylinder, there is a breather vent screwed into the cap. This allows air into the cylinder when the piston is moving upwards. The breather vent has a small check ball floating above it. If the check ball sticks or the breather vent gets clogged, the operator will not function properly. It may operate slower than usual, stop partway, or slam when opening or closing. Use a 7/16" wrench to remove the breather vent. Make certain the ball is free-floating and the breather vent is not clogged. Clean it using a solvent and an air hose, or call UPI at 1(800)542-7221 to order a new breather vent.

Part 7:

Install Signal Senders

A.

At this point the door, the operator, and the control box should work. The installation of signal senders is complicated and where the most problems generally occur. Be sure to follow these directions carefully. Signal senders include: hose switches, pull cords, electric eyes, magnetic loop detectors, radio remotes, reversing edges or any combination of these.

B.

Use common bell or thermostat wire to connect the signal senders to the automatic control box. All of these devices use 24 volts AC. It may be necessary to have a licensed electrician install these controls. Check local building ordinances.

C.

Connect no more than one signaling device at a time. Make certain that each device works independently before connecting the next one.

Note: If you have trouble with installation, call Ultimate Products at 1(800)542-7221 between 9A.M. and 5P.M. EST for free advice. After 5, leave a voice-mail message and your call will be returned the next business day.

Part 8:

Troubleshooting

The troubleshooting section covers problems for a door that will not move. If your door is working, but not to your satisfaction, go to Part 6--Door Speed Adjustments and Fine-Tuning.

There are only 5 areas of trouble:

- The door and its hardware
- The operator and its connections
- The control box and the air valve
- The air compressor and the air line
- The signal senders

A.

Have someone operate the door and listen for air which exhausts through the valve mounted in the control box.

1. If you hear air, the problem is in the door or the operator. See 8B--Fixing Door or Operator Problems.
2. If you do not hear air, the problem is in the controls. Go to 8C--Fixing Control Problems.

B.

Fixing Door or Operator Problems

1. Check the operator and the chain or belt. If the operator piston moves up and down when operated and the door doesn't move, the problem is in the connection between the door shaft and the sprocket (slipping sprocket), or the chain/belt and the piston shaft (loose chain/belt, collar or broken chain/belt).
2. If the pistons don't move when the door is operated and it is expelling air, either the air pressure is not set high enough to raise the door, or the door is binding. Check the air-pressure gauge on the control box. It should be about 50-60PSI. Increase the air pressure about 5PSI at a time until the door moves. Do not exceed 90PSI. If the door still doesn't move, listen for air leaks near the operator. There should not be air leaking when the door is stationary. If it is leaking, go to Part 11--Rebuild Kits.
3. If the door is still not moving then the problem is with the door itself or the hardware. Visually check the door for a broken spring, uneven counterbalances, binding track, or bent rollers. If nothing is wrong, move to step 4.

4. Check the motion of the door. Turn the air pressure to zero and push the controls up and down a few times to expel any air left in the system. Manually raise the door. Go slowly and do not force the door up -- air is being expelled from the bottom cylinder. If the door moves normally, go to step 5.
5. Loosen the turnbuckle that holds the chain/belt loop together. Remove the chain/belt from the sprocket on the door shaft. Remember the position of the piston rods so readjustment will not be needed when the chain/belt is put back on. Manually move the door open and down. If it moves easily the problem is within the cylinders of the operator. If not, turn off the air cylinder--the door needs repair. Call UPI at 1(800)542-7221. If the door is moving easily, pull each piston out of the cylinders as far as possible and compare their lengths. They should be equal. Push the pistons as far into the cylinder as possible. Again, the lengths should be equal. The piston rods will not move easily as air is entering or exiting the valve at the bottom of the cylinder. If the piston lengths are not equal or if they will not move, then the problem is either in the cylinder or the pistons. Call UPI at 1(800)542-7221 to order a rebuild kit or to arrange to send the operator back for rebuilding.

Deluxe Control Box--Jump a wire between terminals 13 and 15: the door should open. Jump a wire between 14 and 15: the door should close. If the door does not move there is probably a conflicting signal from one of the other devices. Try disconnecting a single set of wires (from one signal device) at a time. Try the control box each time you disconnect a set of wires. When the door works, the disconnected device is the problem. If jumping the wires in the control box does not move the door when all of the devices have been disconnected call UPI at 1(800)542-7221 to order a new control box.

C.

Fixing Control Problems

Caution: Do not operate, adjust, or perform installation or maintenance on any part of the system without first disabling all electrical power to the system. Use extreme care to prevent electrical shock when working in a wet environment.

1. If there was no air-exhaust noise when an attempt was made to open the door make certain the filter/regulator gauge on the control box is between 60 and 90PSI. Do not use the gauge on the air compressor -- the air line may be blocked between the compressor and operator making the gauge inaccurate.
2. Determine if the problem is the signal-sending device or the control box. First check the control boxes:
Standard Control Box--Disconnect all wires from the terminals (some setups have a switch to do this within the system). Jump a wire between the common and open terminals: the door should open. Jump a wire between common and close: the door should close. If this happens, then the problem is in the signal-sending device. If nothing happens, call UPI at 1(800)542-7221.

Part 9:

Automatic Oiler Adjustment

ONLY USE WITH MODEL "S" OPERATORS

A.

Using a 10-weight, non-detergent oil, fill the oiler through the top cap (similar to a lawn mower oil cap) or remove the bottom bowl. Do not use antifreeze or heavy weight oil.

B.

Adjustments to the oil flow are made by turning the cap on top of the oiler. A turn to the (+) direction increases the oil flow; a turn to the (-) direction decreases oil flow. One drop of oil should appear in the glass bulb on top of the oiler every time the door cycles.

C.

Keep the oiler filled at all times.

Note: Leave the oiler about 1/4 of the way open.

Part 10:

Cable Jumping

A.

Door cable is jumping:

A shaft-type operator depends upon gravity to bring the door down. If the shaft starts unwinding, and the door does not move the cable will form a loop on the drum and come off it. This will happen during sudden direction reversals, when the door freezes open, or if the door hits something before fully closed.

B.

Putting the cable back on the drum:

1. Turn the air pressure off.
2. Disconnect the chain or belt from the operator.
3. Secure the door in a fixed position with a vise-grip under a roller. It is easiest to do this when the door is a few inches above the floor.
4. Use a pipe wrench to twist the door shaft against the spring or counterweight just enough to get the cable back on the drum.

Caution: Never loosen the spring or remove the cable from the drum. There are several hundred pounds of tension on this cable, and severe bodily injury can occur.

5. If the cable will not go back on the drum, call UPI at 1(800)542-7221.

C.

Cable jumping solutions:

1. Raise the track: Raise the rear of the horizontal track several inches. This will give the door a slight downward incline and help it get started down.
2. Don't open the door all the way: Do not open the door to its maximum height. This will conserve heat and acts as if the door has a high-lift track. The top limit is easily adjusted by changing the connection point where the operator is attached to the chain or belt.

3. Lower the air pressure: Lower the air pressure to the operator. The door will not operate as quickly and the shock of the immediate reversal of the door won't loosen the cables.
4. Restrict the air flow: Install a valve in the air line to restrict the airflow. This will slow the reaction time of the door and still maintain the desired air pressure.
5. Balance the door: Balance the door by checking spring tension or counterweight. If the springs are wound too tightly, or the counterweight is too heavy, the door may not come down properly and cable could get slack.
6. Cable keepers: This is a spring that attaches to the bottom roller shaft and hooks to the cable. It requires 1 1/4 inches of space between the door and the track.
7. Pusher springs: Pusher springs give a door stuck in the horizontal position a shove to get it started. These are available from most door companies, or call UPI at 1(800)542-7221.

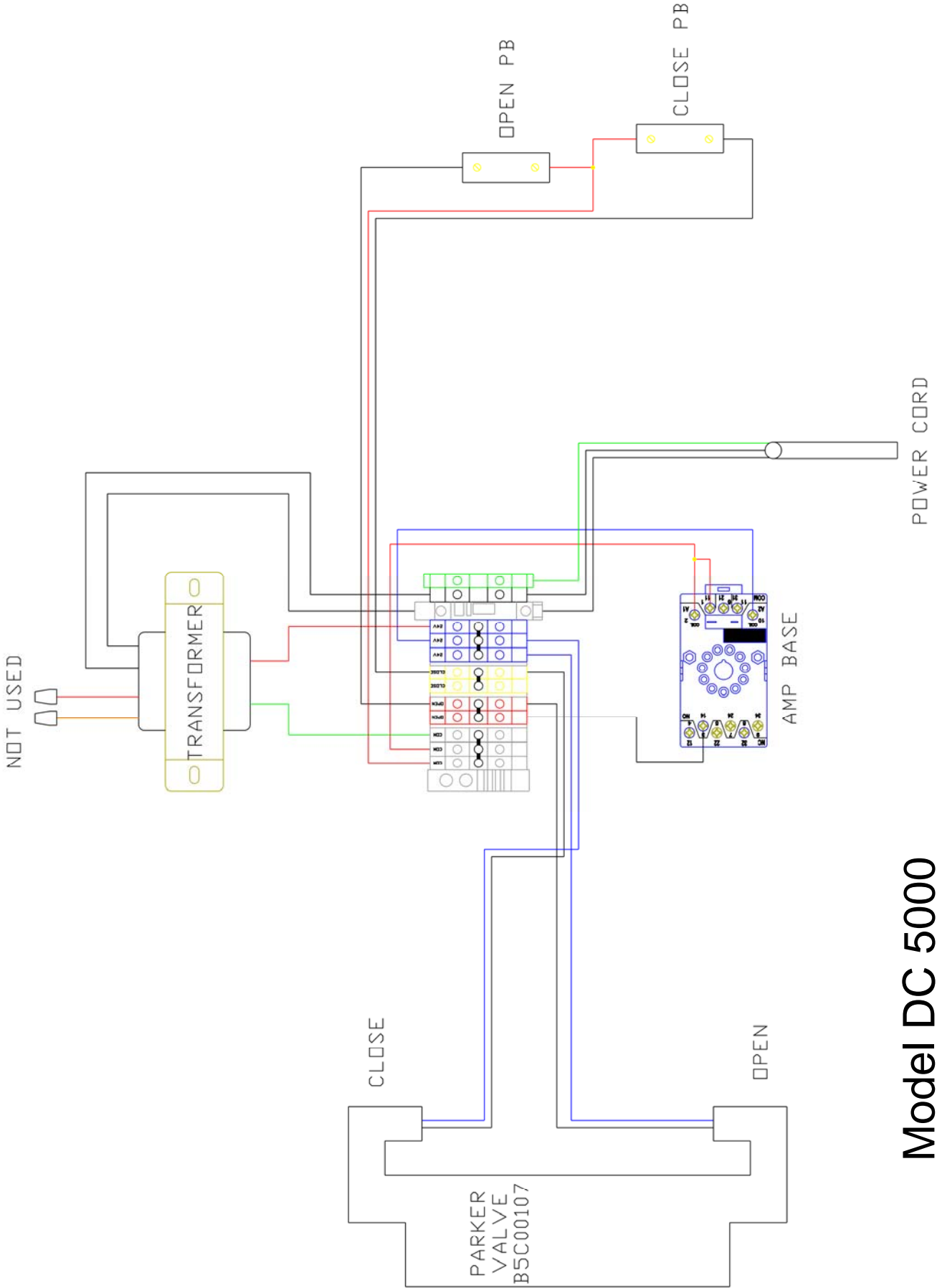

Model DC 5000

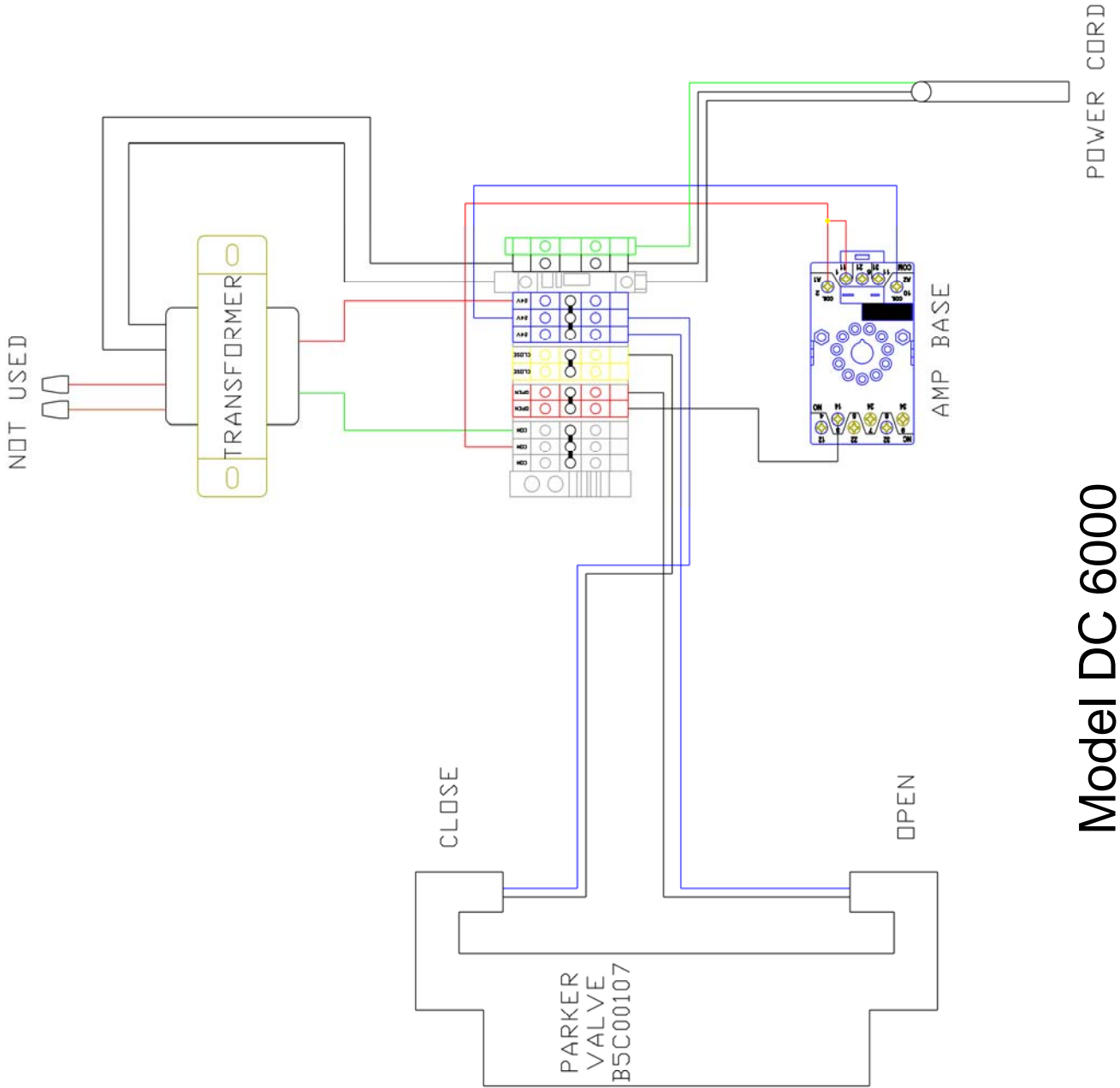

Model DC 6000

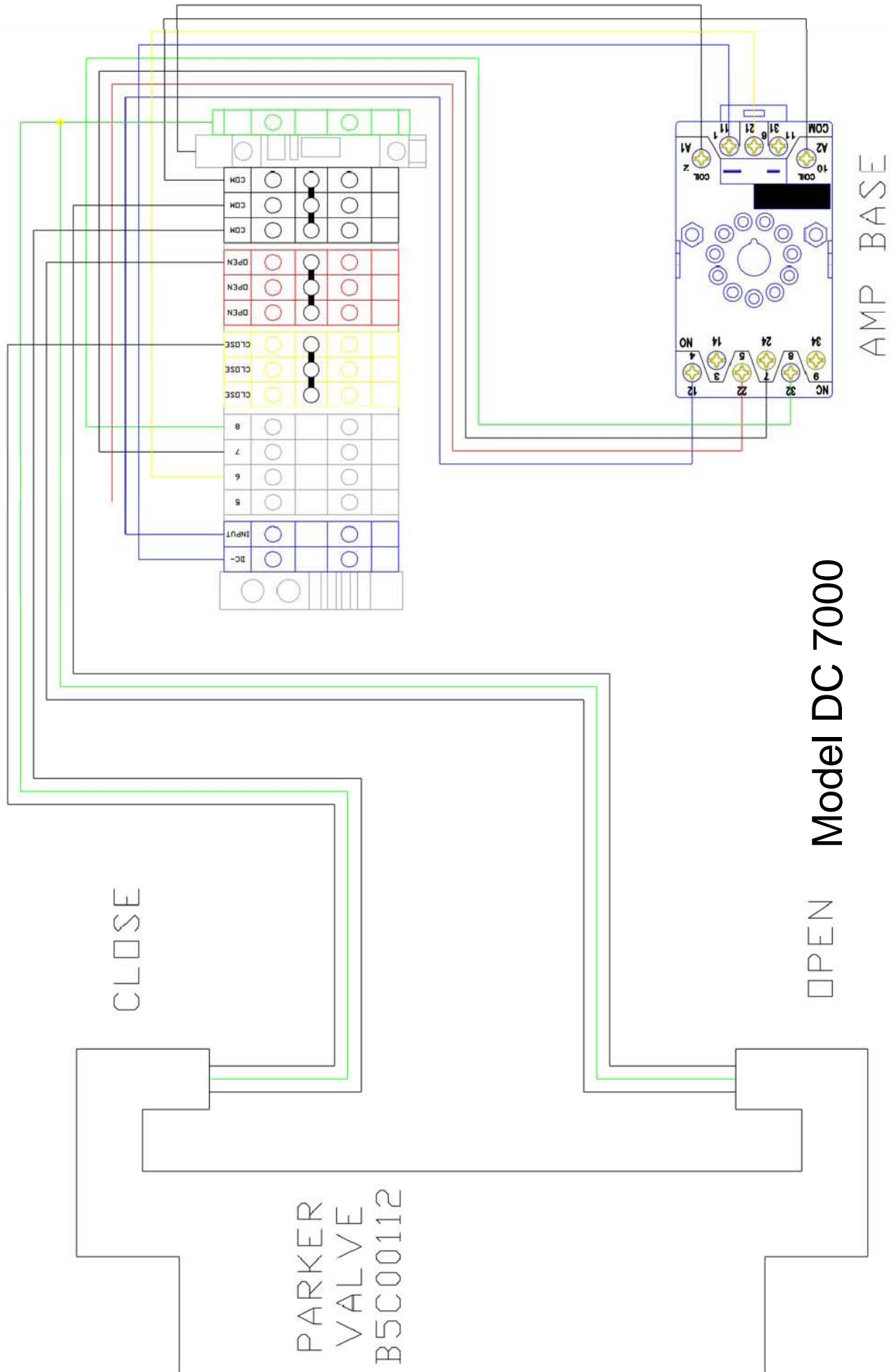



Typical Control Box Set-Up

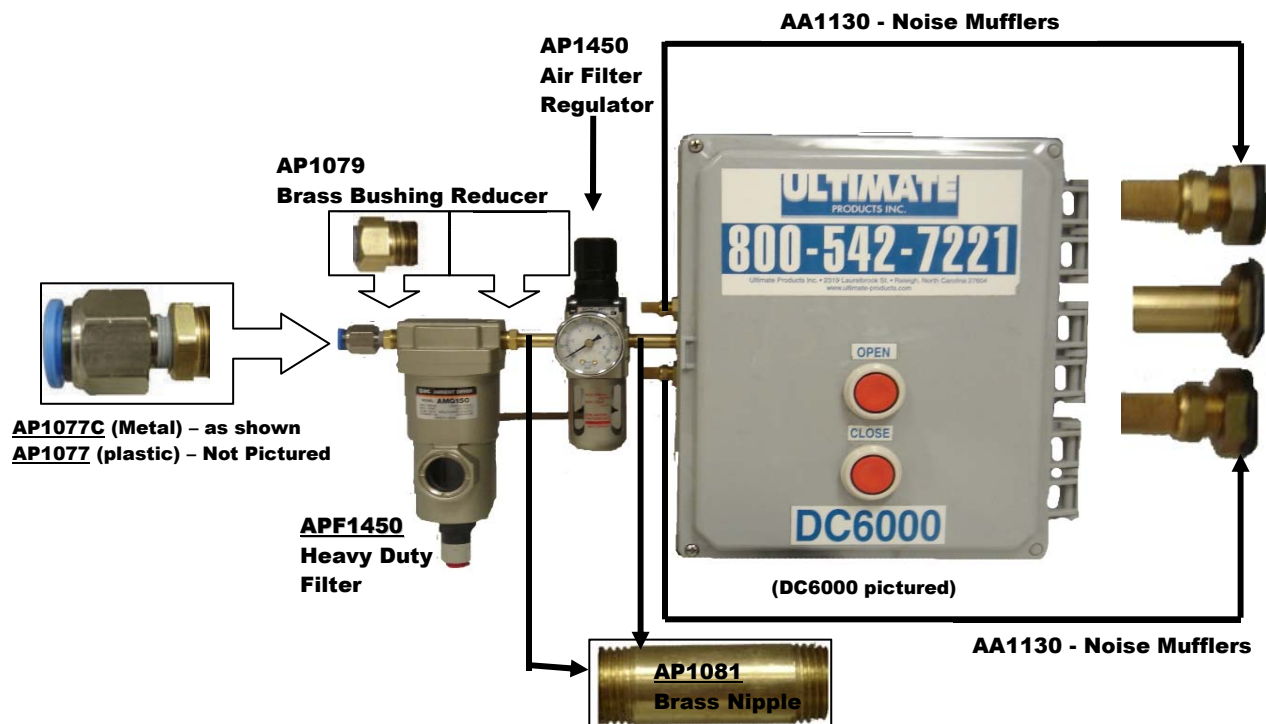

Part #	Description
AA1130	Noise Muffler
AP1077C	3/8"x 1/8" Male adapter quick connect (Metal)- used on air filter regulator - PC 3/8 N01
AP1077	3/8"x 1/8" Male adapter quick connect (Plastic)
AP1079	1/4" x 1/8" Brass bushing reducer
AP1081	1/8" x 1 1/2" Long brass nipple
AP1450	Filter / regulator complete
APF1450	Heavy Duty Filter

Home of the Best Buy Guarantee!

Ultimate Products, Inc.

Raleigh, NC

Toll Free: 800.542.7221 Fax: 919.834.4526

www.ultimate-products.com

Photo Amplifier Wiring Directions

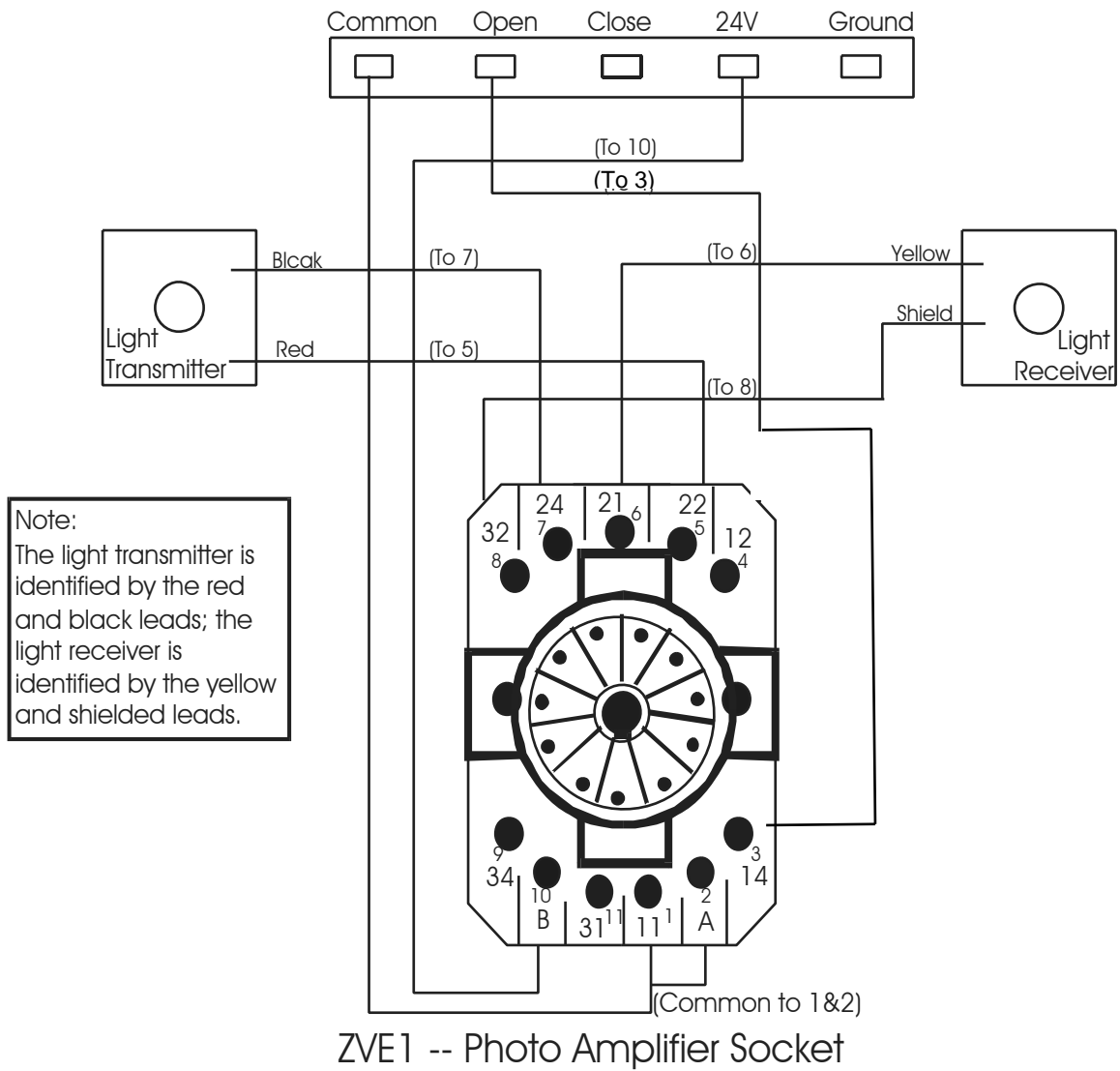

Connections for Relay Output

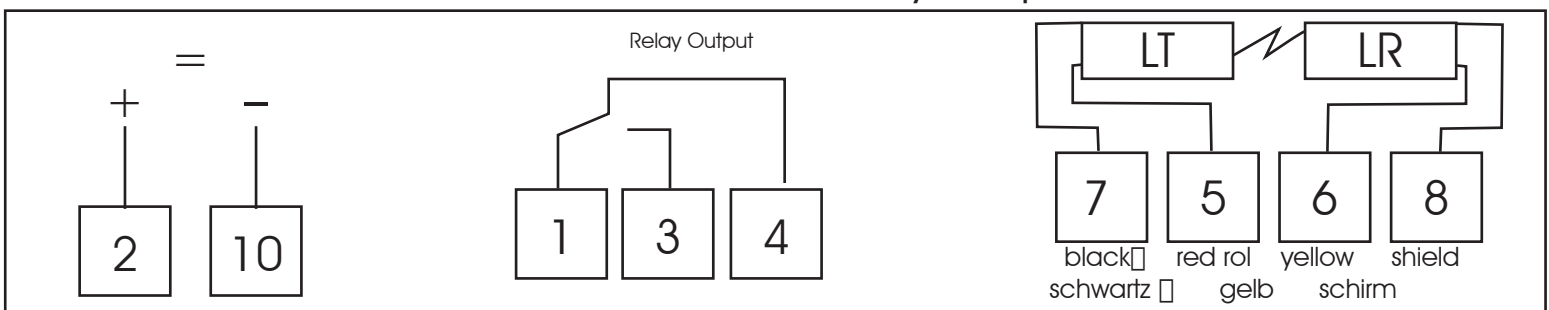

Limit Switch Wiring and Mounting

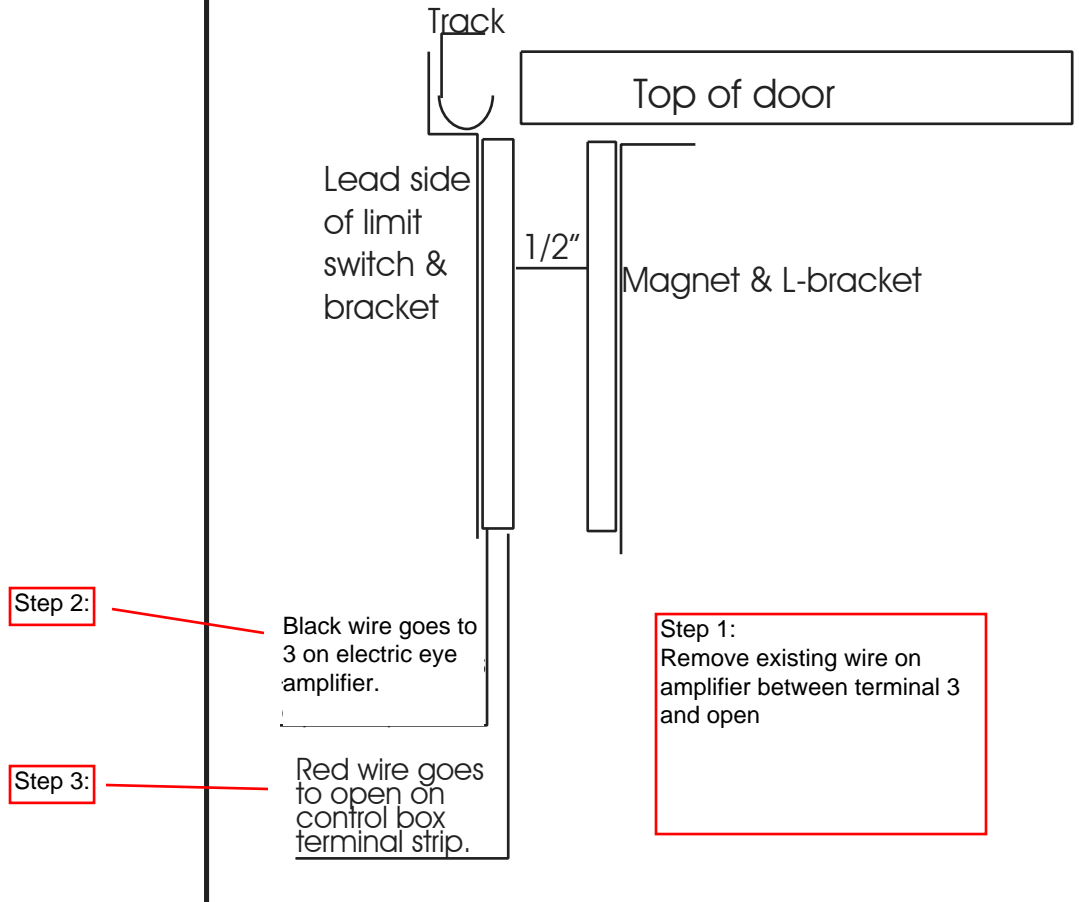

Wiring Diagram for Magnetic Loop

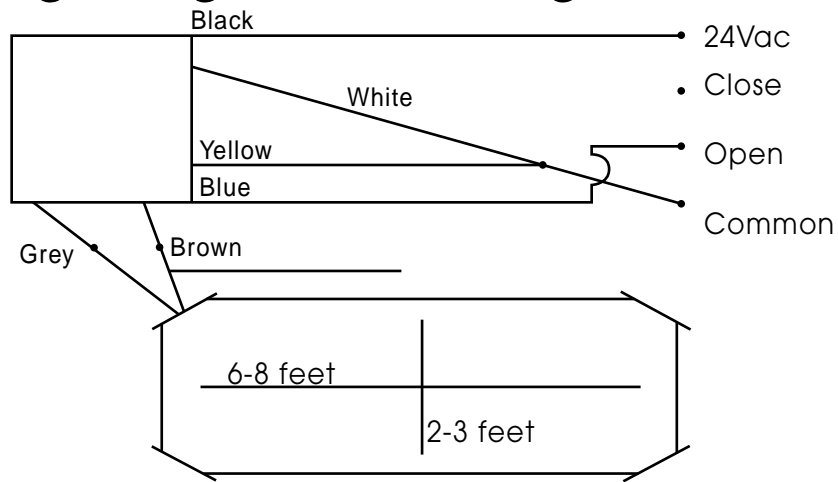

Cut one groove and put wires on top of each other starting at the detector. Follow the groove to the rectangle and go around it three times, one on top of the other then back to the detector. You end up with two wires at the detector which go to grey and brown.

Suggested Installation of Magnetic Loop

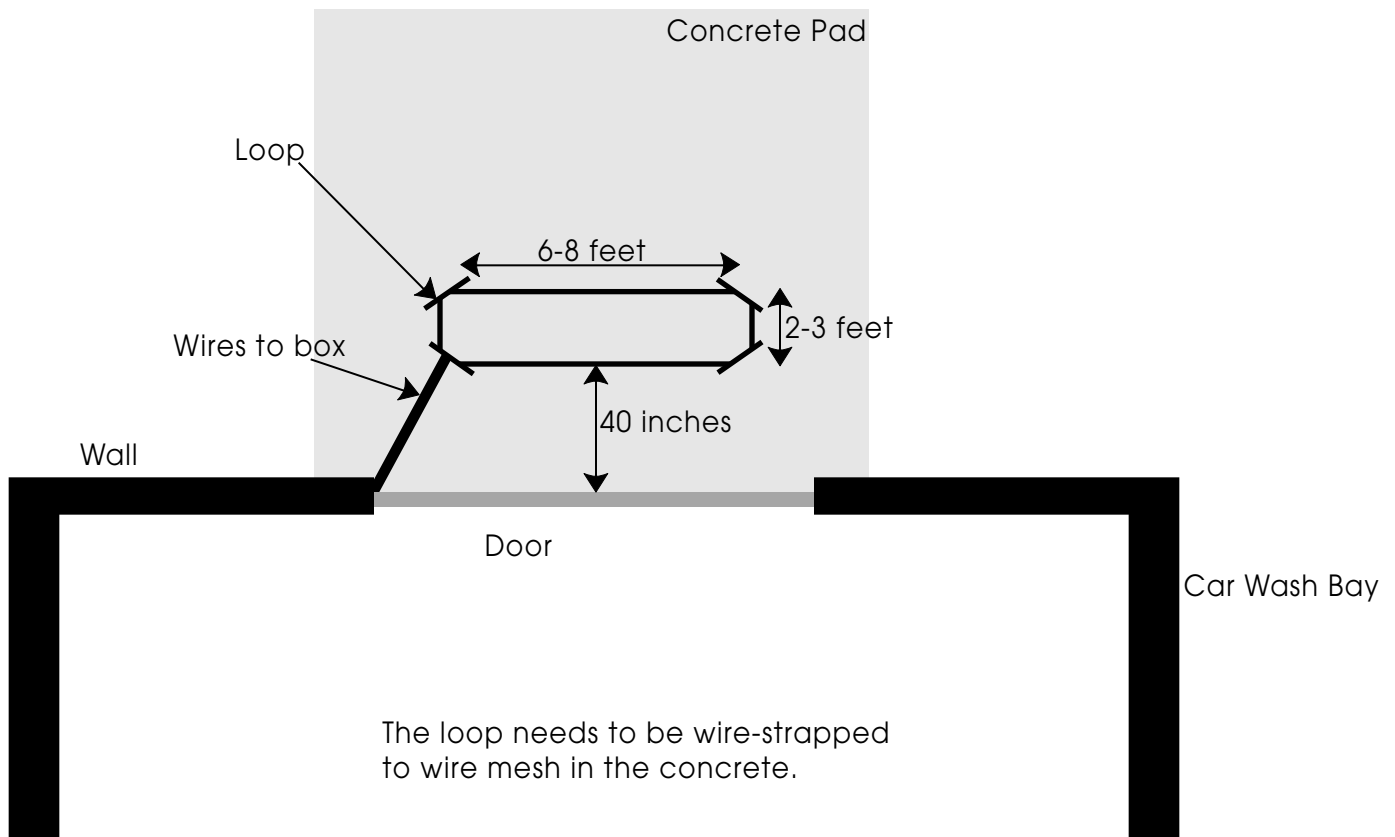

Wiring Diagram: Finder Timer to Control Box

!!DISCONNECT POWER BEFORE PROCEEDING!!

1. Timer is supplied pre-wired to the accompanying relay and is mounted on Din Rail.
2. Unplug Photo Amplifier from Amplifier Base.
3. Unclip Amplifier Base from existing Din Rail.
4. Remove existing Din Rail by removing the two screws that attach it to the back panel.
5. Install new Din Rail with Timer attached to the back panel. (Screws are self-drilling and self-tapping)
6. Reattach Amplifier Base to Din Rail.
7. Connect the 4 labeled wires to the appropriate terminals
 - (Black) Timer terminal #18 to CLOSE terminal on terminal block
 - (Blue) Timer terminal #A1 to 24V terminal on terminal block
 - (Red) Timer terminal #A2 to COMMON terminal on terminal block
 - (Black) Relay terminal #A2 to Amplifier Base terminal #4

Timer #1 – Set timer #1 for enough time for car to exit and clear. For example: Scale .05-1.0 minutes and turn dial to maximum setting (10).

Timer #2 – Set timer #2 on lowest scale (0.05-1.0 seconds) and turn dial to maximum setting (10).

Red Dip Switch set in up position.

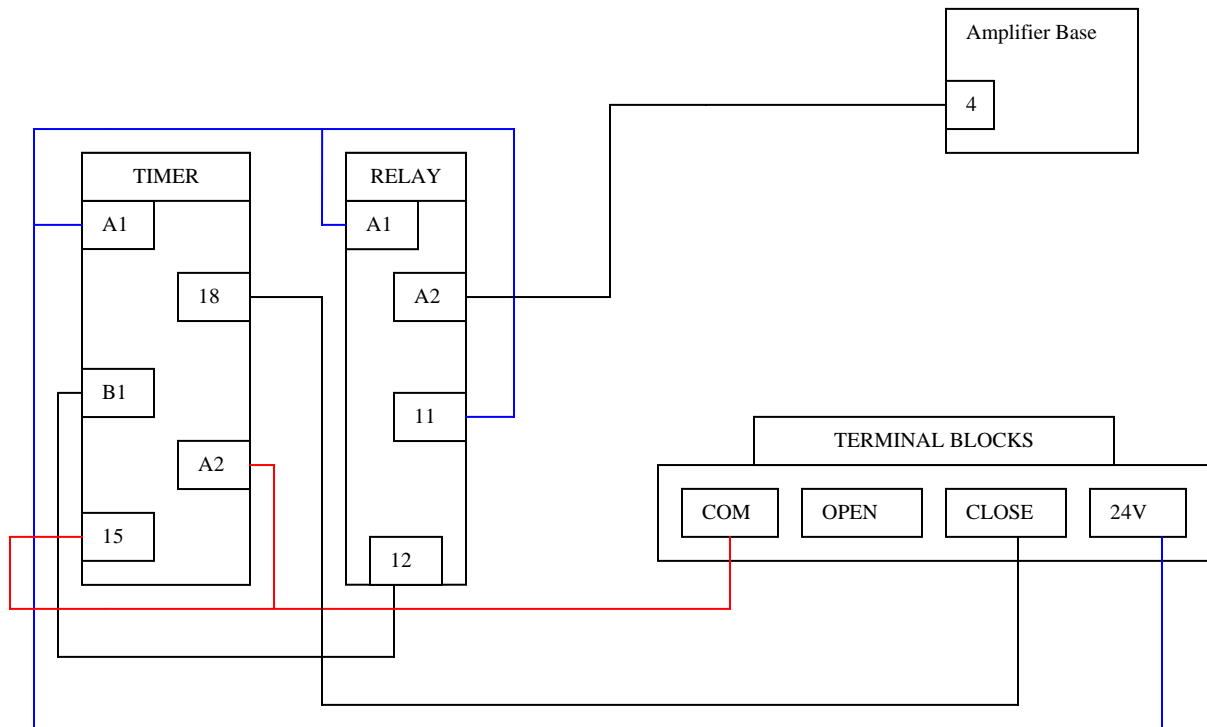

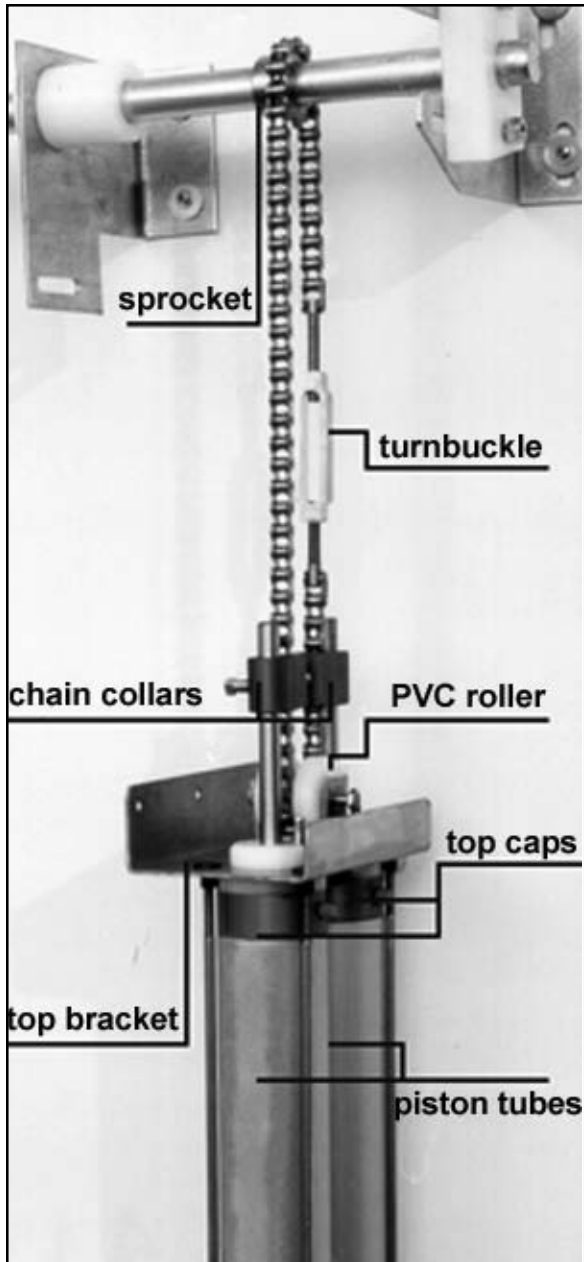

Operator with Chain

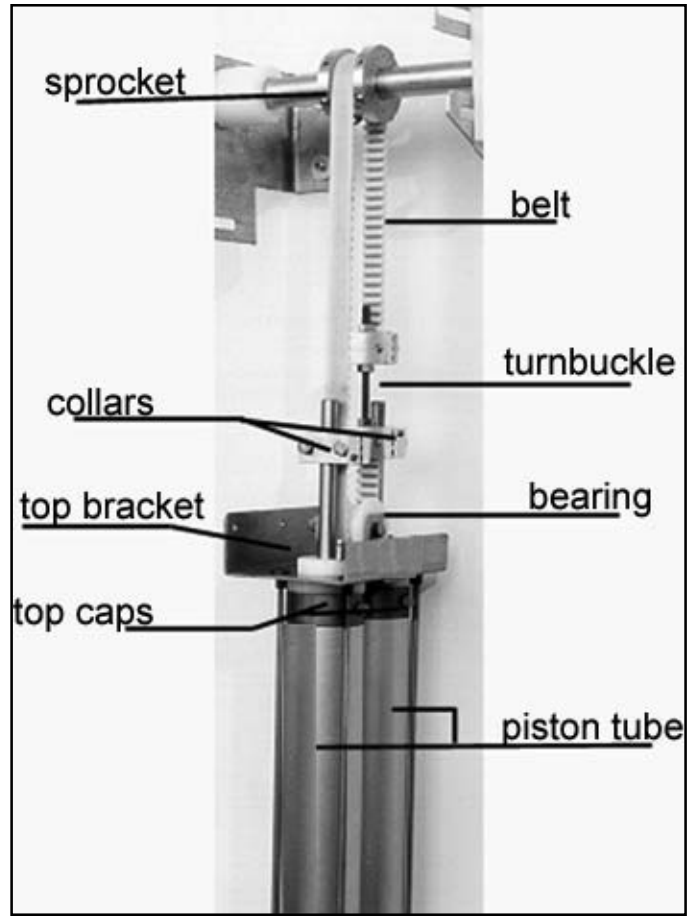

Operator with Belt

1. **retaining rod** — 8' (AP1354), 10' (AP1355), 12' (AP1356), or 14' (AP1357)
2. **tube** — anodized steel — 8' (AP1720), 10' (AP1721), 12' (AP1722), or 14' (AP1723)
— non-anodized steel — 8' (AP1701), 10' (AP1702), 12' (AP1703), 14' (AP1704)
3. **“o” ring** — AP1004
4. **check ball**
— nickel — AP1064
— stainless steel — AP1065
5. **bottom cap**
— Delrin — AP1058
— PVC — AP1059
6. **lock washer** — AP1352
7. **1/4” nut** — AP1353
8. **breather vent** — AP1060
9. **metering screw** — AP1070
10. **bottom mounting bracket**
— galvanized — AP1380
— stainless steel — AP1384
11. **brass nut** — AP1350
12. **3/8” X 1/4” reducing elbow** — AP1075
13. **piston rod seal** — AP1002
14. **bracket bolt**
— galvanized — AP1330
— stainless steel — AP1389
15. **chain guide bolt**
— galvanized — AP1328
— stainless steel — AP1388
16. **collar set screw** — AP1057
17. **aluminum collar** — AP1055
18. **collar sleeve** — AP1326
19. **1/4” lock nut** — AP1329
20. **chain roller** — AP1325
21. **chain guide bracket**
— galvanized — AP1327
— stainless steel — AP1387

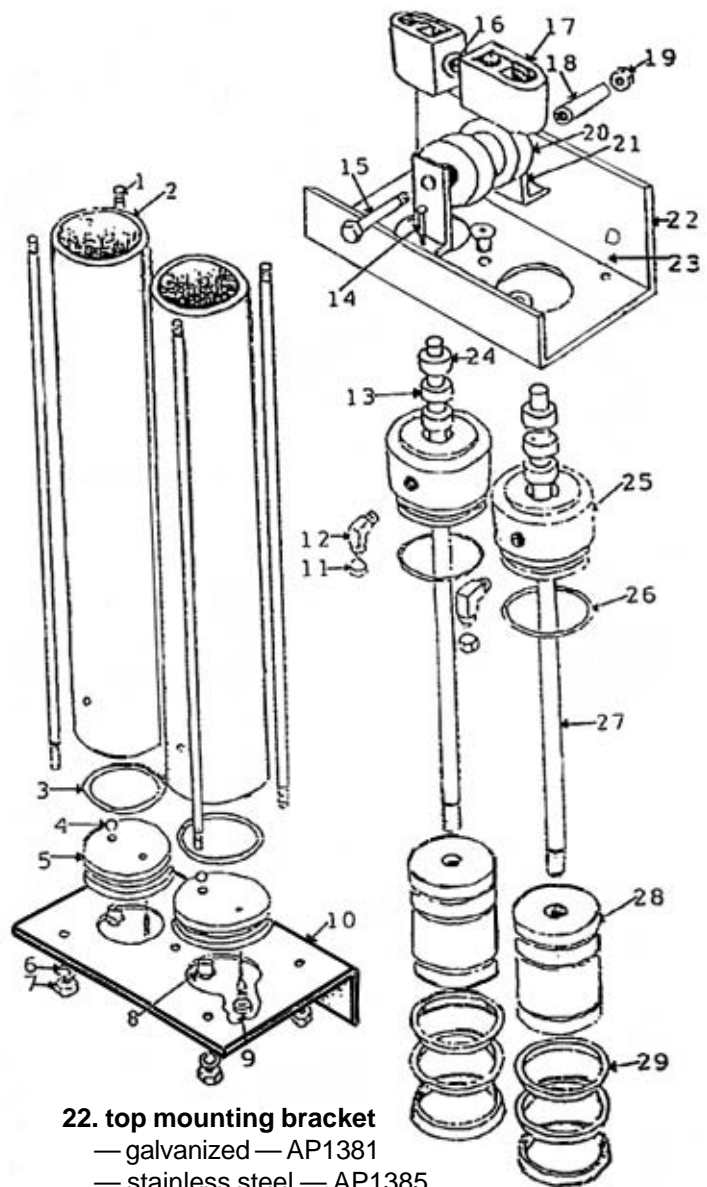

22. **top mounting bracket**
— galvanized — AP1381
— stainless steel — AP1385
23. **retaining rod nut** — AP1350
24. **piston rod seal retainer** — AP1003
25. **top cap**
— PVC — AP1001
— aluminum — AP1006
26. **“o” ring** — AP1004
27. **piston rod** — 8' (AP1302), 10' (AP1303), 12' (AP1304), 14' (AP1306)
28. **piston body**
— PVC — AP1214
— stainless steel — AP1200
29. **“u” cup**
— 6 cups — AP1211
— 1 cup — AP1210

Architectural Guide for Air-Power Operator System

Control Box

— Power Supply :

110V Plug in type. Solenoid valve available in 24V or 110V. Always 24V unless specified otherwise.

— Model:

DC1000: Lever-operated, three-position air valve.

DC4000: Control box that only works when the electricity is on (no buttons).

DC5000: Control box that only works when the electricity is on.

DC6000: Control box that will work without electricity by drawing upon the air built-up in the compressor.

DC7000: Line voltage emergency open red button. Used with Autec equipment

Note: Control boxes interface with all car wash equipment and operate by pulse.

— Mounting:

Control Box may be mounted in the wash or equipment room. Specify a quick-dump exhaust AA1210 (additional cost) if the control box is more than 40 feet away from the air compressor.

— Dimensions:

DC1000: 8 1/4 inches tall, 6 inches deep, 3 1/4 inches wide

DC4000: 11 1/2 inches tall, 6 inches deep, 10 1/2 inches wide

DC5000: 11 1/2 inches tall, 6 inches deep, 10 1/2 inches wide

DC6000: 12 inches tall, 6 3/4 inches deep, 10 3/4 inches wide

DC7000: 11 1/2 inches tall, 7 inches deep, 9 1/2 inches wide



Operators

— Air Usage:

Uses 0.4 cubic feet of air to open and 0.4 cubic feet of air to close.

— Air Pressure:

Regularly set for 40-90 PSI.

— Air Line:

3/8 inch PolyFlow line

— Operator Placement:

The operator is normally mounted to the side of the track (either side).
For extremely cold climates, the operator may be mounted on the horizontal track.

— Drive Mechanism:

The rod coming out of operator is attached to chain or belt by collars and the chain/belt goes around a sprocket on the shaft.

A Model — A mild-steel chain. Use with non-corrosive environments.

S Model — Nickel-plated chain

UA Model — Belt: Steel-embedded polymer belt, similar to a motorcycle timing belt.

— Operator Lifting Ability:

An 8 foot operator indicates that the operator will raise the door 8 feet high: a 10 foot operator lifts 10 feet high, a 12 foot operator raises the door 12 feet high, and a 14 foot operator lifts the door 14 feet high.

— Dimensions:

8 foot operator — 58 1/4 inches tall, 4 3/4 inches deep, 6 1/2 inches wide

10 foot operator — 68 1/4 inches tall, 4 3/4 inches deep, 6 1/2 inches wide

12 foot operator — 78 1/4 inches tall, 4 3/4 inches deep, 6 1/2 inches wide

14 foot operator — 88 1/4 inches tall, 4 3/4 inches deep, 6 1/2 inches wide



Maintenance Guide For Air-Powered Operators and Illuminator Doors

Superior or Economy Air-Powered Operators

Operators with chains

1. At least **once every three** months, lubricate the chain with a thick, gel-type grease. Do not use spray lubricants.
2. Make sure that the chain is not loose. Tighten the chain using a turnbuckle if needed. Do not over-tighten.
3. Grease the top cap of the operator with a good-quality lithium grease.
4. Periodically check for leaking seals. Use soapy water to see if bubbles form where the rod enters the cylinder. If the seals are leaking, purchase a rebuild kit (AP1015) or a complete top cap (AP1005).
5. Check the needle valve in the bottom cap for residue build up.
6. **Once a year:** Replace the bottom cap breather vent (AP1060) and check ball (AP1065).
7. Drain the air compressor **every day**, or install a spitter or drain valve.

Ultimate Air-Powered Operator

Operators with belts

1. Tighten the belt **once a year**. Tighten by adjusting the turnbuckle. Do not over-tighten.
2. Make sure that the belt is aligned on the sprocket properly. This prevents wear.
3. At least **once a year**, apply lithium grease to the fitting on the top cap to lubricate the inside seals. More frequent greasing will extend the life of the seals.
4. Periodically check for leaking seals. Use soapy water to see if bubbles form where the rod enters the cylinder. If the seals are leaking, purchase a rebuild kit (AP1015) or a complete top cap (AP1005).
5. Check the needle valve in the bottom cap for residue build up.
6. **Once a year:** Replace bottom cap breather vent (AP1060) and check ball (AP1065).
7. Drain the air compressor **every day**, or install a spitter or drain valve.

Cylinder Oiling

Operators with Automatic Oilers:

1. Set automatic oiler for one drop of oil for each complete cycle.
2. Keep oil bowl full at all times.
3. If water mixes with the oil, pour the oil out. Drain the air compressor and refill the bowl.

Operators without Oiler:

1. Reduce air pressure to zero.
2. Fully extend piston rod out of the cylinder by opening or closing the door.
3. Remove air line from the cylinder.
4. Fill a section (approx. six inches) of the air line with a lightweight (10 wt), non-detergent oil. Call (800)542-7221 to order this oil (AA1220). Phillips Petroleum — Magnus A-32 and Mobil Oil DTE-13M are equivalents.
5. Reconnect air line, cycle the operator and repeat the procedure on the opposite cylinder.
6. Return pressure to proper setting.
7. This should be done at least **every two months** for maximum performance and longevity. Oiling more frequently will extend the life of the operator.



Seal Kit Procedures for Air-Powered Operators

Items included in the kit:

6 U-cups
4 Piston Rod Seals
4 O-Rings
2 Breather Vents
2 Check Balls
2 Metering Screws
2 Seal Retainers

Tools and materials needed:

Rags
Lightweight Oil
Screwdriver
7/16" and 9/16" Wrenches
Vise-grip
Lightweight Hammer

U-cup Seals

1. Close the door and turn off the air to the operator. Note: The front piston is extended and the rear piston is down. When remounting the operator, make sure the pistons are back in the same position.
2. Disconnect the air lines from the operator.
3. Remove the operator from the track: Unscrew the two bolts holding the brackets to the track and take the chain or belt off the sprocket on the door shaft at the top of the opening. Leave the chain or belt on the operator.
4. Lay the chain or belt and the operator down together and disconnect the chain or belt from the piston shafts by loosening the set screws in the collars, and sliding the collars off the piston shafts.
5. Unscrew the bolts on the bottom of the 5 retaining rods that run the length of the operator. You will have to keep the rods from turning by using a vise-grip or pliers.
6. Remove the piston from the cylinders by pushing down on the piston rods forcing the bottom cap out of the cylinder. Clean the inside of the cylinders by pushing a lightly oiled rag through it with the piston rod.
7. Remove the old U-cup seals from the piston and clean the piston thoroughly. Note the location of the seals.
8. Put the new U-cup seals on the piston.
9. Put everything back together. When tightening the retaining rods, make sure they are tightened equally. Put the operator back on the track remembering to extend the front piston rod and to have the rear piston rod 1/2" from bottoming out.
10. Before reconnecting the air line, inject 8 to 10 inches of 10wt, non-detergent oil into the air line. Reattach the air lines and cycle the door.

Piston Rod Seals

1. Follow steps 1-5 above.
2. Remove the top cap from the operator by tapping it off and then sliding it off the piston rod.
3. Put the top cap in a vise with the seal retainer facing down. Insert a screwdriver in the middle hole and tap it with a hammer until the seal retainer and two seals come out.
4. Replace the old seals with the new ones and put the seal retainer back in. You may need a 1/4" punch to get them in. Insert one at a time and tap each one until it bottoms out. The spring side goes down.
5. Follow step 9 and 10 from above.

Breather Vents and Check Ball

The operator does not have to be removed from the wall for this procedure. On the bottom of each tube is a breather vent built into a 7/16" nut. Unscrew the breather vent with a 7/16" wrench and make certain the check ball comes out of the bottom cap. Clean with solvent and/or blow clean with air pressure. Replace in bottom of the tube making certain the check ball goes in the hole first.

Needle Valve

The needle valve adjusts the speed of the door during the last two feet of each cycle. The control screw closest to the wall controls the down cycle. The control screw furthest from the wall controls the up cycle. If you remove this needle valve, it is very important that you replace it in the same hole you took it from. This can be a problem because the exhaust hole and the threaded hole are the same size and actually touch each other. If you put the airflow control screw in the exhaust hole, you will lose control of the piston speed.



800-542-7221 • 2319 Laurelbrook Street, Raleigh, NC 27604

Contact us if you have questions about installation or maintenance. Technical assistance and salespeople are available Monday through Friday between 9am and 5pm, Eastern Standard Time. Ultimate Products is closed for national holidays.



800-542-7221 • 2319 Laurelbrook Street, Raleigh, NC 27604

Contact us if you have questions about installation or maintenance.
Technical assistance and salespeople are available Monday
through Friday between 9 AM and 5 PM, Eastern Standard Time.
Ultimate Products is closed for national holidays.

Free Manuals Download Website

<http://myh66.com>

<http://usermanuals.us>

<http://www.somanuals.com>

<http://www.4manuals.cc>

<http://www.manual-lib.com>

<http://www.404manual.com>

<http://www.luxmanual.com>

<http://aubethermostatmanual.com>

Golf course search by state

<http://golfingnear.com>

Email search by domain

<http://emailbydomain.com>

Auto manuals search

<http://auto.somanuals.com>

TV manuals search

<http://tv.somanuals.com>