

FP 107

Digital
Answer Machine

Caller ID

Speaker Phone



OWNER'S MANUAL

Uniden

CONTROLS & FUNCTIONS

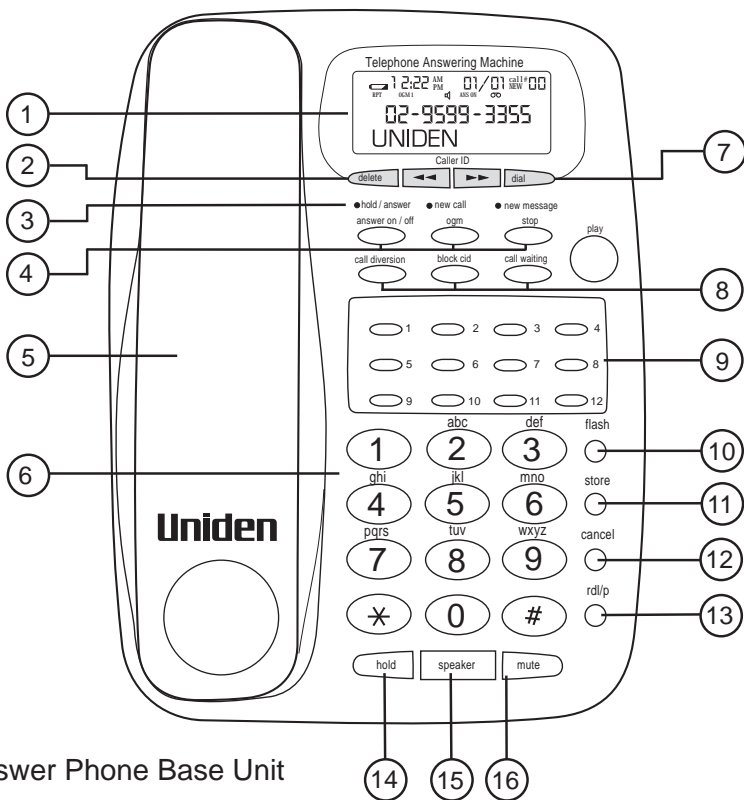

Answer Phone Base Unit

- | | |
|--------------------------------------------------------|-----------------------------------------------|
| 1 LCD Screen | 8 Call Diversion
Block CID
Call Waiting |
| 2 Delete | 9 12 one touch Speed Dial |
| 3 Hold / Answer LED
New Call LED
New Message LED | 10 Flash |
| 4 Answer on/off
Out Going Message (OGM)
Stop | 11 Store |
| 5 Handset | 12 Cancel |
| 6 Alpha Numeric Keypad | 13 Redial/Pause |
| 7 Dial | 14 Hold |
| | 15 Speaker |
| | 16 Mute |

LCD Screen

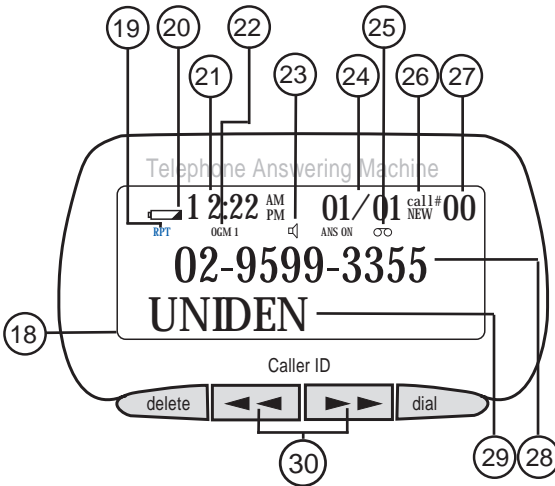

- 18 LCD Screen
- 19 Repeat
- 20 Battery low icon
- 21 Time
- 22 OGM 1
- 23 Speaker phone
- 24 Date
- 25 Message
- 26 New call icon
- 27 Call counter
- 28 Telephone number
- 29 Name
- 30 Review

Base Unit - right side

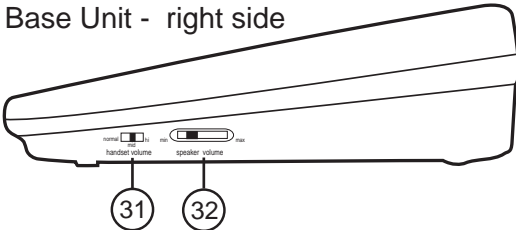

- 31 Handset volume control
- 32 Speaker volume control

Base Unit - left side

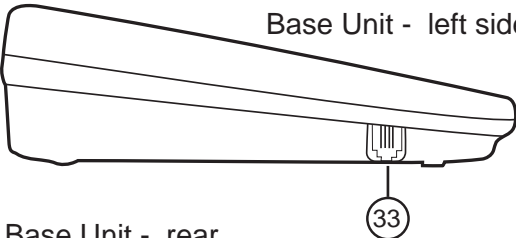

- 33 Handset cord jack

Base Unit - rear

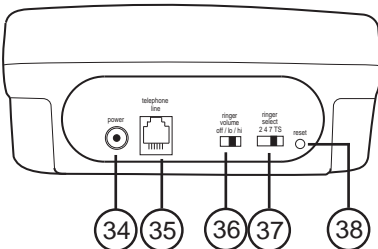

- 34 AC Adaptor plug
- 35 Telephone line connection
- 36 Ringer volume control
- 37 Answer machine ring select
- 38 Reset

CONTENTS

OF YOUR OWNERS MANUAL

CONTENTS

Controls and Functions	1
Contents	3
Quick Start Guide	4
Introduction	6
Features	6
Installation / Safety	6
Supplied with Your FP107	7
Wall Installation	8
Adjusting the Ringer Volume and Tone	9
Setting the Clock	9
Telephone Operation	10
Making a Call	10
Answering an Incoming Call	10
Using Flash	11
Using Hold	11
Using Mute	11
Memory Dialling	12
Storing a Number in Memory	12
Storing a Number from Caller ID Records	12
Entering a Pause in a Memory Number	13
Reviewing Memory Numbers	13
Dialling a Memory Number	13
Chain Dialling	14
Call Diversion	14
Telephone Answer Device	15
Recording Outgoing Messages	15
Checking te Outgoing Message	16
Using Toll Saver	16
Setting the FP107 to Answer Calls	16
Caller ID Operation	17
Name Tagging	17
Reviewing Caller ID Records	18
Deleting Call Records	18
FP107 Operation	19
Playing Messages	19
Deleting Messages	19
Screening Calls	19
Advanced Features	20
Setting the Display Contrast	20
Using Call Breakthrough	20
Remote Operation	20
Changing the Remote Operation Security Code	20
Remote Command List	21
Troubleshooting	22
Warranty	23

This page is a very condensed version of the Owners Manual. It is designed to allow you to get your phone installed and operating as quickly as possible - however it does not attempt to explain any of the advanced features of the FP107 .

Start Here!

1

2

3

Quick Start Guide

1

Installing the Base Unit

- Plug one end of the Handset curly cord into the handset and the other into the jack on the side of the telephone base.

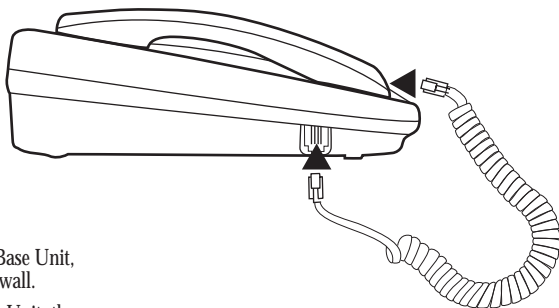

- Plug the Telephone Cord into the Base Unit, then into the Phone Socket on the wall.
- Plug the AC Adaptor into the Base Unit, then into the Power Point.

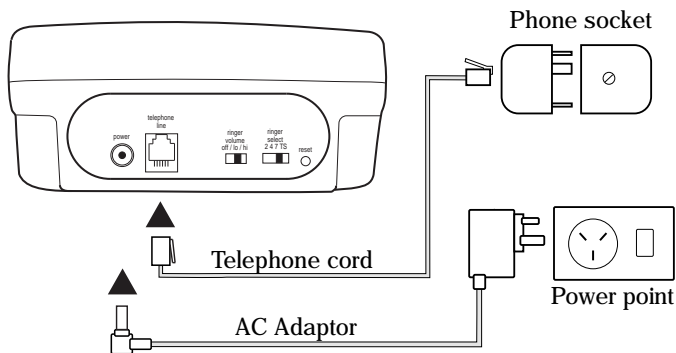

Make sure the AC Adaptor remains switched ON at all times.



2

Installing the Backup Battery

- Use a small Phillips screwdriver to remove the two screws on the battery compartment cover located under the base. Remove the cover.
- Plug the battery contacts in place and lay the battery in the battery compartment.
- Replace the cover and secure with the screws.

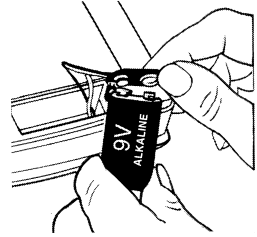
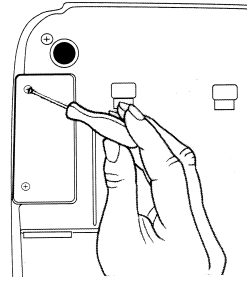

 This symbol on the display screen indicates the battery level is low. Disconnect the telephone line cord and replace it with a 9V alkaline battery.

3

Making a Call

- Pick up the handset
OR
Press **speaker**
Dial the number
- To hang up, replace the handset on the base - or press **speaker**

To Redial (last number dialed)

- Pick up the handset
OR
Press **speaker**
- Press **rdl/p**
The telephone will automatically redial the last number dialed.

Answering a Call

- Pick up the handset from the base and speak.
OR
Press **speaker** and speak



INTRODUCTION

TO YOUR NEW PHONE

FEATURES

- 1 12 Number Memory Dialling
- 1 Speakerphone
- 1 Flash
- 1 Mute
- 1 Hold
- 1 Pause
- 1 Redial
- 1 Volume Controls
- 1 Adjustable Ringer Volume
- 1 Hearing-Aid Compatible
- 1 Tone Dialing

ANSWER MACHINE FEATURES

- 1 Recordable Outgoing Message
- 1 Voice/Date/Time Stamp
- 1 Adjustable Ring Number
- 1 Toll-Saver
- 1 Phone Pick-Up Detection
- 1 Call Breakthrough (CBT) with Programmable Code
- 1 Call Screen
- 1 Remote Operation with Programmable Code
- 1 Room Monitor
- 1 Memory Backup

CALLER ID FEATURES

- 1 3-Line Display
- 1 Caller ID Memory
- 1 Call Summary
- 1 Name Tagging
- 1 New Call Indicator
- 1 Review Scrolling
- 1 Dialling Option

INSTALLATION & SAFETY

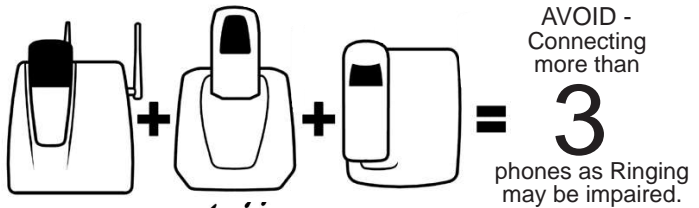

AVOID - moisture



DON'T - overload the power outlet OR plug into a multi power board.

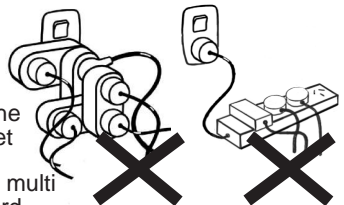

SUPPLIED WITH YOUR FP107

NOTE

To get the most from your purchase, please read the Owners Manual thoroughly. Also be sure to complete the Customer Support Card.

NOTE

If any of these items are missing or damaged, contact the place of purchase.

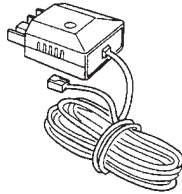

1 - Telephone line cord

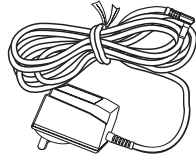

1 - AC Adaptor

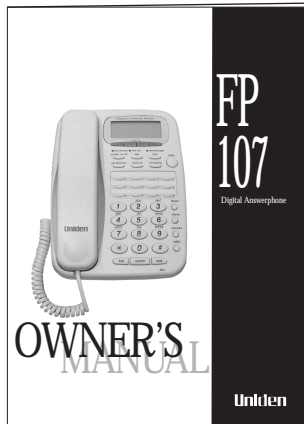

1 - Owners Manual
1 - Customer Support card

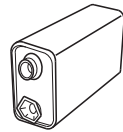

1 - 9V battery

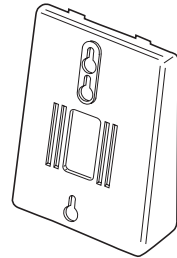

1 - Wall mount bracket
and 2 screws

WALL INSTALLATION

Wall Mounting

If required, you can mount your phone directly on a wall.

Before mounting your phone, please consider the following:

- Select a location away from electrical cables, pipes or other items behind the mounting location that could cause a hazard when inserting screws into the wall.
- Make sure the wall material is capable of supporting the weight of the telephone.
- Use the screws (supplied) with anchoring devices suitable for the wall material where the Telephone will be placed.

Insert two mounting screws 100mm apart.
Allow about 5mm between the wall and screw heads for mounting the phone.

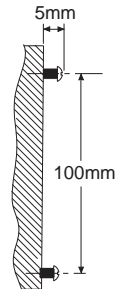

Attach the wall mounting bracket to the telephone base.

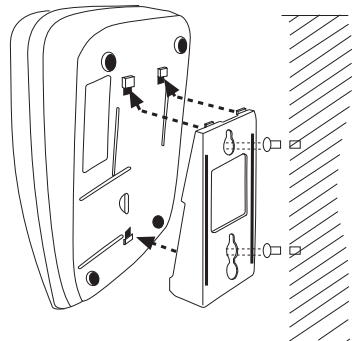

Place the base unit on the screws and push down until it is firmly seated.

Gently pull out the handset retainer tab, turn it 180° and refit it.

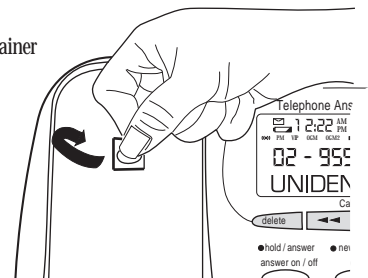

ADJUSTING THE RINGER VOLUME AND TONE

Ringer volume control

Locate the volume control switch at the rear of the base.

Slide the ringer volume switch to the desired off/lo/hi setting.

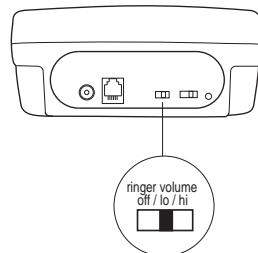

VOLUME CONTROL

Handset volume control

While using the phone you can adjust the handset volume with the control, located at the side of the base.

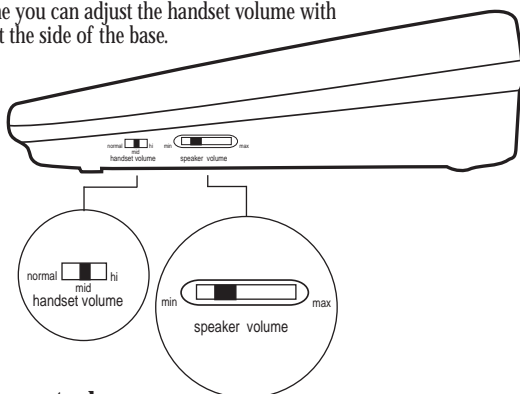

Speaker volume control

During a speaker phone conversation, you can adjust the speaker volume by sliding the control (located on the side of the base) until you hear the desired volume.

SETTING THE CLOCK

To avoid losing the day and time settings if AC power fails, we recommend you install a backup battery before you set the day and time (see "Installing a Backup Battery" on Page 5). Follow these steps so the FP107 can record the correct day and time each message and memo is recorded.

1. Hold down **(store)** until the FP107 beeps once.
2. Press **(store)** 3 times until SUNDAY appears.
3. Repeatedly press ***** or **#** to select AM or PM.
4. Press **(▶▶)**. The hour digit flashes.
5. Repeatedly press **(◀◀)** to set the correct hour.
6. Repeat Steps 4 and 5 to set the minute, month, date, and the day of the week.
7. Press **(store)**.

NOTE

If you do not complete each step within 8 seconds, the FP107 exits setup. Start again at Step 1.

TELEPHONE OPERATION

Making a Call

To make a call with the handset, pick up the handset. When you hear the dial tone, dial the phone number. DIALLING is displayed. You will see the number as you dial, then (after 8 seconds) the elapsed time of your call.

Press **speaker** to make a call using the speakerphone. SPEAKERPHONE is displayed. Dial the phone number, DIALLING is briefly displayed, followed by the number as you dial, then (after 8 seconds) the elapsed time is displayed.

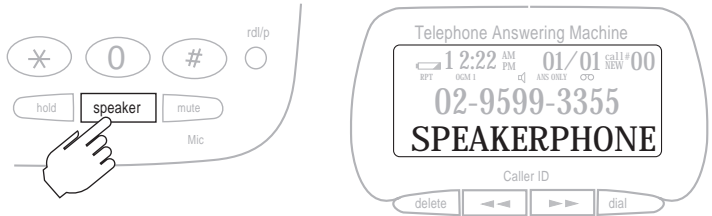

NOTE

If any background noise interferes with the speakerphone's operation, press **mute** to turn off the base's microphone while the other party is speaking.

Answering an Incoming Call

To answer an incoming call:

1. Pick up the handset
OR
Press **speaker**.

To end a call:

1. Place the handset back on the base
OR
Press **speaker**.

Using Redial

To redial the last number you dialed:

1. Lift the handset and press **rdl/p**
OR
Press **speaker**. Press **rdl/p**. The telephone will automatically redial the last number dialed

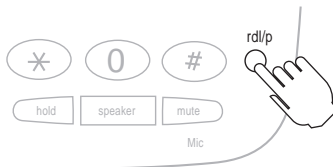



If you do not have special phone services, from your telephone company or PBX, pressing (flash) may disconnect the current call.



The FP107 will not show Caller ID information for an incoming call while another call is on hold.

Using Flash

Use (flash) to perform the hook switch operation for special services, such as Call Transfer on a business PBX.

Using Hold

To put a caller on hold, press (hold). The FP107 beeps, <HOLD> is displayed, and the hold/answer indicator flashes. You can now hang up the handset without disconnecting the call.

To resume the call:

Press (hold) again

OR

Lift the handset if the handset is placed on the base

OR

Pickup any extension phone on the same line.



Using Mute

To talk to someone else in the room without the person on the other end of the phone line hearing you, press (mute). The FP107 beeps, and <MIC MUTE> is displayed.

Press (mute) again to resume your conversation.

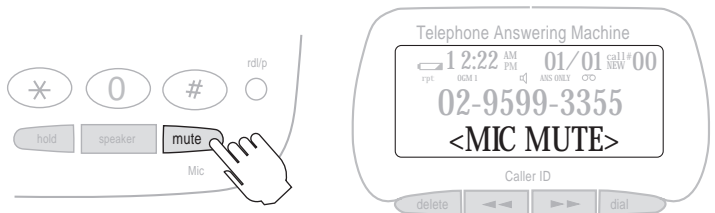

MEMORY DIALLING

NOTE

You must complete each step within 8 seconds.

NOTE

Store your area code with your number eg: 02, for name tagging to operate.

NOTE

If you make a mistake while entering the number, or name press  once then re-enter.

NOTE

To change a number or name in memory, store a new one in its place.

NOTE

To erase a memory press **(store)** 3 times, followed by the memory location you wish to delete.

You can store up to 12 numbers in memory and dial any stored number by pressing one key.

Storing a Number in Memory

There are 12 memory location buttons.

1. Press **(store)**. NUMBER? is displayed.

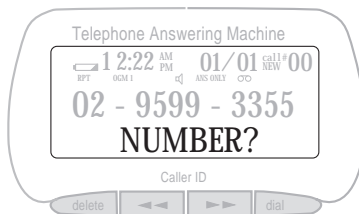
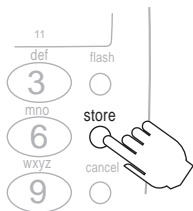

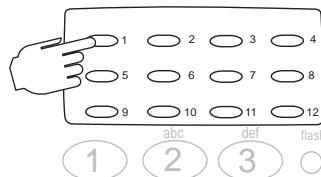

2. Enter the number you want to store.
3. Press **(store)**, NAME? is displayed.
4. Enter the name using the alpha keys.
5. Press **(store)** again. STORE TO? is displayed.

Press a memory location (1-12).



Storing Numbers from Caller ID Records

You can store a number from a Caller ID record.

1. Repeatedly press  or  to select the desired phone number.
2. Press **(store)** three times.
3. Then press a memory location key to store the number

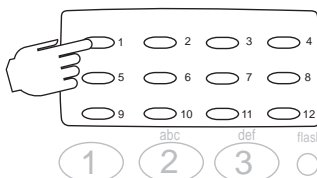



Each pause entry uses one digit of memory.

Entering a Pause in a Memory Number

The pause feature is useful for long distance calling or for access codes that require a pause between digits.

When storing a number in memory, press **(rdl/p)**. This enters a 2-second pause. P (pause) is displayed. For a long pause, press **(rdl/p)** again.



Reviewing Memory Numbers

To review stored numbers, press the memory location key (1 - 12). Only the first 12 digits of the phone number is displayed. To view the remainder press that location number button again.

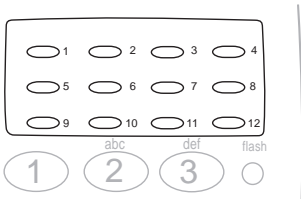

Dialing a Memory Number

There are two ways of dialing memory numbers.

1. Lift the handset or press **(speaker)**
2. Press the desired memory location key.

OR

Press the desired memory location key then press **(dial)**.



NOTE

For Call Waiting to operate, you must first subscribe to this service through your telephone company.

Chain-Dialling

For quick recall of numbers for special services, you can store each group of numbers in its own memory location. Then, when calling special services, dial the service's main number first. At the appropriate place in the call, press the memory location button for the additional numbers you want to send.

Call Waiting:

When the call waiting tone sounds, press **(call waiting)** followed by **(dial)**. This will switch between the original and incoming call.

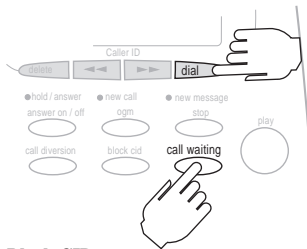

Block CID:

Each time you make a call, your telephone number is automatically forwarded to the party you are calling. You can use Block CID to prevent your number being sent.

1. Pick up the handset or press **(speaker)**.
2. Wait for the dial tone. Press **(block cid)** then press **(dial)**.
3. Dial the telephone number of the person you wish to call. Your telephone number will not be forwarded for this call only.

Call Diversion:

If your phone is not answered within 20 seconds (approximately 7 or 8 rings), it can be diverted to another number.

Pick up the handset

OR

Press the **(speaker)** button.

Wait for the dial tone, press **(call diversion)** - CALL DIVERT ON is displayed - then press **(dial)** and hang up.

The telephone will automatically dial the access code *61# and will enable the "Call Forward No Answer" feature, diverting unanswered calls to the fixed number you have previously assigned the divert to.

NOTE

For Call Diversion to operate, you must first subscribe to this service through your telephone company.

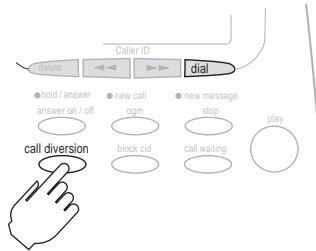

To Cancel 'Call Diversion'

1. Pick up the handset

OR

Press **speaker**.

2. Press **call diversion** - CALL DIVERT OFF is displayed - then press **dial** again and hang up.

The telephone will automatically dial the access code #61# and will cancel the diversion.



The maximum length for outgoing message is 60 seconds. As you record, the message counter shows the recording time.



OGM1 flashes on the display if an out-going message has not yet been recorded.

TELEPHONE ANSWER DEVICE

Recording Outgoing Messages

Before the FP107 can answer calls and record messages, you must record an outgoing message (OGM).

1. To record the OGM 1 message, hold down **ogm** until the timer starts counting. OGM1 RECORDING is displayed.
2. Speak clearly at about 20cm from the front of the FP107 the message that you want incoming callers to hear.
3. When you finish speaking, press **stop**. The FP107 beeps and plays back the outgoing message.

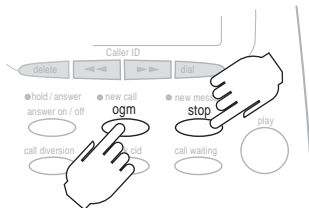



If the FP107 Answer Machine is off, after 15 rings it will automatically switch on and answer the call.



The maximum recording capacity is 16 minutes (or 68 recorded messages), or 86 Caller ID records.

Checking the Outgoing Message

To check an outgoing message, press **OGM**. OGM1 PLAYING appears and the message plays.

If no outgoing message is recorded when you press OGM1, the FP107 announces "You have no announcement one" and sounds four beeps.

Number of Rings

The FP107 can be set to 2, 4 or 7 rings before it answers the call and plays your message. The selector is located at the rear of the base unit.



Using the Toll Saver

If the ring select switch is set to TS (toll-saver), the FP107 answers after two rings if you have new messages. If there are no new messages, the FP107 answers after four rings. This gives you time to hang up before the FP107 answers so you can avoid unnecessary long-distance charges.

Setting the FP107 to Answer Calls

To turn on the FP107 and set it to answer calls and record messages, press the **answer on/off** once. The FP107 says "Answer on". ANS ON is displayed, the FP107 plays the outgoing message. The hold answer indicator lights to show that the FP107 is ready to answer calls.

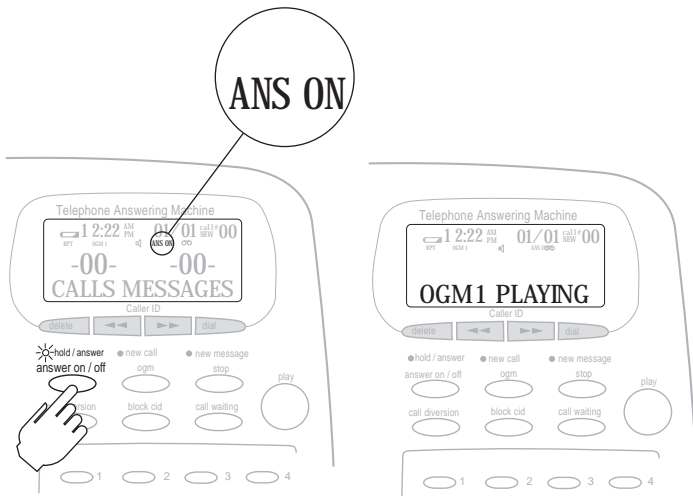

CALLER ID OPERATION

If you subscribe to Caller ID service from your phone company, the phone automatically displays the information the phone company sends between the first and second rings of every call you receive. It stores up to 86 numbers only or name and number call records in its Caller ID memory.

It also shows the date and time the call was received. The display also shows if caller information is not available or if the sender chose not to send the information.

The new call LED flashes during an incoming call, and the Caller ID record is displayed. The total Caller ID record is displayed for about 8 seconds, after the last ring stops.

If you receive more than one call (without an accompanying message) from the same phone number, RPT (repeat) is displayed, and the FP107 stores a single Caller ID record for that number with the date and time of the last call. Any call with a voice message will have a call ID record.

If only Caller ID records (both incoming messages and Caller ID records) are full, the FP107 announces "Memory is full", and CALLS MSG FULL appears. The FP107 answers calls after answer rings and plays "Message is full. Thank you for your call".

Caller ID Messages

Display	Description
-XX- -XX- CALLS MESSAGES	Appears as new calls are received. xx is the number of new calls.
PRIVATE	Appears when the caller has blocked the Caller ID information from being sent.
OUT OF AREA	Appears when the caller is not within a Caller ID service area. No caller information appears.
ERROR	Appears if there was an error during the transmission of Caller ID information.
END OF CALLS	Appears when you have reached the end of your call records.
TOP OF CALLS	Appears when you have reached the top of your call records.
RPT	Appears when you review a Caller ID record from someone who has called more than one time from the same number.

Name Tagging

If the caller ID telephone number **exactly** matches a number you have stored in memory, the name stored in memory will be displayed with caller ID numbers.

REVIEWING CALLER ID RECORDS

NOTE

The FP107 returns to the time/date display after 8 seconds if you do not press a key.

NOTE

You can review the Caller ID information, but cannot play the messages when the handset is off the cradle or the speakerphone is in use.

NOTE

The FP107 will not delete Caller ID records or messages that have not been reviewed or played. You cannot delete Caller ID records during a call.

Each time you receive a call, the FP107 stores a Caller ID record that you can review later, even during a call.

A Caller ID record includes:

- Call number
- Time and date of the call
- Callers' telephone number (if available)
- Caller's name (if available)
- Voice message (if the calling party leaves a message)

Repeatedly press  to see more recent call records or  to see older call records.





To review the new call only, hold down  or  until the new call appears.

If you receive a call with a message,  flashes on the display. To play a specific message, repeatedly press  or  until the selected Caller ID information appears, then press . To play all messages, press  only.

Deleting Call Records



Deleting a Single Call

To delete a specific call record, repeatedly press  or  until the call you want to delete appears. Then press .





To delete a call that has a message, repeatedly press  or  until the desired call appears. Press  to play the message, then press  during the playback.

After the message is deleted, press  to delete the Caller ID record.

Deleting All Calls

To delete all calls, press and hold  on the current date/time display until **dEL ALL** appears, then press . To return to the current time display, wait for seconds, or press .

Using Dial

1. Repeatedly press  or  to select the desired phone number.
2. To callback a phone number from Caller records with the speakerphone, press 
OR
To call back a phone number from Caller ID records with the handset, pick up the handset then press .

FP107 OPERATION

Playing Messages

The FP107's message window shows the total number of messages, both old and new. If there are new messages, the new message LED flashes.

To play all messages, press (play).

To adjust the FP107's volume, slide the speaker volume min/max on the right side of the phone.

To play only new messages, hold down (play) for 2 seconds.

To replay a message while you are listening to it, press (◀▶). The current message replays from the beginning.

To select another message, press (◀▶) or (▶▶) until the desired message number appears in the display.

To pause while listening to messages, press (play). PAUSE is displayed. To resume playback, press (play) again within 60 seconds.

To stop playback, press (stop). The FP107 beeps, says "End of messages" and END OF MESSAGES is displayed. The FP107 then resets to answer calls.

Deleting Messages

To delete a specific message, press (delete) while the message is playing.

To delete all messages, stop playback and hold down (delete) until dEL ALL appears, then press (◀▶).

The TAD does not delete new messages.

Screening Calls

To screen calls, let the FP107 answer them. TAD IN USE is displayed.

Listen to the caller's message through the FP107's speaker. To adjust the volume, slide speaker volume - min / max on the right side of the FP107.

If you decide to answer the call, pick up any phone on the same phone line as the FP107. The FP107 stops recording and resets to answer the next call.

If you do not want to take the call, let the FP107 finish recording the caller's message.

NOTE

If you answer the phone just as the TAD answers, the TAD may not stop playing the outgoing message. If this occurs, simply press (stop).

ADVANCED FEATURES



NOTE

The FP107 has ten (0-9) display contrast settings.

Setting the Display Contrast

1. Hold down **(store)** until the FP107 beeps once. 5 and LCD CONTRAST appear. 5 flashes.
2. Repeatedly press **(←)** or **(→)** to select the desired display contrast settings.
3. Press **(store)** to confirm the setting, then press **(stop)** to return to the time display.

Using Call Breakthrough

If you screen your calls but want to know when calls come in from certain people, give them your Call Breakthrough (CBT) Code.

When a caller enters the CBT code during the outgoing message (168 factory preset), the FP107 alerts you with a series of loud beeps for 35 seconds. To answer the call, pick up the handset or press **(speaker)**. If you do not answer, the caller can leave a message after the outgoing message plays.

Changing the CBT Code

The CBT code is preset to 168, but you can change it by following these steps:

1. Hold down **(store)** until the FP107 beeps once.
2. Press **(store)** two times. 168 and SET CBT CODE are displayed.
3. Enter the new 3 digit code.
4. Press **(store)** then press **(stop)** to return to the time display.



NOTE

If you do not complete each step within 8 seconds, the FP107 exits setup. Start again from Step 1.

Remote Operation

You can operate the FP107 from almost any touch-tone phone or from a rotary phone using a pocket tone-dialer.

Follow these steps to operate the FP107 remotely.

1. Dial your phone number from another phone.
2. When the FP107 answers, enter your remote operation security code (705 factory preset). The FP107 beeps once to confirm that you entered the correct code.
3. Enter a remote command (see "Remote Command List").
4. When you finish, hang up.



NOTE

If the FP107 Answer Machine is off, after 15 rings it will automatically switch on and answer the call.



NOTE

If you do not enter a digit within 8 seconds, the FP107 hangs up.

Changing the Remote Operation Security Code

The FP107's remote operation security code is preset to 705, but you can change it by following these steps.

1. Hold down **(store)** until the FP107 beeps once.
2. Press **(store)** once. 705 and SECURITY CODE are displayed. 7 flashes.
3. Enter the new 3 digit code.
4. Press **(store)** then press **(stop)** to return to the time display.

REMOTE COMMAND LIST

Press	To
00	Set the FP107 to not answer calls.
01	Set the FP107 to answer calls.
21	Play all messages.
22	Announce all Caller ID records.
31	Play new messages. .
32	Announce new Caller ID information.
4	Monitor the room for 20 seconds. Press 4 to repeat monitoring.
5	Delete all messages (except new messages). The FP107 says "Erase", then press 1
5	Delete all Caller ID calls (except new Caller ID calls). The FP107 says "Erase", then press 2
6	Stop playback or recording.
8	Change OGM 1. After the FP107 beeps, begin speaking. When you finish, press 6.
9	Play OGM 1.

After pressing 21, 22, 31, or 32 to play Caller ID records/messages remotely, you can

Press	To
1	Replay the previous Caller ID record or message.
3	Skip to the next Caller ID record or message.
4	Replay the current Caller ID record or message.
5	Delete the current Caller ID record or message.
6	Stop message playback.

QUICK REFERENCE CHART

If your phone is not performing to your expectations, please try these simple steps first before calling Uniden customer service -

PROBLEM	SUGGESTION
No dial tone	Check that the phone line cord connectors at both ends are pushed in until they click.
Does not ring	You may have exceeded the limit of the number of phones that can be connected to the same line, unplug some phones. Check the ringer volume switch position is not off.
Speakerphone will not work	Check the AC Adaptor is plugged in and switched on.
No LCD display	Check the AC Adaptor is plugged in and switched on.
new call light flashes continuously	Review all New Calls. Press Reset.
Cannot delete all messages or records	Review all New Messages and Caller ID Records. Press Reset .

WARRANTY

One Year Limited Warranty

Important: Evidence of original purchase is required for warranty service.

Warrantor: Uniden Australia Pty Limited A.B.N. S8 001 865 498
Uniden New Zealand Limited

ELEMENT OF WARRANTY: Uniden warrants to the original retail owner for the duration of this warranty, its FP107 (herein after referred to as the Product), to be free from defects in materials and craftsmanship with only the limitations or exclusions set out below.

WARRANTY DURATION: This warranty to the original retail owner only, shall terminate and be of no further effect 12 months after the date of original retail sale. This warranty will be deemed invalid if the product is; (A) Damaged or not maintained as reasonable and necessary, (B) Modified, altered or used as part of any conversion kits, subassemblies or any configurations not sold by Uniden, (C) Improperly installed, (D) Repaired by someone other than an authorised Uniden Repair Agent for a defect or malfunction covered by this warranty, (E) Used in conjunction with any equipment or parts or as part of a system not manufactured by Uniden. (F) Only available in the original country of sale.

PARTS COVERED: This warranty covers for one (1) year, the Base and Handset only. All accessories (AC Adaptor, Wall mount bracket, etc.) are covered for 90 days only.

STATEMENT OF REMEDY: In the event that the product does not conform to this warranty at any time while this warranty is in effect, the warrantor at its discretion, will repair the defect or replace the product and return it to you without charge for parts or service. **THIS WARRANTY DOES NOT COVER OR PROVIDE FOR THE REIMBURSEMENT OR PAYMENT OF INCIDENTAL OR CONSEQUENTIAL DAMAGES. THIS GUARANTEE IS IN ADDITION TO AND DOES NOT IN ANY WAY AFFECT YOUR RIGHTS UNDER THE CONSUMER GUARANTEE ACT.**

PROCEDURE FOR OBTAINING PERFORMANCE OR

WARRANTY: In the event that the product does not conform to this warranty, the Product should be shipped or delivered, freight pre-paid, with evidence of original purchase (eg. a copy of the sales docket), to the warrantor at:

UNIDEN AUSTRALIA PTY LIMITED
SERVICE DIVISION
345 Princes Highway,
Rockdale NSW 2216
Ph (02) 9599 3577 Fx (02) 9599 3278
Toll Free 1300 366 895

www.uniden.com.au

UNIDEN NEW ZEALAND LIMITED
SERVICE DIVISION
150 Harris Road,
East Tamaki, Auckland
Ph (09) 273 8383 Fx (09) 274 4253
Toll Free 0800 4 UNIDEN
(864 336)

www.uniden.co.nz

Customers in other States should ship or deliver the Product freight pre-paid to their nearest Uniden Authorised Repair Centre. See Unidens Website for the nearest Repair Centre.

NOTES



NOTES



NOTES



THANK YOU

FOR PURCHASING A UNIDEN PHONE!

Uniden

© 2001 Uniden Australia Pty Limited
Uniden New Zealand Limited

Free Manuals Download Website

<http://myh66.com>

<http://usermanuals.us>

<http://www.somanuals.com>

<http://www.4manuals.cc>

<http://www.manual-lib.com>

<http://www.404manual.com>

<http://www.luxmanual.com>

<http://aubethermostatmanual.com>

Golf course search by state

<http://golfingnear.com>

Email search by domain

<http://emailbydomain.com>

Auto manuals search

<http://auto.somanuals.com>

TV manuals search

<http://tv.somanuals.com>