



LRD 747

LRD 757

# REFERENCE GUIDE

The industry's most  
advanced fully integrated  
laser/radar detectors.

# THANK YOU

FOR PURCHASING A UNIDEN PRODUCT!

## Uniden®

Covered under one or more of the following U.S. patents:

4,622,553 4,698,632 4,709,407 4,791,420

4,831,498 5,315,302 5,469,287 5,579,012 5,835,052

Download from [www.Somanuals.com](http://www.Somanuals.com). All Manuals Search And Download.

All rights reserved • Printed in the Philippines

# CONTENTS

## OF YOUR REFERENCE GUIDE

### CONTENTS

<b>Introduction</b> .....	<b>2</b>
Feature Highlights .....	2
Included with Your Radar Detector .....	3
<b>Speed Detection</b> .....	<b>4</b>
Speed Detection Systems .....	4
Radar .....	4
Laser .....	5
<b>Controls</b> .....	<b>6</b>
Controls and Functions .....	6
LED Panel .....	7
<b>Installation</b> .....	<b>8</b>
Helpful Tips .....	9
Adjusting the Windshield Mounting Clip .....	10
Connecting the Power .....	11
Replacing the Fuse .....	12
<b>Operation</b> .....	<b>13</b>
Power On .....	13
Volume Control .....	13
Memory Retention Feature .....	14
Full Warning .....	14
Audio Alert Only Operation .....	14
Visual Alert Operation .....	15
Auto Mute Operation .....	15
City Operation .....	16
LED Signal Strength Meter in City Mode .....	17
Safety Warning System Operation .....	17
Care and Maintenance .....	18
<b>Troubleshooting</b> .....	<b>19</b>
<b>Specifications</b> .....	<b>20</b>

NOTE: Foldout the back cover of this reference guide to refer to the “Controls & Functions” page.

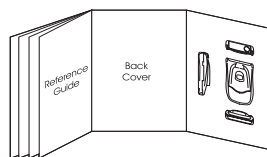

# INTRODUCTION

## TO YOUR NEW LASER/RADAR DETECTOR

### INTRODUCTION

Welcome to the world of sophisticated, early warning laser/radar detection. You have purchased one of the most advanced laser/radar detectors available. The LRD 747/LRD 757 is a completely integrated laser/radar detector. It responds to the X-, K-, and Ka-SuperWideband radar guns in use today and also provides 360° detection of the latest speed monitoring system – the laser gun. The built-in Safety Warning System (SWS™) is capable of detecting a hazardous warning signal transmitted on the K-band.

The LRD 747/LRD 757 provides distinct visual and audio alerts to warn you of the presence of X-, K-, and Ka-SuperWideband radar signals as well as IR laser signals. You can drive with confidence when you bring along the LRD 747/LRD 757.

The LRD 747/LRD 757 employs Super Stalker Technology (SST), a state-of-the-art electronic system designed to make this radar detector invisible to all current VG-2 radar detector detectors. The LRD 747/LRD 757 also uses the new D.R.O. (Dielectric Resonant Oscillator) and E.D.I.T. (Electronic Data Interference Terminator) circuitry, giving more reliable performance.

We are certain that you will enjoy the LRD 747/LRD 757, and to ensure that you get the most from its features, please read this Reference Guide carefully before installing and operating the unit.

### FEATURE HIGHLIGHTS

- 360° Laser Detection
- Safety Warning System™
- All Band Coverage
- 7 Alarm Tones
- Super Wideband
- VG-2 Undetectable
- K/Ka Priority
- Pulse Detection
- Signal Strength Meter
- Warning Lights
- Visual Only Mode
- Auto Mute Mode
- Audio Only Mode
- Self Test
- Memory Retention Feature
- City and Highway Modes

**TIP**

To get the most from your laser/radar detector, please read this Reference Guide thoroughly.

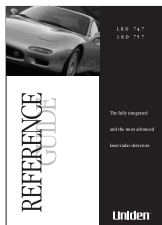
**INCLUDED WITH YOUR RADAR DETECTOR**

Reference Guide

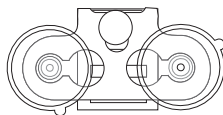

Windshield Clip



Printed Material

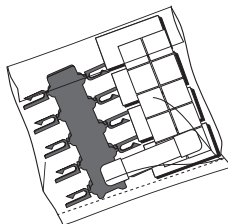

Fuses and Spare Parts

**WARNING**

If any of these items are missing or damaged, contact your dealer immediately. Be sure to complete and mail the product registration card. Included with your radar detector.

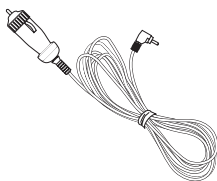
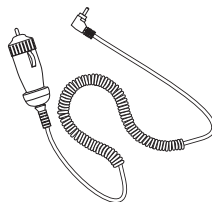
Straight Power Cord  
LRD 747 OnlyCoiled Cigarette Adapter  
LRD 757 Only

### SPEED DETECTION SYSTEMS

A speed detection device (often called a radar gun) sends out either a microwave signal or beam of light. When this signal reaches its target, part of the signal is reflected or bounced back toward the emitting gun. The time required for the signal to leave the gun, bounce off an object, and return is used to determine a vehicle's distance and speed.

#### ▼ *RADAR*

Radar (Radio Detection and Ranging) is a microwave system for detecting the speed of moving objects by reflected pulses of high frequency radio waves. There are three radar bands (microwave frequencies): X band (10.49 to 10.56GHz), K band (24.04 to 24.26GHz), and the "superwide" Ka band (33.4 GHz to 36 GHz).

The X band was the first used for traffic, followed by the K band which is harder to detect (most instant-on radar is K band). The Ka band was introduced in 1987, and widened to Ka SuperWideband in 1990 by the FCC. The LRD 747/LRD 757 monitors all current radar bands including the entire Ka SuperWideband.

The radar beam is cone shaped – the narrower the beam, the greater the resolution. A moving vehicle reflects radar signals back towards the radar gun. The LRD 747/LRD 757 can detect the signals emitted by radar guns, and it will sound an audio alarm and flash a warning indicator. For continuously transmitting radar, use the LRD 747/LRD 757 to get accurate detection from a safe distance. Weak signals cause the audio and visual alarms to sound intermittently, but as the signal gets stronger (the closer you get to the radar gun), both alarms increase in intensity.

Instant-on transmitters fire a short radar pulse beam at a vehicle and instantly read its speed. When detected at a distance, you will hear a few beeps and see the strength meter begin to light. Instant-On radar signals are the most difficult to detect at a safe distance because they are transmitted only when directed at you or at a vehicle directly ahead of you.

## ▼ LASER

The Laser Speed Detection System, also called LIDAR (for Light Detection and Ranging), uses a laser gun that emits infrared light pulses just outside the spectrum of visible light. Each reflected pulse measures the speed of the object coming toward or going away from the laser gun.

### CAUTION

To be safe, do not ignore any warnings. Although there are other types of radar signals that may cause interference, when the LRD 747/LRD 757 detects a signal, be on the alert. It is important to exercise caution at all times.

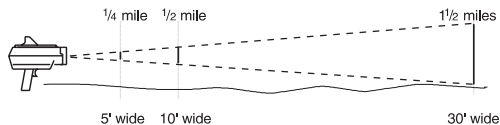

Unlike radar, the laser gun emits a very narrow beam of light, so it can pinpoint a speeding car within traffic. The infrared beam spreads out, but slowly and over a longer distance than a radar signal.

The laser gun can acquire a speed reading as quickly as 0.3 seconds, sometimes less. However, since it isn't easy to accurately aim at and hit a moving target, an operator often moves the laser gun in several directions to get a reading. So laser signals are emitted continuously for a few seconds for each speed measurement.



The LRD 747/LRD 757 can detect these light pulses from as far away as 1.5 miles, which is about four times the effective range of a laser gun (2,000 feet), and about ten times its average operating range (500-800 feet).

### CONTROLS AND FUNCTIONS

1. Clip Release – Press the clip release button to remove the LRD 747/LRD 757 from the windshield mounting clip.
2. Rear and Side Laser Detector Lens – For rear and side detection of laser signals.
3.  Press the **city** button to help reduce X-band false alarms while driving in the city. When you turn on the City Mode, the City indicator turns on. While driving on highways, turn off the City Mode for long-range detection.
4.  Press the **audio** button to activate the Audio Alert Only operation. All the LEDs dim, and the signal strength meter is disabled.
5.  Press the **mute** button to activate the Auto Mute feature, which produces a full alert level when a signal is first received, then automatically reduces to chirps for the rest of the warning.
6. Speaker – Sounds audio alert. There are six different audio alert tones to distinguish each type of signal received. When you become familiar with all the distinct alert tones, you can operate the LRD 747/LRD 757 just by listening, devoting your full attention to the traffic in front of you. DC 12V Power Input – Connect the DC power cord here.
7. DC 12V Power Input – Connect the DC power cord here.
8. On-Off/Volume Control – Turns the power on and adjusts the Audio Alert volume.
9. LED Panel – LEDs display visual alerts, signal strength, and operation mode.

NOTE: Foldout the back cover of this reference guide to refer to the “Controls & Functions” page.

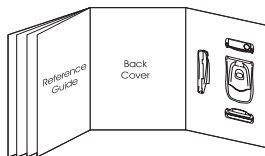



## LED PANEL

### HINT

Every time you turn on the LRD 747/LRD 757, a self test is performed for all LEDs and Alert tones. You will hear, in-order, four distinct tones for the X-, K-, and Ka-SuperWideband radar bands, as well as for laser, laser L2 and SWS.

- D1) X-Band Signal Indicator – A green LED lights and blinks to indicate the presence of an X-band radar signal. The blink rate increases as the radar source gets closer. A distinct audio alert is also heard.
- D2) K-Band Indicator – An amber (orange) LED lights and blinks to indicate the presence of a K-band radar. The blink rate increases as the radar source gets closer. A distinct audio alert is also heard.
- D3) Ka-SuperWideband Signal Indicator – A red LED lights and blinks to indicate the presence of a Ka-SuperWideband radar signal. The blink rate increases as the radar source gets closer. A distinct audio alert is also heard.
- D4) Power-On Indicator – A green LED under P lights to indicate power is being supplied to the unit and the unit is turned on.
- D5) LED Signal Strength Meter – Three LEDs give an accurate visual indication of the strength of radar or laser signals.
- D6) City Mode Indicator – A green LED under **C** lights to indicate that you selected City Mode.
- D7) Auto Mute Indicator – A red LED under **M** lights to indicate that you selected the Auto Mute feature. LED Signal Strength Meter – Three LEDs give an accurate visual indication of the strength of radar or laser signals.
- D8) Laser Signal Indicator – For laser signals, a red LED under **L** lights and blinks to indicate the presence of a laser signal. For the UltraLyte laser gun, an amber LED under **L** lights and blinks to indicate the presence of a UltraLyte laser signal. A distinct audio alert is also heard.
- D9) SWS Signal Indicator – When an early warning hazard or informational signal is detected, the green SWS LED begins to blink. A distinct audio alert is also heard.
- D10) VG2 Signal Indicator – A rapid flashing red and green LED indicates the presence of a VG2 signal.

NOTE: Foldout the back cover of this reference guide to refer to the “Controls & Functions” page.

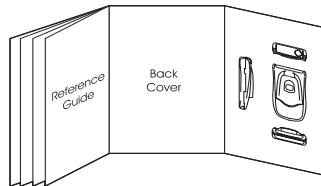

# INSTALLATION

## OF YOUR NEW LASER/RADAR DETECTOR

### INSTALLATION

The LRD 747/LRD 757 uses a highly sensitive horn-type antenna and IR laser sensor to receive laser/radar signals. Its sensitivity and range depend on the method of installation and the direction of the antenna/sensor in relation to the signal source. The inherent nature of radar waves makes them reflect off metallic surfaces. This is why these waves are so useful for measuring the speed of a vehicle. The IR laser light may reflect only from shiny surfaces. Both radar waves and IR laser light will, however, pass through plastic or glass.

Before you decide where to put your radar detector, please keep in mind these two important factors:

- For safety, do not mount the LRD 747/LRD 757 in a location where it will obstruct your driving vision.
- Most vehicles have the top part of the windshield tinted. Mounting the LRD 747/LRD 757 behind tinted or mirrored glass may reduce the effectiveness of laser detection by reducing the amount of laser light received by the detector.

**HELPFUL TIPS**

The antenna and the forward looking sensor are located behind the rear panel of the unit, (and the rear- and side-looking sensors are located on top of the unit), directly behind the mode selection keys. The antenna and sensors should not be obstructed by metal or metallic surfaces and should be pointed at the horizon for accurate long-range detection.

- Do not mount the unit behind the windshield wiper blades, radio antenna, tinted glass area, or mirrored glass. Be sure the unit is free from obstruction by seat backs, rear view mirror, sun visors, or the ceiling of the automobile.
- Do not mount the unit in front of the heater or defroster vents.
- Do not leave the unit in direct sunlight or in the glove compartment of a closed car for long periods of time, as extreme changes in temperature may cause internal damage. Also, removing the unit from the windshield makes you less susceptible to break-in and theft.



## ADJUSTING THE WINDSHIELD MOUNTING CLIP

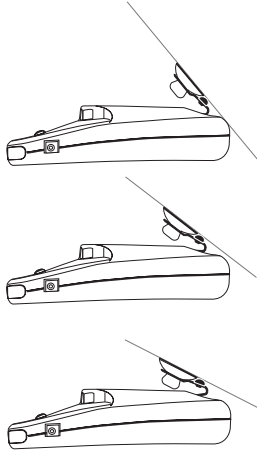

- 1) The metal portion of the bracket locks into the plastic portion at three different positions. These positions can be used for vehicles with different vertical angles of their windshields. The back position can be used for vehicles with windshields that are slanted back
- 2) For optimum laser detection, bend the angled portion of the windshield mounting bracket so that the LRD 747/LRD 757 is parallel to the road surface. Be sure the LRD 747/LRD 757 is mounted so it is free of obstructions from seat backs, rear view mirror, sun visors, or the ceiling of the automobile. There must be a clear 360° line of sight to the outside of the vehicle.

### **To mount the LRD 747/LRD 757:**

- 1) Press the button on top of the radar and insert the windshield clip into the LRD 747/LRD 757. The metal portion of the bracket locks in to the plastic portion.
- 2) Place the bracket and the LRD 747/LRD 757 in the proper location on the windshield of your vehicle, and press the suction cups firmly against the windshield.

**TIP**

Use only a Uniden supplied power cord or its replacement.

**CONNECTING THE POWER**

The LRD 747/LRD 757 is designed to operate on most 12 VDC negative ground vehicle electrical systems. The power cord provided with the unit has a cigarette lighter socket plug at one end and a small connector at the other.

- 1) Insert the small connector into the jack on the side of the unit.

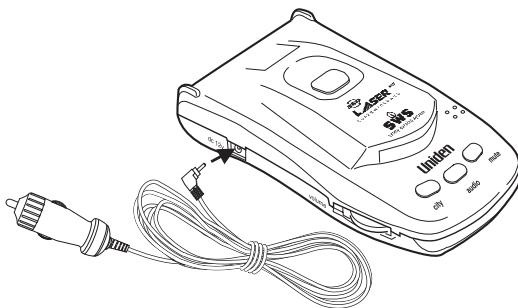

- 2) Insert the other end into the cigarette lighter socket of your vehicle.

When installing the power cord, make sure that:

- The socket is clean to allow proper contact.
- The power cord does not block the antenna area on the back of the unit.

Your unit also comes with ten power cord mounting clips. You can use these clips to attach the power cord to the window frame or other parts of the vehicle, keeping it neat and out of the way. Use the double-sided foam tape squares to attach each clip. Slip the power cord into the clip to hold it securely in place.

## REPLACING THE FUSE

The cigarette lighter plug contains a 1-ampere fuse to protect it from power surges.

1. To replace the fuse, unscrew the top of the plug.

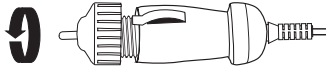

2. Remove the fuse and replace it with the same type.

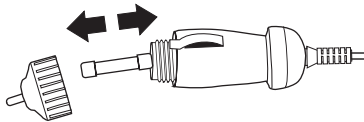

3. To replace the top, push in the two metal contacts and twist into place.

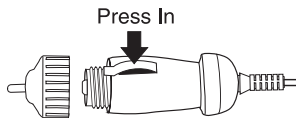

### OPERATION

You are now ready to enjoy the convenience and security of your LRD 747/LRD 757. Please read this section of the Reference Guide carefully to familiarize yourself with the basic operation of this unit.

### POWER ON

Turn the **volume** control to switch on the power. When you power up the LRD 747/LRD 757, it performs a self-test of all its circuits. This test takes about 5 seconds, during which you will hear the different alarm tones and see all the LEDs. First, you will hear the X-band alarm for 2 seconds while the X-band indicator lights. The test also checks the signal meter LEDs. It is best to adjust the audible alarm during the self-test. Next you'll hear the K-band alarm while the K-band indicator and City LED lights, Ka-SuperWideband alarm while the Ka-Band indicator and mute LED lights. The laser alarm and the SWS alarm will each alarm for 1 second, while the City and Mute LED light. The VG2 alarm will alarm for 2 seconds while the City and Mute LED light. (The power LED remains on until you turn off the unit.) When turned on the LRD 747/LRD 757 always returns to its last setting.

After the LRD 747/LRD 757 confirms proper operation, the alert tones and all LEDs, except the green Power LED, turn off. If the Power LED does not light, check the cigarette lighter socket connection. If the unit turns on and off intermittently, or the alert tone sounds too often for no reason, check the power cord connection at both ends to be sure it is not loose.

### VOLUME CONTROL

Adjust the **volume** control to a comfortable alarm tone level for your vehicle. The volume level does not have any effect on the unit's sensitivity. It is best to adjust the audible alarm during the self-test.

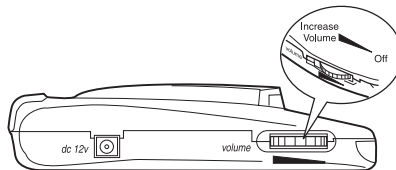

## MEMORY RETENTION FEATURE

The Memory Retention Feature retains the LRD 747/LRD 757's operational settings in memory for at least 2 days without power. When you turn on the LRD 747/LRD 757, it will be in the same mode as when you turned it off.

## FULL WARNING

When the LRD 747/LRD 757 detects a radar, laser, or safety warning signal, it emits a distinct warning tone and the corresponding alert LEDs (**X, K, Ka, L, SWS or VG2**) will light and blink. The blink rate of the LEDs increases and the signal strength meter LEDs light successively as the signal source comes closer.

## AUDIO ALERT ONLY OPERATION

Press the **audio** button for Audio Alert Only operation.

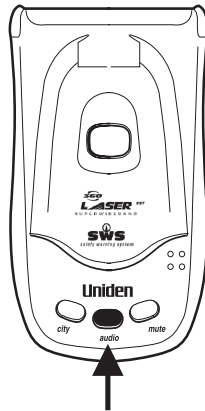

When Audio Alert Only is selected, the visual alert and signal strength meter are disabled. In this mode, all lighted LEDs will dim. Press the **audio** button again for the Full Alert (audio and visual) Mode. Do not set the Volume control at minimum when in Audio Alert Only because there will be no alert.



## WARNING

To operate with visual alert only, set the volume control to the minimum.

Remember though, if the volume control is turned down and Audio Only operation is selected, the alarm features are completely disabled.

## VISUAL ALERT ONLY OPERATION

You can operate the LRD 747/LRD 757 in Visual Alert Only by setting the **volume** control at the minimum position in Full Alert Mode. At this setting you can barely hear the audio alert in a quiet environment. Be sure that the Audio Alert Only indicator is off.

## AUTO MUTE OPERATION

Press the **mute** button to activate the Auto Mute feature.



When the Mute Indicator is selected, the unit is in Auto Mute Mode. In this mode you hear the full audio alert when a signal is first received. The audio alert automatically reduces to a chirp for the duration of the warning.

## CITY OPERATION

In highly populated areas, you may encounter many devices that use the same frequencies as radar signals, such as motion detectors, automatic doors, and intrusion alarms. These devices may trigger an alert called “falsing.”

To filter most of the weaker signals and get the most accurate radar signal recognition, press **city** to turn on the City Mode.

### TIP

If you use both the Audio Only Alert and City modes, you won't receive an audio alert until you are very close to the radar source.

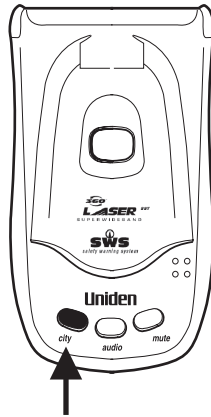

The City indicator lights.

In City Mode, the combination of visual and audio alert tones varies based on the strength of the received signal.

## LED SIGNAL STRENGTH METER IN CITY MODE

The LED signal strength meter gives you instant information about the strength of the signal being detected. A weak signal causes the first LED to light, but as signal strength increases, more LEDs light. All three LEDs light when full signal strength is received. Use this meter to judge the distance from the signal source.

Signal Strength	X-, K-, and Ka-Super WideBand	Laser
●○○	Visual	Visual/Audio
●●○	Visual/Audio	Visual/Audio
●●●	Visual/Audio	Visual/Audio

## SAFETY WARNING SYSTEM OPERATION

The Safety Warning System (SWS™) is a new communication system that will provide an early warning when a road hazard exists. The LRD 747/LRD 757 is capable of detecting the SWS signal broadcast on the K-band by either law enforcement or local departments of transportation. The green SWS LED blinks while an audible alert sounds. When this alert sounds, you should tune to local radio traffic reports or prepare to slow down or stop your vehicle because you could be approaching an accident, bad road conditions caused by weather, or road crews or construction.

# CARE & MAINTENANCE

## OF YOUR NEW LASER/RADAR DETECTOR

### CARE AND MAINTENANCE

The LRD 747/LRD 757 is designed to give you years of trouble-free service. There are no user-serviceable parts inside, and, except for the fuse, no maintenance is required. To keep your detector in new condition, follow these important suggestions:

- Never leave the LRD 747/LRD 757 on the windshield when you park your vehicle. The temperature in the vehicle in summer can reach levels above what is considered to be safe for this unit.
- To make you less susceptible to break-in and theft, remove the unit from your windshield when you leave your vehicle.
- Do not expose the unit to moisture. Rain, dew, road splash, or other liquids can damage the internal components and reduce sensitivity of the LRD 747/LRD 757.

# TROUBLESHOOTING

## OF YOUR NEW LASER/RADAR DETECTOR

### TROUBLESHOOTING

If your LRD 747/LRD 757 does not perform up to expectations, try the suggestions listed below. If you cannot get satisfactory results, call the Uniden Customer Service Center at (800) 297-1023, 7:00 a.m. to 7:00 p.m. Central Time, Monday through Friday.

Unit does not operate (Power LED not on).	<ul style="list-style-type: none"><li>• Check the power cord. Be sure the connectors are properly installed.</li><li>• Be sure ignition key is ON or in the accessory position.</li><li>• Fuse out. Check and replace.</li><li>• Check power to lighter socket.</li><li>• Vehicle electrical problem exists.</li><li>• Make sure that the volume control is in the ON position.</li><li>• Clean cigarette lighter socket.</li></ul>
Unit fails the self test.	<ul style="list-style-type: none"><li>• Call Uniden Customer Service Center, (800) 297-1023.</li></ul>
Weak detection.	<ul style="list-style-type: none"><li>• Check angle of unit. Point to the horizon.</li><li>• Antenna/Sensor is obstructed. Move the unit clear of any obstruction outside the windshield, such as a wiper blade.</li><li>• Move the unit clear of the window tint.</li></ul>
Inaccurate or erratic detection:	<ul style="list-style-type: none"><li>• Loose power cord. Check both connectors.</li><li>• Power cord is broken. Check and replace.</li></ul>
Beeps over bumps or rough road.	<ul style="list-style-type: none"><li>• Check that the power cord is connected at both ends.</li><li>• Clean cigarette lighter socket.</li></ul>
Beeps at same location.	<ul style="list-style-type: none"><li>• Falsing because you have passed a motion sensor or alarm.</li></ul>
Signal strength meter registers, but no audio.	<ul style="list-style-type: none"><li>• For highway use, make sure the City Mode is OFF.</li><li>• Increase the volume.</li></ul>
The unit bounces against the windshield.	<ul style="list-style-type: none"><li>• Reposition the unit so that the bumpers are firmly against the windshield.</li></ul>

# SPECIFICATIONS

## OF YOUR NEW LASER/RADAR DETECTOR

### General

Dimensions:	3 $\frac{1}{9}$ in. (W) x 4 $\frac{5}{8}$ in. (D) x $\frac{5}{16}$ in. (H)
Weight:	3.5 oz
Power Requirements:	13.8 VDC
Temperature Range:	Operating: -5°F to 160°F (-20°C to 70°C) Storage: -40°F to 185°F (-40°C to 85°C)

### 360° Laser Detector

Receiver Type:	Pulse Laser Signal Receiver
Sensor Front End:	Convex Condenser Lens
Detector Type:	Pulse Width Discriminator
Receiver Bandwidth:	30 Mhz
Spectral Response:	800 - 1100 nm
Alert Hold Time:	3 seconds

### Radar Detector

Receiver Type:	Double Conversion Superheterodyne Self-Contained Antenna
Detector Type:	Scanning Frequency Discriminator
Antenna Type:	Linear polarized, E vector vertical
Sensitivity:	X band = -114 dBm/cm <sup>2</sup> K band = -104 dBm/cm <sup>2</sup> Ka SuperWideband = -10 dBm/cm <sup>2</sup>
Frequency of Operation:	10.490 - 10.560 GHz (X band) 24.040 - 24.260 GHz (K band) 33.40 - 36.00 Ghz (KaSuperWideband)

*Specifications subject to change without notice.*

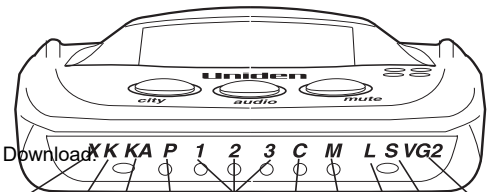
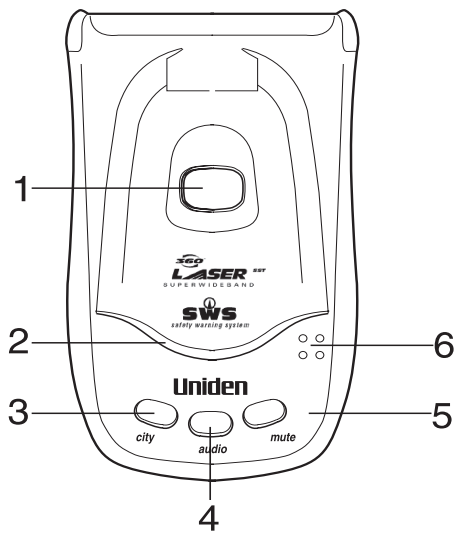
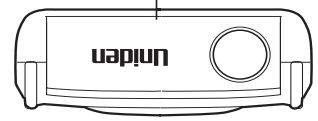
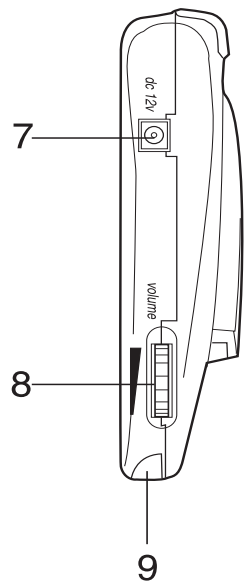

## Free Manuals Download Website

<http://myh66.com>

<http://usermanuals.us>

<http://www.somanuals.com>

<http://www.4manuals.cc>

<http://www.manual-lib.com>

<http://www.404manual.com>

<http://www.luxmanual.com>

<http://aubethermostatmanual.com>

Golf course search by state

<http://golfingnear.com>

Email search by domain

<http://emailbydomain.com>

Auto manuals search

<http://auto.somanuals.com>

TV manuals search

<http://tv.somanuals.com>