

**Uniden®**

# User's Guide



## **Model 1380 Speakerphone Telephone with Digital Answerer and Caller ID on Call Waiting**

# Important Information

---

**NOTICE:** This product meets the applicable Industry Canada technical specifications.

Operation is subject to the following two conditions: (1) This device may not cause interference, and (2) This device must accept any interference, including interference that may cause undesired operation of the device.

The equipment must be installed using an acceptable method of connection. The customer should be aware that compliance with the above conditions may not prevent degradation of service in some situations.

Repairs to certified equipment should be made by an authorized Canadian maintenance facility designated by the supplier. Any repairs or alterations made by the user to this equipment, or equipment malfunctions, may give the telecommunications company cause to request the user to disconnect the equipment.

Users should ensure for their own protection that the electrical ground connections of the power utility, telephone lines and internal metallic water pipe systems, if present, are connected together. This precaution may be particularly important in rural areas.

**CAUTION:** Users should not attempt to make such connections themselves, but should contact the appropriate electric inspection authority, or electrician, as appropriate.

NOTES: This equipment may not be used on coin service provided by the telephone company.

# Interference Information

---

This equipment generates and uses radio frequency energy which may interfere with residential radio and television reception if not properly installed and used in accordance with instructions contained in this manual. Reasonable protection against such interference is ensured, although there is no guarantee this will not occur in a given installation. If interference is suspected and verified by switching this equipment on and off, the user is encouraged to try to correct the interference by one or more of the following measures: Reorient the radio/television receiver's antenna, relocate the equipment with respect to the receiver, plug the equipment and receiver into separate circuit outlets. The user may also wish to consult a qualified radio/television technician for additional suggestions. This equipment has been fully tested and complies with all limits for Class B computing devices pursuant to part 15 FCC Rules and Regulations.

# Telephone Network Information

---

Should your equipment cause trouble on your line which may harm the telephone network, the telephone company, where practicable, may notify you that temporary discontinuance of service may be required. Where prior notice is not practicable and the circumstances warrant such action, the telephone company may temporarily discontinue service immediately.

The telephone company may make changes in its communications facilities, equipment, operations or procedures where such action is required in the operation of its business. If these changes are expected to affect the use or performance of your telephone equipment, the telephone company will

likely give you adequate notice to allow you to maintain uninterrupted service.

Notice must be given to the telephone company upon termination of your telephone from your line.

## **REN Number**

---

On the bottom of this equipment is a label indicating, among other information, the Ringer Equivalence Number (REN) for the equipment.

The REN is useful in determining the number of devices you may connect to your telephone line and still have all of these devices ring when your telephone number is called. In most (but not all) areas, the sum of the RENs of all devices connected to one line should not exceed 5. To be certain of the number of devices you may connect to your line as determined by the REN, you should contact your local telephone company.

**REN Number is located on the cabinet bottom.**

## **Hearing Aid Compatibility**

---

This telephone system meets FCC standards for Hearing Aid Compatibility.

## **Licensing**

---

Licensed under US Patent 6,427,009.

## **FCC RF Radiation Exposure Statement**

---

This equipment complies with FCC RF radiation exposure limits set forth for an uncontrolled environment. This equipment should be installed and operated with a minimum distance of 20 centimeters between the radiator and your body. This transmitter must not be co-located or operated in conjunction with any other antenna or transmitter.

# Table of Contents

<b>Important Information</b> .....	2	Receiving a Phone Call	13
<b>Interference Information</b> .....	2	Placing a Phone Call	13
<b>Telephone Network Information</b> ..	2	Switching between Speaker and Handset	13
<b>REN Number</b> .....	3	Temporary Tone Dialing	13
<b>Hearing Aid Compatibility</b> .....	3	Flash	14
<b>Licensing</b> .....	3	Redial	14
<b>FCC RF Radiation Exposure Statement</b> .....	3	Mute	14
<b>Introduction</b> .....	6	<b>Telephone Set Up</b> .....	15
<b>Before You Begin</b> .....	6	Setting the Rings to Answer	15
Parts Checklist	6	Setting the Incoming Message or Memo Length	16
Telephone Jack Requirements	6	Setting the Recording Quality	16
<b>Important Installation Information</b> .....	7	Setting the Security Code	17
<b>Base Layout</b> .....	8	Setting the Display Contrast	17
<b>Installing the Phone</b> .....	9	Setting Your Local Area Code	18
Desktop Installation	9	Setting the Dialing Mode	18
Wall Mounting the Phone	10	Setting Day of Week	18
Important Instructions for Moving the Answerer	11	Setting the Time and Date	19
<b>Answering System Setup</b> .....	11	Setting the Language	20
Recording the Outgoing Announcement	11	Message Volume	20
Reviewing the Announcement	12	Ringer Volume	20
<b>Telephone Operation</b> .....	12	Speakerphone Volume	21
Using the Speakerphone	12	<b>Caller ID Features</b> .....	22
Speakerphone Location	12	Summary Screen	22
Speakerphone Use	12	Caller ID with Call Waiting	23
		Receiving and Storing Calls	23
		Reviewing Call Records	23
		Deleting CID Records	24
		Dialing Back	24

# Table of Contents

If You Programmed Your Local Area Code ..... 24

If You Did Not Program Your Local Area Code ..... 25

**Memory ..... 26**

    Storing a Number in Memory ..... 26

    Storing a Redial Number to Memory 27

    Erasing a Stored Number..... 28

    Copying Caller ID Memories to User Memory ..... 28

    Inserting a Pause in the Dialing Sequence ..... 29

    Changing a Stored Number ..... 29

    Dialing a Number Stored in Memory While On-hook..... 29

    Dialing a Number Stored in Memory 29

    Reviewing Stored Numbers ..... 30

    Chain Dialing from Memory..... 31

**Answering System Operation ...32**

    Call Answering ..... 32

    Auto Disconnect ..... 32

    Playing Messages ..... 33

    Erase Messages ..... 33

    Leaving a Memo..... 34

    Memory Full ..... 34

    Remote Access ..... 34

        Remote Access Commands ..... 35

**Message Indicators ..... 36**

**Troubleshooting Guide ..... 37**



**General Product Care..... 39**

**Causes of Poor Reception..... 40**

**Warranty ..... 41**

**Index ..... 42**

**WARNING: TO PREVENT FIRE OR ELECTRICAL SHOCK HAZARD, DO NOT EXPOSE THIS PRODUCT TO RAIN OR MOISTURE.**

 <p>THE LIGHTNING FLASH AND ARROW HEAD WITHIN THE TRIANGLE IS A WARNING SIGN ALERTING YOU OF "DANGEROUS VOLTAGE" INSIDE THE PRODUCT.</p>	<p><b>CAUTION:</b> RISK OF ELECTRICAL SHOCK DO NOT OPEN</p> <p>CAUTION: TO REDUCE THE RISK OF ELECTRIC SHOCK, DO NOT REMOVE COVER (OR BACK). NO USER SERVICEABLE PARTS INSIDE. REFER SERVICING TO QUALIFIED SERVICE PERSONNEL.</p>	 <p>THE EXCLAMATION POINT WITHIN THE TRIANGLE IS A WARNING SIGN ALERTING YOU OF IMPORTANT INSTRUCTIONS ACCOMPANYING THE PRODUCT.</p>
<p>SEE MARKING ON BOTTOM / BACK OF PRODUCT</p>		

# Introduction

**CAUTION:** When using telephone equipment, there are basic safety instructions that should always be followed. Refer to the **IMPORTANT SAFETY INSTRUCTIONS** provided with this product and save them for future reference.

## Before You Begin

### Parts Checklist

Make sure your package includes the following items:



Base



DC power adaptor



Handset

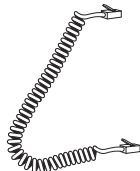

Coiled cord

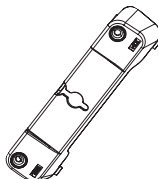

Mounting bracket



Line cord

Wall plate

### Telephone Jack Requirements

To use this phone, you need an RJ11C type modular telephone jack, which might look like the one pictured here, installed in your home. If you don't have a modular jack, call your local phone company to find out how to get one installed.

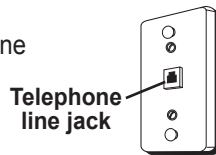



## Important Installation Information

- Never install telephone wiring during a lightning storm.
- Never touch non-insulated telephone wires or terminals, unless the telephone line has been disconnected at the network interface.
- Use caution when installing or modifying telephone lines.
- Never install telephone jacks in wet locations unless the jack is specifically designed for wet locations.

# Base Layout

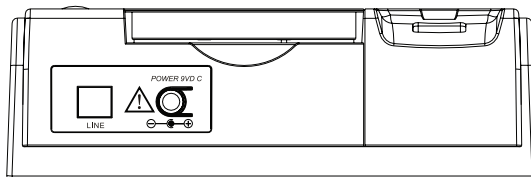
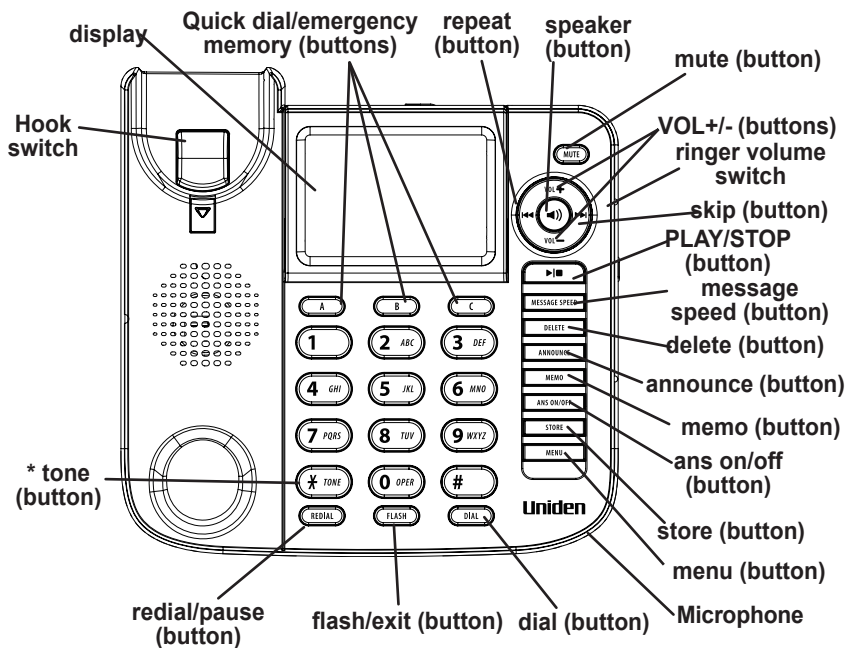



# Installing the Phone

## Desktop Installation

**CAUTION:** To reduce risk of personal injury, fire, or damage use only the 5-2784 power adaptor listed in the user's guide. This power adaptor is intended to be correctly orientated in a vertical or floor mount position.

1. Plug the coiled cord into the handset. Plug the other end into the jack on the side of the base.
2. Place the handset in the base.
3. Plug the telephone line cord into the LINE jack on the back of the phone. Plug the other end into a wall jack.
4. Connect the small end of the power adaptor into the POWER 9V DC jack on the back of the answerer. Plug the other end into an AC power outlet. The unit announces "**Press menu key to set up the unit**". The unit is ready for setup or to answer calls with the default greeting and settings.



**Note:** The phone automatically defaults to touch-tone dialing. To change to pulse (rotary) dialing, see "Setting the Dialing Mode." If you don't know which type of service you have, check with the phone company.

**Note:** The unit is properly installed if you pick up the handset and hear the dial tone. Otherwise, recheck all the installation steps.

## Wall Mounting the Phone

Your speakerphone can also be mounted on a wall plate (not included).

**Note: To prevent the handset from falling out of the cradle while the phone is hanging on the wall, you must switch both the handset hook and the desk stand to their wall-mount positions.**

1. On the front of the base, pull the handset hook out of the slot. Rotate hook 180 degrees and flip it from front to back. Slide it back into the slot.
2. Turn the base over. Press in on the tabs and remove the desk stand from the back of the base.
3. Rotate the stand 180 degrees, and insert the hooks marked WALL into the notches marked WALL. Press in on the tabs and snap the stand into place.
4. Connect the telephone line cord to the wall jack and the phone. If desired, wrap any excess cord around the cord hooks as shown.
5. Place the mounting slots over the pins on the wall plate, and slide the base down to lock it into place.

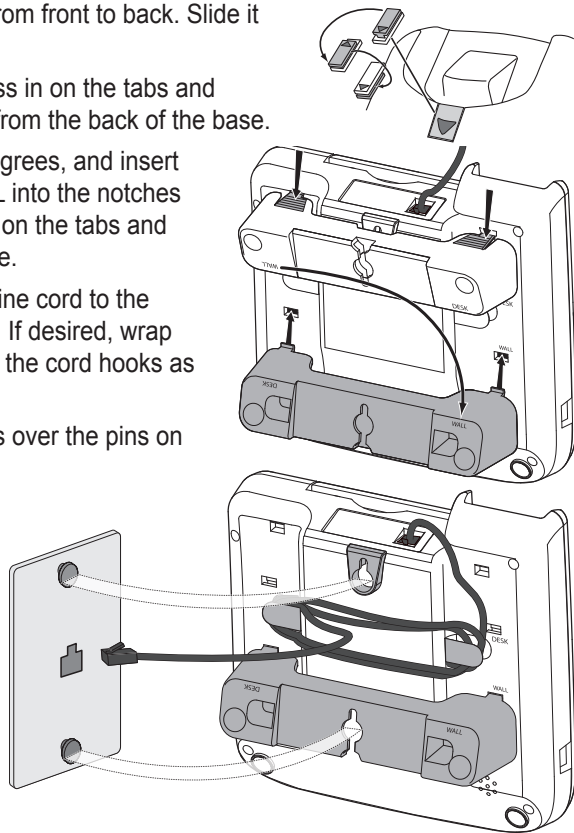

## Important Instructions for Moving the

## Answerer:

To move the answerer to a different location in the house, follow these instructions:

1. Disconnect the phone line.
2. Go to the electrical outlet and unplug the power adaptor.
3. Move the unit and phone line to the desired location.
4. Plug in the power adaptor into an electrical outlet.
5. The display shows that the messages have not been erased.
6. Connect the phone line.
7. Reset the time/date settings or wait for the next call to set them automatically.

## Answering System Setup

### Recording the Outgoing Announcement

Before using your new answerer, you should record a greeting (the announcement callers hear when your answering system answers a call). If you don't record a greeting, callers hear a default greeting which says, "**We are not available to take your call. Please leave a message. Thank you for calling.**"

When recording the greeting you should be about 6 inches from the unit. Eliminate as much background noise as possible.

1. Prepare your greeting.  
**Sample Greeting:** *"Hi, this is (use your name here). I can't answer the phone right now, so please leave your name, number, and a brief message after the tone, and I'll get back to you. Thanks for calling."*
2. Hold down the **ANNOUNCE** button. The unit announces "**Record announcement after the tone,**" and the screen displays **TO RECORD**. After the tone, you can record a 1 minute greeting (OGA) on the unit.
3. Release **ANNOUNCE** when you finish.
  - To review the greeting, press and release **ANNOUNCE**. The unit plays back your greeting automatically.

- To return to the answerer's default greeting after you've recorded one, press **ANNOUNCE** and release it when you hear the tone, or press and hold **DELETE** when the greeting is playing.

## Reviewing the Announcement

Press and release the **ANNOUNCE** button to review your outgoing announcement.

## Telephone Operation

---

### Using the Speakerphone

#### Speakerphone Location

For best speakerphone performance, avoid the following:

- Areas with high background noise. (The microphone might pick up these sounds and prevent the speakerphone from going into the receiving mode when you finish talking.)
- Surfaces affected by vibration.
- Recessed areas such as in a corner, under a cupboard, or next to a cabinet, which can generate an echo effect.

#### Speakerphone Use

Note the following guidelines when using the speakerphone:

- The speakerphone works similar to a two-way radio in that you can only listen or talk at one time.
- Stay reasonably close to the phone so that you can be clearly heard by the person to whom you are talking.
- You can adjust the speaker volume by pressing the **VOL (+ or -)** buttons.
- The speakerphone indicator comes on when the speakerphone is in use.

## Receiving a Phone Call

1. When the phone rings, the speakerphone indicator blinks and the caller's information, if any, will be shown on the display panel. Lift the handset or press the **SPEAKER** button to connect your phone call.
2. You can adjust the volume of the caller's voice by pressing the **VOL (+ or -)** buttons.

## Placing a Phone Call

1. Lift the handset or press the **SPEAKER** button and wait for a dial tone.
2. Dial the telephone number you wish to call.
3. User can also dial the number on the keypad first, then press the **SPEAKER** button to dial out. In case of a mistake in entering the number, press **DELETE** to erase the last digit.
4. You can adjust the volume of the caller's voice by pressing the **VOL (+ or -)** buttons.

## Switching between Speaker and Handset

You can switch between speakerphone and handset while the phone is dialing a number, or anytime during a conversation.

- **Speaker to Handset** — Pick up the handset.
- **Handset to Speaker** — Press **SPEAKER**, then hang up handset.

## Temporary Tone Dialing

If you have pulse service, you can temporarily change from pulse to tone service. After dialing the telephone number, press and release the **TONE (\*)** button on the telephone. This allows access to phone services that require a tone, such as banking and long-distance services. After you hang up the handset, the telephone automatically returns to pulse service.



## Flash

Press the **FLASH** button instead of using the hook switch to activate customer calling services such as call waiting or call transfer, which are provided by your local phone company.

## Redial

Redial the last number you called by pressing the **REDIAL** button after you get a dial tone.

**Note: The REDIAL feature holds in memory the last phone number you dialed (as many as 32 digits). If you pressed any numbers after dialing the phone number, (for example, when accessing a voice-menu system) those numbers also are redialed.**

**IMPORTANT: In the event of a power outage, your phone will still be able to make and receive calls, however, the speakerphone and answerer will not be operational.**



## Mute

1. Press the **MUTE** button to mute a call, the **MUTE** indicator will light up. You will still be able to hear the calling party but they will not be able to hear you speaking.
2. Press the **MUTE** button again to unmute the call.

# Telephone Set Up

You can customize the following settings to suit your needs.

- Rings to Answer** Selects the number of rings before the unit answers.
- Message Length** Sets the length of time allowed for incoming messages.
- Recording Quality** Sets the recording quality between standard (STD) and long play (LONG).
- Remote Access** Set your 3-digit code used for remote access to the unit.
- Display Contrast** Selects the display contrast.
- Local Area Code** Sets your local area code for Dial Back.
- Tone/pulse Dialing** Sets the phone for tone or pulse dialing.
- Set Day** Sets the day.
- Time/Date** Sets the time and date.
- Language** Selects English, French or Spanish.

Default Settings	
Rings to Answer	4
Message Length	2 minute
Recording Quality	Standard
Security Code	1 2 3
Display Contrast	3
Local Area Code	---
Dialing	Tone
Day	Sunday
Time/Date	12 a.m. 1/01
Language	English

## Setting the Rings to Answer

This setting allows you to set the number of rings before the unit answers a call. You can choose from 2-8 or Toll Saver (see "Toll Saver.")

1. Press and release the **MENU** button. The screen displays **RING TO ANSWER**. The unit announces, **Setup Menu**. Use **SKIP** to change setting. Press **MENU** to save a setting.
2. Use **SKIP** or **REPEAT** for the desired setting (2-8, Toll Saver).
3. When finished, press **MENU** to confirm.

**Note:** To skip to the next setting, press **MENU**. To exit setup, press **EXIT**.

## Toll Saver

Toll Saver can save you the cost of a call when you access your messages from another phone:

- If you have new messages, the unit answers after the 3rd ring.
- If you have no new messages, the unit answers after the 5th ring.

You can hang up after the 3rd ring and save the pay telephone or long distance charge.

## Setting the Incoming Message or Memo Length

This setting allows you to set the maximum length of time allowed for a single incoming message or memo. You can choose from 1 minute to 4 minutes.

1. Press and release the **MENU** button until the screen displays **MESSAGE LENGTH**.
2. Use **SKIP** or **REPEAT** for the desired setting.
3. When finished, press **MENU** to confirm.

**Note: To skip to the next setting, press MENU. To exit setup, press EXIT.**

## Setting the Recording Quality

This setting allows you to set the recording quality between standard (STD) and long play (LONG). Long play will give more recording time than standard.

1. Press and release the **MENU** button until the screen displays **REC: ▶ STD LONG**.
2. Use **SKIP** or **REPEAT** or select the desired setting.
3. Press **MENU** to confirm setting and go to next setting.



## Setting the Security Code

This feature allows you to change the factory default remote access code used for remote access to your answerer. The default code is 123.

1. Press and release the **MENU** button until the screen displays **REMOTE ACCESS**.
2. The left-most digit, or a ( \_ ) sign flashes indicating the unit is ready to accept the security code entry.
3. Use the keypad number to set the 3-digit security code in one step.
4. After the 3rd and last digit is entered, press the **MENU** button to store the security code and go to the next setting.

**Note: To skip to the next setting, press MENU. To exit setup, press EXIT.**

**Note: If you make a mistake, you can use SKIP or REPEAT to move between 1st to 3rd digit and input number from keypad again.**

## Setting the Display Contrast

This setting allows you to adjust the display contrast for easier readability.

1. Press and release the **MENU** button until the screen displays **CONTRAST**.
2. Use **SKIP** or **REPEAT** to select the desired setting (1-5).
3. When finished, press **MENU** to confirm and go to the next setting.

**Note: To skip to the next setting, press MENU. To exit setup, press EXIT.**

## Setting Your Local Area Code

1. Press and release the **MENU** button until the screen displays **LOCAL AREA CODE**.
2. The left-most digit, or a ( ) sign flashes indicating the unit is ready to accept the area code entry.
3. Press the keypad number to set the 3-digit local area code in one step.
4. After the 3rd and last digit are entered, press the **MENU** button to store the area code and go to the next setting.

**Note: If you make a mistake, you can use SKIP or REPEAT to move between 1st to 3rd digit and input the number from the keypad again.**

**Note: To skip to the next setting, press MENU. To exit setup, press EXIT.**

## Setting the Dialing Mode

This adjustment allows you to select tone (touch-tone) or pulse (rotary) mode dialing. The phone is automatically set for touch-tone use.

1. Press and release the **MENU** button until the screen displays **▶ TONE PULSE**. “▶” indicates which set up the unit is currently in.
2. Use **SKIP** or **REPEAT** for the desired setting.
3. When finished, press **MENU** to confirm.

**Note: To skip to the next setting, press MENU. To exit setup, press EXIT.**

## Setting Day of Week

This setting allows you to set day of week .

1. Press and release the **MENU** button until the screen displays **SET DAY**.
2. Use **SKIP** and **REPEAT** for the desired setting .
3. Press **MENU** to confirm and go to the next setting.

## Setting the Time and Date

**Note:** If you have subscribed to the Caller ID display feature from your telephone company, the telephone company sends the time and date with the Caller ID information. The unit automatically sets the time and date when the first call is received.

### Hour

1. Press and release the **MENU** button until the screen displays **SET TIME/DATE**.
2. The hour digits flashing indicates that the unit is ready to accept entry. Use the keypad numbers to enter a two digit number to set the hour.
3. When finished, the cursor moves to the Minute field. Now you're ready to enter the minutes.

### Minutes

1. Use the keypad numbers to enter a two digit number to set the minutes.
2. When finished, the cursor moves to the **AM** or **PM** field. Now you're ready to enter the time of day, **AM** or **PM**.

### AM/PM

1. Press "\*" on the keypad for **AM** and press "#" for **PM** to set the time of day.
2. When finished, the cursor moves to the Month field. Now you're ready to enter the month.

### Month

1. Use the keypad to enter two digit numbers to set the month.
2. When finished, the cursor moves to the Date field. Now you're ready to enter the day.

## Date

1. Use the keypad to enter two digit numbers to set the date.
2. When finished, press **MENU** to confirm.

**TIP: For example, to enter 8:09 a.m. 7/4:**

1. Press 08.
2. Press 09.
3. Press \* (for a.m.).
4. Press 07.
5. Press 04.
6. Press **MENU**.

**Note: To skip to next setting, press SKIP. To exit setup, press EXIT.**

## Setting the Language

This setting allows you to listen to voice prompts and view Caller ID prompt messages in English, French or Spanish.

1. Press and release the **MENU** button until the screen displays **> ENG FRA ESP**.

“>” indicates which set up the unit is currently in.

2. Use **SKIP** or **REPEAT** for the desired setting.
3. When finished, press **MENU** to confirm.

**Note: To skip to the next setting press MENU. To exit setup, press EXIT.**

## Message Volume

Use the **VOL** (+ or -) buttons to adjust the volume when playing back messages and while reviewing or changing the setting.

## Ringer Volume

Use the switch at the side of the unit to adjust the loudness of the ringer.



## Handset Volume

Use the **VOL** (+ or -) buttons to adjust the handset listening volume while it is in use.



## Speakerphone Volume

Use the **VOL** (+ or -) buttons to adjust the speakerphone listening volume while it is in use.



# Caller ID Features

**IMPORTANT:** In order to use this unit's Caller ID features, you must subscribe to either the standard Name/Number Caller ID Service or Call Waiting Caller ID Service. To know who is calling while you are on the phone, you must subscribe to Call Waiting Caller ID Service.

This unit receives and displays CID information transmitted by your local telephone company. This information can include the phone number, date and time; or the name, phone number, and date and time.

## Summary Screen

The summary screen shows the current time, current date and number of new calls to be reviewed. It is displayed until any button is pressed. Within 10 seconds of receiving a new call, the summary screen is displayed.

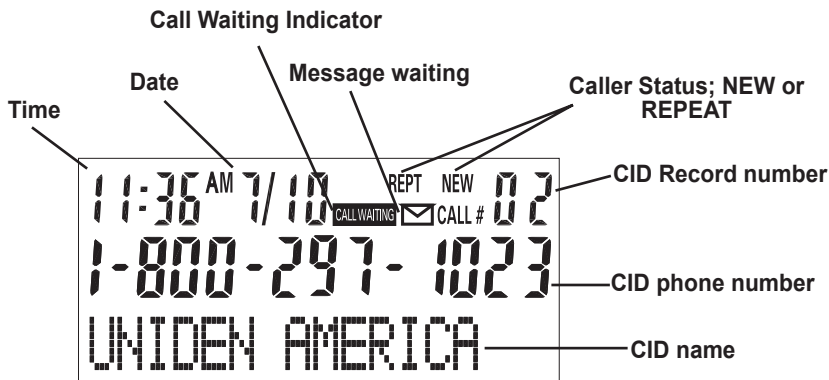

## Caller ID with Call Waiting

Provided you subscribe to Call Waiting Caller ID service from your phone company; if you receive an incoming call and you are already on the phone, a beep indicates the presence of a Call Waiting call on the line. Only the handset that is in use at the time of the call will display and store the Call Waiting Caller ID information.

- When you hear the call waiting beep in the handset receiver, press the **FLASH/EXIT** button to put the current call on hold and answer the incoming call. Press **FLASH/EXIT** again to return to the original call.

## Receiving and Storing Calls

The unit receives and displays information transmitted by your local phone company. This information can include the phone number, date, and time; or the name, phone number, date, and time. The unit can store up to 60 CID memories for later review. When the Caller ID memory is full, a new call automatically replaces the oldest call in memory. **NEW** appears in the display for calls received that have not been reviewed. **REPT** appears in the display for calls received more than once which have not been reviewed.

## Reviewing Call Records

Use either the **SKIP** or **REPEAT** button to review your Caller ID records.

- Press **REPEAT** to scroll through the call records from the most recent to the oldest.
- Press **SKIP** to scroll through the call records from the oldest to the newest.
- When all of the messages have been viewed, the screen displays **START/END**.
- If there are new calls, they will be displayed first.
- If there are only old calls, all the calls will be reviewed.

## Deleting CID Records

- To delete the record shown in the display, press the **DELETE** button once.
- To delete all records while reviewing, press and hold the **DELETE** button for about three seconds. The screen displays **DELETE ALL?**. Press **DELETE** again to complete.

## Dialing Back

When reviewing Caller ID records, you can dial back the numbers on the display by pressing the dial button.

**Note:** If **PICKUP PHONE** shows in the display, no other changes to the number can be made. The information sent from the telephone company is known to be a valid number for dialing back (used only in very limited areas). Once you pickup the phone, the number is automatically dialed.

## If You Programmed Your Local Area Code

1. Use the **SKIP** or **REPEAT** buttons to display the number you want to dial.
  2. Press the **DIAL** button.
- If you see a number with seven digits (i.e. 555-1234), then the call is from within your area code. However, this does not guarantee the call is a local call.
  - If you see a number with 11 digits (i.e. 1-234-555-1234), then the call is not from within your area code.

**Note:** A timer (10 seconds on-hook and 3 seconds off-hook) located in the upper right side of the display will start, letting you know how much time is left until the unit returns to the Summary Screen.



- 
3. If you are at on-hook and **PICKUP** or **ADJ** displays, you can adjust the phone number format by pressing the **DIAL** button. If the phone is off-hook and **ADJUST** shows in the display, you can adjust the phone number format by pressing the **DIAL** button. For example, sometimes a 7-digit local number cannot be dialed because it requires a 10-digit or 11-digit format. Press the **DIAL** button repeatedly to scroll through the 7, 10, and 11-digit numbers.

**7-digits:** 7-digit telephone number (i.e. 555-5555)

**10-digits:** 3-digit area code + 7-digit telephone number (i.e. 425-555-5555)

**11-digits:** long distance code 1 + 3-digit area code + 7-digit telephone number (i.e. 1-425-555-5555)

4. To dial the displayed number, and the phone is on-hook, pick up the handset or press the **SPEAKER** button before the timer reaches 0. If the phone is off-hook, wait until the time reaches 0. The screen displays **NOW DIALING** and the number is dialed.

## If You Did Not Program Your Local Area Code

1. Use the **SKIP** or **REPEAT** buttons to display the number you want to dial. You will only see 10-digit numbers (i.e. 234- 555-1234).
2. See Steps 2 through 4 in the previous section to complete the dialback process.

# Memory

---

You may store up to 13 numbers in memory for quick dialing – 3 in the Quick Dial buttons (A, B, and C) and 10 in the keypad numbers (0-9). Each memory location can store number up to 32 digits.

## Storing a Number in Memory

1. Press the **STORE** button. The screen displays **LOCATION?**.
2. Press the desired memory location (0-9, A, B, C).

**Note: You may select memory locations by pressing SKIP or REPEAT (< or >) to scroll through the memory locations or press the 0 - 9, A, B, C.**

3. Press the **STORE** button again to confirm the memory location.

**Note: If necessary, to erase existing memories, or if you make a mistake, use the DELETE button.**

4. Use the number keys to enter the telephone number (up to 32 digits) and press the **STORE** button to save. (The unit will not dial a phone number in this mode.) The cursor automatically moves to the text line for name entry.
5. Use the number keys to enter the name of the person associated with the telephone number you just entered (up to 12 characters). More than one letter is stored in each of the number keys. For example, to enter the name BILL SMITH, press the “2” key twice for the letter B. Press the “4” key 3 times for the letter I. Press the “5” key 3 times for the letter L.

**Note: The flashing cursor automatically moves to the next position or you may press the SKIP or REPEAT buttons to move the cursor to the next position.**

Press the “5” key 3 times for the second letter L. Press the **SKIP** button to insert a space, and press the “7” key 4 times for the letter S. Press the “6” key once for the letter M. Press the “4” key 3 times for the letter I. Press the “8” key for the letter T. Press the “4” key twice for the letter H.

7. To enter another name and number in a different memory location, return to Step 1 and repeat the process.

## Storing a Redial Number to Memory

1. Press the **REDIAL** button and the screen displays the number.
2. Press the **STORE** button. The screen displays **LOCATION?**.
3. Press the desired memory location (0-9, A, B , C ).
4. Press the **STORE** button again to confirm the memory location.
5. Press the **STORE** button again to save and you may now enter the contact name.
6. Use the number keys to enter the name of the person associated with the telephone number you just entered. More than one letter is stored in each of the number keys. For example, to enter the name BILL SMITH, press the “2” key twice for the letter B. Press the “4” key 3 times for the letter I. Press the “5” key 3 times for the letter L.

**Note: The flashing cursor automatically moves to the next position or you may press the REPEAT or SKIP buttons to move the cursor to the next position.**

7. Press the “5” key 3 times for the second letter L. Press the **SKIP** to insert a space. And press the “7” key 4 times for the letter S. Press the “6” key once for the letter M. Press the “4” key 3 times for the letter I. Press the “8” key for the letter T. Press the “4” key twice for the letter H.
8. Press the **STORE** button to confirm.

## Erasing a Stored Number

1. Press the **STORE** button.
2. Press the memory location (0-9, A, B, C) to be erased.
3. Press the **DELETE** button.

## Copying Caller ID Memories to User Memory

1. Press the **SKIP** or **REPEAT** buttons to view the caller number and name you want to copy.
2. Press the **DIAL** button to change the format (11 or 10 or 7 digits number format) as desired.
3. Press the **STORE** button.
4. Press the memory location (0-9, A, B, C). The number flashes if there is a number already stored in the memory location.
5. Press the **STORE** button to enter the edit mode, and then press the **STORE** button again to edit the name.

**Note: You may select a different memory location by pressing the SKIP or REPEAT button to scroll through the memories or press a number key (0-9, A, B, C).**

6. Press the **STORE** button to confirm and save.

**Note: If the name you want to enter is longer than 12 characters, only the first 12 characters will be copied into memory.**

## Inserting a Pause in the Dialing Sequence

Press the **REDIAL/PAUSE** button to insert a delay in the dialing sequence of a stored telephone number when a pause is needed to wait for a dial tone (for example after you dial 9 for an outside line, or to wait for a computer access tone). Each pause is represented as “**P**” on the display and counts as 1 digit in the dialing sequence.

## Changing a Stored Number

Repeat the storage sequence under “Storing A Name and Number in Memory”, and use the **DELETE** button to delete the old number before entering the new number.

## Dialing a Number Stored in Memory While On-hook

1. Press the **DIAL** button.
2. To select a memory, press any number key (0-9, A, B, C). The number in that memory location displays.

**Note: You may select a different memory location by pressing the SKIP or REPEAT button to scroll through the memories or press a number key (0-9, A, B, C).**

3. Press the **SPEAKER** button, or pick up the handset to dial the displayed number.

## Dialing a Number Stored in Memory

1. Lift the handset, or press the **SPEAKER** button.
2. Press the **DIAL** button then press a memory location button.

## Reviewing Stored Numbers

1. Press **DIAL**. The screen displays **LOCATION?**
2. Press a memory location key (0-9, A, B , C ) to review the memory location's content.
  - To dial the displayed number, press the **SPEAKER** button or lift the handset.
  - To exit stored number review, press **FLASH/EXIT**.
  - To change the displayed number, press **STORE**.
  - Use the number keys to enter the telephone number (up to 32 digits ) and press the **STORE** button to save. (The unit will not dial a phone number in this model.) The cursor automatically moves to the text line for name entry.
  - Use the number keys to enter the name of the person associated with the telephone number you just entered. More than one letter is stored in each of the number keys. For example, to enter the name BILL SMITH, press the “2” key twice for the letter B. Press the “4” key 3 times for the letter I. Press the “5” key 3 times for the letter L.

**Note: The flashing cursor automatically moves to the next position or you may press the SKIP or REPEAT buttons to move the cursor to the next position.**

- Press the “5 “ key 3 times for the second letter L. Press the arrow key (4) two times to insert a space. Press the “7 “ key “4” times for the letter S. Press the “8” key for the letter T. Press the “4” key twice for the letter H.

## Chain Dialing from Memory

Use this feature to make calls which require a sequence of numbers, for instance, if you use a calling card for a frequently called long distance number. Basically, you dial each part of the sequence from memory. The following example shows how you can use chain dialing to make a call through a long distance service:

<i><b>The Number For</b></i>	<i><b>Memory Location</b></i>
Long distance access number	6
Authorization code (ID)	7
Long distance phone number	8

1. Pick up the handset or press **SPEAKER**.
2. Press **DIAL** button, then press number "6" for the memory location.
3. Press **DIAL** button, then press number "7" for the memory location.
4. Press **DIAL** button, then press number "8" for the memory location.
5. The number dials automatically.

# Answering System Operation

---

## Call Answering

When a call comes in, the unit will ring the number of times set, play the greeting, and record the incoming call.

You can:

- Answer the call before the unit answers.
- Pick up the phone during the greeting.
- Listen to the incoming message (Call screening).
- Pick up the phone during the incoming message, if desired.
- Disconnect the caller by pressing the **PLAY/STOP** button.

## Auto Disconnect

Auto disconnect is a feature that tells the unit to stop playing the greeting or recording when a extension phone is picked up. Sometimes you may pick up and the machine keeps playing the greeting. This is normal. If you want to pick up the phone during the greeting play, wait about two seconds after the system answers before picking up a phone.

If the greeting continues to play after picking up an extension phone, press the **PLAY/STOP** button.



## Playing Messages

Use the **PLAY/STOP** button to play messages. The unit first plays new messages in the order received. If there are no messages, the unit announces, **“You have no messages.”** If there are no new messages, the old messages are played back.

When playing messages, the message number and the date-time stamp will be shown on the display.

- To play messages, press and release **PLAY/STOP**.
- To stop playback, press and release **PLAY/STOP** again.
- To restart the message that is playing, press the **REPEAT** button once.
- To replay the previous message, press the **REPEAT** button twice.
- To play the **SKIP** message, press and release **SKIP**.

While playing message, user can press **MESSAGE SPEED** button to listen to message playback at a lower speed.

Each press of the **MESSAGE SPEED** button change message playback speed. The screen displays current message speed.

## Erase Messages

### Single Messages

You can erase a message itself, leaving the Caller ID information.

- While the message is playing, press and release **DELETE**. The unit erases the current message and announces, **“Message erased.”**

### All Messages

You can also erase all the old messages only, leaving the new messages and Caller ID information.

While the unit is in ready-to-answer mode, press and hold **DELETE** until the unit announces, **“Messages erased.”**

- New messages can not be erased in this way. To erase new messages, play them then press **DELETE** during play back.

## Leaving a Memo

Use the **MEMO** button to record a specific message for others who have access to the unit.

1. Press and hold the **MEMO** button. The unit announces, **“Record your memo after the tone.”**
2. Record your message after the beep.
3. Release **MEMO** when you’re finished talking. The unit treats the memo as a message, as the display shows.

## Memory Full

When the unit’s memory is full, it answers after 10 rings and announces, **“Memory is full.”** A 20-second waiting period follows, allowing you to enter your security code.

## Remote Access

You can access your answerer from any touch-tone phone from another location by entering your 3-digit security code (the default security code is 1 2 3, but you can change it.) Be aware that remote functions do not work with rotary or push-button pulse-dialing phones.

### To access your answerer:

1. Call your telephone number.
2. After you hear the beep that follows the greeting, enter your 3-digit security code. The unit confirms your code with a beep. To bypass the greeting, you can enter your 3-digit security code any time while the greeting is playing.

The unit waits for a remote command for 20 seconds after the correct security code has been entered. Menu selections can be made while the menu is playing.

**Note: The unit answers on the 10th ring when it is turned off or the memory is full. To access the answerer, enter the 3-digit security code after the beep. If memory is full, play messages and erase some of them to restore memory.**

**Note: After the unit plays the remote menu, it waits 20 seconds for a command, then disconnects.**

## **Remote Access Commands**

Play messages	2
Repeat messages (during message playback)	1
Skip to next message (during message playback)	3
Erase message (during message playback)	0
Stop playback(during message playback)	2
Turn answerer On/Off	4
Review menu again	7

## Message Indicators

---

The following special messages indicate the status of a message or the unit:

<b>00 CALLS</b>	The call record log is empty.
<b>UNKNOWN NUMBER</b>	The incoming call does not have Caller ID service or their service area is not linked to yours. If <b>UNKNOWN NAME</b> appears along with a calling number, the name information for that number was not available.
<b>BLOCKED NUMBER</b>	The caller is registered as "Private Number" and the Caller ID information is withheld.
<b>INCOMPLETE DATA</b>	Caller information has been interrupted during transmission.
<b>START/END</b>	Indicates you are at the beginning or the end of the call record log.
<b>MESSAGE</b>	The message has been recorded as a memo.

# Troubleshooting Guide

---

## Telephone Solutions

No dial tone

- Check the hook switch to make sure it pops up.
- 

Won't dial out

- Make sure the tone/pulse setting is programmed correctly.
- 

Phone doesn't ring

- Check the ringer volume.
  - Could have too many phones on one line.  
(See FCC registration information regarding REN)
- 

Low handset or speaker volume

- Check the volume settings.
- 

Can't be heard by other party

- Make sure the phone cord is securely plugged in.
  - Make sure the **MUTE** function is **OFF**.
- 

Memory dialing

- Make sure you entered the numbers correctly. (See "Memory.")
- 

## Answerer Solutions

Doesn't answer or answers on 10th ring

- Make sure the answerer is turned on.
  - Memory is full, erase some messages.
  - Check the AC power and phone line connections.
- 

Incoming messages are incomplete

- Was an extension phone picked up?
  - The caller left a message that is longer than the message length you set during setup.
  - Memory is full.
-

Won't respond to remote commands

- Must use a touch-tone phone.
  - Must enter the correct security code.
  - Did unit hang up? If you take no action for a period of time, it automatically hangs up.
- 

Answerer doesn't work

- Unplug the power cord from the electrical outlet and plug it back in to reset the answerer.
- 

After the unit is plugged in, the screen displays **FLASH ERROR**

- Unplug the unit and plug it back in. If the message appears again, the unit needs service.
- 

Can't hear messages

- Adjust the volume control.
- 

Greeting continues to play even after an extension phone is picked up.

- This is normal operation. Auto disconnect is delayed for 1 second after the unit answers a call. If you are near the unit, press **PLAY/STOP** to stop the greeting.
- 

No information is shown after the phone rings

- Be sure to wait until the second ring before answering.
  - Check all cabling to make sure that all connections are secure and not damaged.
  - Did you order Caller ID service from your local telephone company?
- 

Error message is displayed

- **ERROR** appears in the display if the unit detects anything other than valid Caller ID information during the silent period after the first ring. This message indicates either the presence of noise on the line, or that an invalid message has been sent from the telephone company?
-



## General Product Care

---

To keep your product working and looking good, follow these guidelines:

- Avoid putting it near heating appliances and devices that generate electrical noise (for example, motors or fluorescent lamps).
  - DO NOT expose to direct sunlight or moisture.
  - Avoid dropping product and/or other rough treatment.
  - Clean with a soft cloth.
  - Never use a strong cleaning agent or abrasive powder because this will damage the finish.
  - Retain the original packaging in case you need to ship it at a later date.
- 



## **Causes of Poor Reception**

---

- Aluminum siding.
- Foil backing on insulation.
- Heating ducts and other metal construction that can shield radio signals.
- You're too close to appliances such as microwaves, stoves, computers, etc.
- Atmospheric conditions, such as strong storms.
- Base is installed in the basement or lower floor of the house.
- Base is plugged into AC outlet with other electronic devices.
- Baby monitor is using the same frequency.
- Handset battery is low.
- You're out of range of the base.



# Warranty

Important: Evidence of original purchase is required for warranty service.

WARRANTOR: UNIDEN AMERICA CORPORATION ("Uniden")

ELEMENTS OF WARRANTY: Uniden warrants, for one year, to the original retail owner, this Uniden Product to be free from defects in materials and craftsmanship with only the limitations or exclusions set out below.

WARRANTY DURATION: This warranty to the original user shall terminate and be of no further effect 12 months after the date of original retail sale. The warranty is invalid if the Product is A) damaged or not maintained as reasonable or necessary, B) modified, altered, or used as part of any conversion kits, subassemblies, or any configurations not sold by Uniden, C) improperly installed, D) serviced or repaired by someone other than an authorized Uniden service center for a defect or malfunction covered by this warranty, E) used in any conjunction with equipment or parts or as part of any system not manufactured by Uniden, or F) installed or programmed by anyone other than as detailed by the owner's manual for this product.

STATEMENT OF REMEDY: In the event that the product does not conform to this warranty at any time while this warranty is in effect, warrantor will either, at its option, repair or replace the defective unit and return it to you without charge for parts, service, or any other cost (except shipping and handling) incurred by warrantor or its representatives in connection with the performance of this warranty. Warrantor, at its option, may replace the unit with a new or refurbished unit.

THE LIMITED WARRANTY SET FORTH ABOVE IS THE SOLE AND ENTIRE WARRANTY PERTAINING TO THE PRODUCT AND IS IN LIEU OF AND EXCLUDES ALL OTHER WARRANTIES OF ANY NATURE WHATSOEVER, WHETHER EXPRESS, IMPLIED OR ARISING BY OPERATION OF LAW, INCLUDING, BUT NOT LIMITED TO ANY IMPLIED WARRANTIES OF MERCHANTABILITY OR FITNESS FOR A PARTICULAR PURPOSE. THIS WARRANTY DOES NOT COVER OR PROVIDE FOR THE REIMBURSEMENT OR PAYMENT OF INCIDENTAL OR CONSEQUENTIAL DAMAGES. Some states do not allow this exclusion or limitation of incidental or consequential damages so the above limitation or exclusion may not apply to you.

LEGAL REMEDIES: This warranty gives you specific legal rights, and you may also have other rights which vary from state to state. This warranty is void outside the United States of America and Canada.

PROCEDURE FOR OBTAINING PERFORMANCE OF WARRANTY: If, after following the instructions in the owner's manual you are certain that the Product is defective, pack the Product carefully (preferably in its original packaging). Disconnect the battery (if any) from the Product and separately secure the battery in its own separate packaging within the shipping carton. The Product should include all parts and accessories originally packaged with the Product. Include evidence of original purchase and a note describing the defect that has caused you to return it. The Product should be shipped freight prepaid, by traceable means, to warrantor at:

Uniden America Service  
4700 Amon Carter Blvd.  
Fort Worth, TX 76155

# Index

## A

Answering System Operation .....	32
Answering System Setup .....	11
Auto Disconnect .....	32

## B

Base Layout.....	8
Before You Begin.....	6

## C

Call Answering.....	32
Caller ID Features .....	22
Caller ID with Call Waiting .....	23
Causes of Poor Reception.....	40
Chain Dialing from Memory.....	31
Changing a Stored Number.....	29
Copying Caller ID Memories to User Memory .....	28

## D

Deleting CID Records.....	24
Desktop Installation .....	9
Dialing a Number Stored in Memory .....	29
Dialing a Number Stored in Memory While On-hook .....	29
Dialing Back.....	24

## E

Erase Messages.....	33
Erasing a Stored Number .....	28

## F

FCC RF Radiation Exposure Statement.....	3
Flash .....	14

## G

General Product Care.....	39
---------------------------	----

## H

Hearing Aid Compatibility .....	3
---------------------------------	---

## I

If You Did Not Program Your Local Area Code .....	25
If You Programmed Your Local Area Code .....	24
Important Information .....	2
Important Installation Information .....	7
Important Instructions for Moving the Answerer .....	11
Inserting a Pause in the Dialing Sequence .....	29
Installing the Phone .....	9
Interference Information .....	2
Introduction.....	6

## L

Leaving a Memo .....	34
Licensing .....	3

## M

Memory.....	26
Memory Full.....	34
Message Indicators .....	36
Message Volume .....	20
Mute.....	14

# Index

<b>P</b>	
Parts Checklist.....	6
Placing a Phone Call.....	13
Playing Messages.....	33
<b>R</b>	
Receiving a Phone Call.....	13
Receiving and Storing Calls.....	23
Recording the Outgoing Announcement.....	11
Redial.....	14
Remote Access.....	34
Remote Access Commands.....	35
REN Number.....	3
Reviewing Call Records.....	23
Reviewing Stored Numbers.....	30
Reviewing the Announcement.....	12
Ringer Volume.....	20
<b>S</b>	
Setting Day of Week.....	18
Setting the Dialing Mode.....	18
Setting the Display Contrast.....	17
Setting the Incoming Message or Memo Length.....	16
Setting the Language.....	20
Setting the Recording Quality.....	16
Setting the Rings to Answer.....	15
Setting the Security Code.....	17
Setting the Time and Date.....	19
Setting Your Local Area Code.....	18
Speakerphone Location.....	12
Speakerphone Use.....	12
Speakerphone Volume.....	21
Storing a Number in Memory.....	26
Storing a Redial Number to Memory.....	27
Summary Screen.....	22
Switching between Speaker and Handset	13
<b>T</b>	
Telephone Jack Requirements.....	6
Telephone Network Information.....	2
Telephone Operation.....	12
Telephone Set Up.....	15
Temporary Tone Dialing.....	13
Troubleshooting Guide.....	37
<b>U</b>	
Using the Speakerphone.....	12
<b>W</b>	
Wall Mounting the Phone.....	10
Warranty.....	41



# Uniden<sup>®</sup>

---

*Need Help? Get answers 24/7 at our website: [www.uniden.com](http://www.uniden.com).*

---

**OR**

<b>If You...</b>	<b>Contact Uniden's...</b>	<b>Phone Number</b>
have a question or problem	Customer Care Line*	817-858-2929 or 800-297-1023
need a part or accessory	Parts Department*	800-554-3988
need special assistance due to a disability	Accessibility Help Line	800-874-9314 (voice or TTY)

\* During regular business hours, Central Standard Time.  
Visit our website for detailed business hours.

Model 1380  
Printed in China

© 2009 Uniden America Corp.  
Fort Worth, TX.

## Free Manuals Download Website

<http://myh66.com>

<http://usermanuals.us>

<http://www.somanuals.com>

<http://www.4manuals.cc>

<http://www.manual-lib.com>

<http://www.404manual.com>

<http://www.luxmanual.com>

<http://aubethermostatmanual.com>

Golf course search by state

<http://golfingnear.com>

Email search by domain

<http://emailbydomain.com>

Auto manuals search

<http://auto.somanuals.com>

TV manuals search

<http://tv.somanuals.com>