

Uniden®

QUICK EASY STEPS

for setting
up your
phone!

SEE YOUR
QUICK REFERENCE
GUIDE SECTION

BUY
ADDITIONAL
HANDSET
DCX640
(see back for details)



DCX646/646-2 SERIES

Download from www.Somanuals.com. All Manuals Search And Download.

OWNER'S MANUAL

Step 1 Checking the Package Contents

Make sure your cordless phone's packaging includes the following items (the number of items may vary depending on model number within the series).

If any of these items are missing or damaged, contact the Uniden Parts Department.

- Base Unit
- Handset(s)
- AC Adapter(s)
- Rechargeable Battery Pack(s)
- Telephone Cord
- Belt Clip(s)
- Owner's Manual
- Other Printed Materials

Uniden Parts Department at (800) 554-3988
Hours: M-F 8:00 a.m. to 5:00 p.m. CST.
or visit our website at
www.uniden.com for replacement parts.

Step 2 Install and Charge the Handset Battery

TO INSTALL THE HANDSET BATTERY

(see page 12 for details)

Charge the handset battery pack for at least 15-20 hours before using your new cordless telephone for the first time!

Use only the Uniden rechargeable battery pack supplied with your new phone.

A Remove the cover.

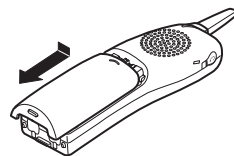

B Connect the battery pack connector with the correct polarity and listen for a click to insure connection.

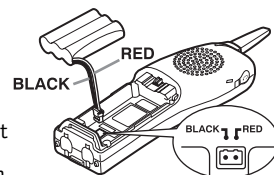

C Replace the cover.

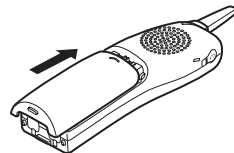

Use only the Uniden AC adapter supplied with your new phone.

D Plug the AC adapter cord into the base unit and then into a 120V AC outlet.

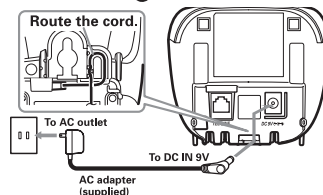

E Place the handset in the base and charge continuously for 15 - 20 hours before using the phone.

Step 3 Connect to Phone Line

When the handset battery pack is fully charged (after 15-20 hours of charging), plug the telephone cord into the base unit and then into a telephone wall jack.

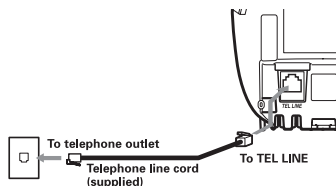

Your phone is set for tone dialing. If your local network requires pulse dialing, please see "D. Choose the dialing mode" on page 15.

Step 4 Setting Caller ID & Language Display Options

TO SET CALLER ID ON CALL WAITING AND CALL WAITING DELUXE

For all Handset Menu Setup options, refer to page 21.

- A** Press **menu/del** in standby mode.
- B** Press **ring/vol/∧** or **ring/vol/∨** to select **Global Setup** and then **select/☒**.

- C** Press **ring/vol/∧** or **ring/vol/∨** to select **CIDCW** and then **select/☒**.
- D** Press **ring/vol/∧** or **ring/vol/∨** to select **CW On/CWDX On**, **CW On/CWDX Off**, or **CW Off/CWDX Off** and then **select/☒**.

TO SET LANGUAGE

- A** Press **menu/del** in standby mode.
- B** Press **ring/vol/∧** or **ring/vol/∨** to select **Handset Setup** and then **select/☒**.
- C** Press **ring/vol/∧** or **ring/vol/∨** to select **Language** and then **select/☒**.
- D** Press **ring/vol/∨** to choose a language and then **select/☒**.

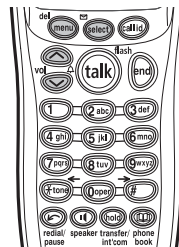

1° Paso Inspección del contenido del embalaje

Asegúrese de que haya recibido los siguientes artículos en el paquete (la cantidad de artículos puede variar dependiendo del número del modelo dentro de la serie). Si alguno de estos artículos falta o está dañado, comuníquese con el departamento de partes de Uniden.

- Base
- Receptor(es)
- Adaptador(es) CA
- Paquete(s) de pilas recargable(s)
- Cable telefónico
- Pinza(s) para la correa
- Manual para el usuario
- Otros impresos

Uniden Parts Department
Teléfono: (800)554-3988
Horas: de Lunes a Viernes desde las 8 a.m. hasta las 5:00 p.m., hora central
O visítenos en nuestra página Web en www.uniden.com para conseguir las partes de reemplazo.

2° Paso Instalación y carga de la pila para el receptor

Para instalar la pila del receptor

(Consulte la página 12 para más detalles)

Cargue el paquete de batería to pila por lo menos de 15 á 20 horas antes de conectarlo a una línea telefónica.

Use solamente el paquete de pilas recargable de Uniden suministrado con su nuevo teléfono.

A Quite la tapa.

Conecte el enchufe del paquete de las pilas con la polaridad correcta y escuche por un clic para asegurar la conexión.

C Reponga la tapa.

Use solamente el adaptador CA de Uniden suministrado con su nuevo teléfono.

D Conecte el cable del adaptador CA en la base y luego en una toma CA de 120 V.

Antes de usar el teléfono, coloque el receptor en la base y cárguelo continuamente por 15-20 horas.

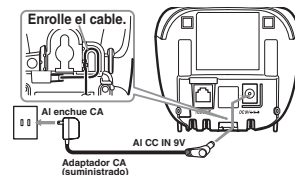
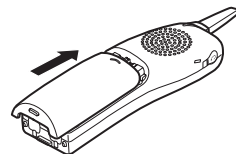
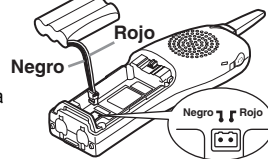
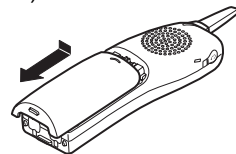

3° Paso Conexión a la línea telefónica

Cuando el paquete de pilas del receptor esté totalmente cargado, después de una carga de 15-20 horas, conecte el cable telefónico en la base y luego en el enchufe telefónico de la pared.

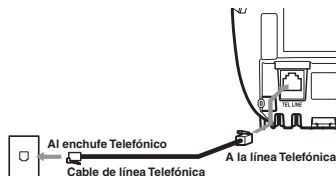

Su teléfono está programado para marcar por tono. Si su red local requiere la marcación por pulso, por favor consulte "D. Selección del modo de marcación" en la página 15.

4° Paso Programación de las opciones de identificación de llamadas y del lenguaje en la pantalla

Para programar las opciones de identificación de llamadas de llamadas en espera y llamada en espera de lujo

Para todas las demás opciones de programación en el menú, consulte la página 21.

A Oprima *menu/del* en el modo de espera.

B Oprima *ring/vol/∧* o *ring/vol/∨* para seleccionar la Progr global, y luego *select/☒*.

C Oprima *ring/vol/∧* o *ring/vol/∨* para seleccionar CIDCW, y luego *select/☒*.

D Oprima *ring/vol/∧* o *ring/vol/∨* para seleccionar CW Act/CWDX Act, CW Act/CWDX AP9, o CW AP9/CWDX AP9, y luego *select/☒*.

Para programar el lenguaje

A Oprima *menu/del* en el modo de espera.

B Oprima *ring/vol/∧* o *ring/vol/∨* para seleccionar la Progr receptor, y luego *select/☒*.

C Oprima *ring/vol/∧* o *ring/vol/∨* para seleccionar el Lenguaje, y luego *select/☒*.

D Oprima *ring/vol/∨* para escoger el lenguaje, y luego *select/☒*.

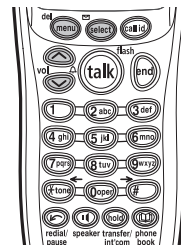

Contents

QUICK REFERENCE GUIDE	1	Chain Dialing	43
WELCOME/FEATURES/TERMINOLOGY	6	CALLER ID	44
CONTROLS AND FUNCTIONS	8	Caller ID and CIDCW (Caller ID on Call Waiting)	44
DISPLAY AND ICONS	10	Viewing the Caller ID List	45
GETTING STARTED	11	Deleting a Caller ID Message	46
Setting up the Phone	11	Using the Caller ID Message List	47
Mounting the Base Unit on a Wall	16	Call Waiting Deluxe Features	48
About the Menu Options	18	EXPANDING YOUR PHONE	49
Setting up the Menu	21	Expanding Your Phone	49
BASICS	28	Connecting the Charger	49
Making and Receiving Calls	28	Register the Handset to the Base	50
Placing a Call on Hold	29	Using the DirectLink Mode	51
Redialing a Call	30	Room Monitor	51
Adjusting the Handset Ringer, Earpiece and Speaker Volume	31	3-Way Conferencing	52
Mute Microphone	32	Intercom/Call Transfer Feature	52
Tone Dialing Switch-over	32	Replacing the Base	53
Traveling Out-of-Range	32	ADDITIONAL INFORMATION	54
Clarity Booster	33	Changing the Digital Security Code	54
Privacy Mode	33	Installing the Beltclip	54
Find Handset	34	Headset Installation	54
Flash and Call Waiting	34	Note on Power Sources	55
Using One Touch Voice Mail Access	35	Maintenance	55
PHONEBOOK	36	General Information	56
Phonebook	36	TROUBLESHOOTING	57
Storing Phone Numbers, Names, Distinctive Rings, and Speed Dial	36	Liquid Damage	59
Steps for Entering Names and Special Characters	38	PRECAUTIONS & WARRANTY	60
Viewing the Phonebook	40	I.C. NOTICE	62
Making Calls Using the Phonebook	41	INDEX	63
Speed Dialing	41	MEMORY LIST	64
Editing or Erasing a Stored Name, Phone Number, Distinctive Ring, and Speed Dial	42		

Welcome

Congratulations on your purchase of the Uniden Multi-Handset Cordless System telephone. This unit is different from conventional cordless telephones. When the base unit is connected to AC power and a telephone line, it can support up to 4 handsets. Using extra handsets, you can establish a 3-way conference call (2 handsets and an outside line), while two other handsets are making an intercom call. You can now place a fully featured cordless handset anywhere in your home or office where AC power is available to connect the handset chargers.

Note: Some illustrations in this manual may differ from the actual unit for explanation purposes.



As an Energy Star[®] Partner, Uniden has determined that this product or product models meets the Energy Star[®] guidelines for energy efficiency. Energy Star[®] is a U.S. registered mark.

Note: Energy Star[®] applies to DCT646 only.

Features

- 2.4GHz Frequency Hopping Spread Spectrum
- 4 Multi-Handset Expandability
- Hands Free Speakerphone in the Handset
- Call Waiting Deluxe
- Caller ID/Caller ID On Call Waiting
- 100 Dynamic Memory Location (Phonebook & Caller ID)
- Trilingual Handset Display Menus (English, French, and Spanish)
- Call Transfer between Handsets
- 20 Distinctive Ring Options (10 ringer tones and 10 melody ringers)
- Mute Feature
- Flash and Pause
- 88 Channel Auto Scan
- DirectLink™ Mode
- Voice Mail Access
- Room Monitoring Feature
- Battery Level Indicator
- Clock Display

This series features include **AutoTalk™** and **AutoStandby™**. AutoTalk allows you to answer a call by just removing the handset from the cradle so you don't have to waste time pushing buttons. AutoStandby allows you to hang up by simply returning the handset to the cradle.

To protect you against mis-billed calls, which might result from your phone being activated by other equipment, this series has **Random Code™** digital security, which automatically selects one of over approx. 130,000 digital security codes for the handset and base.

Frequency Hopping Spread Spectrum (FHSS) technology improves calling range and clarity, and eliminates cross talk. Because it rapidly changes transmission frequencies within the 2.4GHz bandwidth, this cordless phone helps reduce the possibility of eavesdropping.

DirectLink mode is used when you have 2 or more handsets. You can use your handsets as transceivers.

Be sure to visit our web site: www.uniden.com

Uniden® is a registered trademark of Uniden America Corporation.

AutoTalk, AutoStandby, DirectLink, and Random Code are trademarks of Uniden America.

Terminology

- **Standby Mode** - The handset is not in use and **talk/flash** has not been pressed.
- **Talk Mode** - The handset is not in the cradle and **talk/flash** or **speaker** has been pressed enabling a dial tone. Talk appears on the display.

Controls & Functions

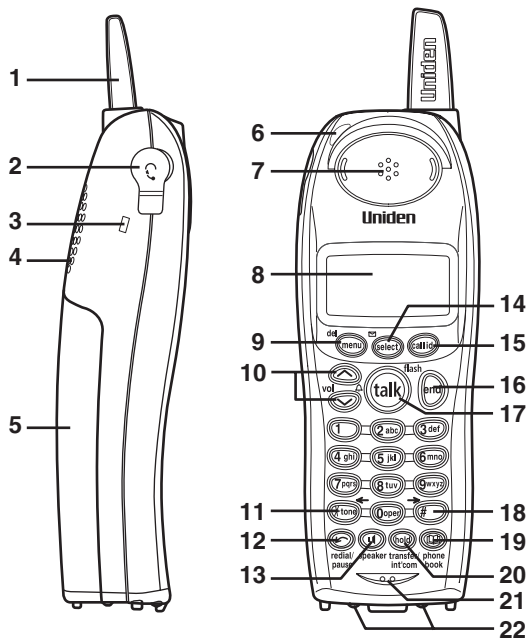

1. Handset Antenna
2. Headset Jack Cover
3. Beltclip Hole
4. Hands-Free Speaker
5. Handset Battery Compartment
6. New Message LED
7. Handset Earpiece
8. LCD Display
9. **Menu/del** (delete) Key (P. 21 / P. 30, 42, 46)
10. **△ (ring)/vol** (volume) and **∧/∨** (P.31/P.21)
 - a. ringer and volume control
 - b. scroll keys for display screen
11. ***/tone/←** Key (P. 22 / P. 32 / P. 39)
12. **↶ redial/pause** Key (P. 30/ P. 28)
13. **🔊 speaker** Key (P. 28)
14. **Select/✉** (voice mail) Key (P. 21 / P. 35)
15. **Call id** (Caller ID) key (P. 45)
16. **End** Key (P. 28)
17. **Talk/flash** Key (P. 28 / P. 34)
18. **#/→** Key (P. 22 / P. 39)
19. **📖** (Phonebook) Key (P. 36)
20. **Hold/transfer/int'com** (Intercom) Key (P. 29 / P. 53 / P. 52)
21. Handset Microphone
22. Handset Charging Contacts

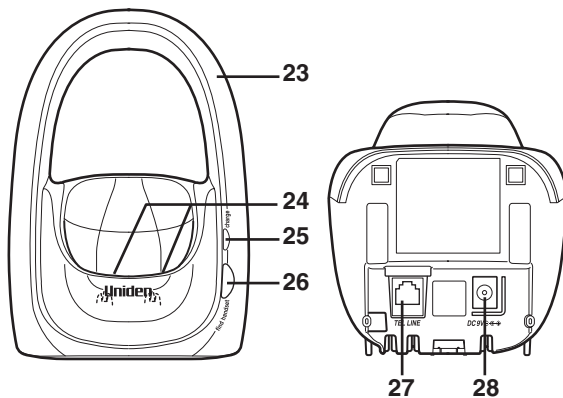

- 23. Base Antenna
- 24. Base Charging Contacts
- 25. **Charge** LED
- 26. **Find handset** Key (P. 34)
- 27. **TEL LINE** Jack
- 28. **DC IN 9V** Jack

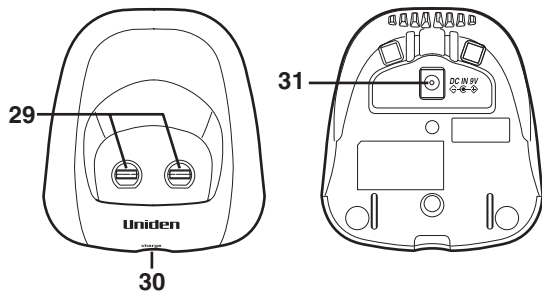

For DCT646-2 only

- 29. Charging Contacts
- 30. **Charge** LED
- 31. **DC IN 9V** Jack

Display and Icons

Example of the standby mode display

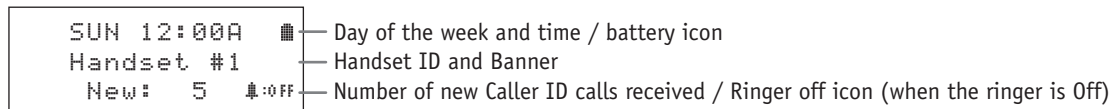

ICON	STATUS	DESCRIPTION
	Standby/Talk	Battery icons indicate the handset battery status. This icon cycles depending on the battery status (empty, low, medium, and full).
	Standby	Ringer off icon indicates that ringer is turned off.
	Talk	Mute icon appears when you mute the handset.
	Talk	Speaker icon appears when the handset speaker phone is used.
	Talk	Booster icon appears when the Clarity Booster feature is in use.
	Talk	Privacy icon appears when the Privacy Mode is turned on.

Setting up the Phone

Do the following steps:

- A. Choose the best location.
- B. Install the rechargeable battery pack into the handset.
- C. Connect the base unit.
- D. Choose the dialing mode.

A. Choose the best location

Before choosing a location for your new phone, read "Installation Considerations" on page 61. Here are some important guidelines you should consider:

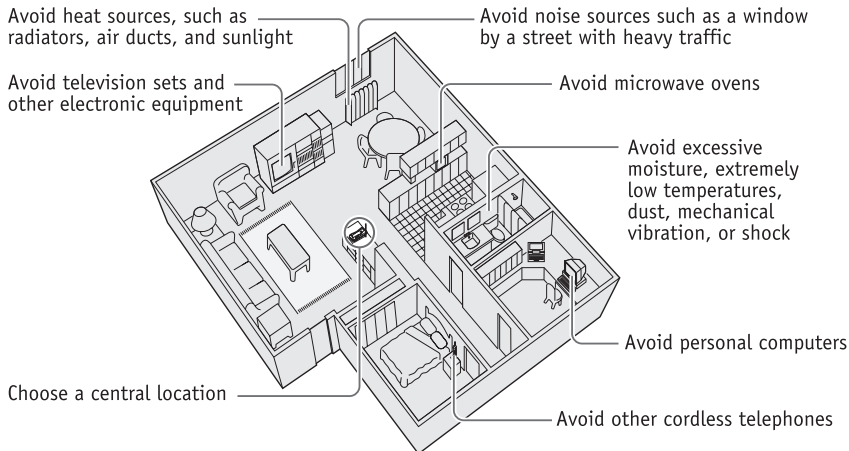

If your home has specially wired alarm equipment connected to the telephone line, be sure that installing the system does not disable your alarm equipment.

If you have questions about what will disable alarm equipment, contact your telephone company or a qualified installer.



- Use only the Uniden (BT-446) rechargeable battery pack supplied with your cordless telephone.

- Replacement battery packs are also available through the Uniden Parts Department at (800) 554-3988, Monday thru Friday from 8:00 a.m. to 5:00 p.m. or online at www.uniden.com

B. Install the rechargeable battery pack into the handset

Charge the handset battery pack for at least 15-20 hours before using your new cordless telephone for the first time! The handset is powered by a rechargeable battery pack. The battery recharges automatically when the handset is placed in the base unit. To maximize the charge capacity of your battery pack, DO NOT plug the telephone cord into the base unit and wall jack until the battery is fully charged.

- 1) Press down on the handset battery case cover (use the finger indentation for a better grip) and slide the cover downward to remove.
- 2) Plug the battery pack connector (red & black wires) into the jack inside the battery compartment (the connector notches fit into the grooves of the jack only one-way). Match the wire colors to the polarity label in the battery compartment, connect the battery, and listen for a click to insure connection.
- 3) Make sure you have a good connection by slightly pulling on the battery wires. If the connection is secure, the battery jack will remain in place.
- 4) Place the battery case cover back on the handset by sliding it upwards until it clicks into place.
- 5) Place the handset in the base unit for 15-20 hours without interruption. The base unit's LED light (labeled charge) illuminates once the handset is placed in the base. The LED light will illuminate whether the battery pack is connected or not.

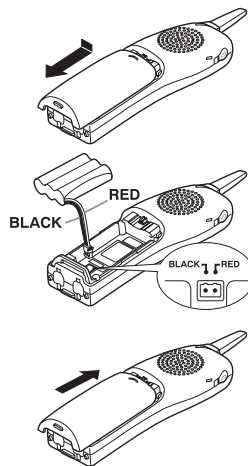

If the base **charge** LED light does not illuminate:

- Check to see if the AC adapter is plugged into the base unit and the electrical wall outlet properly (use only the supplied AC adapter. Do not use any other AC adapter).
- Check to see if the handset is sitting correctly in the base and making good contact with the base unit's charging contacts.

Low battery alert

When the battery pack is very low and need to be charged, the phone is programmed to eliminate functions in order to save power.

The battery pack needs to be charged when:

- The empty battery icon appears.
- Low Battery appears in the display.

If the phone is in standby mode, none of keys will operate. If you are on a call, complete your conversation as quickly as possible, and return the handset to the cradle.

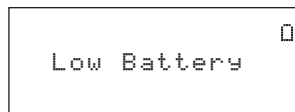

Cleaning the battery charging contacts

To maintain a good charge, it is important to clean the charging contacts on both the handset and the base unit once a month. Using water only, dampen a cloth to clean the charging contacts. Then make sure to go back over the charging contacts with a dry cloth before returning the handset to the base to charge.

Caution: Do not use paint thinner, benzene, alcohol, or other chemical products. Doing so may discolor the surface of the telephone and damage the finish.

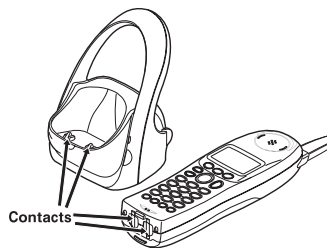

- Even when the battery pack is not being used, it will gradually discharge over a long period of time. For optimum performance, be sure to return the handset to the base unit after a telephone call.
- **Standby Mode** - The handset is not in use and *talk/flash* has not been pressed.
- **Talk Mode** - The handset is not in the cradle and *talk/flash* or *speaker* has been pressed enabling a dial tone. Talk appears on the display.



- Use only the supplied [AD-800] AC adapter. Do not use any other AC adapter.
- Place the power cord so that it does not create a trip hazard or where it could become chafed and create a fire or electrical hazard.

C. Connect the base unit

- 1) Connect the AC adapter to the **DC IN 9V** jack and to a standard 120V AC wall outlet.

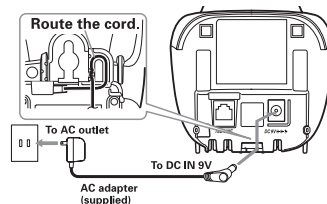

- 2) Set the base on a desk or tabletop, and place the handset in the base unit.

- 3) Make sure that the **charge** LED illuminates. If the LED does not illuminate, check to see that the AC adapter is plugged in and the handset makes good contact with the base charging contacts.



- Connect the AC adapter to a continuous power supply.
- Place the base unit close to the AC outlet so that you can unplug the AC adapter easily.

- After installing the battery pack in the handset, charge your handset at least **15-20 hours before plugging into the phone line.**

- 4) Once the handset battery pack is fully charged, connect the telephone line cord to the **TEL LINE** jack and to a telephone outlet.



- If your telephone outlet isn't modular, contact your telephone company for assistance.

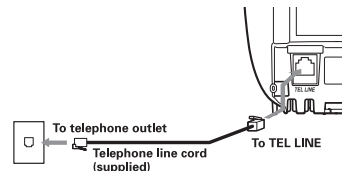

D. Choose the dialing mode

Most phone systems use tone dialing, which sends DTMF tones through the phone lines. However some phone systems still use pulse dialing such as in rural areas. The default setting is tone dialing. Depending on your dialing system, set the dial mode. To set the dial mode, see “Setting the Dial Mode” on page 26.

- If you are not sure of your dialing system, set the unit to tone dialing. Make a trial call. If the call connects, leave the setting as is, otherwise set the unit to pulse dialing.
- If your phone system requires pulse dialing and you need to send DTMF tones in certain situations during a call, you may Switch Over to tone dialing (refer to “Tone Dialing Switch-over” on page 32).



DO NOT use an AC outlet controlled by a wall switch.

Mounting the Base Unit on a Wall

Standard wall plate mounting

This phone can be mounted on any standard wall plate.

- 1) Plug the AC adapter into the **DC IN 9V** jack.
- 2) Wrap the AC adapter cord inside the molded wiring channel as shown.
- 3) Plug the AC adapter into a standard 120V AC wall outlet.
- 4) Plug the telephone line cord into the **TEL LINE** jack. Wrap the cord inside the molded wiring channel as shown.
- 5) Plug the telephone line cord into the telephone outlet.
- 6) Align the mounting slots on the base with the mounting posts on the wall. Then push in and down until the phone is firmly seated.

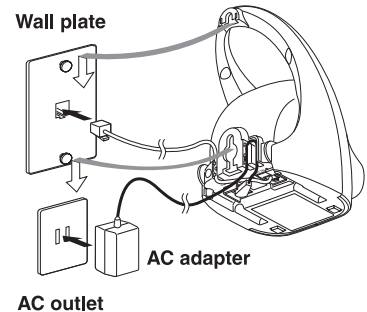

Direct wall mounting

If you don't have a standard wall plate, you can mount your phone directly to the wall. Before doing this, consider the following:

- Avoid electrical cables, pipes, or other items behind the mounting location that could cause a hazard when inserting screws into the wall.
- Try to mount your phone within 5 feet of a working phone jack to avoid excessive lengths.
- Make sure the wall material is capable of supporting the weight of the base and handset.
- Use #10 screws (minimum length of 1-3/8 inches) with anchoring devices suitable for the wall material where the base unit will be placed.

- 1) Insert two mounting screws into the wall (with their appropriate anchoring device), 3-15/16 inches apart. Allow about 1/8 of an inch between the wall and screw heads for mounting the phone.
- 2) Refer to steps 1 through 6 on page 16 to mount the telephone.

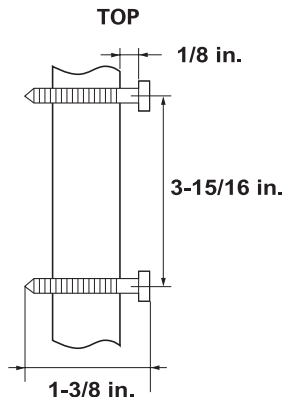



During Global Setup and System Reset, make sure your cordless phone is in standby mode (not in use), and all handsets are within range of the main base unit.

About the Menu Options

There are 5 main menu options, (**DirectLink Mode**, **Room Monitor**, **Handset Setup**, **Global Setup** and **System Reset**) and 16 submenu options.

Summary of Main Menu and Submenu Options

DirectLink Mode

DirectLink Mode allows a pair of handsets to work without the base unit, for direct handset-to-handset communication. Use them at sporting events or while shopping to stay in contact with family members or friends. You must set the two handsets to DirectLink Mode to utilize this feature.

Room Monitor

This feature only works if you have two or more handsets, allowing you to monitor sounds in another room (see page 22 for setup). One handset is placed in the desired room to monitor (acts as remote mic), and the other is placed near listener (remote speaker). This is useful for monitoring child activities.

Handset Setup

The following submenu options must be set separately for each handset.

Submenu option	Description
Edit Voice Mail	Program or delete the voice mail access number (see page 22).
Ringer Tones (Default is Flicker)	Adjusting the ringer tone (tone your phone makes when ringing) (see page 23).
Distinct. Ring (Default is on)	Set the distinctive ring (see page 23). "Distinctive Ringer" allows you to preset memory locations with a designated ring tone. When an incoming call is received and the Caller ID information matches the information in one of the memory locations, the distinctive ring that has been stored for that particular Caller will sound. If you have set multiple memory locations with distinctive rings, switching the setting to "Distinctive Off" will result in no distinctive ringing. All incoming calls will have a normal ring tone. Switching to "Distinctive On" will activate all programmed distinctive ring memory locations.
AutoTalk (Default is off)	Allows you to answer the phone without pressing talk/flash or speaker . When the AutoTalk is set to on, simply remove the handset from the cradle and the phone automatically answers the call (see page 23).
Anykey Answer (Default is off)	Allows you to answer the phone without pressing talk/flash or speaker . When the Anykey Answer is on, you can answer a call by pressing any number key, */tone/← , or #/→ on the handset (see page 24).
Banner (True Banner)	Customize your handset(s) by giving it a banner name. The name will be displayed on the LCD screen during standby mode, Intercom, Transfer, Room Monitor and Copy Phonebook operation. The banner name will be displayed on the receiving handset as well (see page 24).
Language (Default is English)	The menu display options can be set to English, French or Spanish for easy setup use (see page 24).
Key Touch Tone (Default is on)	Allows you to set your phone's key touch-tone to on or off (tone your keypad makes when keys are pressed) (see page 24).

Global Setup

If you change one of the Global settings, you change the setting for all additional handsets. Only one handset can change Global settings at a time.

Submenu option	Description
Day & time	Set the day and time of your display (see page 25).
CIDCW (Default is CW on/CWDX off)	Set the Caller ID on Call Waiting (CIDCW) setting. CIDCW performs the same as regular Caller ID on a call waiting number (see page 25). Call Waiting Deluxe allows you to handle call waiting calls in seven different ways (see page 48).
Area Code	Store or edit the area code. If you enter a 3-digit area code number in the "Area Code" option, your local area code does not appear in the Caller ID message. For calls received from outside your local area code, you will see a full 10-digit number (see page 25). Note: If your calling area requires 10-digit dialing, do not program this option.
Dial Mode (Default is tone)	Set the dial mode to tone or pulse (see page 26). Most phone systems use tone dialing, which send DTMF tone through phone line. The default is tone dialing. Depends on your dialing system, set the dial mode.
Copy Phonebook	Allow you to transfer the phonebook data stored in one handset to another handset (see page 26).
Voice Mail Tone (Default is on)	If your service does not support SDT message signal, set your VMWI (Visual Message Waiting Inculcator) not to detect SDT message signal (see page 27).

System Reset

System Reset is used to clear the handset's ID from the main base unit, or the base ID from the handset.

Submenu option	Description
Deregister HS	Clear the handset ID from the base. Use this option, for example, when you change the digital security code (see page 27).
Replacing Base	Clear the base ID. Use this option, for example, if you wish to deregister the base to use the handset with another base of the DSS series (DCT646/DCT6465/DCT648/DCT6485 series) (see page 27).

Setting Up the Menu

Entering the Menu

- 1) Press the **menu/del** key in standby mode.
- 2) Use **ring/vol/∧** or **ring/vol/∨** to move the pointer to a desired main menu (DirectLink Mode, Room Monitor, Handset Setup, Global Setup, and System Reset).
- 3) Press **select/☒** to select the desired main menu.
- 4) Use **ring/vol/∧** or **ring/vol/∨** to select a desired submenu, and then press **select/☒** to enter.
In the submenu, use **ring/vol/∧** or **ring/vol/∨** to select an item.
Press **select/☒** to confirm your selection. For detailed instructions, see the following sections for the desired submenu.
- 5) To exit the menu, press **end** or place the handset to the cradle.

```

▶ DirectLink Mode
  Room Monitor
  Handset Setup
  
```

DirectLink Mode

Using the DirectLink Mode

- 1) Enter the DirectLink Mode menu (see "Entering the Menu" on page 21). To enter DirectLink mode press [SELECT] appears.
- 2) Press **select/☒** to enter the DirectLink mode. You will hear a confirmation tone, and DirectLink Mode Complete appears.
- 3) To return back to the normal mode, exit the DirectLink mode. To exit the DirectLink mode, press **menu/del**, and then **select/☒**, or return the handset to the cradle.

```

To enter
DirectLink mode
press [SELECT]
  
```



This is an example, if you have handset #1 and #2.

Room Monitor

Using Room Monitor

- 1) Enter the Room Monitor menu (see "Entering the Menu" on page 21).
To Room Monitor appears.
- 2) Select the handset you want to monitor by using **ring/vol/∧** or **ring/vol/∨**.
- 3) Press **select/☒**.
RoomMonitor appears, and you hear sounds in the room where the handset is installed.
- 4) To finish the Room Monitor, press **end** or return the handset to the cradle.

```
To Room Monitor
▶Handset #2
```

```
To Room Monitor
▶Handset #2
```

Handset Setup

Programming your Voice Mail Access Number

- 1) Enter the Handset Setup menu, and then the Edit Voice Mail submenu (see "Entering the Menu" on page 21).
Edit V_mail No. appears.
- 2) Enter your personal access number using the number keypad (**0-9**), ***/tone/←**, **#/→**, **menu/del**, or **redial/pause** (up to 20 digits).
- 3) Press **select/☒**. You will hear a confirmation tone.

```
Edit V_mail No.
1234567890■
```

To delete the current Voice Mail Access Number, delete all numbers in step 2 using **menu/del** and **select/☒**.

Selecting a Ringer Tone

- 1) Enter the Handset Setup menu, and then the Ringer Tones submenu (see "Entering the Menu" on page 21).

```
Ringer Tones
▶ Flicker
  Clatter
```

There are 10 ringer tones or 10 melodies to choose from.

- Ringers [Flicker, Clatter, Soft Alert, Wake Up, Light Bug, Beep Boop, Tone Board, Chip Chop, Party Clap, Reminder]
 - Melodies [Beethoven's Symphony #9 (Beethoven9), For Elise (Elise), We Wish You A Merry Christmas (Merry-Xmas), Home Sweet Home (Hm Swt Hm), Lorri Song #6 (Lorri Song), When the Irish Eyes Are Smiling (Irish Eyes), Aura Lee, Let Me Call You Sweet Heart (Sweetheart), Star Spangled Banner(Star Spngl), Old MacDonald(Old MacDld)]
- 2) Press **ring/vol/▲** or **ring/vol/▼** to move the pointer. You will hear the ringer or melody as you scroll through the options.
 - 3) Press **select/☒**. You will hear a confirmation tone.

Distinctive Ringer Setup

- 1) Enter the Handset Setup menu, and then the Distinct. Ring submenu (see "Entering the Menu" on page 21).
- 2) Press **ring/vol/▲** or **ring/vol/▼** to select On or Off.
- 3) Press **select/☒**. You will hear a confirmation tone.

```
Distinctive Ring
▶ On
  Off
```

Setting the AutoTalk

- 1) Enter the Handset Setup menu, and then the Auto Talk submenu (see "Entering the Menu" on page 21).
- 2) Press **ring/vol/▲** or **ring/vol/▼** to select On or Off.
- 3) Press **select/☒**. You will hear a confirmation tone.

```
Auto Talk
  On
▶ Off
```

Setting the Anykey Answer

- 1) Enter the Handset Setup menu, and then the Anykey Answer submenu (see "Entering the Menu" on page 21).
- 2) Press **ring/vol/∧** or **ring/vol/∨** to select On or Off.
- 3) Press **select/☒**. You will hear a confirmation tone.

```
Anykey Answer
On
▶ Off
```

Setting the True Banner

- 1) Enter the Handset Setup menu, and then the Banner submenu (see "Entering the Menu" on page 21).
- 2) Use the number keypad (**0-9**), ***/tone/←**, **#/→**, or **menu/del** to enter or edit the name.
- 3) Press **select/☒**. You will hear a confirmation tone.

```
Banner
■----- #1
```

Selecting a Language

- 1) Enter the Handset Setup menu, and then the Language submenu (see "Entering the Menu" on page 21).
- 2) Press **ring/vol/∧** or **ring/vol/∨** to choose English, Français (French), or Español (Spanish).
- 3) Press **select/☒**. You will hear a confirmation tone.

```
Language
▶ English
Français
```

Setting the Key Touch Tone

- 1) Enter the Handset Setup menu, and then the Key Touch Tone submenu (see "Entering the Menu" on page 21).
- 2) Press **ring/vol/∧** or **ring/vol/∨** to select On or Off.
- 3) Press **select/☒**. You will hear a confirmation tone.

```
Key Touch Tone
▶ On
Off
```

Global Setup

Setting Day and Time

- 1) Enter the Global Setup menu, and then the Day & Time submenu (see "Entering the Menu" on page 21).
- 2) Press **ring/vol/▲** or **ring/vol/▼** to select the day of the week, and then press **select/☒**.
- 3) Press **ring/vol/▲** or **ring/vol/▼** to set hour and then press **select/☒**.
- 4) Press **ring/vol/▲** or **ring/vol/▼** to set minute and then press **select/☒**.
- 5) Press **ring/vol/▲** or **ring/vol/▼** to choose AM or PM, and then press **select/☒**.
You will hear a confirmation tone.

```
Day & Time
SUN 12:00 AM
[+ / ↑ / ↓ / → / SELECT]
```

Setting CIDCW (Caller ID on Call Waiting)

- 1) Enter the Global Setup menu, and then the CIDCW submenu (see "Entering the Menu" on page 21).
- 2) Press **ring/vol/▲** or **ring/vol/▼** to select CW On/CWDX On, CW On/CWDX Off, or CW Off/CWDX Off, and then press **select/☒**. You will hear a confirmation tone.

```
CIDCW
▶ CW On / CWDX On
  CW On / CWDX Off
```

Setting the Area Code

- 1) Enter the Global Setup menu, and then the Area Code submenu (see "Entering the Menu" on page 21).
- 2) Press the number keypad (**0-9**) to enter a 3-digit area code.
- 3) Press **select/☒**. You will hear a confirmation tone.

```
Area Code
■ _ _
```



- When a Global setting is changed from one handset, this affects all registered handsets.
- For setting the day and time, the idle time-out is extended to 2 minutes.

- When the area code has already been stored in memory, the stored area code will be displayed. To change it, use **menu/del** and number keys to enter the new area code.



•If you receive a call or set up the Global Setup menu, the transfer will be canceled.

•If an error occurs, the phonebook locations transferred before the error were stored in the receiving handset. Unavailable appears on the display.

•When the memory of the receiving handset is full, Not enough memory in Receiving Handset appears. You cannot transfer the phonebook location.

Setting the Dial Mode

- 1) Enter the Global Setup menu, and then the Dial Mode submenu (see "Entering the Menu" on page 21).
- 2) Press **ring/vol/∧** or **ring/vol/∨** to change the select, Tone or Pulse (the initial setting is Tone).
- 3) Press **select/☒**. You will hear a confirmation tone.

```
Dial Mode
▶Tone
Pulse
```

Copy Phonebook

- 1) Enter the Global Setup menu, and then the Copy Phonebook submenu (see "Entering the Menu" on page 21).
- 2) Press **ring/vol/∧** or **ring/vol/∨** to choose One memory or All Memory, and then press **select/☒**.
If you choose All Memory, go to step 4.
- 3) Press **ring/vol/∧** or **ring/vol/∨**, or the number keypad (**0-9**) to select the phonebook location you want to export, and then press **select/☒**.
- 4) Press **ring/vol/∧** or **ring/vol/∨** to select the handset to which you want transfer the phonebook locations, and then press **select/☒**.

```
Copy Phonebook
▶One Memory
All Memory :xxx
```

If you choose All Memory in the step 2, Are you sure? appears.

Press **ring/vol/∧** or **ring/vol/∨** to select Yes, and then press **select/☒**.

The phonebook locations will be transferred to the handset. On the receiving handset, Receiving and the handset name appear. When the transfer complete, Done! appears on the handset.

Voice Mail Tone

- 1) Enter the Global Setup menu, and then the Voice Mail Tone submenu (see "Entering the Menu" on page 21).
- 2) Press **ring/vol/▲** or **ring/vol/▼** to set the voice message indication (SDT message signal) to On or Off.
- 3) Press **select/☒**. You will hear a confirmation tone.

```
Voice Mail Tone
▶ On
  Off
```

System Reset

De-register the Handset

- 1) Enter the System Reset menu, and then the Deregister HS submenu (see "Entering the Menu" on page 21).
- 2) Press **ring/vol/▲** or **ring/vol/▼** to select the handset ID to be de-registered from the list, and then press **select/☒**. Deregister HS? appears.
- 3) Press **select/☒**. You will hear a confirmation tone. When de-registration is complete, Deregistration Complete appears.
- 4) After de-registering the handset, move to "Replacing the Base Setting" below.

```
Which Handset?
▶ Handset   #1
  Handset   #2
```

```
Deregister HS?
Yes
▶ No
```

Replacing the Base Setting

- 1) Enter the System Reset menu, and then the Replacing Base submenu (see "Entering the Menu" on page 21). Replace base? appears.
- 2) Press **select/☒**. You will hear a confirmation tone. The base information will be deleted. When replacing the base is complete, Place handset on main base to register appears, register the handset to the new base (see page 50).

```
Replace base?
Yes
▶ No
```



Make sure to perform the Replacing Base after de-register the handset.



- To set Autotalk, see page 23 or to set Anykey Answer see page 24.
- The handset microphone is located at the bottom of the handset (see "Controls and Functions" on page 8). Position yourself as near to the handset as possible and speak clearly.
- If the line is in use by another handset(s), Line In Use appears in the display of all registered handset's display, that are not in use.

Making and Receiving Calls

This handset has a built-in speakerphone that allows you to have a hands-free conversation. This feature allows you to communicate easily while performing other tasks, such as cooking.  appears during hands-free conversations.

You can easily switch a call from normal conversation to hands-free conversation. To switch a call, press **speaker** during the call.

	From the Handset	
	Normal conversation	Hands-free conversation
To answer a call	Handset On the Cradle Pick up the handset (AutoTalk) or pick up the handset and press talk/flash . Handset Off the Cradle Press any number key, */tone/← , or #/→ (Any Key Answer), or press talk/flash .	Handset Off the Cradle Press speaker .
To make a call	Handset Off the Cradle 1) Press talk/flash . 2) Listen for the dial tone. 3) Dial the number. OR Dial the number, and then press talk/flash .	Handset Off the Cradle 1) Press speaker . 2) Listen for the dial tone. 3) Dial the number. OR Dial the number and then press speaker .
To hang up	Press end or return the handset to the cradle (AutoStandby).	
To enter a pause within the dialing sequence	When you dial the number in standby mode, press redial/pause . P appears in the display, which represents a pause.	

Placing a Call on Hold

- 1) During a call, press **hold/transfer/int'com**. The call will be put on hold.

```
Hold, to transfer
▶ Handset #2
  Handset #3
```

-  After 10 seconds of pressing **hold/transfer/int'com** or by pressing the **end** key, the handset display screen will read, Line On Hold.

- 2) To talk to the caller, press **talk/flash** or **speaker** on a handset. The phone will return back to the call.

```
SUN 12:00A ■
Handset #1
Line On Hold
```



- You can hold a call for 5 minutes, when 5 minutes has passed, the call is disconnected and the phone returns to standby mode.
- While a call is on hold, CIDCW can not be received.



- If the number exceeds 32 digits, only the first 32 digits are retained in redial memory.
- If the redial memory is empty, you will hear a beep.

Redialing a Call

The last three phone numbers dialed can be quickly redialed.

Redialing from Standby Mode

- 1) Press **redial/pause** in standby mode.
- 2) Press **redial/pause** again. Each press of **redial/pause** will display one of the last three number redialed.
- 3) Press **talk/flash** or **speaker**. The selected number is dialed.
- 4) To hang up, press **end**.

Redialing from Talk Mode

- 1) Press **talk/flash** or **speaker**.
- 2) Press **redial/pause**. The last number dialed will be displayed and redialed. To hang up, press **end**.

Deleting a Redial Record

- 1) Press **redial/pause** in standby mode.
- 2) Press **redial/pause** repeatedly to display the number to be deleted.
- 3) Press **menu/del**.
- 3) Press **ring/vol/∧** or **ring/vol/∨** to choose **Yes**.
- 4) Press **select/☒**. The redialed number is deleted.

Storing a Redial Record

- 1) Press **redial/pause** in standby mode.
- 2) Press **redial/pause** repeatedly to display the number to be stored.
- 3) Press **select/☒**. **Store/Edit Name** appears.
- 4) To complete the setting, follow the steps 3-8 in "Storing Phone Numbers, Names, Distinctive Rings, and Speed dial" on page 36-37.

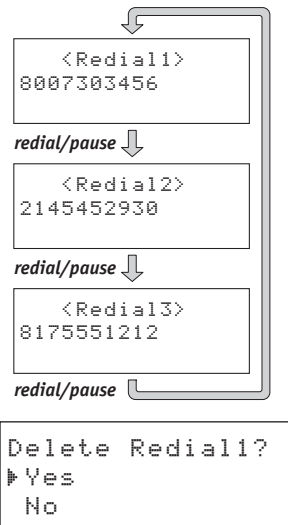

Adjusting the Handset Ringer, Earpiece and Speaker Volume

Handset ringer volume

Press the volume up key or volume down key (labeled as Δ /**vol**/ \wedge or Δ /**vol**/ \vee in standby mode to select one of three ringer volume (off, low, or high).

Earpiece and speaker volume

Pressing the volume up key or volume down key (labeled as Δ /**vol**/ \wedge or Δ /**vol**/ \vee key) during a call will change the earpiece volume of the handset. This setting will remain in effect after the telephone call has ended.

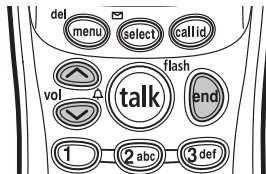

note

Standby Mode - The handset is not in use and **talk/flash** has not been pressed.



When you press volume up key (**ring/vol**/ \wedge) in the maximum volume level or volume down key (**ring/vol**/ \vee) in the lowest volume level, an error tone sounds.

Ringer Mute

You can temporarily mute the incoming ring. When the handset is off the cradle and the phone is ringing, press **end**. The incoming ring will return to the previous setting starting with the next incoming call.

Mute Microphone

You can temporarily turn off the microphone so that the person you are talking with cannot hear you.

1) Press **menu/del** during talk mode (while phone is in use).

2) Press **ring/vol/∧** or **ring/vol/∨** to move the pointer to **Mute** and then **select/☒**.

Mute On and  appear in the display. To cancel muting, repeat above step again when **Mute** is set to on, **Mute Off** appears.

note

- The tone feature only applies when the dial mode is set to pulse.
- This special number can be stored in a memory location. This is referred to as Chain Dialing (see page 43).

Tone Dialing Switch-over

Some telephone companies use equipment that requires pulse dialing (sometimes referred to as rotary dialing). If you need to enter tone dialing digits, you can switch-over to tone dialing during the call. This feature is useful when you need tone dialing to use automated systems, for example, entering your bank account number after you have called your bank.

Initially make your call with the pulse dialing mode. Once your call connects, press ***/tone/←**. Enter the desired number. These digits will be sent as tone dialing. Once the call ends, the tone mode is canceled and pulse dialing mode resumes.

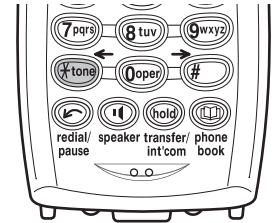

Traveling Out-of-Range

During a call, as you begin to move your handset too far from your base unit, noise may increase. If you pass the range limits of the base unit, you will hear a beep and see **Out of Range** on the display, and then the handset returns to standby mode. You may return to the call if you move your handset within the range limits of the base and press **talk/flash** or **speaker** within 30 seconds.

Clarity Booster

If you encounter interference while using your phone, you can manually improve the sound by setting the Clarity Booster to on. **This works only when the phone is in use.**

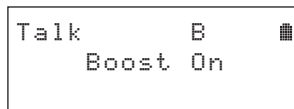

- 1) Press **menu/del** during talk time (while phone is in use).
- 2) Press **ring/vol/∧** or **ring/vol/∨** to move the pointer to Clarity Boost, and then **select/☒**.

Boost On and B appear in the display.

To turn Off the Clarity Booster, repeat above step again when the Clarity Booster is on, Boost Off appears.

Privacy Mode

Privacy Mode allows you privacy, and guarantee of no interruption from other registered handsets. **This works only when the phone is in use.**

- 1) Press **menu/del** during talk time (while phone is in use).
- 2) Press **ring/vol/∧** or **ring/vol/∨** to move the pointer to Privacy Mode, and then **select/☒**.

Privacy Mode On and  appear in the display.

To exit the Privacy Mode, repeat above step again when the Privacy Mode is on.

Privacy Mode Off appears.

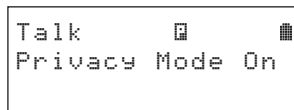



- If the battery pack is completely drained, the handset will not beep when paging.

Find Handset

To locate the handset, press **find handset** on the base when the base is in standby mode. All registered handsets beeps for 60 seconds, and "Paging" appears on the handset display. To cancel paging, press any key on the handset or **find handset** on the base.

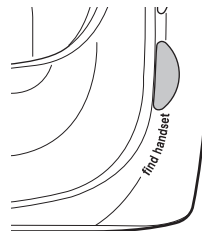

Flash and Call Waiting

- You must subscribe through your local telephone company to receive Call Waiting or Caller ID on Call Waiting service.

If you have Call Waiting service and a call waiting tone sounds while you are on a call, press **talk/flash** to accept the waiting call. There is a short pause, and then you will hear the new caller. To return to the original caller, press **talk/flash** again.

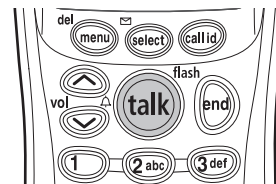



Using One Touch Voice Mail Access

If you subscribe to voice mail service, you can use your phone to access your voice mailbox. The new message LED flashes whenever you have messages waiting in your voice mailbox. Just program the handset with your access number, and you can get your messages at the touch of a button on the handset. (The voice mail service provider will supply you with the access number. This number may be simply a phone number. Refer to the provider's literature).

•To program or delete your Voice Mail Access Number, See page 22.

Dialing your Voice Mail Service

Once you've programmed your personal access number, you can dial your mailbox with the touch of a button. When you have messages, simply pick up the handset and press **select**/. If you have not entered the access number or it has been deleted, when you press the **select**/, No Number Stored To store number Press [MENU] appears and you will hear a beep. The phone returns to standby mode.

Voice Mail Access

The new message LED on the handset is designed to work with your voice mail service provided by your local telephone company. The LED flashes when you have new incoming messages in the voice mail service. You may need to occasionally reset the indicators if they remain on after you've retrieved your messages. To reset the indicators, when the phone is in standby mode press and hold **find handset** on the base until the paging sound stops (about 5 seconds).



You must subscribe to voice mail service from your telephone company in order to use this feature. The voice mail service company will provide you with the access number.



- Your phone has 100 memory locations for Caller ID messages or stored Phonebook numbers.
- Selecting a speed dial location where a number is already stored releases the old number's speed dial setting. The new number will be stored in the speed dial location.
- When the memory is full, you will hear a beep and **MEMORY Full** appears. You cannot store names and numbers.
- The pause key counts as one digit. Pressing **redial/pause** more than once increases the length of the pause between numbers. Each pause represents a 2 second delay.

Phonebook

The Phonebook allows you to dial a number using just a few key presses. Your phone stores names/numbers in the phonebook memory location, and you can search names in alphabetical order. You have a total of 100 locations that can be used for the phonebook (including the speed dials) and Caller ID messages.

Storing Phone Numbers, Names, Distinctive Rings, and Speed Dial

- 1) When the phone is in standby mode, press **phonebook**.
The handset displays the following items:
(1st line) The number of the phonebook locations used
(2nd line) How to search (press the number keypad, **ring/vol/∧** or **ring/vol/∨**)
(3rd line) How to enter the storing operation (press the **select/☒** key)
- 2) Press **select/☒**, **Store/Edit Name** appears.
- 3) Enter the name (up to 16 characters) by using the number keypad (see the "Steps for Entering Names and Special Characters" on page 38).
If a name is not required, go to step 4. <No Name> will be used as the name.
- 4) Press **select/☒** to store the name, **Store/Edit No.** appears.
- 5) Press the number keypad to enter the phone number (up to 20 digits), press **select/☒** to store the number.

```
Phonebook :100
Search [A-Z/↑/↓]
Store [SELECT]
```

```
Store/Edit Name
Movies
```

```
Store/Edit No.
8007303456■
```

- 6) Distinctive Ring appears. Press **ring/vol/Λ** or **ring/vol/∇** to move the pointer to one of the Distinctive Ring options, and then press **select/☒**.

```
Distinctive Ring
▶No Selectn
Flicker
```



If you choose not to store a Distinctive Ring, simply select the "No Selectn" option.

- 7) Speed Dial appears. Press **ring/vol/Λ** or **ring/vol/∇** to move the pointer to select the Speed dial location (10 locations: SPD1-SPD0).

```
Speed Dial
▶No Selectn
SPD1:<Empty>
```



If you choose not to store the name/number as a Speed Dial, simply select the "No Selectn" option.

- 8) Press **select/☒**. You will hear a confirmation tone, and Done! appears in the display.

```
Movies
800-730-3456
♪Beethoven9/SPD1
```

Steps for Entering Names and Special Characters

Refer to the letters on the number keys to select the desired characters. With each press of a number key (**0-9**), the displayed character appears in the following order: upper case letters first, lower case letters next and finally the number corresponding to the key.

	Number of times key is pressed								
keys	1	2	3	4	5	6	7	8	9
1	1								
2 abc	A	B	C	a	b	c	2		
3 def	D	E	F	d	e	f	3		
4 ghi	G	H	I	g	h	i	4		
5 jkl	J	K	L	j	k	l	5		
6 mno	M	N	O	m	n	o	6		
7 pqrs	P	Q	R	S	P	q	r	s	7
8 tuv	T	U	V	t	u	v	8		
9 wxyz	W	X	Y	Z	w	x	y	z	9
0 oper	&	()	<	>	/	(blank)	-	_
	.	,	:	?	!	@	'	"	*
	#	0							

If you make a mistake while entering a name

Use **/tone/←* or *#/→* to move the cursor to the incorrect character.

Press *menu/del* to erase the wrong character and then enter the correct character.

To delete all characters, press and hold *menu/del*.

For example, to enter **Movies**:

- 1) When the phone is in standby mode, press *phonebook*.
- 2) Press *select/☒*, Store/Edit Name appears.
- 3) Press **6** once, and then press *#/→* to move the cursor to the right.
- 4) Press **6** six times.
- 5) Press **8** six times.
- 6) Press **4** six times.
- 7) Press **3** five times.
- 8) Press **7** eight times.
- 9) When finished, press *select/☒*.

To continue to store the telephone number, proceed to step 5 on page 36.



If the next character uses the same number key, you must press *#/→* to move the cursor over. Otherwise the next time you press the number key, it changes the character that was previously set.

Viewing the Phonebook

Your phone stores names/numbers in the phonebook memory locations, and you can search names in alphabetical order. You can view the phonebook even while the phone is in use.

1) Press **phonebook**.

If you recall the phonebook during a call, Store [SELECT] will not appear.

```
Phonebook :100
Search [A-Z/↑/↓]
Store [SELECT]
```

2) Press **ring/vol/∧**, **ring/vol/∨**, or the number keypad to scroll through the phonebook locations. Phonebook locations appear in alphabetical order (from first to last when you press **ring/vol/∨**, from last to first when you press **ring/vol/∧**).

You can also use letters on the number keys to select the first letter of the desired name. Press a number key (**2-9** and **0**) once for the first letter, press twice for the second letter, and so on. The first location that begins with the letter you entered appears.

For example, to search for "Movies," press **6** once. Press **ring/vol/∧** or **ring/vol/∨**, until the phonebook location is displayed.

3) To finish the viewing operation, press **end** (or **phonebook** during a call).



During a call, don't press **end** or the call will be disconnected.

Making Calls Using the Phonebook

From Standby Mode

- 1) When the phone is in standby mode, view the phonebook location to dial (see "Viewing the Phonebook" on page 40).
- 2) Press **talk/flash** or **speaker**. The displayed number is dialed.
- 3) To hang up press **end**.

```
Movies
800-730-3456
↓Beethoven9/SPD1
```

From Talk Mode

- 1) Press **talk/flash** or **speaker**.
- 2) View the phonebook location to dial (see "Viewing the Phonebook" on page 40).
- 3) Press **select**/. The number in the displayed phonebook location is dialed.
- 4) To hang up press **end**.

Speed Dialing

If you store a phone number in a speed dial memory location (10 locations:SPD1 - SPD0), you can use the speed dialing feature. When the phone is in standby mode, press and hold a number key (0-9) associated with the speed dial until the phone number appears, then press **talk/flash** or **speaker**. The number stored in speed dial (SPD1 - SPD0) is dialed.

Editing or Erasing a Stored Name, Phone Number, Distinctive Ring, and Speed Dial

- 1) When the phone is in standby mode, press **phonebook**.
- 2) Press **ring/vol/∧** or **ring/vol/∨**, or the number keypad to view the phonebook locations (see "Viewing the Phonebook" on page 40).

```
Phonebook :100
Search [A-Z/↑/↓]
Store [SELECT]
```

a. Editing the Stored Data

- 1) When the phonebook location to be edited appears, press **select/☒**. Store/Edit Name appears.
- 2) Follow the steps 3 to 7 under "Storing Phone Numbers, Names, Distinctive Rings, and Speed Dial" on page 36 to complete the editing operation.
- 3) Press **select/☒**. You will hear a confirmation tone.

```
Store/Edit Name
Movies
```

b. Deleting the Stored Data

- 1) When the phonebook location to be deleted appears, press **menu/del**. Delete Memory? appears.
- 2) Press **ring/vol/∧** or **ring/vol/∨** to move the pointer to Yes.
- 3) Press **select/☒**. You hear a confirmation tone. Deleted! appears in the display.

```
Delete Memory?
  Yes
▶ No
```

Chain Dialing

The memory locations in the handset are not limited to phone numbers. You can also store a group of numbers (up to 20 digits), that you need to enter once your call connects. This is referred to as Chain Dialing.

An example of this is a bank account number. Store the account or special number in one of the phonebook locations. (Refer to "Storing Phone Numbers, Names, Distinctive Rings and Speed Dial" on page 36.) When you call your bank and you are prompted to enter the account number, scroll through your phonebook locations until you find your account number, and then press **select**/.



Caller ID and CIDCW (Caller ID on Call Waiting)

You must subscribe to Caller ID services through your local telephone provider to use these features.

When the telephone rings, the Caller ID feature allows you to view the caller's name, and phone number along with the date and time of call. With CIDCW (Caller ID on Call Waiting), you will hear a call waiting tone while you are on a call, and the Caller ID data is displayed. To accept the waiting call, press **talk/flash** (see page 34). Additionally, you can dial a number stored in the Caller ID list or save data to your Phonebook locations.

Important:

Memory locations for Caller ID messages and Phonebook locations (including Speed Dials) are common, you can store up to 100 in total. A Caller ID message is not stored when you have stored 100 of the phonebook locations. The earliest Caller ID message is overwritten when you have stored 100 of the phonebook locations and Caller ID messages in total.

The date and time received	10/12 11:20AM
Caller's name	Jane Smith
Caller's phone number	214-555-1234

- If you answer a call before the Caller ID message is received (for example, before the second ring), the Caller ID message will not appear.
- When the call is received via a telephone company that does not offer Caller ID service, the caller's phone number and name does not appear. (This includes some international calls.)
- When the call is via a private branch exchange (PBX), the caller's phone number and name may not appear.

- 1) When the Caller ID message is received, the display shows the caller's phone number along with the date and time. The incoming call information is stored in the Caller ID record. If the Caller ID service includes the caller's name, the name will appear in the display (up to 15 characters).

You may receive any one of the following messages:

When invalid data is received	Incomplete Data
When a private name is received	Private Name
When a private number is received	Private Number
When an unknown name is received	Unknown Name
When an unknown number is received	Unknown Number

- 2) When you pick up the phone, the display changes to **Talk**.
(AutoTalk feature is set to on).



Data errors appear as "I."

Viewing the Caller ID List

The Caller ID list stores information for incoming calls - even unanswered calls. You can store 100 of the Caller ID messages and Phonebook locations (including SpeedDials) in total. You can view the Caller ID list during a call or when the phone is in standby mode.

- 1) Press **call id**.
The summary screen appears. The screen shows the number of new messages and total messages.
- 2) To view the Caller ID messages in historical order (from new to old or from old to new), repeatedly press **ring/vol/v** to scroll through the messages from the latest to the earliest, or **ring/vol/^** to scroll back through the messages.
To view the Caller ID messages with alphabetical search, press the number key pad (**2-9** and **0**) with the letter associated with the first letter of the desired message.



Once you view the Caller ID list with alphabetical search, you cannot switch back to historical order (from new to old or from old to new) unless you exit and re-enter the operation.

- 3) To finish the viewing operation, press **end** (or **call/id** during a call).



- The number of calls from the same Caller ID appears next to the received time. Once you view the new message, the number will be cleared and disappear.
- During a call, don't press **end** or the call will be disconnected.



•Once the Caller ID data has been deleted, the information cannot be retrieved.

•**Standby Mode** -
The handset is not in use and *talk/flash* has not been pressed.

•**Talk Mode** -
The handset is not in the cradle and *talk/flash* or *speaker* has been pressed enabling a dial tone. Talk appears on the display.

Deleting a Caller ID Message

Deleting Information from the Caller ID List

- 1) When the phone is in standby mode, view the Caller ID information to be deleted (see "Viewing the Caller ID List" on page 45).
- 2) Press *menu/del*. Delete Caller ID appears.
- 3) Press *ring/vol/∧* or *ring/vol/∨* to choose Yes.
- 4) Press *select/☒*. You will hear a confirmation tone.

```
Delete Caller ID
▶ Yes
  No
```

Deleting all Caller ID names/numbers

- 1) When the phone is in standby mode, press *call id*.
- 2) Press *menu/del*. Delete All? appears.
- 3) Press *ring/vol/∧* or *ring/vol/∨* to choose Yes.
- 4) Press *select/☒*. You will hear a confirmation tone.

```
Caller ID
New : 5
Total: 25
```

```
Delete All?
  Yes
▶ No
```

Using the Caller ID Message List

Calling a party from the Caller ID list

From Standby mode

- 1) When the phone is in standby mode, view the Caller ID message (see "Viewing the Caller ID List" on page 45).
- 2) Press **talk/flash** or **speaker**. The displayed phone number dials automatically.

```
10/12 11:20AM
Jane Smith
214-555-1234
```

From Talk mode

- 1) Press **talk/flash** or **speaker**.
- 2) View the Caller ID message you want to dial (see "Viewing the Caller ID List" on page 45).
- 3) Press **select**/. The displayed phone number will be dialed.

Long Distance calls and Area Code Setting/Cancellation

While the present Caller ID information is displayed, pressing ***/tone/←** will place or remove the prefix "1" in the display to set the call for a long distance call, or pressing **#/→** will set or cancel an area code (see page 25).

Storing Caller ID messages in the Phonebook

Messages shown in the Caller ID list can be stored in the phonebook. The phone number and name of the party on the Caller ID list can be stored in memory.

- 1) When the phone is in standby mode, view the Caller ID message to be stored. Then press **select**/. **Store/Edit Name** appears.
- 2) To complete the setting, follow the steps 4-8 in "Storing Phone Numbers, Names, Distinctive Rings, and Speed dial" on page 36.



- You cannot make a call from the Caller ID list if your phone is connected to a private branch exchange (PBX).
- When a long distance call has been set, 1 appears in the display.
- If a call comes in via a telephone system that does not offer Caller ID service, no information is stored.
- If the Caller ID message was received as a private/unknown number, or the message does not have the number, you cannot store the message in the Phonebook. If it was received as private/unknown name, the message will be stored as <No Name>.
- Even if the 100 memory locations are full, the message will be stored in the Phonebook. However, the message will be erased from the Caller ID list.



- To activate features, select **CW On/CWDX On** in the CIDCW option. See page 25.
- You can also answer a waiting call immediately by pressing **talk/flash**, the first caller will be placed on hold. To return to the original caller, press **talk/flash** again.
- If you don't press a key within 30 seconds while in the operation, the phone goes back to the original call.

Call Waiting Deluxe Features

Your phone gives you new options for call waiting. At the touch of a button, you can place the caller on hold, send them to your voice mail service or conference them into your current call. You may be required to subscribe to Call Waiting and Call Waiting Deluxe to use these features. Not all features are available in all areas. Check with your local telephone company for details.

- 1) When you receive a Call Waiting call, press **menu/del** for a list of options.
- 2) Press **ring/vol/^** or **ring/vol/v** to select **CW Deluxe**, and then press **select/☒**.
- 3) Press **ring/vol/^** or **ring/vol/v** or the number keypad (**1-7**) to select an option.

For example:

press **ring/vol/v** 4 times

press **ring/vol/v** 2 times

1▶ Ask to Hold	3 Forward Call	5 Conference
2 Tell Busy	4 Answer/Drop 1	6 Drop First
3 Forward Call	5▶ Conference	7▶ Drop Last

- 3) Press **select/☒**. A confirmation screen will appear, and returns back to the call.

Your phone is pre-programmed with seven call waiting options. You may select to ask the calling party to hold, send them a busy message, forward them to your voice mail, or answer and drop the first caller. You may also select to conference them into the current call or, at any time, choose to drop the first or drop the last caller. Check with your local telephone company for a full list of options.

Expanding Your Phone

4 Multi-Handset Expandability

Your phone supports up to 4 handsets (including the handset(s) supplied with your phone). You can now place a fully-featured cordless handset anywhere AC power is available to connect the handset charger.

Up to 2 handsets can be used for an outside and/or intercom call.

For example, the phone permits 3-way conferencing (2 handsets and an outside line).

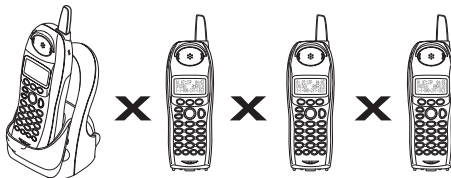

- To use the DCX640, register it to the original base.
- Save this manual for detailed operation.
- All of the handsets ring when a call is received.

IMPORTANT:

- If you purchase a DCX640 extra handset, please register the handset to the original/main base before use. The DCX640 will not operate until it is registered.
- If you change a Global setting in one handset, you change that particular setting for all registered handsets. All other settings (not included under Global Setup), must be set separately through each handset.

Connecting the Charger

- 1) Connect the AC adapter to the **DC IN 9V** jack and to a standard 120V AC wall outlet.
- 2) Set the charger on a desk or tabletop, and place the handset in the charger with the keypad facing forward. (See "B. Install the rechargeable battery pack into the handset" on page 12).

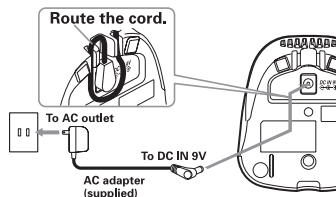

- Charge the handset battery pack for at least 15-20 hours before using your new cordless telephone for the first time.



note

- An extra handset can be registered when the main base is in standby mode.
- **Standby Mode** - The handset is not in use and *talk/flash* has not been pressed.

Register the Handset to the Base

If you purchase an extra handset, you need to register the handset to the base before use. Only one handset can be registered at a time.

The handset ID for the supplied handset(s) was assigned at the factory, which has #1 or #2 in the display (#2 for models that have two handsets in packaging). When you register additional handset to the base, the handset ID will be assigned.

Place handset
on main base
to register

- 1) Before registering the extra handset, the battery pack must be charged for 15-20 hours.
- 2) Place the extra handset in the main base unit to begin registration.
- 3) While the handset is registering, Handset Registering will appear in the LCD. When Registration Complete is displayed, the handset has been registered to the base. If Registration Failed appears, please try these steps again.

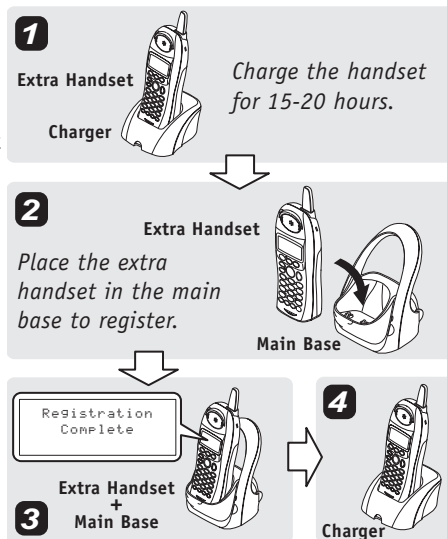

Using the DirectLink Mode

To use this feature, you must enter the two handsets into the DirectLink mode first.

To enter the DirectLink mode, see page 21.

DirectLink Call

- 1) When the phone is in the DirectLink standby mode, press **talk/flash** (example of DirectLink from handset #1).
- 2) Select the handset to which you wish to DirectLink with by pressing the number keys (1-4). Your handset will then page the other handset.
- 3) On the receiving handset, press **talk/flash**, or if Any Key Answer is on, press any number key, ***/tone/←**, or **#/→**.
- 4) When you finish your conversation, press **end** on either handset. Return the handset to the cradle, or press **menu/del**, and then **select/☒** to return to normal standby mode (canceling DirectLink mode).

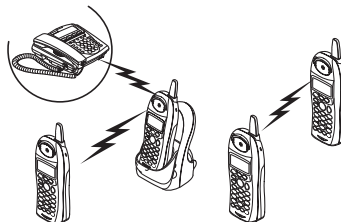

```
SUN 12:00A  █
Handset #1
DirectLink Mode
```

```
To DirectLink  █
a handset
press [1-4]
```

```
DirectLink  █
← Handset #1
```



Two handsets can be in Direct Link mode while other handsets are in use.

Room Monitor

This feature allows you to monitor sounds in another room. To use this feature, place the handset in the desired room to monitor (act as a remote mic), and place the other near the listener (remote speaker). For instruction, see "Using the Room Monitor" on page 22.



- If the party is busy or out of range, the handset returns to standby mode.
- If any of the following occurs while selecting the other handset, the operation will be canceled.
 - Press **talk/flash** or **speaker**.
 - Receive an outside/intercom call or page.
- When the party does not answer within one minute, the operation is canceled.
- **Standby Mode** - The handset is not in use and **talk/flash** has not been pressed.

3-Way Conferencing

The phone permits 3-way conversations between 2 handsets, and an outside line.

- 1) During a call, press **talk/flash** on another handset to initiate the 3-way conversation.
- 2) To remove either caller from your conversation, press **end** key on either handset.
The other handset will still be connected to the call.

Intercom/Call Transfer Feature

If you have one or more extra handsets, you can enjoy an intercom call between handsets. Also, you can place an outside call on hold and transfer the call to another handset.

Intercom

- 1) Press **hold/transfer/int'com** in standby mode.
- 2) Select the handset you want to talk with from the selection list within 30 seconds. To select the handset, press **ring/vol/∧** or **ring/vol/∨** and then press **select/☒**.
If you select **All**, all handsets will be paged.
An intercom tone sounds.
- 3) On the receiving handset, to answer the call, press **talk/flash** or **hold/transfer/int'com**.
If you turn AutoTalk on, pick up the handset from the cradle. If Anykey Answer is on, press any number key, ***/tone/←** or **#/→**.
- 4) To finish the intercom call, press **end** on either handset.

To intercom	
▶ Handset	#2
Handset	#3

Call Transfer Feature

- 1) During a call, press **hold/transfer/int'com**.
- 2) Select a handset to transfer the call within 10 seconds. (Refer to step 2 in the intercom section on page 52). The call will automatically be placed on hold, and an intercom tone sounds.
To cancel the transfer, press **talk/flash** or **speaker** on the initiating handset.
- 3) On the receiving handset, to answer the page, press **talk/flash** or **hold/transfer/int'com**. If you turn AutoTalk on, pick up the handset from the cradle. If Anykey Answer is On, press any number key, ***/tone/←**, or **#/→**. The intercom mode is activated, but the caller is still on hold.
- 4) To transfer the call, press **end** on the initiating handset, and press **talk/flash** on the receiving handset.

Hold, to transfer	
▶ Handset	#2
Handset	#3

Replacing the Base

If the base unit is replaced with a different base from this same series of cordless models, you must clear handset (s) and base identification numbers. To do this, select "System Reset" from handsets display menu option list (see page 27 for guidance).



For model number verification, contact Uniden Customer Service or visit our website
www.uniden.com

Changing the Digital Security Code

The digital security code is an identification code used to connect the handset and the base unit. Normally, setting the code is not necessary. In the rare situation that you suspect another cordless telephone is using the same security code, you can change the code.

To change the digital security code:

1. Perform the "System Reset" menu options ("De-register the Handset" and "Replacing the Base Setting") for all the handsets you have (see page 27).

2. To register all the handsets do the following steps:

1) Place a handset, one at a time in the base.

2) Registration starts automatically.

While registering Handset Registering appears in the display.

3) When the registration is complete, Registration Complete appears in the display.

4) Repeat steps 1 - 3 for another handsets.

If the registration fails, Registration Failed appears in the display. Try the steps above again.

Installing the Beltclip

To attach the beltclip

Insert the beltclip into the holes on each side of the handset.

Press down until it clicks.

To remove the beltclip

Pull either side of the beltclip to release the tabs from the holes.

Headset Installation

Your phone may be used with an optional headset, the Uniden HS910. To use this feature, insert the headset plug into the headset jack. Your phone is ready for hands-free conversations (headset may be purchased by calling the Uniden Parts Department or visiting the web site. See page 1).

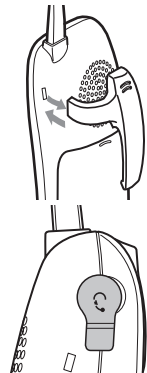

Note on Power Sources

Battery replacement and handling

When the operating time becomes short, even after a battery is recharged, please replace the battery. With normal usage, your battery should last about one year. Please contact your place of purchase or the Uniden Parts Department for a replacement battery.

Warning

To avoid the risk of personal injury or property damage from fire or electrical shock, only use the Uniden battery model and Uniden adapter model specifically designated for this product.

Power Failure

During the period that the power is off, you will not be able to make or receive calls with the telephone.

Caution

- Use only the specified Uniden battery pack (BT-446).
- Do not remove the batteries from the handset to charge them.
- Never throw the battery into a fire, disassemble them, or heat them.
- Do not remove or damage the battery casing.

Maintenance

To maintain a good charge, it is important to clean the charging contacts on both the handset and the base unit once a month. Using water only, dampen a cloth to clean the charging contacts. Then make sure to go back over the charging contacts with a dry cloth.

Caution

Do not use paint thinner, benzene, alcohol, or other chemical products. Doing so may discolor the surface of the telephone and damage the finish.

General Information

The phone complies with FCC Parts 15 and 68. Operating temperature: 0 °C to +50 °C (+32 °F to +122 °F)

AC Adapter Information

AC Adapter part number:	AD-800 for the base	AD-310 for the charger (2 handsets included model only)
Input Voltage:	120 AC 60Hz	120V AC 60Hz
Output Voltage:	9V DC 350mA	9V DC 210mA

Battery Information

Battery part number:	BT-446
Capacity:	800mAh, 3.6V



- To avoid damage to the phone use only Uniden AD-800 and BT-446 with your phone.
- If the handset is left off of the base, the actual Talk mode duration will be reduced respective to the amount of time the handset is off the base.

Recharge your phone on a regular basis by returning the handset to the base after each phone call. When the operating time becomes short, even after the battery is recharged, please replace the battery. With normal usage, the battery should last about one year.

A replacement Uniden adapter or battery may be purchased by contacting the Uniden Parts Department (800) 554-3988 or www.uniden.com. Hours are from 8:00 a.m. to 5:00 p.m. Central Time, Monday through Friday.

Specifications, features, and availability of optional accessories are all subject to change without prior notice.

Troubleshooting

If your phone is not performing to your expectations, please try these simple steps first.

Symptom	Suggestion
The charge LED won't illuminate when the handset is placed in the cradle.	<ul style="list-style-type: none"> • Make sure the AC adapter is plugged into the base (or the charger (for DCT646-2 only)), and wall outlet. • Make sure the handset is properly seated in the cradle. • Make sure the charging contacts on the handset and the base (or the charger (for DCT646-2 only)) are clean.
The audio sounds weak.	<ul style="list-style-type: none"> • Move the handset and/or base to a different location away from and/or scratchy metal objects or appliances and try again. • Make sure that you are not too far from the base.
Can't make or receive calls.	<ul style="list-style-type: none"> • Check both ends of the base telephone line cord. • Make sure the AC adapter is plugged into the base and wall outlet. • Disconnect the AC adapter for a few minutes, and then reconnect it. • Remove the base ID (see "Replacing the Base Setting" on page 27) and register the handset (see "Register the Handset to the Base" on page 50). • Make sure that you are not too far from the base. • If an outside call is already established, you can not be able to make another outside call.
The handset doesn't ring or receive a page.	<ul style="list-style-type: none"> • Charge the batteries in the handset for 15-20 hours by placing the handset on the base or charging cradle. • The handset may be too far away from the base unit. • Place the base unit away from appliances or metal objects. • Remove the base ID (see "Replacing the Base Setting" on page 27) and register the handset (see "Register the Handset to the Base" on page 50).
Unavailable appears in the display.	<ul style="list-style-type: none"> • Make sure that another handset(s) or the base is not in use, and try the phone again. • Make sure that you are not too far from the base.

Symptom	Suggestion
Severe noise interference.	<ul style="list-style-type: none"> • Keep the handset away from microwave ovens, computers, remote control toys, wireless microphones, alarm systems, intercoms, room monitors, fluorescent lights, and electrical appliances. • Move to another location or turn off the source of interference.
The Caller ID does not display.	<ul style="list-style-type: none"> • The handset was picked up before the second ring. • The call was placed through a switchboard. • Call your local telephone company to verify your Caller ID service is current.
Voice Message Indication does not work.	<ul style="list-style-type: none"> • Contact your local telephone company to make sure that your telephone receives FSK or SDT message signaling.
You cannot register the handset at the base.	<ul style="list-style-type: none"> • Charge the battery pack for 15-20 hours. • Remove the base ID (see "Replacing the Base Setting" on page 27) and register the handset (see "Register the Handset to the Base" on page 50).
The handset doesn't communicate with the other handsets.	<ul style="list-style-type: none"> • Remove the base ID (see "Replacing the Base Setting" on page 27) and register the handset (see "Register the Handset to the Base" on page 50). • Make sure that you have registered all handsets.
An extra handset can't join the conversation.	<ul style="list-style-type: none"> • Make sure there are not 2 handsets already using the 3-way conference feature.
You cannot make an intercom call with another handset.	<ul style="list-style-type: none"> • Make sure that the receiving handset is not in use.
If you still have a problem.	<ul style="list-style-type: none"> • Call our customer hotline at 1-800-297-1023.

Liquid Damage

Moisture and liquid can damage your cordless phone. In case of accidental submersion, please read the following steps.

Case	Action
If the handset or base is exposed to moisture or liquid, but only affects the exterior plastic housing.	Wipe off the liquid, and use as normal.
If moisture or liquid has entered the plastic-housing (i.e. liquid can be heard in the phone or liquid has entered the handset battery compartment or vent openings on the base).	<p>Handset:</p> <ol style="list-style-type: none"> 1) Remove the battery cover and leave it off for ventilation. 2) Remove the battery pack by disconnecting. 3) Leave the battery cover off and the battery pack disconnected for at least 3 days. 4) Once the handset is completely dry, reconnect the battery pack and the battery cover. 5) Recharge the handset's battery pack for 20 hours before using again. <p>Base:</p> <ol style="list-style-type: none"> 1) Disconnect the AC adapter from the base unit, cutting off electrical power. 2) Disconnect the telephone cord from the base unit. 3) Let dry for at least 3 days. <p>IMPORTANT: You must unplug the telephone line while recharging the battery pack to avoid charge interruption.</p> <p>CAUTION: DO NOT use a microwave oven to speed up the drying process. This will cause permanent damage to the handset, base and the microwave oven.</p> <p>After following these steps, if your cordless telephone does not work, please send to:</p> <p style="text-align: center;">Uniden America Corporation Parts and Service Division 4700 Amon Carter Blvd. Ft. Worth TX 76155 1-800-554-3988. Monday through Friday 8 a.m. to 5 p.m. CST</p>

Precautions!

Before you read anything else, please observe the following:

Warning!

Uniden America Corporation DOES NOT represent this unit to be waterproof. To reduce the risk of fire, electrical shock, or damage to the unit, DO NOT expose this unit to rain or moisture.

Rechargeable Nickel-Metal-Hydride Battery Warning

- This equipment contains a rechargeable Nickel-Metal-Hydride battery.
- Nickel is a chemical known to state of California to cause cancer.
- The rechargeable Nickel-Metal-Hydride battery contained in this equipment may explode if disposed of in a fire.
- Do not short-circuit the battery.
- Do not charge the rechargeable Nickel-Metal-Hydride battery used in this equipment in any charger other than the one designed to charge this battery as specified in the owner's manual. Using another charger may damage the battery or cause the battery to explode.

Rechargeable Nickel-Metal-Hydride Batteries Must Be Recycled or Disposed of Properly



The exclamation point within an equilateral triangle is intended to alert the user to the presence of important operating and maintenance (servicing) instructions in the literature accompanying the appliance.

Uniden works to reduce lead content in our PVC coated cords in our products and accessories.

Warning!

The cords on this product and/or accessories contain lead, a chemical known to the State of California to cause birth defects or other reproductive harm. **Wash hands after handling.**

Important Safety Instructions

When using your telephone equipment, these basic safety precautions should always be followed to reduce the risk of fire, electrical shock, and injury to persons:

1. Read and understand all instructions.
2. Follow all warnings and instructions marked on the product.
3. Unplug this product from the wall outlet before cleaning. Use a dry cloth for cleaning without liquid or aerosol cleaners.
4. Do not use this product near water; for example, near a bathtub, wash bowl, kitchen sink or laundry tub, in a wet basement, or near a swimming pool.
5. Do not place this product on an unstable cart, stand, or table. The telephone may fall, causing serious damage to the unit.
6. Slots and openings in the cabinet and the back or bottom are provided for ventilation. To protect the product from overheating, these openings must not be blocked or covered. This product should never be placed near or over a radiator or heat register. This product should not be placed in a built-in installation unless proper ventilation is provided.
7. This product should be operated only from the type of power source indicated on the marking label. If you are not sure of the type of power supply to your home, consult your dealer or local power company.
8. Do not allow anything to rest on the power cord. Do not locate this product where the cord will be damaged by persons walking on it.
9. Do not overload wall outlets and extension cords, as this can result in the risk of fire or electrical shock.
10. Never push objects of any kind into this product through cabinet slots, as they may touch dangerous voltage points or short out parts that could result in a risk of fire or electric shock. Never spill liquid of any kind on the product.
11. To reduce the risk of electric shock, do not disassemble this product. Take it to qualified service personnel when service or repair work is required. Opening or removing covers may expose you to dangerous voltages or other risks. Incorrect reassembly can cause electric shock when the appliance is subsequently used.
12. Unplug this product from the wall outlet and refer servicing to qualified service personnel under the following conditions:
 - A. When the power supply cord is damaged or frayed.
 - B. If liquid has been spilled into the product.
 - C. If the product has been exposed to rain or water.
 - D. If the product does not operate normally when following the operating instructions. (Adjust only those controls that are covered by the operating instructions. Improper adjustment of other controls may result in damage and will often require extensive repair work by a qualified technician.)
 - E. If the product has been dropped or the cabinet has been damaged.
 - F. If the product exhibits a distinct change in performance.
13. Do not use the telephone to report a gas leak in the vicinity of the leak.

Additional Battery Safety Precautions

Caution! To reduce the risk of fire or injury to persons by the battery, read and follow these instructions:

1. Use only the Uniden battery pack specified in the owner's manual.
2. Do not dispose of the battery pack in a fire. The cell may explode. Check the Nickel Metal Hydride battery disposal package insert for disposal instructions.
3. Do not open or mutilate the battery pack. Released electrolyte is corrosive and may cause damage to the eyes or skin. It may be toxic if swallowed.
4. Exercise care in handling the battery in order not to short the battery with conducting materials such as rings, bracelets, and keys. The battery or conductor may overheat and cause burns.
5. Charge the battery pack provided with or identified for use with this product only in accordance with the instructions and limitations specified in the owners manual provided for this product.
6. Observe proper polarity orientation between the battery pack and battery charger.

SAVE THESE INSTRUCTIONS!

Important Electrical Considerations

Unplug all electrical appliances when you know an electrical storm is approaching. Lightning can pass through your household wiring and damage any device connected to it. This phone is no exception.

The FCC Wants You To Know

Changes or modifications to this product not expressly approved by Uniden, or operation of this product in any way other than as detailed by the owner's manual, could void your authority to operate this product. Your telephone complies with Part 68 of FCC Rules. You must, upon request, provide the FCC registration number and the REN to your telephone company. Both numbers are on the base unit.

Note: You must not connect your phone to:

- coin-operated systems
- most electronic key telephone systems

This device complies with part 15 of the FCC rules. Operation is subject to the following two conditions: (1) This device may not cause harmful interference, and (2) This device must accept any interference received, including interference that may cause undesired operation. Privacy of communications, may not be ensured when using this phone.

Range

Your new phone is designed to achieve the maximum possible range by transmitting and receiving according to the highest specifications set forth by the FCC. We have rated this phone to operate at a maximum distance with the qualification that the range depends upon the environment in which the telephone is used. Many factors limit range, and it would be impossible to include all the variables in our rating. The Maximum Range rating of this phone is meant to be used as a means of comparison against other range claims.

Telephone Line Problems

The FCC has granted the telephone company the right to disconnect service in the event that your phone causes problems on the telephone line. Also, the telephone company may make changes in facilities and services which may affect the operation of your unit. However, your telephone company must give adequate notice in writing prior to such actions to allow you time for making necessary arrangements to continue uninterrupted service. If you are having trouble with your telephone service, you must first disconnect your phone to determine if it is the cause of your problem. If you determine that it is the cause, you must leave it disconnected until the trouble has been corrected.

Radio Interference

Radio interference may occasionally cause buzzing and humming in your cordless handset, or clicking noises in the base. This interference is caused by external sources such as TV, refrigerator, vacuum cleaner, fluorescent lighting, or electrical storm. Your unit is NOT DEFECTIVE. If these noises continue and are too distracting, please check around your home to see what appliances may be causing the problem. In addition, we recommend that the base not be plugged into a circuit that also powers a major appliance because of the potential for interference. Be certain that the antenna on the unit is fully extended when needed.

In the unlikely event that you consistently hear other voices or distracting transmissions on your phone, you may be receiving radio signals from another cordless telephone or other source of interference. If you cannot eliminate this type of interference, you need to change to a different channel.

Finally, it should be noted that some cordless telephones operate at frequencies that may cause interference to nearby TVs and VCRs. To minimize or prevent such interference, the base of the cordless telephone should not be placed near or on top of a TV or VCR. If interference is experienced, moving the cordless telephone farther away from the TV or VCR will often reduce or eliminate the interference.

More than One Cordless Telephone

If you want to use more than one cordless telephone in your home, they must operate on different channels. Press the channel key to select a channel that provides the clearest communication.

Cordless Telephone Privacy

Cordless telephones are radio devices. Communications between the handset and base of your cordless telephone are accomplished by means of radio waves which are broadcast over the open airways. Because of the inherent physical properties of radio waves, your communications can be received by radio receiving devices other than your own cordless telephone unit. Consequently, any communications using your cordless telephone may not be private.

Installation Considerations

Selecting a Location

Before choosing a location for your new phone, there are some important guidelines you should consider:

- The location should be close to both a phone jack and continuous power outlet. (A continuous power outlet is an AC outlet which does not have a switch to interrupt its power.)
- Keep the base and handset away from sources of electrical noise such as motors or fluorescent lighting.
- Be sure there is sufficient space to fully extend the base antenna.
- The base can be placed on a desk or tabletop or mounted on a standard telephone wall plate.
- You should charge your new phone for 15-20 hours before completing the installation or using the handset.

Telephone Line Outlets

There are two types of phone outlets:

Modular Jack

Most phone equipment available now uses modular jacks. Phone cords are fitted with a molded plastic connector which plugs into this type of jack. If you do not have modular phone jacks, contact your local telephone company for information about their installation.

Hardwired Jack

Some equipment is wired directly to a phone jack, and these types of installations require a modular jack converter. This type of installation is not difficult; however, you should contact your Uniden telephone dealer or a telephone supply store for advice about the proper adapter or converter for your particular situation.

Connecting the Telephone Cords

Consider these safety guidelines before connecting the telephone cords: Caution!

- *Never install telephone wiring during a lightning storm.*
- *Never touch uninsulated telephone wires or terminals unless the telephone line has been disconnected.*
- *Use caution when installing or modifying telephone lines.*

Applying Power to the Base

This phone requires an AC outlet, without a switch to interrupt power, and the included AC adapter. To relieve strain on the DC plug when the phone is placed on a desk or table, wrap the power cord around the strain relief notch on the bottom of the base.

NOTE: Place the power cord so that it does not create a trip hazard, or where it could become chafed and create a fire or other electrical hazards.

One Year Limited Warranty

Important: Evidence of original purchase is required for warranty service. WARRANTY: UNIDEN AMERICA CORPORATION ("Uniden") ELEMENTS OF WARRANTY: Uniden warrants, for one year, to the original retail owner, this Uniden Product to be free from defects in materials and craftsmanship with only the limitations or exclusions set out below.

WARRANTY DURATION: This warranty to the original user shall terminate and be of no further effect 12 months after the date of original retail sale. The warranty is invalid if the Product is (A) damaged or not maintained as reasonable or necessary, (B) modified, altered, or used as part of any conversion kits, subassemblies, or any configurations not sold by Uniden, (C) improperly installed, (D) serviced or repaired by someone other than an authorized Uniden service center for a defect or malfunction covered by this warranty, (E) used in any conjunction with equipment or parts or as part of any system not manufactured by Uniden, or (F) installed or programmed by anyone other than as detailed by the owner's manual for this product.

STATEMENT OF REMEDY: In the event that the product does not conform to this warranty at any time while this warranty is in effect, warrantor will either, at its option, repair or replace the defective unit and return it to you without charge for parts, service, or any other cost (except shipping and handling) incurred by warrantor or its representatives in connection with the performance of this warranty. Warrantor, at its option, may replace the unit with a new or refurbished unit. THE LIMITED WARRANTY SET FORTH ABOVE IS THE SOLE AND ENTIRE WARRANTY PERTAINING TO THE PRODUCT AND IS IN LIEU OF AND EXCLUDES ALL OTHER WARRANTIES OF ANY NATURE WHATSOEVER, WHETHER EXPRESS, IMPLIED OR ARISING BY OPERATION OF LAW, INCLUDING, BUT NOT LIMITED TO ANY IMPLIED WARRANTIES OF MERCHANTABILITY OR FITNESS FOR A PARTICULAR PURPOSE. THIS WARRANTY DOES NOT COVER OR PROVIDE FOR THE REIMBURSEMENT OR PAYMENT OF INCIDENTAL OR CONSEQUENTIAL DAMAGES. Some states do not allow this exclusion or limitation of incidental or consequential damages so the above limitation or exclusion may not apply to you.

LEGAL REMEDIES: This warranty gives you specific legal rights, and you may also have other rights which vary from state to state. This warranty is void outside the United States of America and Canada.

PROCEDURE FOR OBTAINING PERFORMANCE OF WARRANTY: If, after following the instructions in the owner's manual you are certain that the Product is defective, pack the Product carefully (preferably in its original packaging). The Product should include all parts and accessories originally packaged with the Product. Include evidence of original purchase and a note describing the defect that has caused you to return it. The Product should be shipped freight prepaid, by traceable means, to warrantor at:

Uniden America Corporation
Parts and Service Division
4700 Amon Carter Blvd.
Fort Worth, TX 76155

(800) 297-1023, 8 a.m. to 5 p.m. CST, Monday through Friday

I.C. Notice

TERMINAL EQUIPMENT

NOTICE: This equipment meets the applicable Industry Canada Terminal Equipment Technical Specifications. This is confirmed by the registration number. The abbreviation, IC, before the registration number signifies that registration was performed based on a Declaration of Conformity indicating that Industry Canada technical specifications were met. It does not imply that Industry Canada approved the equipment.

NOTICE: The Ringer Equivalence Number (REN) for this terminal equipment is marked on the equipment itself. The REN assigned to each terminal equipment provides an indication of the maximum number of terminals allowed to be connected to a telephone interface. The termination on an interface may consist of any combination of devices subject only to the requirement that the sum of the Ringer Equivalence Numbers of all the devices does not exceed five.

RADIO EQUIPMENT

The term "IC:" before the radio certification number only signifies that Industry Canada technical specifications were met.

Operation is subject to the following two conditions: (1) this device may not cause interference, and (2) this device must accept any interference, including interference that may cause undesired operation of the device. "Privacy of communications may not be ensured when using this telephone".

Index

0 - 9

- 3-way conferencing 52
- 20 ring options 23

A

- Anykey answer. 24
- Area code 25
- AutoTalk. 23

B

- Banner. 24
- Battery
 - Preparing and charging 12
 - Replacement and handling 55
- Beltclip 54

C

- Caller ID
 - Caller ID service 44
 - Calling 47
 - Call Waiting 34
 - Deleting 46
 - Setting 47
 - Storing 47
 - Using 47
 - Viewing. 45
- Call transfer feature 53
- Chain dialing. 43
- CIDCW 44
- CWDX 48
- Clarity Booster. 33
- Clock 25
- Copy phonebook. 26

www.uniden.com

D

- Day & Time 25
- Deluxe Call Waiting features 48
- De-register the handset 27
- Dialing mode 15
- Digital security code 54
- Direct link 21
- Distinctive ringer 23

E, F, G, H

- Earpiece volume 31
- Edit voice mail. 19
- Expanding your phone. 49
- General information 56
- Global setup 20
- Hands-free conversation 28
- Handset setup 20
- Headset installation 54

I, J, K, L

- I.C. Notice. 62
- Important safety instructions 60
- Intercom. 52
- Key touch tone. 24
- Language 24

M, N, O

- Maintenance 55
- Making a call 28
- Mute 32
- New message LED 35

P, Q

- Package contents 1
- Phonebook
 - Editing 42
 - Erasing 42
 - Making calls 41
 - Storing 36
 - Viewing 40
- Precautions 60
- Privacy Mode 33

R

- Receiving a call 28
- Redialing a call. 30
- Register the handset 50
- Replacing Base 53
- Ringer volume 31
- Room Monitor. 22

S

- Setting up
 - base unit 14
 - extra handset 49
 - handset 19
- Speed dialing 41
- System reset 20

T, U, V, W, X, Y, Z

- Transferring a call. 52
- Troubleshooting 57
- Voice Mail 35
 - Voice Mail Tone. 27
 - Programming 22
- Warranty 61

Memory List

	Name	Phone No.		Name	Phone No.		Name	Phone No.
1			36			71		
2			37			72		
3			38			73		
4			39			74		
5			40			75		
6			41			76		
7			42			77		
8			43			78		
9			44			79		
10			45			80		
11			46			81		
12			47			82		
13			48			83		
14			49			84		
15			50			85		
16			51			86		
17			52			87		
18			53			88		
19			54			89		
20			55			90		
21			56			91		
22			57			92		
23			58			93		
24			59			94		
25			60			95		
26			61			96		
27			62			97		
28			63			98		
29			64			99		
30			65			100		
31			66					
32			67					
33			68					
34			69					
35			70					

At Uniden, we'll take care of you!

If you need any assistance with this product, please call our Customer Hotline at

1-800-297-1023

PLEASE DO NOT RETURN THIS PRODUCT TO THE PLACE OF PURCHASE.

Our Uniden representatives will be happy to help you with any matters regarding the operation of this unit, available accessories, or any other related matters.

Thank you for purchasing a Uniden product.

Hours: M-F 8:00 AM to 5:00 PM CST.

www.uniden.com



For information on the accessibility features of this product, please call
1-800-874-9314 (V/TTY)

Uniden®

May be covered under one or more of the following U.S. patents:

4,523,058	4,595,795	4,797,916	5,381,460	5,426,690	5,434,905
5,491,745	5,493,605	5,533,010	5,574,727	5,581,598	5,650,790
5,660,269	5,661,780	5,663,981	5,671,248	5,696,471	5,717,312
5,732,355	5,754,407	5,758,289	5,768,345	5,787,356	5,794,152
5,801,466	5,825,161	5,864,619	5,893,034	5,912,968	5,915,227
5,929,598	5,930,720	5,960,358	5,987,330	6,044,281	6,070,082
6,125,277	6,253,088	6,314,278	6,418,209		

ADDITIONAL HANDSET & CHARGER

EXPAND YOUR SYSTEM!

DCX 640 HANDSET & CHARGER

Easily expand your cordless phone system by adding the DCX 640 Handset and Charger.*

The DCX 640 gives you the mobility you need to stay connected with friends and family. Place this handset and charger in any convenient location, no need for an extra phone jack!

Another innovation from Uniden, the company that brings you a world without wires.



* Operates with Cordless Systems: DCT 646 and DCT 646-2.

Uniden®

- Optional 2.4GHz Cordless Handset and Charging Cradle
- For use with Cordless Systems: DCT 646 and DCT 646-2.
- Digital Spread Spectrum
- Intercom or Call Transfer
- Caller ID/Call Waiting
- No Phone Jack Needed

MAXIMUM EXPANDABILITY:
4 Handsets per system

©2004 Uniden America Corporation, Fort Worth, Texas. Contains additional foreign articles. Custom manufactured in China.

AVAILABLE AT PARTICIPATING RETAIL STORES. www.Somanuals.com. All Manuals Search And Download.

UPZZ01317BA

Free Manuals Download Website

<http://myh66.com>

<http://usermanuals.us>

<http://www.somanuals.com>

<http://www.4manuals.cc>

<http://www.manual-lib.com>

<http://www.404manual.com>

<http://www.luxmanual.com>

<http://aubethermostatmanual.com>

Golf course search by state

<http://golfingnear.com>

Email search by domain

<http://emailbydomain.com>

Auto manuals search

<http://auto.somanuals.com>

TV manuals search

<http://tv.somanuals.com>