

Uniden®

**DECT 6035
DECT 6035 + 1
Series**

OWNER'S MANUAL

Table of Contents

Welcome	4	Insert 0.....	18
Terminology Used in this Manual.....	5	Expanding Your Phone	19
Manual Conventions.....	5	Adding Accessory Handsets.....	19
Product Overview	6	Using Multiple Bases.....	21
Features.....	6	Setting Up the Phonebook	22
Answering System Features.....	6	Creating Phonebook Entries.....	22
Parts of the Phone.....	7	Finding a Phonebook Entry.....	23
Using the Interface	9	Editing an Existing Phonebook Entry.....	24
Reading the Display.....	9	Storing Caller ID or Redial Numbers in the Phonebook.....	24
Using the Four-way Function Key.....	10	Deleting Phonebook Entries.....	24
Using the Handset Menus.....	10	Copying Phonebook Entries to Another Handset ..	25
Entering Text from Your Handset.....	11	Using the Voice Mail Service	26
Installing the Phone	12	Resetting the Voice Message Waiting Indicator.....	26
Choosing the Best Location.....	12	Customizing Your Phone	26
Installing the Battery.....	13	Changing the Handset Banner.....	26
Installing the Belt Clip.....	14	Selecting a Ring Tone (Handset only).....	27
Connecting the Base and Charging the Handset ..	14	Activating AutoTalk.....	27
Connecting to the Phone Line.....	15	Activating Any Key Answer.....	27
Wall Mounting the Base.....	16	Using Your Phone	28
Basic Setup	17	Making a Call from the Phonebook.....	29
Activating Personal Ring.....	17	Chain Dialing from the Phonebook.....	29
Activating the Key Touch Tone.....	17		
Name Tag.....	18		

Switching to the Handset Speakerphone During a Call	29
Using Caller ID, Call Waiting, and Redial Lists.....	30
Using the Caller ID List	30
Making a Call from a Caller ID Record	30
Deleting Caller ID Numbers	31
Using Call Waiting.....	31
Redialing a Number	31
Deleting a Redial Record.....	32
Adjusting the Ringer, Earpiece and Speaker Volume.....	32
Adjusting the Ringer Volume	32
Adjusting the Earpiece Volume	32
Adjusting the Speaker Volume.....	32
Adjusting the Audio Tone	33
Finding a Lost Handset.....	33
Using Hold, Conference and Transfer	33
Placing a Call on Hold	33
Conferencing	34
Transferring a Call	34
Using Special Features	35
Privacy Mode	35
Using the Intercom.....	35
Muting the Ringer (One call only)	36
Muting the Microphone	36

Line Mode Setup (Base only)	37
Installing the Optional Headset.....	37
Setting Up the Answering System	38
Using the Answering System Setup Menus.....	38
Recording a Personal Greeting	38
Selecting a Greeting	39
Deleting Your Personal Greeting	39
Setting the Number of Rings.....	40
Setting the Day & Time.....	40
Setting the Record Time (or Announce only).....	40
Activating the Message Alert	41
Activating Call Screening.....	41
Setting a Security Code or Personal Identification Number (PIN).....	41
Using the Answering System	42
Turning Your Answering System On and Off	42
Reviewing Messages.....	43
Screening Calls.....	44
Turning Off the Message Alert Tone.....	44
Operating the Answering System While You Are Away from Home	45
Maintenance.....	46
Specifications.....	46
Battery Replacement and Handling	46
Cleaning the Battery Contacts	47
Low Battery Alert	47



Battery Life.....	47
Power Failures.....	47
Troubleshooting	48
Resetting the Handset	48
Resetting the Handset Without the Base.....	49
Traveling Out of Range.....	49
Common Issues.....	50
Liquid Damage.....	52
Precautions!	53
Rechargeable Nickel-Metal-Hydride Battery Warning	53
Index	54
Remote Operation Card	56
One Year Limited Warranty.....	58



Welcome

Thank you for purchasing a Uniden Multi-Handset phone.

Note: Illustrations in this manual are used for explanation purposes. Some illustrations in this manual may differ from the actual unit.

Terminology Used in this Manual

Standby	The handset is not in use. If it is off the cradle, no line has been activated. No dial tone is present.
CID	Caller ID is available from your Telephone provider and is offered to users on a subscription basis. With this service, you will be able to see the incoming caller information such as name and phone number.
CID/CW or CIDCW	Caller ID with Call Waiting is available by subscription from your Telephone provider. With this service, you will be able to view incoming caller information while on a call with another user.
Base	The main part of the phone that connects to your phone line and lets you make and receive calls.
Charger	A cradle that comes with an accessory handset and charges the handset battery. It connects to power but does not connect to a phone line.
Accessory Handsets	Additional handsets that can register to the base, allowing you to add handsets without connecting another phone line. This base supports a total of six cordless handsets; see page 19 for Compatible Handsets.
Global Settings	This term relates to feature settings that will apply to all registered handsets and the base. These features are available by selecting "GLOBAL SETUP" in the handset menu. Only one handset can change global settings at a time, and you have to make sure the phone is not currently being used. If you have multiple bases, the different bases have each global settings; select the base before changing the global setting (see Selecting the Base on page 21).
Talk	A telephone line has been activated on the handset or base, enabling a dial tone.

Manual Conventions

This manual uses several different type styles to help you distinguish between different parts of the phone:

- Bold text with “[]” indicates a key or button on the phone
- ALL CAPITALS indicates text on the display, such as menu options, prompts, and confirmation messages
- lower case bold text indicates a status light on the phone
- ALL CAPITALS BOLD indicates a connection jack on the base or charger

Product Overview

Features

- 1.8GHz DECT6.0 Expandable System
- Expands up to 6 Handsets
- Integrated Digital Answering System
- Caller ID/Call Waiting
- Store 30 Caller ID Numbers
- Advanced Phonebook Features:
 - Store 70 Phonebook Entries
 - Alphabetical Search
 - Personalized Ring by Party
 - Transfer Single Listing or Entire Phonebook
- Speakerphone on Handset
- 7 Ringer Options on Handset (3 Tones/4 Melodies)
- Last 5 Number Redial
- Call Transfer
- Conferencing
- Intercom

Answering System Features

- Digital Tapeless Recording
- Up to 14 Minutes of Recording Time
- Call Screening
- Personal or Pre-recorded Outgoing Messages
- Day and Time Announcement
- Remote Message Retrieval
- Toll Saver
- Message Alert
- Records Up to 59 messages

Parts of the Phone

The following illustrations show you all of the different parts of your phone.

Handset

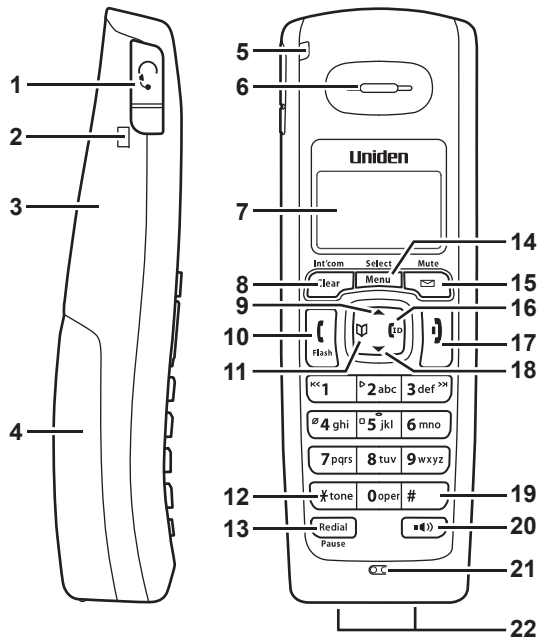

1. Headset jack cover
2. Belt clip hole
3. Speakerphone speaker and ringer
4. Handset battery compartment
5. **new message** LED
6. Handset earpiece
7. LCD display
8. **[Clear/Int'com]** key
9. **[▲]** key (up)
10. **[Flash]** key (talk/flash)
11. **[📖]** key (phonebook/left)
12. **[*/tone]** key
13. **[Redial/Pause]** key
14. **[Menu/Select]** key
15. **[📧/Mute]** key (messages/mute)
16. **[ID]** key (caller ID/right)
17. **[⏹]** key (end call)
18. **[▼]** key (down)
19. **[#]** key
20. **[🔊]** key (speaker)
21. Handset microphone
22. Handset charging contacts

Base

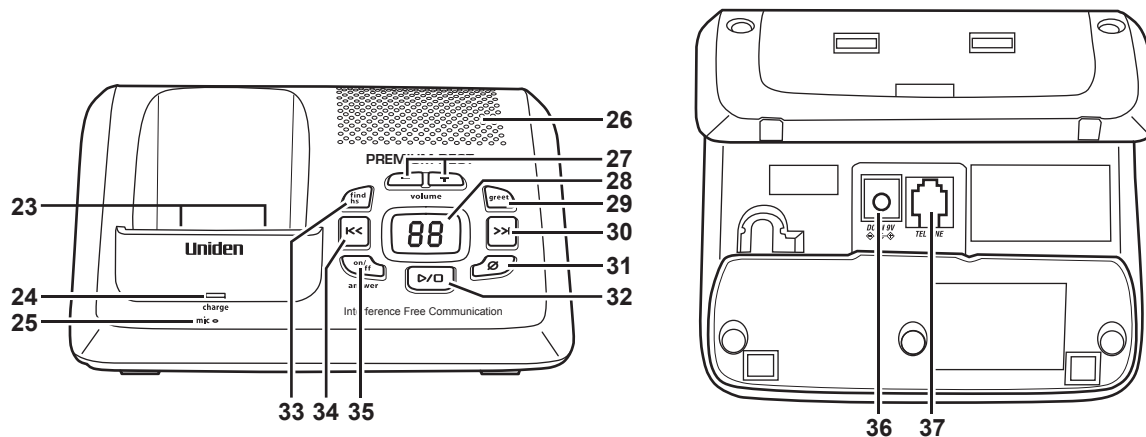







- 23. Base charging contacts
- 24. charge LED
- 25. Base microphone
- 26. Base speaker
- 27. [volume +/-] keys
- 28. **message counter** LED
- 29. [**greet**] key (record/select greeting)
- 30. [**>>>**] key (skip)
- 31. [**Ø**] key (delete)
- 32. [**D/□**] key (play/stop)
- 33. [**find hs**] key (find handset)
- 34. [**K<<**] key (repeat)
- 35. [**answer on/off**] key (answering system on/off)
- 36. **DC IN 9V** jack
- 37. **TEL LINE** jack

Using the Interface

Reading the Display

The handset display uses icons to tell you the status of your phone. The table below lists the icons and what they mean.

Icon	Status	Description
	Standby/Talk	The battery icon indicates the handset battery status: full, medium, low, and empty.
	Standby	The ringer off icon indicates that the ringer is turned off.
	Talk	The mute icon appears while the handset microphone is muted.
	Talk	The speaker icon appears when the handset speaker phone is in use.
	Talk	The privacy icon appears when the Privacy Mode is turned on.
	Standby	The voice mail icon appears when you have messages waiting in your voice mailbox.

The Standby Screen

When the phone is in standby, the handset display shows the following items:

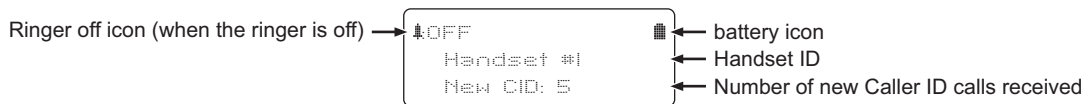

Using the Four-way Function Key

Your handset has a four-way function key that allows you to move the cursor or pointer on the display and access the most commonly used features at the touch of a button. By moving this key to the left, you open the phonebook. Move the key to the right to access Caller ID information. To use this four-way key, place your thumb over the key on the handset and move to the four positions to get the feel of how it moves and operates.

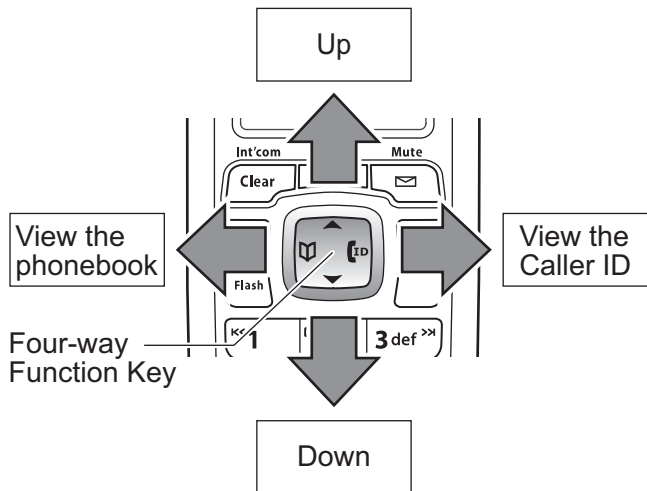

Using the Handset Menus

To open the menu, press **[Menu/Select]**. Highlight the option you want by pressing the four-way function key. This will move the cursor; the option currently highlighted has a triangle beside it. Activate the highlighted option by pressing **[Menu/Select]**. To go back to the previous screen, press **[left]** on the four-way function key. To exit the menu and return to standby, press **[*]**.

If you do not press a key within thirty seconds, the phone will time out and exit the menu. When setting the day and time, the time-out period is extended to two minutes.

Note: For ANSW. SETUP and GLOBAL SETUP menu options, make sure the line is not in use and the handsets are within range of the base.

Entering Text from Your Handset

You can use the number keypad on your handset to enter text by referring to the letters printed on each number key. When you press the number key in a text entry field, the phone displays the first letter printed on the number key. Press the number key twice to display the second letter and three times to display the third. Capital letters are displayed first, then lower case letters, and then the number on the key.

If two letters in a row use the same number key, enter the first letter, then use **[right]** on the four-way function key to move the cursor to the next position to enter the second letter.

For example, to enter the word "Movies":

- 1) Press **[6]** once to enter M.
- 2) Use **[right]** on the four-way function key to move the cursor to the right.
- 3) Press **[6]** six times to enter o.
- 4) Press **[8]** six times to enter v.
- 5) Press **[4]** six times to enter i.
- 6) Press **[3]** five times to enter e.
- 7) Press **[7]** eight times to enter s.
- 8) Press **[Menu/Select]** to end your text entry.

	Number of times key is pressed								
keys	1	2	3	4	5	6	7	8	9
1	I								
2 abc	A	B	C	a	b	c	2		
3 def	D	E	F	d	e	f	3		
4 ghi	G	H	I	g	h	i	4		
5 jkl	J	K	L	j	k	l	5		
6 mno	M	N	O	m	n	o	6		
7 pqrs	P	Q	R	p	q	r	s	7	
8 tuv	T	U	V	t	u	v	8		
9 wxyz	W	X	Y	Z	w	x	y	z	9
0 oper	&	<	>	<	>	/	(blank)	-	_
	.	,	=	?	!	@	'	"	*
	#	0							

If you make a mistake while entering a name, use **[right]** or **[left]** on the four-way function key to move the cursor to the incorrect character. Press **[Clear/Int'com]** to erase the wrong character, and then enter the correct character. To delete all characters, press and hold **[Clear/Int'com]**.

Note: When you enter the text, you can also use **[#]** to move the cursor to right and **[*/tone]** to move the cursor to left.

Installing the Phone

Choosing the Best Location

When choosing a location for your new phone, here are some important guidelines you should consider:

- The location should be close to both a phone jack and a continuous power outlet (one which is not connected to a switch).
- For optimum range and reception, place the base in an open area, as high as possible.
- If your home has wired alarm equipment connected to a phone line, be sure that installing the system does not disable your alarm equipment. If you have questions about what will disable alarm equipment, contact your telephone company or a qualified installer.

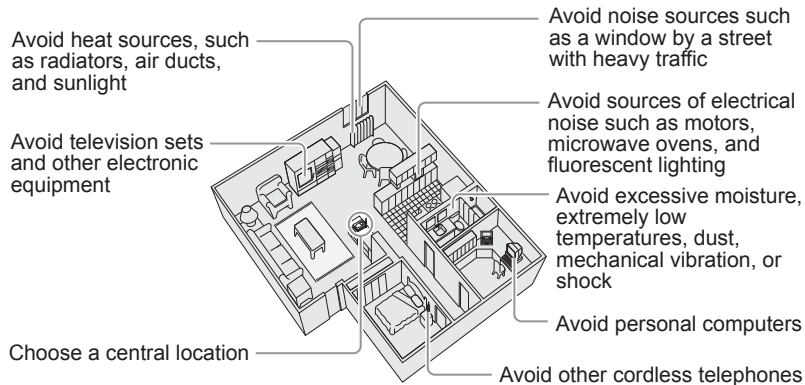

Note: For maximum range:

- Keep both the base and handset antennas free of obstruction.
- When the handset is not in use, place the handset in an upright position.
- Metal and reinforced concrete may affect cordless telephone performance.

Installing the Battery

Use only the Uniden BT-652 rechargeable battery pack supplied with your cordless telephone.

Follow the steps below to install the handset battery.

- 1) Press in on the handset battery case cover (use the finger indention for a better grip) and slide the cover downward to remove.
- 2) Plug the battery cable into the battery jack. Be sure to match the red and black wires to the label near the jack. The cable should snap into place. Gently pull on the battery cable. If the battery connector comes loose, try connecting again until the battery snaps into place.
- 3) Place the battery case cover back on the handset and slide it upwards until it clicks into place.

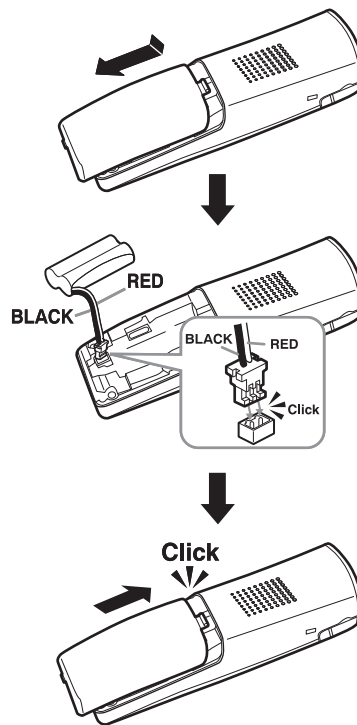

Installing the Belt Clip

Line up the holes on each side of the handset. To attach the belt clip, insert into the holes on each side of the handset. Press down until it clicks.

To remove the belt clip, pull either side of the belt clip to release the tabs from the holes.

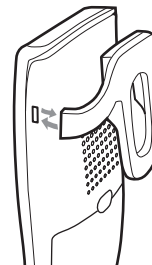

Connecting the Base and Charging the Handset

- 1) Route the AC adapter cord through the "LOOP" of base's back as shown.
- 2) Connect the AC adapter to the DC IN 9V jack.

CAUTION: To avoid risk of fire and shock, only use the Uniden AAD-041S AC adapter.

- 3) Connect the AC adapter to a standard 240V AC wall outlet. DO NOT use an AC outlet controlled by a wall switch.
- 4) Place the handset in the base with the LCD screen facing forward.
- 5) Make sure that the charge LED illuminates. If the LED does not illuminate, check to see that the AC adapter is plugged in and the handset makes good contact with the charging contacts.
- 6) Charge your handset at least 15 to 20 hours before plugging into the phone line.

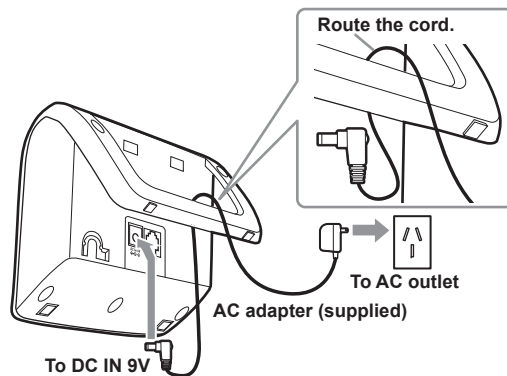

Connecting to the Phone Line

- 1) Once the battery pack is fully charged, route the telephone cord through the "LOOP" of base's back as shown, and connect the telephone cord to the TEL LINE jack.
- 2) Connect the telephone cord to a telephone wall jack.

Testing the Connection

Try making a call. If your call does not connect or you cannot get a dial tone, try the following steps:

- 1) Make sure the AC adapter cord is securely connected to the DC IN 9V jack and a standard power outlet.
- 2) Check to make sure the battery is fully charged. (If you don't see the "battery full" icon, check to make sure the battery is properly connected).

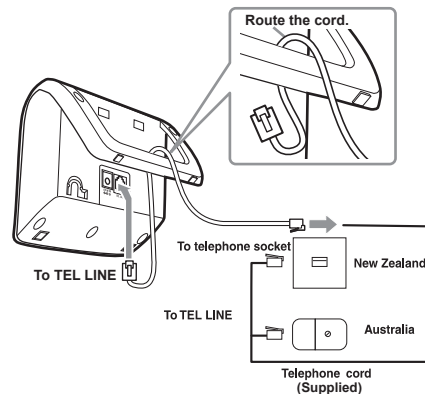

Wall Mounting the Base

This phone can be mounted on any standard wall plate.

- 1) Snap the wall mount adapter into the notches on the base's back.
- 2) Plug the AC adapter into the DC IN 9V jack.
- 3) Plug the AC adapter into a standard 240V AC wall outlet.
- 4) Plug the telephone cord into the TEL LINE jack.
- 5) Route the telephone cord through the hole of the wall mount adapter as shown.
- 6) Plug the telephone cord into the telephone wall jack.
- 7) Align the mounting slots on the base with the mounting posts on the wall. Then push in and down until the phone is firmly seated.

Notes:

- To mount the phone directly on the wall, insert two #10 screws (minimum length of 35 mm, not supplied) into the wall, 100 mm apart; leave the screw heads 3 mm away from the wall to allow room for mounting the phone. Be sure the wall is capable of supporting the weight of the phone, and use the proper type of anchoring device for the wall material. No need to route the telephone cord through the hole of the wall mount adapter when mounting directly on the wall.

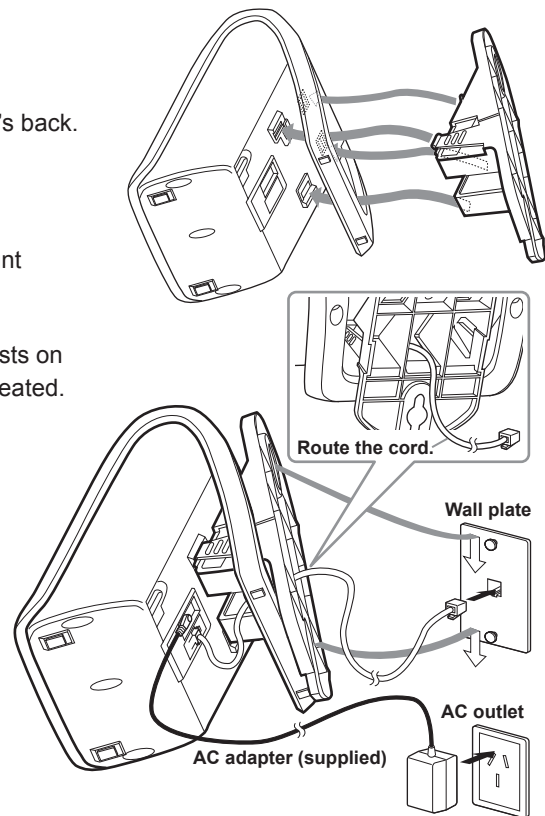

Basic Setup

Activating Personal Ring

You can assign special ringer tones to anyone in your phonebook. When your phone gets a call, it looks up the Caller ID information in your phonebook. If you've assigned a personal ringer to that number, the phone uses it so you know who is calling. To turn the personal ringing on or off, follow these steps:

- 1) Press **[Menu/Select]**. Select the HANDSET SETUP menu, and then the PERSONAL RING submenu.
- 2) Move the cursor to select ON or OFF.
- 3) Press **[Menu/Select]**. You will hear a confirmation tone.

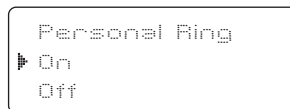

Activating the Key Touch Tone

Key Touch Tone is the tone your keypad makes when keys are pressed. You can turn this tone on or off.

- 1) Press **[Menu/Select]**. Select the HANDSET SETUP menu, and then the KEY TOUCH TONE submenu.
- 2) Move the cursor to select ON or OFF.
- 3) Press **[Menu/Select]**. You will hear a confirmation tone.

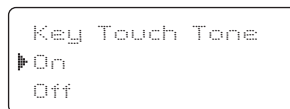

Name Tag

Name Tagging works with the caller display number from Caller ID. You will need to subscribe to the Caller ID feature with your phone company for Name Tagging to work.

When the phone rings, the received caller display number is compared to numbers stored in the phonebook. If there is a match then any name stored with the phonebook number will be displayed. To change the Name Tagging setting, follow the steps listed below.

- 1) Press **[Menu/Select]**. Select the GLOBAL SETUP menu, and then the NAME TAG submenu.
- 2) Move the cursor to select ON or OFF.
- 3) Press **[Menu/Select]**. You will hear a confirmation tone.

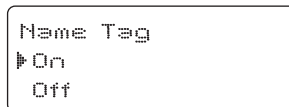

Insert 0

This feature adds “0” or “00” at the beginning of the number received from Caller ID. The default setting for New Zealand is ON. The default setting for Australia is OFF. To change the Name Tagging setting, follow the steps listed below.

- 1) Press **[Menu/Select]**. Select the GLOBAL SETUP menu, and then the INSERT 0 submenu.
- 2) Move the cursor to select ON or OFF.
- 3) Press **[Menu/Select]**. You will hear a confirmation tone.

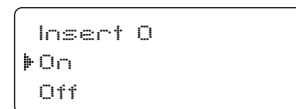

Expanding Your Phone

Adding Accessory Handsets

Your phone supports a total of six cordless handsets. You can now place a fully-featured cordless handset anywhere AC power is available to connect the handset charger. All the handsets ring when a call is received.

Compatible Handsets

Your phone is compatible with the **DECT 6005**. If you purchased an accessory handset separately, you must register the handset to the base before use. Accessory handsets will not operate until they are registered.

Charging Accessory Handsets

The handset's battery recharges automatically when the handset is placed in the charger.

- 1) Use the supplied AC adapter (AAD-600S) to connect the DC IN 9V jack to a standard 240V AC outlet.
- 2) Set the charger on a desk or tabletop, and place the handset in the charger with the LCD screen facing forward.
- 3) Make sure that the charge LED illuminates. If the LED does not illuminate, check to see that the AC adapter is plugged in and the handset makes good contact with the charging contacts.
- 4) Charge the handset battery pack for at least 15-20 hours before using your new handset for the first time.

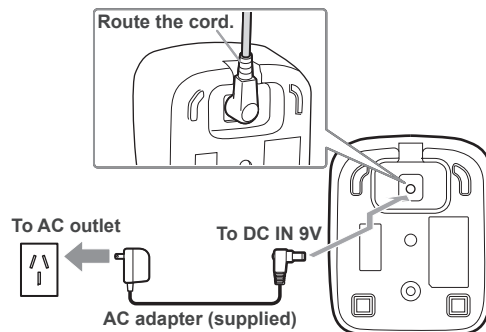

Caution: Use only the Uniden AAD-600S adapter.

Registering DECT 6005 Accessory Handsets

If you purchase an accessory handset, you need to register the handset before use. Handset(s) supplied in the box with the base are pre-registered at the factory. When charged, pre-registered handsets display a handset ID number. Handsets that have not been registered display:

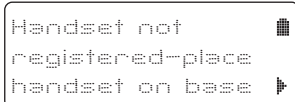

Handset not
registered—place
handset on base

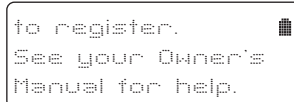

to register.
See your Owner's
Manual for help.

To register an accessory handset:

- 1) Charge the handset for 15-20 hours.
- 2) Place the handset in the main telephone base cradle to initiate registration. HANDSET REGISTERING will appear in the LCD.
- 3) Wait approximately thirty seconds, "REGISTRATION COMPLETE" will be displayed to indicate the handset has been registered to the base and a handset ID will be automatically assigned.

If REGISTRATION FAILED appears in the LCD, please try these steps again.

Note: If an accessory handset has ever been registered to a base, you must reset the handset before you can register it to a new base. See Resetting the Handset on page 48.

Using Multiple Bases

DECT 6005 handsets and the handsets supplied with your phone can be registered to a total of four different DECT6015 or DECT6035 bases. Once your handset is registered to more than one base, you can set the handset to search automatically the available base, or you can select manually which base the handset should connect to (for example, if you have one base with an answering machine, you can tell the handset to connect that base to check messages).

Registering the Handset to Another Base

To register a handset to another base:

- 1) Make sure the handset battery is fully charged.
- 2) On the base, disconnect the base AC adapter. Then press and hold **[find hs]** while you reconnect the adapter. Keep pressing **[find hs]** until the charge LED starts to blink.
- 3) On the handset, Press **[Menu/Select]**. Select the REGISTER BASE menu. HANDSET REGISTERING will appear in the display.
- 4) Wait approximately thirty seconds. "REGISTRATION COMPLETE" will be displayed to indicate the handset has been registered to the base and a handset ID will be automatically assigned.

If REGISTRATION FAILED appears in the LCD, please try these steps again.

Selecting the Base

When your handset is registered to another base, it will automatically connect to the base. A base ID (that is for the handset only) will be assigned in the order of registration. You can either select a base you want to use manually, or set to AUTO. If you set to AUTO, when the handset comes out of range, it searches automatically the available base in order of base ID.

- 1) With the phone in standby, press **[Menu/Select]**. Select the HANDSET SETUP menu, and then the SELECT BASE submenu.
- 2) Move the cursor to select the base you want to connect to, or choose AUTO to have the handset automatically select the base.
- 3) Press **[Menu/Select]**. SEARCHING will appear in the display.



- 4) When the base is found, the handset will return to standby. If the base is not found, "SEARCHING" continues to appear. You can repeat the procedure listed above to return back to the original connection or to find the different base.

Notes: • You cannot change bases during a call.

- To confirm which bases the handset is registered to, open the SELECT BASE submenu and use [▲] and [▼] to scroll through the list. Press [i] to close the list and return to standby.

Setting Up the Phonebook

Your handset can store up to seventy names and numbers in your phonebook. When all the phonebook entries are full, you will hear a beep and MEMORY FULL appears. You cannot store any additional names and numbers unless you delete some of the existing ones.

You can also use the phonebook entries to store a group of numbers (up to twenty digits) that you may need to enter once your call connects. This is referred to as chain dialing. See Chain Dialing from the Phonebook on page 29.



Creating Phonebook Entries

To store names and numbers in your phonebook, please follow these steps:

- 1) When the phone is in standby mode, press [M] (on the left side of the four-way key).
- 2) To create a new phonebook entry, press [Menu/Select]. Select the CREATE NEW menu. EDIT NAME appears.
- 3) Enter the name for this entry (EDIT NAME).

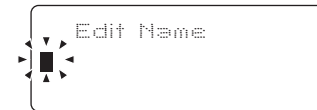

Use the keypad to enter a name for this entry; the name can contain up to sixteen characters. (See Entering Text from Your Handset on page 11 for instructions on entering text.) If you do not want to enter a name for this entry, your phone will store this entry as <NO NAME>. Press [Menu/Select] when you are finished.



4) Enter the number for this entry (EDIT NUMBER).

Once you have stored a name, EDIT NUMBER appears next. Use the number keypad to enter the phone number; the phone number can contain up to twenty digits. If you need the phone to pause between digits when it's dialing (for example, to enter an extension or an access code), press **[Redial/Pause]** to insert a two-second pause. You will see a P in the display. You can also use more than one pause together if two seconds is not long enough. Each pause counts as one digit. Press **[Menu/Select]** when you are finished.

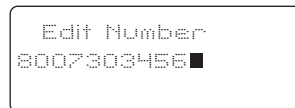

5) Assign a personal ring tone for this entry (PERSONAL RING).

You can attach a special ring tone to each phonebook entry; the phone will use this ring tone when this person calls. Use **[▲]** and **[▼]** to select one of the seven different ring tone options (see Selecting a Ring Tone on page 27 for a complete list of ring tones). As you scroll through the tones, you will hear a sample of each tone. When you hear the ring tone you want to use, press **[Menu/Select]**. If you do not want to use a personal ring tone for this phonebook entry, choose NO SELECTION; the phone will use your standard ring tone setting.

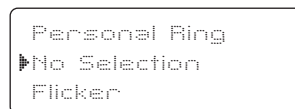

6) You will hear a tone confirming that the new entry has been stored, and DONE! appears in the display.

Finding a Phonebook Entry

Press **[Ⓜ]** to open the phonebook. Phonebook entries are stored in alphabetical order. To scroll through the phonebook from A to Z, press **[▼]**. To scroll trough the phonebook from Z to A press **[▲]**.

You can also use the letters on the number keys to jump to a name that starts with that letter. For example, to search for an entry beginning with the letter M, press **[6]** once. The phonebook jumps to the first entry that begins with the letter you entered; you can then use **[▲]** and **[▼]** to scroll to other entries.



To close the phonebook, press **[Ⓜ]**. During a call, press **[Ⓜ]** again instead of **[Ⓜ]** to close the phonebook.

Editing an Existing Phonebook Entry

- 1) When the phone is in standby, press [] to open the phonebook.
- 2) Find the entry you want to edit and press **[Menu/Select]**.
- 3) Select EDIT. Follow the steps for Creating Phonebook Entries on page 22. If you do not wish to change the information at any step, simply press **[Menu/Select]** to go to the next step.

Storing Caller ID or Redial Numbers in the Phonebook

You can store Caller ID records or redial numbers in the phonebook so you can use them later. Go to the Caller ID or redial list and select the number you want to store. (If the Caller ID information did not include the number, then you will not be able to store it.)

- 1) When the phone is in standby, press [] to open the Caller ID list or **[Redial/Pause]** to open the redial list.
- 2) Use [] and [] to scroll through the Caller ID records or redial numbers. When you come to the information you want to store, press **[Menu/Select]**.
- 3) Select STORE INTO PB. EDIT NAME appears. If the phone number is already stored in memory, you will hear a beep, and THIS DATA IS ALREADY SAVED! appears in the display. The number will not be stored.
- 4) Continue by following the steps for Creating Phonebook Entries on page 22.

Deleting Phonebook Entries

You can delete a single phonebook entry at a time or all phonebook entries at once:

To delete a single phonebook entry:

- 1) When the phone is in standby, press [].
- 2) Find the entry that you want to delete and press **[Menu/Select]**.
- 3) Select DELETE. DELETE ENTRY? appears in the display.
- 4) Move the cursor to select YES.
- 5) Press **[Menu/Select]**. You will hear a confirmation tone, and DELETED! appears in the display.

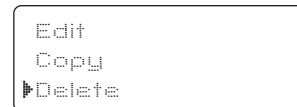



To delete all phonebook entries:

- 1) When the phone is in standby, press [].
- 2) Press [**Menu/Select**], and then select DELETE ALL. DELETE ALL? appears in the display.
- 3) Move the cursor to select YES.
- 4) Press [**Menu/Select**]. You will hear a confirmation tone, and DELETED! appears in the display.

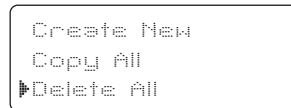

Copying Phonebook Entries to Another Handset

If you have more than one handset, you can transfer phonebook entries from one handset to another without having to re-enter names and numbers. You can transfer one phonebook entry at a time or all phonebook entries at once.

- 1) When the phone is in standby, press [].
- 2) To copy one entry, find the phonebook entry you want to copy. Press [**Menu/Select**], and then select COPY. To copy all entries, press [**Menu/Select**], and then select COPY ALL.
- 3) Move the cursor to select the handset which you want to transfer the entries to and then press [**Menu/Select**]. If you select COPY ALL, ARE YOU SURE? appears on the display screen. Move the cursor to select YES, and then press [**Menu/Select**].
- 4) The phonebook entries will be transferred to the designated handset. During the copy process, the receiving handset shows RECEIVING and the Handset ID of the sending handset.
- 5) When the transfer is completed, DONE! appears on the handset.

Notes: • The handsets must be currently connected to the same base (see page 21).

- If your phonebook contains seventy entries, you cannot store any new phonebook entries. You will hear a beep, and NOT ENOUGH MEMORY IN RECEIVING UNIT appears on the display. If the selected handset is out of range or data transfer is cancelled, UNAVAILABLE appears in the display. Phonebook listings will not be transferred.





Using the Voice Mail Service

If you subscribe to a voice mail service, you can use your phone to access your voice mailbox. The **new message** LED on the handset flashes and  appears in the handset display whenever you have messages waiting in your voice mailbox. When you subscribe to the service, your voice mail provider provides you with the access number and the required voice mail signaling tone. You can use your phonebook to store the access number.

Resetting the Voice Message Waiting Indicator

When you receive a new voice mail message, the **new message** LED on the top of the handset flashes and  appears in the handset display. In the event your message alert tone gets out of sync with your phone company's voice messaging system, you can reset back to its original "no messages waiting" state. To reset, press and hold **[find hs]** on the base for five seconds. A beep sounds and the message alert tone is reset.

Customizing Your Phone Changing the Handset Banner

Each handset will display a banner name once it is registered to the base. The default banner is Handset #1, Handset #2, etc. You can change the name your phone displays by changing the banner display. If you have more than one handset, the banner name identifies your handset.

- 1) Press **[Menu/Select]**. Select the HANDSET SETUP menu, and then the BANNER submenu.
- 2) Use the keypad to enter or edit the banner name. (See Entering Text from Your Handset on page 11 for detailed instructions on entering text.)
- 3) Press **[Menu/Select]**. You will hear a confirmation tone.

Note: When you have multiple bases and even if the handset ID is changed when you switch to a different base, the handset will keep the banner name.



Selecting a Ring Tone (Handset only)

You may choose from four melodies or three tones for your phone's primary ring tone. Each handset can use a different ring tone or melody. The available ring tones are as listed:

Melodies	Fur Elise (ELISE)	Tones	Flicker
	We Wish You A Merry Christmas (MERRY-XMAS)		Clatter
	Aura Lee (AURA LEE)		Wake Up
	Waltzing Matilda (W MATILDA)		

- 1) Press **[Menu/Select]**. Select the HANDSET SETUP menu, and then the RINGER TONES submenu.
- 2) Move the cursor to select a ring tone. As each ring tone is highlighted, you will hear a sample.
- 3) When you hear the tone you want to use, press **[Menu/Select]**. You will hear a confirmation tone.

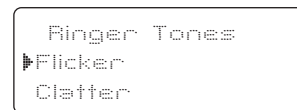

Activating AutoTalk

AutoTalk allows you to answer the phone simply by picking up the handset from the cradle. You do not have to press a button to answer the call.

- 1) Press **[Menu/Select]**. Select the HANDSET SETUP menu, and then the AUTOTALK submenu.
- 2) Move the cursor to select ON or OFF.
- 3) Press **[Menu/Select]**. You will hear a confirmation tone.

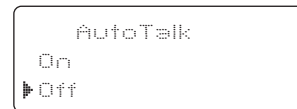

Activating Any Key Answer

Any Key Answer allows you to answer the phone by pressing any key on the dial pad.

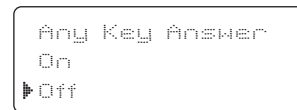

- 1) Press **[Menu/Select]**. Select the HANDSET SETUP menu, and then the ANY KEY ANSWER submenu.
- 2) Move the cursor to select ON or OFF.
- 3) Press **[Menu/Select]**. You will hear a confirmation tone.





Using Your Phone

	From a cordless handset	From a handset speaker phone
Making a call	1) Pick up the handset from the cradle. 2) Press [*/Flash] . 3) Listen for the dial tone. 4) Dial the number. OR 1) Pick up the handset from the cradle. 2) Dial the number. 3) Press [*/Flash] .	1) Pick up the handset from the cradle. 2) Press [Mute] . 3) Listen for the dial tone. 4) Dial the number. OR 1) Pick up the handset from the cradle. 2) Dial the number. 3) Press [Mute] .
Answering a call	1) Pick up the handset. (If AutoTalk is on, the phone will answer when you pick up the handset from the cradle.) 2) Press [*/Flash] . (If Any Key Answer is on, you can also press any key on the dial pad.)	1) Pick up the handset. 2) Press [Mute] .
Hanging up	Press [*] or return the handset to the cradle.	Press [*] or return the handset to the cradle.



Making a Call from the Phonebook

- 1) When the phone is in standby, press [] to open the phonebook.
- 2) Find the phonebook entry you want to call (see Finding a Phonebook Entry on page 23).
- 3) Press [ /Flash] or [] to dial the number.



Note: You can also press [ /Flash] or [] before you open the phonebook. When you come to the phone number you want to dial, press [Menu/Select].

Chain Dialing from the Phonebook

You can use the phonebook entries to store a group of numbers (up to twenty digits) that you may need to enter once your call connects.

- 1) Dial the number normally.
- 2) After the call connects, press [].
- 3) Use [] or [] to select the phonebook entry that contains the digits you want to send.
- 4) Press [Menu/Select].

Switching to the Handset Speakerphone During a Call

To switch a normal call to the speakerphone, press [] on the handset. To switch from a speakerphone call to a normal call, press [].

Using Caller ID, Call Waiting, and Redial Lists

If you subscribe to Caller ID service from your phone company, your phone will show you the caller's phone number and name (if available) whenever a call comes in. If you subscribe to Caller ID on Call Waiting, the phone will also show you the name and the number of any call that comes in while you're on the line.

Using the Caller ID List

You can store up to thirty Caller ID numbers in each handset. Caller ID records are stored from newest to oldest. Once your Caller ID list is full, the oldest record will be automatically deleted when a new call is received.

To open the Caller ID list, press **[*#]** (on the right side of the four-way key). The phone will show the number of new Caller ID records and the total number of stored records. Use **[▲]** and **[▼]** to scroll through the list.

```
Caller ID
New : 1
Total:30
```

```
2/12 12:00PM
Jane Smith
214-555-1234
```

Making a Call from a Caller ID Record

- 1) When the phone is in standby, press **[*#]** to open the Caller ID list.
- 2) Use **[▲]** and **[▼]** to find the Caller ID record you want to dial.
- 3) Press **[#/Flash]** or **[*#]** to dial the number.

Note: You can also press **[#/Flash]** or **[*#]** before you open the caller ID list. When you come to the phone number you want to dial, press **[Menu/Select]**.



Deleting Caller ID Numbers

To delete only one Caller ID number, press **[*#0#]** when the phone is in standby, and then find the number you want to delete. Press **[Menu/Select]** and select DELETE ENTRY. When the phone asks you to confirm, select YES.

To delete all the Caller ID numbers, press **[*#0#]** when the phone is in standby, and then press **[Menu/Select]**. When the phone asks you to confirm, select YES.

Note: When you delete a Caller ID number, you delete it permanently.

Using Call Waiting

If you have Call Waiting service and a second call comes in when you are on the phone, a call waiting tone will sound. (If you subscribe to Caller ID on Call Waiting, the handset displays the name and phone number of the waiting call.)

For Australian Model:

Press **[*]/[Flash]** and then **[2]** on the handset to accept the waiting call. The first caller is put on hold, and you will hear the new caller after a short pause. To return to the original caller, press **[*]/[Flash]** and then **[2]** again.

For New Zealand Model:

Press **[*]/[Flash]** on the handset to accept the waiting call. The first caller is put on hold, and you will hear the new caller after a short pause. To return to the original caller, press **[*]/[Flash]** again.

Note: You must subscribe through your telephone provider to receive Call Waiting services.

Redialing a Number

You can quickly redial the last five numbers dialed on each handset.

- 1) When the phone is in standby, press the **[Redial/Pause]** to open the redial list.
- 2) Use **[▲]** and **[▼]** or **[Redial/Pause]** to scroll through the redial list.
- 3) When you find the number you want to dial, press **[*]/[Flash]** or **[*][*]**.

Notes:

- If the number exceeds 32 digits, only the first 32 digits are retained in redial memory.
- If the redial memory is empty, EMPTY appears in the display and you will hear a beep.
- You can also press **[*]/[Flash]** or **[*][*]** before you open the redial list. When you come to the phone number you want to dial, press **[Menu/Select]**.





Deleting a Redial Record

If you want to delete a phone number from the handset's redial list, follow the steps below:

- 1) When the phone is in standby, press **[Redial/Pause]**.
- 2) Use **[▲]** and **[▼]** to scroll through the redial list.
- 3) When you find the redial number you want to delete, press **[Menu/Select]** and select DELETE ENTRY.
- 4) When the phone asks you to confirm, select YES. The redial number is deleted.

Adjusting the Ringer, Earpiece and Speaker Volume

Adjusting the Ringer Volume

You can choose from four ringer volume settings (off, low, medium, and high) on the handset or the base.

Handset: With the phone in standby, use **[▲]** to make the ringer volume louder or **[▼]** to make it softer or turn it completely off.

Base: While the phone is ringing or in standby, use **[volume +]** to make the ringer volume louder or **[volume -]** to make it softer or turn it completely off.

Adjusting the Earpiece Volume

You can choose from six volume levels for the earpiece. To adjust the earpiece volume while on a call, press **[▲]** (to make it louder) or **[▼]** (to make it softer).

Adjusting the Speaker Volume

Handset Speakerphone: You can choose from six volume levels for the handset speakerphone. To adjust the speaker volume while on a speakerphone call, press **[▲]** (to make it louder) or **[▼]** (to make it softer).

Base Speaker: You can choose from ten volume levels for the base speaker. To adjust the speaker volume while call screening or playing messages, press **[volume +]** (to make it louder) or **[volume -]** (to make it softer).

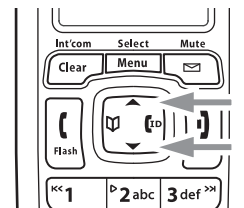



Adjusting the Audio Tone

If you aren't satisfied with the audio quality of your phone, you can adjust the Audio Tone of the earpiece while on a call. Your phone gives you three audio tone options: low, natural and high; the default setting, Natural Tone, is recommended for hearing aid users. Audio tone adjustments only apply to the earpiece, not the speakerphone.

To adjust the audio tone:

- 1) While on a call, press **[Menu/Select]**.
- 2) Move the cursor to select AUDIO TONE, and then press **[Menu/Select]**.
- 3) Move the cursor to select desired option (HIGH TONE, NATURAL TONE, or LOW TONE), and then press **[Menu/Select]**. Selected option appears in the display for two seconds, and then the display returns to normal.

Finding a Lost Handset

To locate a misplaced handset, press **[find hs]** on the base when the phone is in standby. The handsets connected to the paging base will beep for one minute, and PAGING appears on the handset display. To cancel paging, press **[find hs]** again or any key on the found handset.

Note: Handsets that are not currently connected to this base will not be paged.

Using Hold, Conference and Transfer

Placing a Call on Hold

- 1) During a call, press **[Clear/Int'com]** on the handset to place the caller on hold. If you leave a caller on hold for more than ten seconds, the display screen will read, Line On Hold.
- 2) To return to the party on hold, press **[[/Flash]** or **[Mute]** on a handset. The phone will return to the holding party.

Notes:

- You can only place a caller on hold for five minutes. Once five minutes has passed, that party's line will be disconnected and the phone will return to standby.
- While a call is on hold, Caller ID and Call Waiting cannot be received.





Conferencing

If you have more than one handset, up to three people can participate in a conference call. A three-way conference call consists of an outside line and two handsets. You can easily join a call already in progress. The handsets must be currently connected to the same base (see page 21).

- 1) Press **[*/Flash]** or **[*]]]** to join the call.
- 2) To hang up, return the handset to the cradle or press **[*]**. The other party will still be connected to the call.

Transferring a Call

You can transfer a call from one handset to another. The handsets must be currently connected to the same base (see page 21).

- 1) During a call, press **[Clear/Int'com]**.
- 2) Use **[▲]** or **[▼]** to select the handset you want to transfer the call to, and then press **[Menu/Select]**. Select ALL to page all other handsets. The call will automatically be placed on hold, and a paging tone sounds. To cancel the transfer, press **[*/Flash]** or **[*]]]**.
- 3) When another handset accepts the transferred call, you will be disconnected. If you want to rejoin the call, press **[*/Flash]** again or **[*]]]**.

Answering a Transferred Call

When a handset receives a call transfer, it sounds a paging tone; handsets also show the ID of the handset that is paging. To accept the call transfer:

- 1) To answer the page and speak to the transferring handset, press **[*/Flash]** or **[Clear/Int'com]**.
- 2) To accept the call and speak to the caller, press **[*/Flash]**.
- 3) When you accept the transferred call, the transferring handset will be disconnected.

Only the first handset to answer the transfer page will be connected to the call. If the transfer page is not picked up within one minute, the operation will be canceled.



Using Special Features

Privacy Mode

If you don't want other handsets to interrupt you while on a call, turn on privacy mode. As long as your handset is in privacy mode, other handsets can't join your call or make any calls of their own: their displays will show UNAVAILABLE.

- 1) While on a call, press **[Menu/Select]**.
- 2) Select CALL PRIVACY. PRIVACY MODE ON appears in the display for two seconds;  appears and remains in the display until the feature is turned off.

To turn privacy mode off, repeat the procedure listed above. PRIVACY MODE OFF appears.

Using the Intercom

You can use the intercom to talk to another handset without using the phone line. The handsets must be currently connected to the same base (see page 21).

Making an Intercom Page

- 1) When the phone is in standby, press **[Clear/Int'com]**.
- 2) Use **[▲]** or **[▼]** to select the handset you want to talk with, and then press **[Menu/Select]**. Select ALL to page all other handsets.
- 3) To cancel the intercom page, press **[i]**.

Note: Intercom paging will be cancelled if any of the following things occur:

- You receive an outside call or an intercom page while selecting the other handset.
- You do not select a handset within thirty seconds.
- Your handset is out of range (OUT OF RANGE appears in the display).
- The party does not answer the page within one minute.
- The party is busy.
- The party is out of range (UNAVAILABLE appears in the display).



Answering an Intercom Page

When the intercom page tone sounds, the display will show the ID of the handset that is paging.



- 1) Press **[Flash]** or **[Clear/Int'com]**. If AutoTalk is on, the handset will automatically answer the page when you pick up the handset from the cradle.
- 2) To hang up an intercom page, press **[*]**.

Muting the Ringer (One call only)

While the phone is ringing, press **[*]** on the handset or **[D/O]** on the base to mute the ringer for this call. The phone will ring again on the next call.

Muting the Microphone

Mute turns off the microphone so the caller can't hear you. This only works while you are on a call.

- 1) Press **[M/Mute]**. MUTE ON and  appear in the display;  remains while muting is on.
- 2) To cancel muting, press **[M/Mute]** again. MUTE OFF appears.



Line Mode Setup (Base only)

The Line Mode Setup feature is only used in instances where you have multiple phones where users may pick up an extension while someone else is on the phone. Only in very rare instances where your phone system is not detecting that an extension phone is picked up will you ever need to change this feature. There are three settings for this feature: TYPE-A, TYPE-B, or OFF, but change this option only when instructed to by customer service. In most all situations, this feature will never need to be used or modified from the factory default setting of TYPE-A.

- 1) If you have multiple bases, select the base you need to change the setting (see page 21).
- 2) Press **[Menu/Select]**. Select the GLOBAL SETUP menu, and then the SET LINE MODE submenu.
- 3) IF INSTRUCTED BY CUSTOMER SERVICE PRESS **[SELECT]** appears. Press **[Menu/Select]**.
- 4) Move the cursor to select TYPE - A, TYPE - B, or OFF.
- 5) Press **[Menu/Select]**. You will hear a confirmation tone.

Installing the Optional Headset

Your phone may be used with an optional headset. To use this feature, insert the headset plug into the headset jack. Your phone is ready for hands-free conversations. (Headsets may be purchased by calling the Uniden Parts Department. See inside the back cover page for contact information.)



Setting Up the Answering System

Using the Answering System Setup Menus

Your handset controls all of the answering system setup options except for the personal greeting (personal greetings must be changed directly at the base). Here are some hints on using your handset to access your answering system:

- If you have multiple bases, select the base with answering system you want to access (see page 21).
- When the phone is in standby, press [**✉/Mute**] on the handset to access the answering system. REMOTE ANSWERING MACHINE OPERATION appears on the handset display, and the system announces the number of new and old messages.
- After the first announcement, you have thirty seconds to enter your first command before the system returns to standby.
- If you receive a call, remote operation is cancelled.
- If another handset makes a call, remote operation is cancelled.
- During remote operation “ - - ” appears on the base.

Recording a Personal Greeting

Your answering system comes with a pre-recorded outgoing message or greeting that plays when you receive a call: “Hello, no one is available to take your call. Please leave a message after the tone.” You can record your own personal outgoing greeting. Your recorded greeting must be between two seconds and thirty seconds long.

- 1) On the base, press and hold [**greet**].
- 2) The system announces, “Record greeting.” Begin recording after the announcement. The **message counter** LED displays “ - - ”, and then begins to count down thirty seconds.
- 3) When you finish recording, press [**greet**] again or press [**▷/□**]. You will hear a confirmation tone, and your recorded greeting plays back for you.

Selecting a Greeting

Once you have recorded a personal greeting, the phone automatically switches to your personal greeting. You can also switch back and forth between the pre-recorded greeting and your own greeting at any time.

- 1) When the phone is in standby, press **[greet]** on the base. The system plays the current greeting.
- 2) To keep this greeting, do nothing.
- 3) To switch to the other greeting, press **[greet]** while the system is playing the current greeting.
- 4) Each time you press **[greet]**, the system switches between the pre-recorded and the personal greeting. The last greeting you hear is used as the current greeting.

Deleting Your Personal Greeting

You can delete your personal greeting from the base. You cannot delete the pre-recorded greeting.

- 1) When the phone is in standby, press **[greet]** on the base.
- 2) While the personal greeting is playing, press **[Ø]**.
- 3) The system announces “Greeting has been deleted,” and switches back to the pre-recorded greeting.



Setting the Number of Rings

The ring time setting allows you to set the number of rings the caller hears before your answering system plays the outgoing message. You can set the ring time to answer after six, nine, or twelve rings. If you enable the Toll Saver (TS) setting, the answering system picks up after two rings if you have new messages, and after four rings if there are none. This way, if you make a long distance call to check your messages, you can hang up after the third ring to avoid long distance billing charges.

- 1) On the handset, press **[Menu/Select]**. Select the ANSW. SETUP menu, and then the RING TIME submenu.
- 2) Move the cursor to select a ring time (TOLL SAVER, 6 TIMES, 9 TIMES, or 12 TIMES).
- 3) Press **[Menu/Select]**. You will hear a confirmation tone.

Setting the Day & Time

If you do not set the clock on your answering system, your messages may not have the correct time and day stamp.

- 1) On the handset, press **[Menu/Select]**.
- 2) Move the cursor to DAY & TIME and press **[Menu/Select]**.
- 3) Use **[▲]** and **[▼]** to select the day of the week, and press **[Menu/Select]**.
- 4) Use the number keypad (**[0]** through **[9]**) to enter the hour and minutes.
- 5) Use **[▲]** and **[▼]** to select AM or PM, and press **[Menu/Select]**. You hear a confirmation tone.

Setting the Record Time (or Announce only)

You can choose how long callers have to record a message. Set the record time to “1 minute” or “4 minutes” to limit the time for incoming messages. If you set the record time to “Announce only,” the answering system answers the call but prevents callers from leaving a message.

- 1) On the handset, press **[Menu/Select]**. Select the ANSW. SETUP menu, and then the RECORD TIME submenu.
- 2) Move the cursor to select a record time (1 MINUTE, 4 MINUTES, or ANNOUNCE ONLY).
- 3) Press **[Menu/Select]**. You will hear a confirmation tone.



While your answering system is set to “Announce only,” the **message counter** LED on the base displays “A.” If you are using the prerecorded greeting, the system automatically switches to the following message: “Hello, no one is available to take your call. Please call again.” If you are using a personal greeting, the system continues to use that greeting.

Activating the Message Alert

The message alert feature sounds a short alert tone every fifteen seconds whenever you have a new message. To turn on the message alert:

- 1) On the handset, press **[Menu/Select]**. Select the ANSW. SETUP menu, and then the MESSAGE ALERT submenu.
- 2) Move the cursor to select ON or OFF.
- 3) Press **[Menu/Select]**. You will hear a confirmation tone.

Activating Call Screening

Your phone allows you to listen to callers leaving you a message. This call screen feature can be turned on or off.

- 1) On the handset, press **[Menu/Select]**. Select the ANSW. SETUP menu and then the CALL SCREEN submenu.
- 2) Move the cursor to select ON or OFF.
- 3) Press **[Menu/Select]**. You will hear a confirmation tone.

Setting a Security Code or Personal Identification Number (PIN)

To play your messages from a remote location, you will need to enter a two-digit security code or Personal Identification Number (PIN). The default security code is 80.

- 1) On the handset, press **[Menu/Select]**. Select the ANSW. SETUP menu, and then the SECURITY CODE submenu.
- 2) Use the number keypad (**[0]** through **[9]**) to enter a two-digit security code (00-99).
- 3) Press **[Menu/Select]**. You will hear a confirmation tone.



Using the Answering System

Turning Your Answering System On and Off

	From the base	From the handset
Turning On	<ol style="list-style-type: none">1) When the phone is in standby, press [answer on/off].2) The system announces "Answering System is on" and plays the current greeting.3) The message counter LED displays the number of messages stored in memory. If the counter flashes, then you have new messages waiting.	<ol style="list-style-type: none">1) Press [Menu/Select]. Select the ANSW. SETUP menu, and then the ANSWER SETUP submenu.2) Move the cursor to select ON.3) Press [Menu/Select]. You will hear a confirmation tone.
Turning Off	<ol style="list-style-type: none">1) When the phone is in standby, press [answer on/off].2) The phone announces "Answering System is off."3) The message counter LED is no longer illuminated.	<ol style="list-style-type: none">1) Press [Menu/Select]. Select the ANSW. SETUP menu, and then the ANSWER SETUP submenu.2) Move the cursor to select OFF.3) Press [Menu/Select]. You will hear a confirmation tone.

Reviewing Messages

The base **message counter** LED displays the number of messages stored in memory. When you have new messages, the **message counter** LED on the base and the **new message** LED on the handset flash. The answering system plays your new messages first. After you listen to all of your new messages, you can then play your old messages. You can review your messages from the base or from the handset:

	From the base	From the handset
Playing messages	Press [>/0]. The system announces the number of new and old messages, plays the message, and then announces the time and day it was received.	Press [☒/Mute]. The system announces the number of new and old messages, plays the message, and then announces the time and day it was received.
Repeating a message	Press [<<] once to go to the beginning of the current message. Press [<<] repeatedly to go back to a previous message.	Press [1] once to go to the beginning of the current message. Press [1] repeatedly to go back to a previous message.
Skipping a message	Press [>>] to go to the beginning of the next message.	Press [3] to go to the beginning of the next message.
Deleting a message	While a message is playing, press [0]. The message is permanently deleted.	While a message is playing, press [4]. The message is permanently deleted.
Deleting all messages	While the phone is in standby, press [0]. When the system asks you to confirm, press [0] again. All messages are permanently deleted.	Not available.
Ending the message review	Press [>/0] to stop the message playback and return to standby.	Press [5] to stop the message playback. Press [1] to exit the system and return to standby.

Screening Calls

If you activate the call screening feature, you can listen to callers leaving a message without answering the phone (see Activating Call Screening on page 41). You can always hear callers from the base speaker. To screen an incoming call from the handset:

- Press **[Mute]** when the system is answering. If another handset is screening a call, you will hear a beep and you will not be able to screen the call.
- To answer the call, press **[Flash]**.
- To stop screening the call, press **[*]**.

Turning Off the Message Alert Tone

When all new messages are played back, the message alert tone will automatically deactivate. The tone will not deactivate until all new messages are played back. To quickly turn off the tone, press any key on the base.



Operating the Answering System While You Are Away from Home

You can access your answering system while you are away from home to check, play, and delete messages, or turn your answering system on and off.

Notes:

- The answering system will only playback messages for four minutes and then it returns to the command waiting mode. To continue playing your messages, press [#] then [2] again within fifteen seconds.
- If you enter an incorrect security code three times, you will hear a beep and the answering system will return to standby.

To operate from a remote location, use any touch-tone telephone, and follow these steps:

- 1) Call your telephone number and wait for the system to answer. If the answering system is off, it will answer after about 15 rings and sounds a series of beeps.
- 2) During the greeting or the beeps (if answering system is off), press [#] and enter your security code/PIN within two seconds (see Setting a Security Code or Personal Identification Number (PIN) on page 41).
- 3) The answering system announces the current time and the number of messages stored in memory. You hear "To play incoming messages, press pound-two. For help, press pound-zero" followed by a beep.
- 4) Enter a remote command from the chart below. You have fifteen seconds to enter the first command; after the first command, you have two seconds to enter each command.

Remote Commands

Command	Function	Command	Function	Command	Function
[#] then [1]	Repeat a message*	[#] then [4]	Delete a message	[#] then [9]	Answering system off
[#] then [2]	Play incoming messages	[#] then [5]	Stop operation	[#] then [0]	Help
[#] then [3]	Skip a message	[#] then [6]	Answering system on		

* If you press [#] then [1] in the first four seconds of a message, the system skips to the previous message.
If you press [#] then [1] after the first four seconds of a message, the system repeats the current message.

- 5) When you finish, you will hear intermittent beeps indicating that the system is in the command waiting mode. Enter another command from the chart within fifteen seconds.
- 6) Hang up to exit the system. The answering system automatically returns to its normal standby setting.



Maintenance

Specifications

Operating Temperature	32° F to 122° F (0° C to 50° C)
AC Adapter Part Number	Base: AAD-041S Charger: AAD-600S
AC Adapter Input Voltage	Base: 240V AC, 50 Hz Charger: 240V AC, 50 Hz
AC Adapter Output Voltage	Base: 9V DC @ 350mA Charger: 9V DC @ 210mA
Battery Part Number	BT-652
Battery Capacity	2.4V DC @ 650mAh

Notes:

- Use only the supplied AC adapters.
- Be sure to use the proper adapter for the base and any chargers.
- Do not place the power cord where it creates a trip hazard or where it could become chafed and create a fire or electrical hazard.
- Do not place the base in direct sunlight or subject it to high temperatures.

Battery Replacement and Handling

With average use, your phone's battery should last approximately one year. To order replacement batteries, please visit Uniden's customer support page at www.uniden.com.au (Australian model) or www.uniden.co.nz (New Zealand model).

Caution:

- Use only battery pack BT-652.
- Do not remove the batteries from the handset to charge them.
- Never throw the battery into a fire, disassemble, or heat them.
- Do not remove or damage the battery casing.

Cleaning the Battery Contacts

To maintain a good charge, clean the charging contacts on the handset once a month. Dampen a cloth with plain water. Gently rub the damp cloth over the charging contacts until all visible dirt is removed. Dry the contacts thoroughly before returning the handset to the cradle.

Caution: Do not use paint thinner, alcohol, or other chemical products. Doing so may discolor the surface of the telephone and damage the finish.

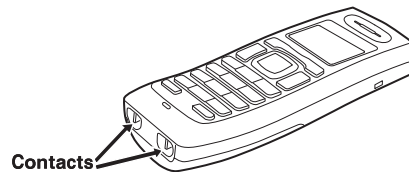

Low Battery Alert

When the battery pack is very low, the phone is programmed to eliminate functions in order to save power. When LOW BATTERY appears in the display and the phone is in standby, none of the keys will operate. If you are on a call, complete your conversation as quickly as possible, and return the handset to the cradle.

The battery pack needs to be charged when the empty battery icon appears.

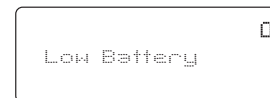

Battery Life

With average use, your handset battery provides approximately ten hours of talk time and approximately seven days of standby time. You can achieve optimum battery life and performance by returning the handset to the base or charger after each use. When your handset is left off of the cradle, the battery will gradually discharge even if the handset is not being used. The actual talk time duration will be reduced in proportion to the amount of time the handset is off of the cradle.

Power Failures

During a power failure, you will not be able to make or receive calls with the phone. To avoid damage from an electrical spike when the power comes back on, we recommend you unplug your phone during power outages.

Troubleshooting

Resetting the Handset

You may need to reset your handset in the following instances:

- You lose a handset and purchase a new one.
- You get the message Registration Failed when you try to register the handset.
- You are unable to register any handsets to the base.
- When you register new handsets to the base, the handset IDs do not match. (For example, the handset registers as "Handset #4" but you only have two handsets.)
- When you are instructed to by one of Uniden's call center representatives.

- 1) Select the base you want to de-register the handset from (see Selecting the Base on page 21).
- 2) Press and hold **[*]** and **[#]** for more than five seconds. Select DEREGISTER HS.
- 3) Select the handset which you are operating, and then press **[Menu/Select]**.
- 4) The phone will ask you to confirm the deregistration. Select YES. The selected handset will clear its registration information only from the base it is currently connected to, and then delete the link to the base from its own memory.
- 5) When the base information is deleted, the handset displays HANDSET NOT REGISTERED-PLACE HANDSET ON BASE TO REGISTER. SEE YOUR OWNER'S MANUAL FOR HELP.
- 6) Re-register the handset to the base (see Registering Accessory Handsets on page 20).

If the handset cannot contact the base, it will display OUT OF RANGE. Make sure the handset is in range of the base and the base is connected to power.



Resetting the Handset Without the Base

If your original base is not available for some reason, you can still reset the handset and use it with another base.

- 1) Press and hold **[*]** and **[#]** for at least five seconds.
- 2) Move the cursor to select BASEUNAVAILABLE and then press **[Menu/Select]**.
- 3) Select the base which you want to de-register from, and then press **[Menu/Select]**.
- 4) Move the cursor to select YES, and then press **[Menu/Select]**. You hear a confirmation tone, and the handset deletes its own base information without contacting the base. The handset displays HANDSET NOT REGISTERED-PLACE HANDSET ON BASE TO REGISTER. SEE YOUR OWNER'S MANUAL FOR HELP.
- 5) Register the handset to the new base (see Registering Accessory Handsets on page 20).

Traveling Out of Range

During a call, if you move your handset too far from your base, noise may increase. If you pass the range limit of the base, the handset will beep, display OUT OF RANGE, and then go to standby. The base will maintain the connection for thirty seconds after the handset goes out of range. If you move the handset back within range of the base within thirty seconds, press **[*/Flash]** or **[*]]]** to pick up the call again.

Note: If it is set to automatically select the available base, the handset will begin searching for another base thirty seconds after going out of range. (see Selecting the Base on page 21).

Common Issues

If your phone is not performing to your expectations, please try these simple steps first. If these steps do not solve your problem, please visit Uniden's customer support page at www.uniden.com.au (Australian model) or www.uniden.co.nz (New Zealand model).

Symptom	Suggestion
The charge LED won't illuminate when the handset is placed in the cradle.	<ul style="list-style-type: none">• Make sure the AC adapter is plugged into the base or the charger (if you have more than one handset) and wall outlet.• Make sure the AC outlet is not connected to a wall switch.• Make sure the handset is properly seated in the cradle.• Make sure the charging contacts on the handset are clean.
The audio sounds weak.	<ul style="list-style-type: none">• Move the handset and/or base away from metal objects or appliances.• Make sure that you are not too far from the base.
Can't make or receive calls.	<ul style="list-style-type: none">• Make sure that you are not too far from the base.• Make sure the line is not in use. If an outside call is already using a line, you cannot use that line to make another outside call.• Make sure your handset is registered to the base.• Check both ends of the base telephone cord.• Make sure the AC adapter is plugged into the base and wall outlet.• Disconnect the AC adapter and reconnect.
Severe noise interference.	<ul style="list-style-type: none">• Keep the handset away from microwave ovens, computers, remote control toys, wireless microphones, alarm systems, intercoms, room monitors, fluorescent lights, and electrical appliances.• Move to another location or turn off the source of interference.



Symptom	Suggestion
The Caller ID does not display.	<ul style="list-style-type: none">• The call was placed through a switchboard.• Call your telephone provider to verify your Caller ID service is current. There may be a problem with your Caller ID service.
The handset doesn't ring or receive a page.	<ul style="list-style-type: none">• Make sure that you are not too far from the base.• Make sure that your handset is registered to the base.• Charge the battery in the handset for 15 to 20 hours.
You cannot register the handset at the base.	<ul style="list-style-type: none">• Charge the battery pack in the handset for 15 to 20 hours.• Try resetting the handset (see Resetting the Handset on page 48).
The handset doesn't communicate with other handsets.	<ul style="list-style-type: none">• Make sure that you have registered all handsets to the same base, and all handsets are selecting the base (see page 21).
An extra handset can't join the conversation.	<ul style="list-style-type: none">• Make sure there are not two handsets already using the conference feature.• Make sure that another handset is not in privacy mode.• Make sure that you have registered both handsets to the same base, and both handsets are selecting the base (see page 21).
The answering system does not work.	<ul style="list-style-type: none">• Make sure the base is plugged in.• Make sure that the answering system is turned on.• Make sure that the message record time is not set to announce only.
Time stamp cannot be heard.	<ul style="list-style-type: none">• Make sure you have set the time (see Setting the Day and Time on page 40).
Messages are incomplete.	<ul style="list-style-type: none">• Incoming messages may be too long. Ask callers to leave a brief message.• The memory may be full. Delete some or all of the saved messages.
There is no sound on the base or handset speaker during call monitoring or message review.	<ul style="list-style-type: none">• Adjust the speaker volume on the base or handset.• Make sure the call screen feature is set to on.





Symptom	Suggestion
Cannot access answering system from a remote phone.	<ul style="list-style-type: none"> • Make sure you are using the correct PIN number. • Make sure that the touch-tone phone you're using can transmit the tone for at least two seconds. If it cannot, try using a different touch-tone phone.

Liquid Damage

Moisture and liquid can damage your cordless phone.

- If the handset or base is exposed to moisture or liquid, but only the exterior plastic housing is affected, wipe off the liquid, and use as normal.
- If moisture or liquid has entered the plastic housing (i.e. liquid can be heard in the phone or liquid has entered the handset battery compartment or vent openings on the base), follow the steps below:

Handset	Base
<ol style="list-style-type: none"> 1) Remove the battery cover and leave it off for ventilation. 2) Disconnect the battery pack. Leave the battery cover off and the battery pack disconnected for at least 3 days. 3) Once the handset is completely dry, reconnect the battery pack and the battery cover. 4) Recharge the handset's battery pack for 15 to 20 hours before using. 	<ol style="list-style-type: none"> 1) Disconnect the AC adapter from the base, cutting off electrical power. 2) Disconnect the telephone cord from the base. 3) Let dry for at least 3 days.

IMPORTANT: You must unplug the telephone line while recharging the battery packs to avoid charge interruption.

CAUTION: **DO NOT use a microwave oven to speed up the drying process. This will cause permanent damage to the handset, base and the microwave oven. After following these steps, if your cordless telephone does not work, please visit Uniden's customer support page at www.uniden.com.au (Australian model) or www.uniden.co.nz (New Zealand model).**



Precautions!

Before you read anything else, please observe the following:

Warning!

Uniden Australia and Uniden New Zealand DOES NOT represent this unit to be waterproof. To reduce the risk of fire, electrical shock, or damage to the unit, DO NOT expose this unit to rain or moisture.

Rechargeable Nickel-Metal-Hydride Battery Warning

- This equipment contains a rechargeable Nickel-Metal-Hydride battery.
- The rechargeable batteries contained in this equipment may explode if disposed of in a fire.
- Do not short-circuit the battery.
- Do not charge the rechargeable battery used in this equipment in any charger other than the one designed to charge this battery as specified in the owner's manual. Using another charger may damage the battery or cause the battery to explode.

Rechargeable Batteries Must Be Recycled or Disposed of Properly.

Uniden works to reduce lead content in our PVC coated cords in our products and accessories.

Important Safety Instructions

When using your telephone equipment, basic safety precautions should always be followed to reduce the risk of fire, electric shock and injury to persons, including the following:

1. Do not use this product near water, for example, near a bath tub, wash bowl, kitchen sink or laundry tub, in a wet basement or near a swimming pool.
2. Avoid using a telephone (other than a cordless type) during an electrical storm. There may be a remote risk of electric shock from lightning.
3. Do not use the telephone to report a gas leak in the vicinity of the leak.
4. Use only the power cord and batteries indicated in this manual. Do not dispose of batteries in a fire. They may explode. Check with local authorities for possible battery disposal instructions.
5. Do not disassemble any component of this product.

SAVE THESE INSTRUCTIONS

CAUTION

Risk of explosion if battery is replaced by an incorrect type. Dispose of used batteries according to the instructions. Do not open or mutilate the battery, and disconnect the battery before shipping this product.

Index

A

Answering calls.....	28
Answering system	38
Using the answering system	
interface.....	38
When away from home	45
Any key answer	27
AutoTalk.....	27

B

Banner	26
Base	
Installing	14
Multiple Bases.....	21
Parts of the base	8
Wall mounting	16

Battery

Battery life	47
Installing	13
Low battery alert.....	47
Replacement and handling	46

Belt clip.....	14
----------------	----

C

Caller ID.....	30
----------------	----

Deleting Caller ID records.....	31
Making calls from	30
Call screening.....	41, 44
Call waiting	31
Chain dialing.....	29
Conferencing	34

D

Day and time	40
--------------------	----

F

Finding a handset.....	33
------------------------	----

G

Greetings

Deleting	39
Recording.....	38
Selecting	39

H

Handset

Accessing the answering	
system.....	38
Accessory handsets	19
Banner.....	26
Choosing a ringer.....	27
Copying phonebook entries	25
Display and icons	9

Entering text.....	11
Finding	33
Parts of the handset.....	7
Registering.....	20, 21
Resetting	48
Standby screen	9

Hanging up	28
Headset	37
Hold	33

I

Insert 0.....	18
Installation	12
Intercom.....	35

K

Key touch tone.....	17
---------------------	----

M

Maintenance	46
Making calls.....	28
Using Caller ID	30
Using redial	31
Using the phonebook	29
Message alert.....	41, 44
Multiple Bases	21
Mute	
Microphone	36

Ringer..... 36

N

Name Tag 18

O

Out of range..... 49

P

Personal identification number
(PIN) 41

Personal ring 17

Phonebook 22

 Copying entries 25

 Creating new entries 22

 Deleting entries 24

 Editing entries 24

 Finding entries..... 23

 Making a call from 29

 Storing Caller ID or redial
 numbers 24

Privacy mode..... 35

R

Redial

 Deleting a record..... 32

 Making a calls with..... 31

Ringer

 Choosing a handset ringer 27

 Muting 36

 Personal ring..... 17

S

Safety notices 53

Screening calls 41, 44

Security code..... 41

Selecting the base 21

T

Text, entering 11

Transferring a call 34

V

Volume, adjusting 32

W

Wall mounting the base 16

Warranty 58

Remote Operation Card

CUT

REMOTE OPERATION CARD

Uniden®

Remote access away from home

1. Call your phone number from a touch-tone phone.
2. During the outgoing message, press # and enter your PIN code. The answering system announces the number of messages stored in memory and the voice prompts.
3. To quit, hang up the phone.

Turn on the answering system remotely

1. Call your phone and let it ring 15 times until you hear a beep.
2. Press # and then enter your PIN code.
3. Press # then 5 to stop the announcement.
4. Press # then 6 to turn the answering system on.

CUT

REMOTE OPERATION CARD

Uniden®

Remote access away from home

1. Call your phone number from a touch-tone phone.
2. During the outgoing message, press # and enter your PIN code. The answering system announces the number of messages stored in memory and the voice prompts.
3. To quit, hang up the phone.

Turn on the answering system remotely

1. Call your phone and let it ring 15 times until you hear a beep.
2. Press # and then enter your PIN code.
3. Press # then 5 to stop the announcement.
4. Press # then 6 to turn the answering system on.

CUT

REMOTE OPERATION CARD

Uniden®

Remote access away from home

1. Call your phone number from a touch-tone phone.
2. During the outgoing message, press # and enter your PIN code. The answering system announces the number of messages stored in memory and the voice prompts.
3. To quit, hang up the phone.

Turn on the answering system remotely

1. Call your phone and let it ring 15 times until you hear a beep.
2. Press # and then enter your PIN code.
3. Press # then 5 to stop the announcement.
4. Press # then 6 to turn the answering system on.

CUT

REMOTE OPERATION CARD

Uniden®

Remote access away from home

1. Call your phone number from a touch-tone phone.
2. During the outgoing message, press # and enter your PIN code. The answering system announces the number of messages stored in memory and the voice prompts.
3. To quit, hang up the phone.

Turn on the answering system remotely

1. Call your phone and let it ring 15 times until you hear a beep.
2. Press # and then enter your PIN code.
3. Press # then 5 to stop the announcement.
4. Press # then 6 to turn the answering system on.

Task	Key
Repeat a Message	#oper 1
Play Incoming Messages	#oper 2 abc
Skip a Message	#oper 3 def
Delete a Message	#oper 4 ghi
Stop Operation	#oper 5 jkl
Answering System On	#oper 6 mno
Answering System Off	#oper 9 wxyz
Help	# 0

Task	Key
Repeat a Message	#oper 1
Play Incoming Messages	#oper 2 abc
Skip a Message	#oper 3 def
Delete a Message	#oper 4 ghi
Stop Operation	#oper 5 jkl
Answering System On	#oper 6 mno
Answering System Off	#oper 9 wxyz
Help	# 0

Task	Key
Repeat a Message	#oper 1
Play Incoming Messages	#oper 2 abc
Skip a Message	#oper 3 def
Delete a Message	#oper 4 ghi
Stop Operation	#oper 5 jkl
Answering System On	#oper 6 mno
Answering System Off	#oper 9 wxyz
Help	# 0

Task	Key
Repeat a Message	#oper 1
Play Incoming Messages	#oper 2 abc
Skip a Message	#oper 3 def
Delete a Message	#oper 4 ghi
Stop Operation	#oper 5 jkl
Answering System On	#oper 6 mno
Answering System Off	#oper 9 wxyz
Help	# 0



ONE YEAR LIMITED WARRANTY

UNIDEN DECT 6035 and DECT 6035+1 CORDLESS PHONE

IMPORTANT : Evidence of original purchase is required for warranty service.

WARRANTOR : Uniden Australia Pty Limited A.B.N. 58 001 865 498
Uniden New Zealand Limited

Warranty only available in original country of purchase.

ELEMENT OF WARRANTY :

Uniden warrants to the original retail owner for the duration of this warranty, its UNIDEN DECT 6035 and DECT 6035+1 CORDLESS PHONE (herein after referred to as the Product), to be free from defects in materials and craftsmanship with only the limitations or exclusions set out below.

WARRANTY DURATION:

This warranty to the original retail owner only, shall terminate and be of no further effect ONE (1) year after the date of original retail sale. This warranty will be deemed invalid if the Product is;

- (A) Damaged or not maintained as reasonable and necessary,
- (B) Modified, altered or used as part of any conversion kits, subassemblies, or any configurations not sold by Uniden,
- (C) Improperly installed,
- (D) Repaired by someone other than an authorized Uniden Repair Agent for a defect or malfunction covered by this warranty,
- (E) Used in conjunction with any equipment or parts or as part of a system not manufactured by Uniden, or
- (F) Where the Serial Number label of the product has been removed or damaged beyond recognition.

Warranty only valid in the country of original retail/sale.

PARTS COVERED:

This warranty covers for one (1) year, the Product and included accessories.

STATEMENT OF REMEDY:

In the event that the Product does not conform to this warranty at any time while this warranty is in effect, the warrantor at its discretion, will repair the defect or replace the Product and return it to you without charge for parts or service. This warranty does not provide for reimbursement or payment of incidental or consequential damages.

This EXPRESS WARRANTY is in addition to and does not in any way affect your rights under the TRADE PRACTICES ACT 1974 (Cth) (Australia) or the CONSUMER GUARANTEES ACT (New Zealand).

PROCEDURE FOR OBTAINING PERFORMANCE OR WARRANTY:

In the event that the Product does not conform to this warranty, the Product should be shipped or delivered, freight pre-paid, with evidence of original purchase (e.g. a copy of the sales docket), to the warrantor at:

UNIDEN AUSTRALIA PTY LIMITED

SERVICE DIVISION

345 Princes Highway, Rockdale NSW 2216

Fx(02) 9599 3278

www.uniden.com.au

Customers in other States should ship or deliver the Product freight pre-paid to their nearest Uniden Authorized Repair Centre (Contact Uniden for the nearest Warranty Agent to you).

UNIDEN NEW ZEALAND LIMITED

SERVICE DIVISION

150 Harris Road, East Tamaki, Auckland

Fx(09) 274 4253

www.uniden.co.nz



Uniden®

© 2007
Uniden Australia Pty Limited
Uniden New Zealand Limited
Printed in China
UCZZ01903BZ(0)

Free Manuals Download Website

<http://myh66.com>

<http://usermanuals.us>

<http://www.somanuals.com>

<http://www.4manuals.cc>

<http://www.manual-lib.com>

<http://www.404manual.com>

<http://www.luxmanual.com>

<http://aubethermostatmanual.com>

Golf course search by state

<http://golfingnear.com>

Email search by domain

<http://emailbydomain.com>

Auto manuals search

<http://auto.somanuals.com>

TV manuals search

<http://tv.somanuals.com>