

Uniden®

UNIDEN
CORDLESS
TELEPHONES

DECT2085-4WX



Table of Contents

| | | | |
|--|-----------|--|-----------|
| Welcome | 5 | Entering Text from Your Phone | 20 |
| Accessibility | 5 | Basic Setup | 21 |
| What Exactly does “Waterproof Handset” Mean?.... | 5 | Selecting a Language | 21 |
| Installing the Phone | 6 | Activating Personal Ring (Handset only) | 22 |
| Choosing the Best Location | 6 | Activating the Key Touch Tone..... | 22 |
| Installing the Battery | 7 | Setting Up the Phonebook | 23 |
| Installing the Belt Clip | 8 | Creating Phonebook Entries..... | 23 |
| Connecting the AC adapter..... | 8 | Finding a Phonebook Entry | 24 |
| Charging the Handsets | 9 | Editing an Existing Phonebook Entry..... | 24 |
| Connecting to the Phone Line | 10 | Storing Caller ID or Redial Numbers in the Phonebook..... | 25 |
| Changing the Dial Mode | 11 | Deleting a Single Phonebook Entry | 25 |
| Wall Mounting the Base..... | 12 | Deleting all Phonebook Entries..... | 25 |
| Product Overview | 14 | Copying Phonebook Entries to Another Station..... | 26 |
| Features..... | 14 | Using the Voice Mail Service | 27 |
| Answering System Features | 14 | Resetting the Voice Message Waiting Indicator..... | 27 |
| Terminology Used in this Manual..... | 15 | Customizing Your Phone | 28 |
| Manual Conventions | 15 | Changing the Handset Banner (Handset only) | 28 |
| Parts of the Phone | 16 | Selecting a Ring Tone (Handset only)..... | 28 |
| Using the Interface | 18 | Activating AutoTalk (Handset only) | 29 |
| Reading the Display..... | 18 | Activating Any Key Answer (Handset only)..... | 29 |
| Using the Four-way Function Key..... | 19 | | |
| Using the Handset and Base Menus | 19 | | |

| | | | |
|---|-----------|---|-----------|
| Using Your Phone..... | 30 | Using Special Features..... | 39 |
| Making a Call from the Phonebook..... | 31 | Privacy Mode | 39 |
| Chain Dialing from the Phonebook..... | 31 | Using the Intercom..... | 39 |
| Switching to the Handset Speakerphone During a Call | 31 | Muting the Microphone | 40 |
| Using Caller ID, Call Waiting, and Redial Lists..... | 32 | Tone Dialing Switch Over..... | 40 |
| Using the Caller ID List | 32 | Installing the Optional Headset..... | 40 |
| Making a Call from a Caller ID Record | 32 | Setting Up the Answering System | 41 |
| Deleting Caller ID Numbers | 33 | Using Handset and Base Menus | 41 |
| Using Call Waiting..... | 34 | Handset Operation..... | 41 |
| Redialing a Number | 34 | Recording a Personal Greeting | 42 |
| Deleting a Redial Record..... | 34 | Selecting a Greeting | 42 |
| Adjusting the Ringer, Earpiece and Speaker Volume..... | 35 | Deleting Your Personal Greeting | 43 |
| Adjusting the Ringer Volume | 35 | Selecting the Language for Announcements | 43 |
| Muting the Ringer (One call only) | 35 | Setting the Number of Rings..... | 43 |
| Adjusting the Earpiece Volume..... | 35 | Setting the Day & Time (for Base) | 44 |
| Adjusting the Speaker Volume..... | 36 | Setting the Record Time (or Announce only) | 44 |
| Adjusting the Audio Tone (Handset only)..... | 36 | Activating the Message Alert | 45 |
| Finding a Lost Handset..... | 37 | Activating Call Screening on the Base..... | 45 |
| Using Hold, Conference and Transfer | 37 | Using the Answering System | 46 |
| Placing a Call on Hold | 37 | Turning Your Answering System On and Off | 46 |
| Conferencing | 37 | Reviewing Messages..... | 47 |
| Transferring a Call | 38 | Screening Calls..... | 48 |
| | | Turning Off the Message Alert Tone..... | 48 |
| | | Operating the Answering System While You Are Away from Home..... | 48 |

| | |
|---|-----------|
| Maintenance | 50 |
| Specifications..... | 50 |
| Battery Information | 50 |
| Power Failures | 52 |
| Troubleshooting | 53 |
| Common Issues..... | 53 |
| Resetting the Handset | 55 |
| Changing the Line Mode for Multiple Extensions .. | 57 |
| Traveling Out of Range..... | 57 |
| Liquid Damage..... | 58 |
| Precautions! | 59 |
| Rechargeable Nickel-Metal-Hydride Battery | |
| Warning | 59 |
| Important Safety Instructions | 59 |
| The FCC Wants You To Know | 60 |
| I.C. Notice | 61 |
| One Year Limited Warranty | 62 |
| Index | 63 |
| Remote Operation Card | 65 |

Welcome

Thank you for purchasing a Uniden Multi-Handset phone with a waterproof, floating handset.

Note: Illustrations in this manual are used for explanation purposes. Some illustrations in this manual may differ from the actual unit.

Accessibility

Uniden provides a customer service hotline for accessibility questions. If you have a disability and need customer service assistance or if you have any questions about how Uniden's products can accommodate persons with disabilities, please call the accessibility voice/TTY line: 1-800-874-9314.

Our customer care hours as well as accessibility information can be found on our website, www.uniden.com, under the "Accessibility" link. If your call is received outside of our business hours, you can leave us a message and we will call you back.

What Exactly does "Waterproof Handset" Mean?

The yellow handset complies with the JIS7 water submersion specifications. This means the handset can remain submerged under 3 feet of water for up to 30 minutes without damage or loss of functionality.

The handset will still receive calls even if it is under water, but you probably won't be able to hear the ringer. To avoid any accidents, **do not try to use the handset while it is still under water.**

Is the Charging Cradle Waterproof?

None of the charging cradles are waterproof. the yellow charging cradle is *water resistant*. The yellow cradle uses a special method called magnetic inductive charging, so it can charge your handset without exposing any electronic components. (You may notice that the charging contacts are enclosed in plastic and there is no metal showing.) This charging method makes the cradle safe to use near water or in highly humid environments, **but is it not designed to be submerged in water.**

Installing the Phone

Choosing the Best Location

When choosing a location for your new phone, here are some important guidelines you should consider:

PLACE YOUR BASE

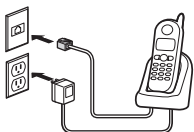

Near an AC outlet and a telephone wall jack.



In a centrally-located open area.

TRY TO AVOID

- Microwave ovens
- Refrigerators

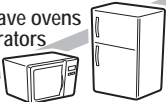

- Fluorescent lighting

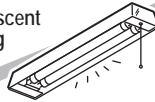

- Other cordless telephones



- TVs
- Other electronics



- Personal computers
- Wireless LAN equipment



- A window by a street with heavy traffic



- Direct sunlight
- Extreme temperatures



- Dust
- Excessive moisture



- Shock
- Vibration



Note: For maximum range:

- Keep both the base and handset antennas free of obstruction.
- When the handset is not in use, place the handset in an upright position.
- Metal and reinforced concrete may affect cordless telephone performance.

Installing the Battery

Use only the Uniden BT-1008 rechargeable battery pack supplied with your cordless telephone.

- 1 Press in on the handset battery case cover. Use the finger indentation for a better grip and slide the cover downward to remove.

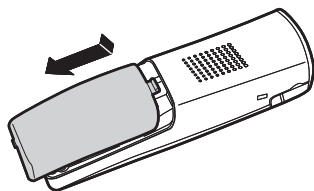

- 2 Plug the battery cable into the battery jack. Be sure to match the red and black wires to the label near the jack. The cable should snap into place.

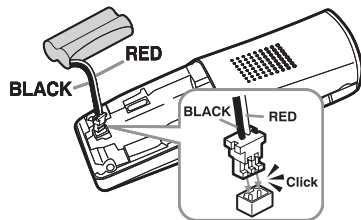

- 3 Replace the battery case cover back on the handset and slide it upwards until it clicks into place.

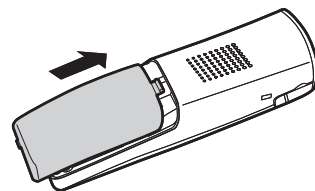

Gently pull on the battery cable. If the connector comes loose, try connecting again until the battery snaps into place.

Activating the waterproof handset

The waterproof handset's battery is already installed in the battery compartment, but you have to activate it before you charge it for the first time.

1. Push the activation pin located on the bottom of the handset (see the label with instructions).
2. Once you activate the handset, remove the label.

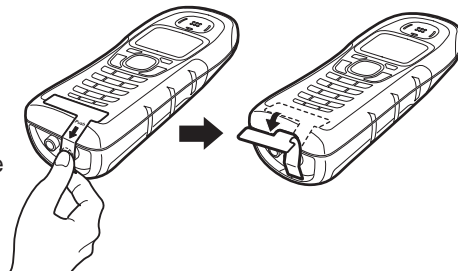

Installing the Belt Clip

Line up the holes on each side of the handset. To attach the belt clip, insert into the holes on each side of the handset. Press down until it clicks.

To remove the belt clip, pull either side of the belt clip to release the tabs from the holes.

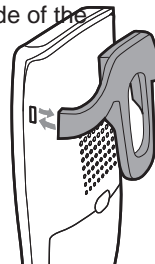

Connecting the AC adapter

Base

To avoid risk of fire and shock, only use the Uniden PS-0009 AC adapter supplied with your cordless telephone.

- A hand is shown plugging a yellow-tipped AC adapter into a jack on the back of the base. A line points from the text to the jack.

1 Connect the large, yellow-tipped AC adapter to the base's **DC IN 9V** jack.
- A close-up view of the back of the base showing a cord being routed through a channel. A line points from the text to the channel.

2 Route the cord inside the molded wiring channel.
- A hand is shown plugging the AC adapter into a standard wall outlet. A line points from the text to the outlet.

3 Connect the AC adapter to a standard 120V AC wall outlet. **DO NOT** use an AC outlet controlled by a wall switch.

Charger

Use only the Uniden AC adapters supplied with your phone.

- 1 Connect the smallest AC adapter (labeled **PS-0011**) to the yellow charger's **DC IN 19V** jack.

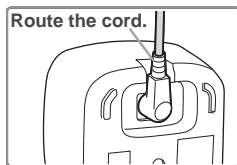

Then, connect each of the remaining AC adapters (**PS-0007**) to a regular charger's **DC IN 9V** jack.

- 2 Connect each AC adapter to a standard 120V AC wall outlet. **DO NOT** use an AC outlet controlled by a wall switch.

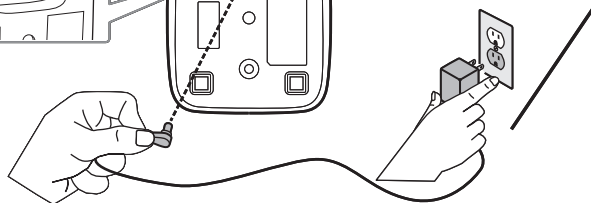

Charging the Handsets

- 1 Place one handset in the base and the others in the charging cradles with the handset display facing forward.
(The waterproof handset goes in the yellow charging cradle; for the other handsets, it doesn't matter which one goes in the base and which ones go in the charging cradles.)

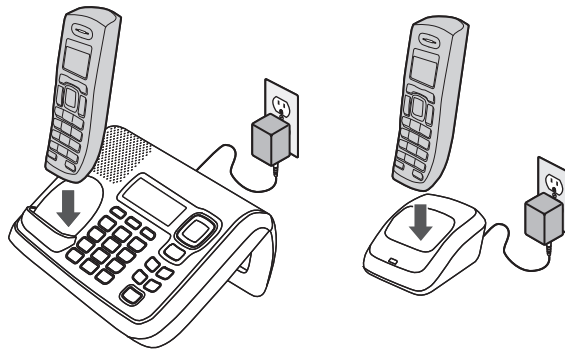

- ② Charge your handsets completely before plugging in the phone line. The waterproof handset need to charge for about 25 hours the first time; the others only need about 15-20 hours.

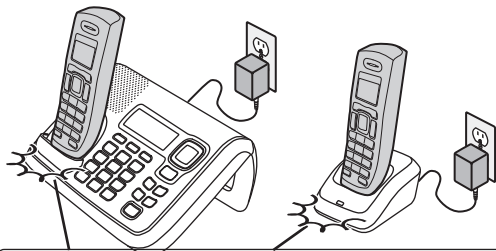

Make sure that the **charge** LED illuminates.

? What if the **charge** LED doesn't light up?



- Check the AC adapter connection.
- Reset the handset to make sure it makes good contact with the charging contacts.

Connecting to the Phone Line

Make sure that the battery pack is fully charged.

- ① Connect the telephone cord to the **TEL LINE** jack.

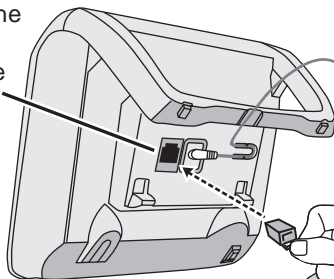

- ② Connect the telephone cord to a telephone wall jack.

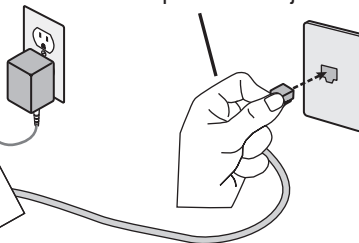

? What if CHECK TEL LINE appears on the base display?



The telephone cord may not be connected correctly. Check the telephone cord connection.

DSL Filter

? Do you have DSL or any high-speed Internet service delivered through your phone line?

💡 Try putting a DSL filter between the base and the wall jack. Without a filter, telephone-line-based Internet services can interfere with standard phones.

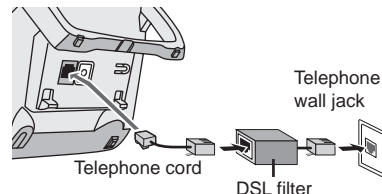

Testing the Connection

Try making a call. If your call does not connect or you cannot get a dial tone, try the following steps:

1. Make sure the AC adapter cord is securely connected to the **DC IN 9V** jack and a standard power outlet.
2. Check to make sure the battery is fully charged. (If you don't see the "battery full" icon, check to make sure the battery is properly connected and charge again.)
3. Change the dial mode.

Changing the Dial Mode

Your phone can communicate with the telephone network in two different ways: tone dialing or pulse dialing. These days, most base networks use a method called tone dialing, so your phone comes programmed for tone dialing. If your phone company uses pulse dialing, you will need to change your phone's dial mode. If you don't get a dial tone or can't connect to the telephone network, please follow the steps below to modify your phone's settings:

1. Press **[Menu/Select]**. Select the GLOBAL SETUP menu, and then the DIAL MODE submenu.
2. Scroll **[▼]** to highlight PULSE.
3. Press **[Menu/Select]**. You will hear a confirmation tone.

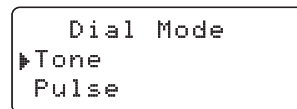

If you ever need to change the dial mode back to tone dialing, follow the same procedure, but select TONE in step 2.

NOW YOU ARE READY TO USE YOUR PHONE!

Wall Mounting the Base

This phone can be mounted on any standard wall plate.

- ① Insert the two hooks on the wall mount adapter into the holes on the upper rear of the base. Slide the adapter up as far as it will go (about 1/4 of an inch).

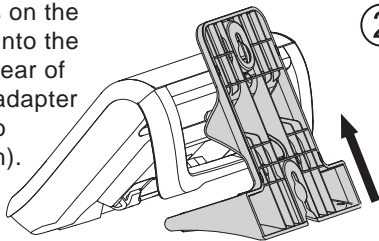

- ② Gently press in on the tabs at the bottom of the adapter. Slide the bars under the hooks on the base.

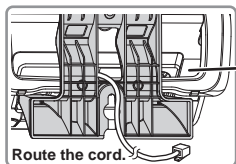
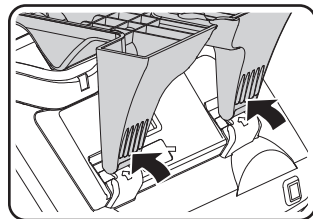

- ③ Connect the telephone cord into the **TEL LINE** jack.

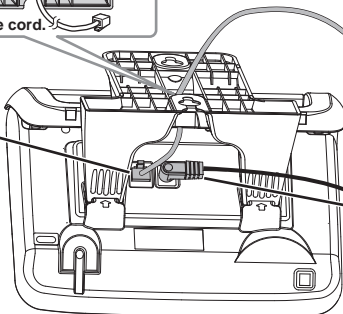

- ④ Route the telephone cord through the hole of the wall mount adapter, and plug the telephone cord into the telephone wall jack.

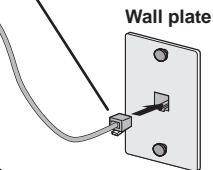

- ⑤ Connect the AC adapter to the **DC IN 9V** jack and let the cord hang below the wall mount adapter.



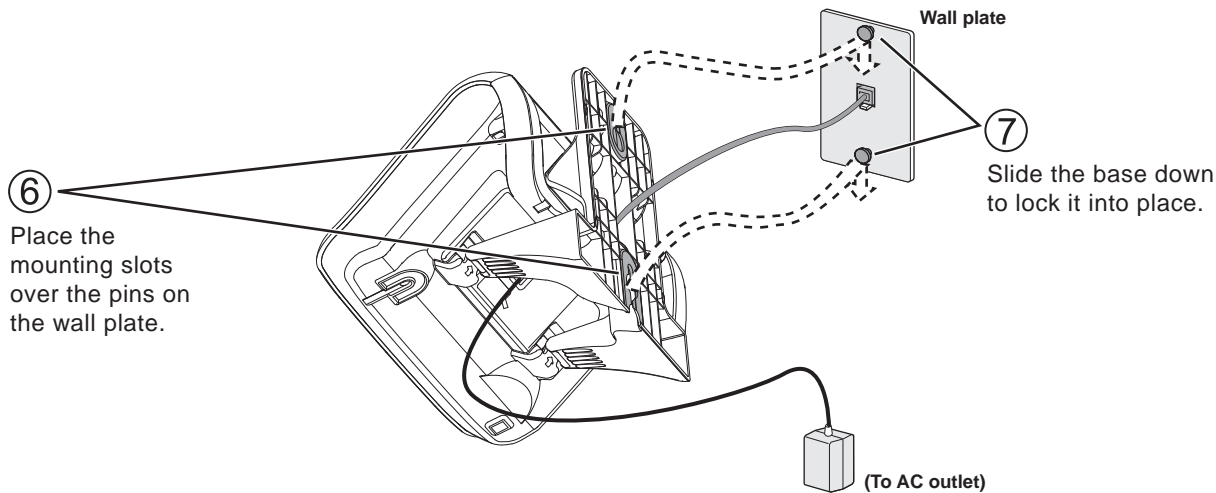

Notes:

- DO NOT use an AC outlet controlled by a wall switch.
- To mount the phone directly on the wall, insert two #10 screws (minimum length of $1 \frac{3}{8}$ inches, not supplied) into the wall, $3 \frac{15}{16}$ inches apart; leave the screw heads $\frac{1}{8}$ inch away from the wall to allow room for mounting the phone. Be sure the wall is capable of supporting the weight of the phone, and use the proper type of anchoring device for the wall material. No need to route the telephone cord through the hole of the wall mount adapter when mounting directly on the wall.

Product Overview

Features

- 1.9GHz DECT6.0 System
- Floating, waterproof handset included
- Integrated Digital Answering System
- Caller ID/Call Waiting
- Base Keypad
- Advanced Phonebook Features:
 - Store 70 Phonebook Entries on Base & each Handset
 - Alphabetical Search
 - Personalized Ring by Party (on Handset)
 - Transfer Single Listing or Entire Phonebook
- Store 30 Caller ID Numbers on Base & each Handset
- Speakerphone on Base & Handset
- 7 Ringer Options on Handset (3 Tones/4 Melodies)
- Last 5 Number Redial
- Bilingual Menu Displays
(for US models: English and Spanish,
for Canadian models: English and French)
- Call Transfer
- Conferencing
- Intercom

Answering System Features

- Digital Tapeless Recording
- Up to 14 Minutes of Recording Time
- Call Screening
- Personal or Pre-recorded Outgoing Messages
- Bilingual Voice Prompts
(for US models: English and Spanish,
for Canadian models: English and French)
- Day and Time Announcement
- Remote Message Retrieval
- Toll Saver
- Message Alert
- Records Up to 59 messages

Terminology Used in this Manual

| | |
|------------------------|--|
| Standby | The handset and the base are not in use. If the handset is on the cradle or [flash] or [speaker] on the handset or [speaker] on the base is not pressed, no line has been activated. No dial tone is present. |
| CID | Caller ID is available from your Telephone provider and is offered to users on a subscription basis. With this service, you will be able to see the incoming caller information such as name and phone number. |
| CID/CW or CIDCW | Caller ID with Call Waiting is available by subscription from your Telephone provider. With this service, you will be able to view incoming caller information while on a call with another user. |
| Base | The main part of the phone that connects to your phone line and lets you make and receive calls. |
| Charger | A cradle that charges the handset battery. It connects to power but does not connect to a phone line. |
| Global Settings | This term relates to feature settings that will apply to all registered handsets and the base. These features are available by selecting "GLOBAL SETUP" in the handset or the base menu. Only one handset or the base can change global settings at a time, and you have to make sure the phone is not currently being used. |
| Station | Any handset or the base. |
| Talk | A telephone line has been activated on the handset or base, enabling a dial tone. |

Manual Conventions

This manual uses several different type styles to help you distinguish between different parts of the phone:

- **Bold** text with "[]" indicates a key or button on the phone
- ALL CAPITALS indicates text on the display, such as menu options, prompts, and confirmation messages
- **lower case bold** text indicates a status light on the phone
- **ALL CAPITALS BOLD** indicates a connection jack on the base or charger

Parts of the Phone

The following illustrations show you all of the different parts of your phone.

Handset

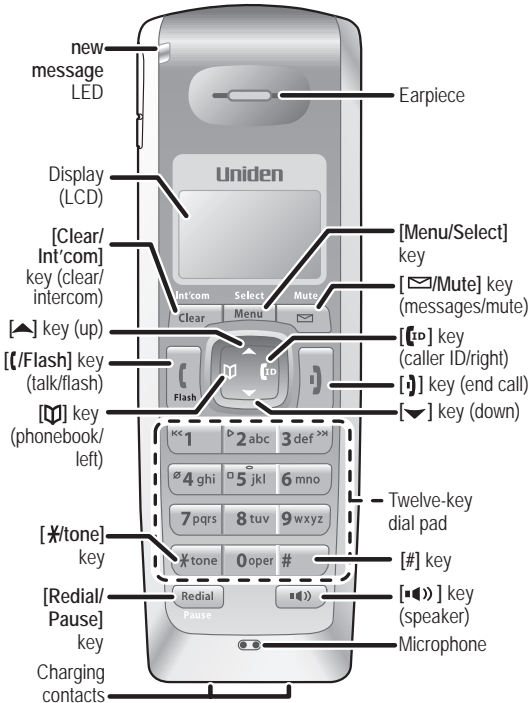

Waterproof handset

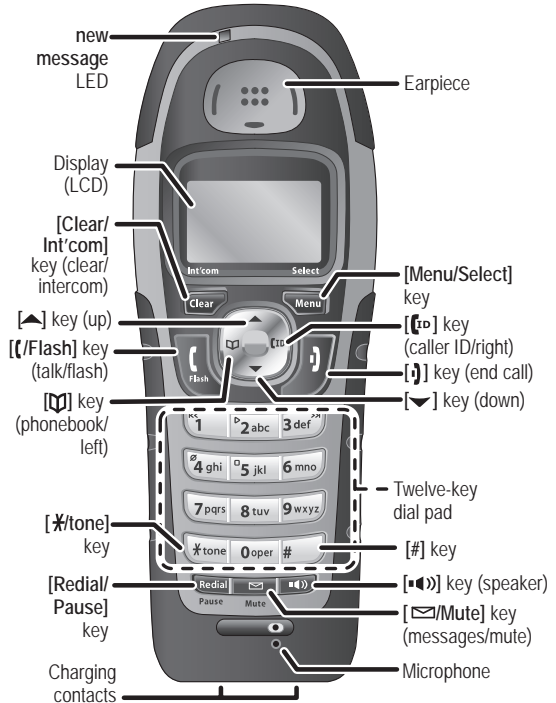

Base

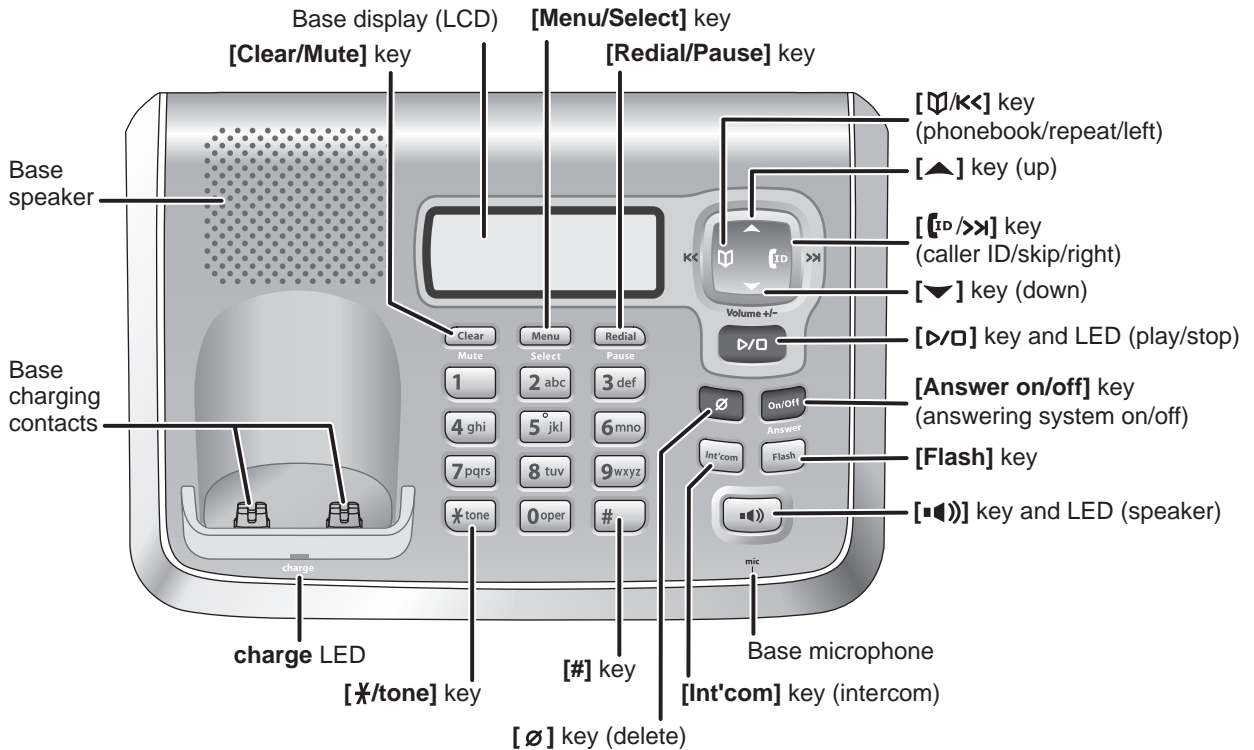

Using the Interface

Reading the Display

Handset

In standby

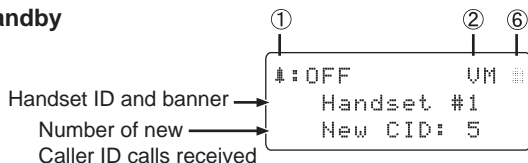

During a call

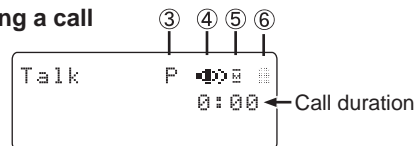

Base

In standby

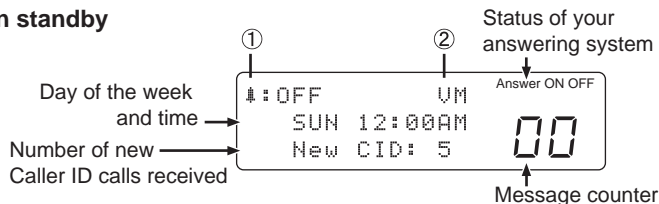

During a call

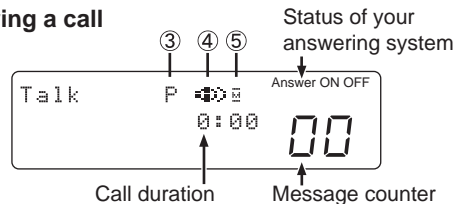

| | | |
|---|---------|---|
| ① | # : OFF | The ringer off icon indicates that the ringer is turned off. |
| ② | UM | The voice mail icon appears when you have messages waiting in your voice mailbox. |
| ③ | P | The privacy icon appears when the Privacy Mode is turned on. |
| ④ | 🔊 | The speaker icon appears when the speaker phone is in use. |
| ⑤ | 🔇 | The mute icon appears while the microphone is muted. |
| ⑥ | 🔋 | The battery icon indicates the handset battery status: full, medium, low, and empty. |

Using the Four-way Function Key

Your handset and base have a four-way function key that allows you to move the cursor or pointer on the display and access the most commonly used features at the touch of a button. By moving this key to the left, you open the phonebook. Move the key to the right to access Caller ID information. To use this four-way key, place your thumb over the key on the station and move to the four positions to get the feel of how it moves and operates.

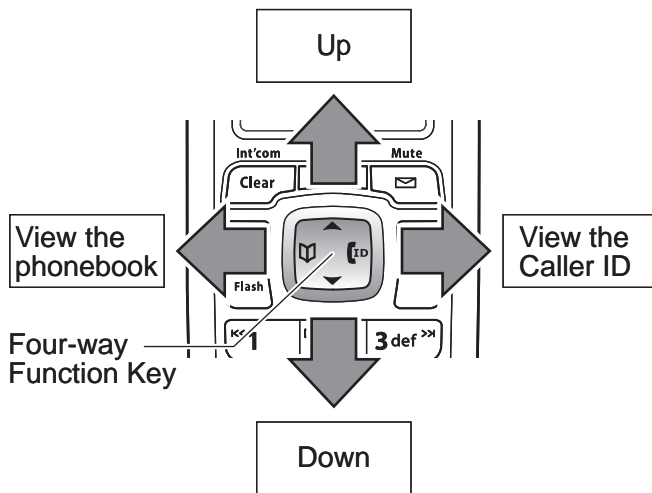

Using the Handset and Base Menus

To open the menu, press **[Menu/Select]**. Highlight the option you want by pressing the four-way function key. This will move the cursor; the option currently highlighted has a triangle beside it. Activate the highlighted option by pressing **[Menu/Select]**. To go back to the previous screen, press **[left]** on the four-way function key. To exit the menu and return to standby, press **[j]** on the handset or **[▷/◁]** on the base.

If you do not press a key within thirty seconds, the phone will time out and exit the menu. When setting the day and time, the time-out period is extended to two minutes.

Note: For ANSW. SETUP, GLOBAL SETUP, DAY & TIME and REGISTER HANDSET (base only) menu options, make sure the line is not in use and the handsets are within range of the base.

Entering Text from Your Phone

You can use the number keypad on your handset or base to enter text by referring to the letters printed on each number key. When you press the number key in a text entry field, the phone displays the first letter printed on the number key. Press the number key twice to display the second letter and three times to display the third. Capital letters are displayed first, then lower case letters, and then the number on the key.

If two letters in a row use the same number key, enter the first letter, then use **[right]** on the four-way function key to move the cursor to the next position to enter the second letter.

For example, to enter the word "Movies":

- 1) Press **[6]** once to enter *M*.
- 2) Use **[right]** on the four-way function key to move the cursor to the right.
- 3) Press **[6]** six times to enter *o*.
- 4) Press **[8]** six times to enter *v*.
- 5) Press **[4]** six times to enter *i*.
- 6) Press **[3]** five times to enter *e*.
- 7) Press **[7]** eight times to enter *s*.
- 8) Press **[Menu/Select]** to end your text entry.

If you make a mistake while entering a name, use **[right]** or **[left]** on the four-way function key to move the cursor to the incorrect character. Press **[Clear/Int'com]** on the handset or **[Clear/Mute]** on the base

to erase the wrong character, and then enter the correct character. To delete all characters, press and hold **[Clear/Int'com]** on the handset or **[Clear/Mute]** on the base.

Note: When you enter the text on the handset, you can also use **[#]** to move the cursor to right and **[*/tone]** to move the cursor to left.

| | Number of times key is pressed | | | | | | | | |
|---------------|--------------------------------|---|---|---|---|---|---------|----|----|
| keys | 1 | 2 | 3 | 4 | 5 | 6 | 7 | 8 | 9 |
| 1 | 1 | | | | | | | | |
| 2 abc | A | B | C | a | b | c | 2 | | |
| 3 def | D | E | F | d | e | f | 3 | | |
| 4 ghi | G | H | I | g | h | i | 4 | | |
| 5 jkl | J | K | L | j | k | l | 5 | | |
| 6 mno | M | N | O | m | n | o | 6 | | |
| 7 pqrs | P | Q | R | S | P | q | r | s | 7 |
| 8 tuv | T | U | V | t | u | v | 8 | | |
| 9 wxyz | W | X | Y | Z | w | x | y | z | 9 |
| 0 oper | & | (|) | < | > | / | (blank) | -- | -- |
| | . | , | : | ? | ! | @ | ' | " | * |
| | # | 0 | | | | | | | |

Basic Setup

Selecting a Language

Each station supports two languages: English and Spanish for US models or English and French for Canadian models. Once you select a language, the menus on the station will display in that language. The default language is English.

- 1) Press **[Menu/Select]**.
Select the **HANDSET SETUP** or **BASE SETUP** menu, and then the **HANDSET LANGUAGE** or **BASE LANGUAGE** submenu.
- 2) Move the cursor to choose a language.
for US models:
Choose **ENGLISH** or **ESPAÑOL** (Spanish).
for Canadian models:
Choose **ENGLISH** or **FRANÇAIS** (French).
- 3) Press **[Menu/Select]**.
You will hear a confirmation tone.

```
Handset Language
▶English
Español
```

```
Base Language
▶English
Español
```

for US models

```
Handset Language
▶English
Français
```

```
Base Language
▶English
Français
```

for Canadian models

Activating Personal Ring (Handset only)

You can assign special ringer tones to anyone in your phonebook. When your phone gets a call, it looks up the Caller ID information in your phonebook. If you've assigned a personal ringer to that number, the phone uses it so you know who is calling. To turn the personal ringing on or off, follow these steps:

- 1) Press **[Menu/Select]**. Select the HANDSET SETUP menu, and then the PERSONAL RING submenu.
- 2) Move the cursor to select ON or OFF.
- 3) Press **[Menu/Select]**. You will hear a confirmation tone.

```
Personal Ring
▶ On
  Off
```

Activating the Key Touch Tone

Key Touch Tone is the tone your keypad makes when keys are pressed. You can turn this tone on or off.

- 1) Press **[Menu/Select]**. Select the HANDSET SETUP or BASE SETUP menu, and then the KEY TOUCH TONE submenu.
- 2) Move the cursor to select ON or OFF.
- 3) Press **[Menu/Select]**. You will hear a confirmation tone.

```
Key Touch Tone
▶ On
  Off
```

Setting Up the Phonebook

Your handset and base can store up to seventy names and numbers in your phonebook. When all the phonebook entries are full, you will hear a beep and MEMORY FULL appears. You cannot store any additional names and numbers unless you delete some of the existing ones.

You can also use the phonebook entries to store a group of numbers (up to twenty digits) that you may need to enter once your call connects. This is referred to as chain dialing. See Chain Dialing from the Phonebook on page 31.

Creating Phonebook Entries

To store names and numbers in your phonebook, please follow these steps:

- 1) When the phone is in standby mode, press [] (on the left side of the four-way key).
- 2) To create a new phonebook entry, press [Menu/Select]. Select the CREATE NEW menu. EDIT NAME appears.

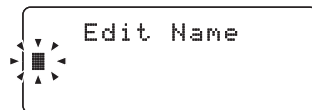

- 3) **Enter the name for this entry (EDIT NAME).**

Use the keypad to enter a name for this entry; the name can contain up to sixteen characters. (See Entering Text from Your Phone on page 20 for instructions on entering text.) If you do not want to enter a name for this entry, your phone will store this entry as <NO NAME>. Press [Menu/Select] when you are finished.

- 4) **Enter the number for this entry (EDIT NUMBER).**

Once you have stored a name, EDIT NUMBER appears next. Use the number keypad to enter the phone number; the phone number can contain up to twenty digits. If you need the phone to pause between digits when it's dialing (for example, to enter an extension or an access code), press [Redial/Pause] to insert a two-second pause. You will see a P in the display. You can also use more than one pause together if two seconds is not long enough. Each pause counts as one digit. Press [Menu/Select] when you are finished.

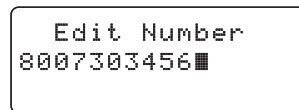

5) Assign a personal ring tone for this entry (PERSONAL RING) (Handset only).

You can attach a special ring tone to each phonebook entry on the handsets; the phone will use this ring tone when this person calls. Use [▲] and [▼] to select one of the seven different ring tone options (see Selecting a Ring Tone on page 28 for a complete list of ring tones). As you scroll through the tones, you will hear a sample of each tone (unless the handset ringer volume is set to off). When you hear the ring tone you want to use, press [Menu/Select]. If you do not want to use a personal ring tone for this phonebook entry, choose NO SELECTION; the phone will use your standard ring tone setting.

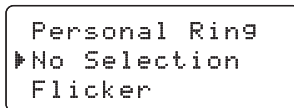

6) You will hear a tone confirming that the new entry has been stored, and DONE! appears in the display.

Finding a Phonebook Entry

Press [Ⓜ] to open the phonebook. Phonebook entries are stored in alphabetical order. To scroll through the phonebook from A to Z, press [▼]. To scroll through the phonebook from Z to A press [▲].

You can also use the letters on the number keys to jump to a name that starts with that letter. For example, to search for an entry beginning with the letter M, press [6] once. The phonebook jumps to the first entry that begins with the letter you entered; you can then use [▲] and [▼] to scroll to other entries.

To close the phonebook and return to standby, press [Ⓜ] on the handset or [▷/◻] on the base. If you are looking up a phonebook entry during a call and want to close the phonebook, press [Ⓜ] again instead of [Ⓜ] or [▷/◻].

Editing an Existing Phonebook Entry

- 1) When the phone is in standby, press [Ⓜ] to open the phonebook.
- 2) Find the entry you want to edit and press [Menu/Select].
- 3) Select EDIT. Follow the steps for Creating Phonebook Entries on page 23. If you do not wish to change the information at any step, simply press [Menu/Select] to go to the next step.

Storing Caller ID or Redial Numbers in the Phonebook

You can store Caller ID records or redial numbers in the phonebook so you can use them later. Go to the Caller ID or redial list and select the number you want to store. (If the Caller ID information did not include the number, then you will not be able to store it.)

- 1) When the phone is in standby, press **[☎]** to open the Caller ID list or **[Redial/Pause]** to open the redial list.
- 2) Use **[▲]** and **[▼]** to scroll through the Caller ID records or redial numbers. When you come to the information you want to store, press **[Menu/Select]**.
- 3) Select STORE INTO PB. EDIT NAME appears. If the phone number is already stored in memory, you will hear a beep, and THIS DATA IS ALREADY SAVED! appears in the display. The number will not be stored.
- 4) Continue by following the steps for Creating Phonebook Entries on page 23.

Deleting a Single Phonebook Entry

- 1) When the phone is in standby, press **[M]**.
- 2) Find the entry that you want to delete and press **[Menu/Select]**.
- 3) Select DELETE. DELETE ENTRY? appears in the display.
- 4) Move the cursor to select YES.
- 5) Press **[Menu/Select]**. You will hear a confirmation tone, and DELETED! appears in the display.



```
Edit
Copy
▶Delete
```

Deleting all Phonebook Entries

- 1) When the phone is in standby, press **[M]**.
- 2) Press **[Menu/Select]**, and then select DELETE ALL. DELETE ALL? appears in the display.
- 3) Move the cursor to select YES.
- 4) Press **[Menu/Select]**. You will hear a confirmation tone, and DELETED! appears in the display.

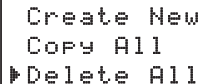

```
Create New
Copy All
▶Delete All
```

Copying Phonebook Entries to Another Station

You can transfer phonebook entries from one station to another without having to re-enter names and numbers. You can transfer one phonebook entry at a time or all phonebook entries at once.

- 1) When the phone is in standby, press [**⏏**].
- 2) To copy one entry, find the phonebook entry you want to copy. Press [**Menu/Select**], and then select COPY. To copy all entries, press [**Menu/Select**], and then select COPY ALL.
- 3) Move the cursor to select the station which you want to transfer the entries to and then press [**Menu/Select**]. If you select COPY ALL, ARE YOU SURE? appears on the display screen. Move the cursor to select YES, and then press [**Menu/Select**].
- 4) The phonebook entries will be transferred to the designated station. During the copy process, the receiving station shows RECEIVING and the ID of the sending station.
- 5) When the transfer is completed, DONE! appears on the station.

Note: If your phonebook contains seventy entries, you cannot store any new phonebook entries. You will hear a beep, and NOT ENOUGH MEMORY IN RECEIVING UNIT appears on the display. If the selected station is out of range or data transfer is cancelled, UNAVAILABLE appears in the display. Phonebook listings will not be transferred.

Using the Voice Mail Service

If you subscribe to a voice mail service, you can use your phone to access your voice mailbox. The **new message** LED on the handset flashes and  appears in the handset and base display whenever you have messages waiting in your voice mailbox. When you subscribe to the service, your voice mail provider provides you with the access number and the required voice mail signaling tone. You can use your phonebook to store the access number.

Resetting the Voice Message Waiting Indicator

When you receive a new voice mail message, the **new message** LED on the top of the handset flashes and  appears in the handset and base display. In the event your message alert tone gets out of sync with your phone company's voice messaging system, you can reset back to its original "no messages waiting" state.

- 1) On the base, press **[Menu/Select]**. Select the GLOBAL SETUP menu, and then the VMWI RESET submenu.
- 2) Move the cursor to select YES or NO.
- 3) Press **[Menu/Select]**. You will hear a confirmation tone.

Customizing Your Phone

Changing the Handset Banner (Handset only)

Each handset will display a banner name once it is registered to the base. The default banner is Handset #1, Handset #2, etc. You can change the name your phone displays by changing the banner display. If you have more than one handset, the banner name identifies your handset.

- 1) Press **[Menu/Select]**. Select the HANDSET SETUP menu, and then the BANNER submenu.
- 2) Use the keypad to enter or edit the banner name. (See Entering Text from Your Phone on page 20 for detailed instructions on entering text.)
- 3) Press **[Menu/Select]**. You will hear a confirmation tone.

Selecting a Ring Tone (Handset only)

You may choose from four melodies or three tones for your phone's primary ring tone. Each handset can use a different ring tone or melody. The available ring tones are as listed:

- 1) Press **[Menu/Select]**. Select the HANDSET SETUP menu, and then the RINGER TONES submenu.
- 2) Move the cursor to select a ring tone. As each ring tone is highlighted, you will hear a sample (unless the handset ringer volume is set to off).
- 3) When you hear the tone you want to use, press **[Menu/Select]**. You will hear a confirmation tone.

| Melodies | Tones | |
|-----------------------------------|--|---------|
| | Fur Elise (ELISE) | Flicker |
| | We Wish You A Merry Christmas (MERRY-XMAS) | Clatter |
| | Aura Lee (AURA LEE) | Wake Up |
| Star Spangled Banner (STAR SPNGL) | | |

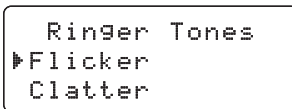

Activating AutoTalk (Handset only)

AutoTalk allows you to answer the phone simply by picking up the handset from the cradle. You do not have to press a button to answer the call.

- 1) Press **[Menu/Select]**. Select the HANDSET SETUP menu, and then the AUTOTALK submenu.
- 2) Move the cursor to select ON or OFF.
- 3) Press **[Menu/Select]**. You will hear a confirmation tone.

```
AutoTalk
On
▶ Off
```

Activating Any Key Answer (Handset only)

Any Key Answer allows you to answer the phone by pressing any key on the dial pad.





- 1) Press **[Menu/Select]**. Select the HANDSET SETUP menu, and then the ANY KEY ANSWER submenu.
- 2) Move the cursor to select ON or OFF.
- 3) Press **[Menu/Select]**. You will hear a confirmation tone.



```
Any Key Answer
On
▶ Off
```

Using Your Phone

| | From the base speakerphone | From a cordless handset | From a handset speakerphone |
|-------------------------|--|--|--|
| Making a call | 1) Press [MUTE] . 2) Listen for the dial tone. 3) Dial the number. OR 1) Dial the Number. 2) Press [MUTE] . | 1) Pick up the handset from the cradle. 2) Press [FLASH] . 3) Listen for the dial tone. 4) Dial the number. OR 1) Pick up the handset from the cradle. 2) Dial the number. 3) Press [FLASH] . | 1) Pick up the handset from the cradle. 2) Press [MUTE] . 3) Listen for the dial tone. 4) Dial the number. OR 1) Pick up the handset from the cradle. 2) Dial the number. 3) Press [MUTE] . |
| Answering a call | Press [MUTE] . | 1) Pick up the handset. (If AutoTalk is on, the phone will answer when you pick up the handset from the cradle.) 2) Press [FLASH] . (If Any Key Answer is on, you can also press any key on the dial pad.) | 1) Pick up the handset. 2) Press [MUTE] . |
| Hanging up | Press [MUTE] . | Press [END] or return the handset to the cradle. | |



Making a Call from the Phonebook

- 1) When the phone is in standby, press [] to open the phonebook.
- 2) Find the phonebook entry you want to call (see Finding a Phonebook Entry on page 24).
- 3) Press [ /Flash] or [] on the handset or [] on the base to dial the number.



Note: You can also press [ /Flash] or [] on the handset or [] on the base before you open the phonebook. When you come to the phone number you want to dial, press [**Menu/Select**].

Chain Dialing from the Phonebook

If you often have to enter a series of digits or some type of code number during a call, you can save that code number to a phonebook entry. When your call connects, just use the phonebook to transmit the saved code number. (This is referred to as chain dialing.)

- 1) Enter the code number (up to twenty digits) into the phonebook (see Creating Phonebook Entries on page 23). Be sure to enter the code number into the phonebook exactly as you would enter it during a call.
- 2) During a call, when you hear the prompt that tells you to enter the code number, press [].
- 3) Use [] or [] to select the phonebook entry that contains the digits you want to send.
- 4) Press [**Menu/Select**]. The phone sends the digits of the code number exactly as you saved them in the phonebook entry.

Switching to the Handset Speakerphone During a Call

To switch a normal call to the speakerphone, press [] on the handset. To switch from a speakerphone call to a normal call, press [].

Using Caller ID, Call Waiting, and Redial Lists

If you subscribe to Caller ID service from your phone company, your phone will show you the caller's phone number and name (if available) whenever a call comes in. If you subscribe to Caller ID on Call Waiting, the phone will also show you the name and the number of any call that comes in while you're on the line.

Using the Caller ID List

You can store up to thirty Caller ID numbers in each station. Caller ID records are stored from newest to oldest. Once your Caller ID list is full, the oldest record will be automatically deleted when a new call is received.

To open the Caller ID list, press **[*1]** (on the right side of the four-way key). The phone will show the number of new Caller ID records (that is, records you have not reviewed yet) and the total number of stored records. Use **[▲]** and **[▼]** to scroll through the list.

```

Caller ID
New : 1
Total:30
  
```

```

12/21 12:00PM
Jane Smith
214-555-1234
  
```

Making a Call from a Caller ID Record

- 1) When the phone is in standby, press **[*1]** to open the Caller ID list.
- 2) Use **[▲]** and **[▼]** to find the Caller ID record you want to dial.
- 3) If you need to add (or delete) a "1" to the beginning of the displayed phone number, press **[*/tone]**. If you need to add (or delete) the stored area code, press **[#]**.
- 4) Press **[*/Flash]** or **[*1]** on the handset or **[*1]** on the base to dial the number.

Note: You can also press **[*/Flash]** or **[*1]** on the handset or **[*1]** on the base before you open the caller ID list. When you come to the phone number you want to dial, press **[Menu/Select]**.



What's This "Add or Delete a 1" About?



- Any phone number in the Caller ID records might (or might not!) have a "1" at the front, depending on how different phone companies send the Caller ID information.
- The phone dials the number exactly as it appears in the Caller ID record.

- If the phone number is a long distance or toll call, but the Caller ID record does not have a “1” in front of the number, press **[*/tone]** to add it.
- If the phone number is a local or non-toll call, but the Caller ID record has a “1” in front of the number, press **[*/tone]** to delete it.

Seven-Digit Dialing

If you can make a local call by dialing only seven digits instead of ten, you can tell the phone to hide your local area code in the Caller ID list; any calls from outside your area code will show all ten digits.

To program your local area code:

- 1) Press **[Menu/Select]**. Select the GLOBAL SETUP menu, and then the AREA CODE submenu.
- 2) Use the number keypad (**[0]** through **[9]**) to enter a three-digit area code. If an area code has already been stored, it appears in the display. Press **[Clear/Int'com]** on the handset or **[Clear/Mute]** on the base to delete the stored code, and then enter a new one.
- 3) Press **[Menu/Select]**. You will hear a confirmation tone. The setting applies to all registered handsets and the base.

The phone uses the stored area code as a filter. When a call comes in, the phone compares the incoming area code to the code programmed on the phone. If the two codes match, the station hides the area code in the Caller ID list.

When you are viewing a Caller ID record, you can show the hidden area code by pressing **[#]**. Press **[#]** again to hide the area code. When you dial from a Caller ID record or store a Caller ID record in the phonebook, the phone dials or stores the digits exactly as they appear on the display. If you need to use ten digits, be sure to press **[#]** to show the area code before you dial or store the number. See page 25 to store a Caller ID record in the phonebook.

Deleting Caller ID Numbers

To delete only one Caller ID number, press **[*1]** when the phone is in standby, and then find the number you want to delete. Press **[Menu/Select]** and select DELETE ENTRY. When the phone asks you to confirm, select YES.

To delete all the Caller ID numbers, press **[*1]** when the phone is in standby, and then press **[Menu/Select]**. When the phone asks you to confirm, select YES.

Notes: • When you delete a Caller ID number, you delete it permanently.

- Caller ID numbers are stored separately in each station. Deleting a record from one station will not delete the record from any other stations.

Using Call Waiting

If you have Call Waiting service and a second call comes in when you are on the phone, a call waiting tone will sound. Press **[Flash]** on the handset or **[Flash]** on the base to accept the waiting call. There is a short pause, and then you will hear the new caller. To return to the original caller, press **[Flash]** on the handset or **[Flash]** on the base.

Note: You must subscribe to Call Waiting service for this feature to operate. Not all features are available in all areas.

Redialing a Number

You can quickly redial the last five numbers dialed on each station.

- 1) When the phone is in standby, press the **[Redial/Pause]** to open the redial list.
- 2) Use **[▲]** and **[▼]** or **[Redial/Pause]** to scroll through the redial list.
- 3) When you find the number you want to dial, press **[Flash]** or **[▶▶]** on the handset or **[▶▶]** on the base.

Notes: • If the number exceeds 32 digits, only the first 32 digits are retained in redial memory.

- If the redial memory is empty, EMPTY appears in the display and you will hear a beep.
- You can also press **[Flash]** or **[▶▶]** on the handset or **[▶▶]** on the base before you open the redial list. When you come to the phone number you want to dial, press **[Menu/Select]**.

Deleting a Redial Record

If you want to delete a phone number from the redial list, follow the steps below:

- 1) When the phone is in standby, press **[Redial/Pause]**.
- 2) Use **[▲]** and **[▼]** to scroll through the redial list.
- 3) When you find the redial number you want to delete, press **[Menu/Select]** and select DELETE ENTRY.
- 4) When the phone asks you to confirm, select YES. The redial number is deleted.

Adjusting the Ringer, Earpiece and Speaker Volume

Adjusting the Ringer Volume

You can choose from four ringer volume settings (off, low, medium, and high) separately on each handset or the base.

- 1) With the phone in standby, press [**▲**] or [**▼**]. The display shows the current volume level and the station sounds the ringer at that level.
- 2) Use [**▲**] to make the ringer volume louder or [**▼**] to make it softer or turn it completely off.
- 3) When you hear the ringer volume level you want to use, stop pressing keys. The station will use the new ringer volume starting with the next incoming call.

Note: If you set the ringer volume to OFF, the station won't ring. The other stations will ring according to their individual settings.

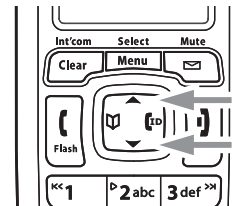

Muting the Ringer (One call only)

While the phone is ringing, press [**Envelope/Mute**] or [**i**] on the handset, or [**Clear/Mute**] or [**▶/□**] on the base to mute the ringer for this call. The phone will ring again on the next call.

Adjusting the Earpiece Volume

You can choose from six volume levels for the handset earpiece. To adjust the earpiece volume while on a call, press [**▲**] (to make it louder) or [**▼**] (to make it softer). The handset display shows the current volume level for the earpiece.

Adjusting the Speaker Volume

Handset Speaker: You can choose from six volume levels for the handset speaker while on a speakerphone call or when the handset is accessing the answering system. To adjust the handset speaker volume, press [**▲**] (to make it louder) or [**▼**] (to make it softer). The handset display shows the current volume level for the handset speaker.

Note: The handset earpiece and the handset speaker have separate volume settings.

Base Speaker: You can choose from ten volume levels for the base speaker while on a speakerphone call or when the answering system announces or plays a message. To adjust the base speaker volume, press [**▲**] (to make it louder) or [**▼**] (to make it softer). The base display shows the current volume level for the base speaker.

Adjusting the Audio Tone (Handset only)

If you aren't satisfied with the audio quality of your phone, you can adjust the Audio Tone of the earpiece while on a call. Your phone gives you three audio tone options: low, natural and high; the default setting, Natural Tone, is recommended for hearing aid users. Audio tone adjustments only apply to the earpiece, not the speakerphone.

To adjust the audio tone:

- 1) While on a call, press [**Menu/Select**].
- 2) Move the cursor to select AUDIO TONE, and then press [**Menu/Select**].
- 3) Move the cursor to select desired option (HIGH TONE, NATURAL TONE, or LOW TONE), and then press [**Menu/Select**]. Selected option appears in the display for two seconds, and then the display returns to normal.

Finding a Lost Handset

To locate a misplaced handset, press **[Int'com]** on the base when the phone is in standby. Use **[▲]** or **[▼]** to select the handset you want to page, and then press **[Menu/Select]**. Select ALL to page all registered handsets. To cancel paging, press **[Int'com]** on the base again.

Using Hold, Conference and Transfer

Placing a Call on Hold

- 1) During a call, press **[Clear/Int'com]** on the handset or **[Int'com]** on the base to place the caller on hold. If you leave a caller on hold for more than ten seconds, the display screen will read, Line On Hold.
- 2) To return to the party on hold, press **[Flash]** or **[⏪]** on the handset or **[⏪]** on the base. The phone will return to the holding party.

Notes:

- You can only place a caller on hold for five minutes. Once five minutes has passed, that party's line will be disconnected and the phone will return to standby.
- While a call is on hold, Caller ID and Call Waiting cannot be received.

Conferencing

If you have more than one handset, up to four people can participate in a conference call. A four-way conference call consists of an outside line, two handsets, and the base speakerphone. You can easily join a call already in progress.

- 1) Press **[Flash]** or **[⏪]** on the handset or **[⏪]** on the base to join the call.
- 2) To hang up, return the handset to the cradle or press **[1]** on the handset or **[⏪]** on the base. The other party will still be connected to the call.

Transferring a Call

You can transfer a call from one station to another.

- 1) During a call, press **[Clear/Int'com]** on the handset or **[Int'com]** on the base.
- 2) Use **[▲]** or **[▼]** to select the station you want to transfer the call to, and then press **[Menu/Select]**. Select ALL to page all other stations. The call will automatically be placed on hold, and a paging tone sounds. To cancel the transfer, press **[/Flash]** or **[⏏]** on the handset or **[⏏]** on the base.
- 3) When another station accepts the transferred call, you will be disconnected. If you want to rejoin the call, press **[/Flash]** or **[⏏]** on the handset or **[⏏]** on the base again.

Answering a Transferred Call

When a station receives a call transfer, it sounds a paging tone; stations also show the ID of the station that is paging. To accept the call transfer:

- 1) To answer the page and speak to the transferring station, press **[/Flash]** or **[Clear/Int'com]** on the handset, or **[⏏]** or **[Int'com]** on the base.
- 2) To accept the call and speak to the caller, press **[/Flash]** on the receiving handset, or **[⏏]** on the receiving base.
- 3) When you accept the transferred call, the transferring station will be disconnected.

Only the first station to answer the transfer page will be connected to the call. If the transfer page is not picked up within one minute, the operation will be canceled.

Using Special Features

Privacy Mode

If you don't want other stations to interrupt you while on a call, turn on privacy mode. As long as your station is in privacy mode, other stations can't join your call or make any calls of their own: their displays will show UNAVAILABLE.

- 1) While on a call, press **[Menu/Select]**.
- 2) Select CALL PRIVACY. PRIVACY MODE ON appears in the display for two seconds; **F** appears and remains in the display until the feature is turned off.

To turn privacy mode off, repeat the procedure listed above. PRIVACY MODE OFF appears.

Using the Intercom

You can use the intercom to talk to another station without using the phone line.

Making an Intercom Page

- 1) When the phone is in standby, press **[Clear/Int'com]** on the handset or **[Int'com]** on the base.
- 2) Use **[▲]** or **[▼]** to select the station you want to talk with, and then press **[Menu/Select]**. Select ALL to page all other stations.
- 3) To cancel the intercom page, press **[r]** on the handset or **[Int'com]** on the base.

Note: Intercom paging will be cancelled if any of the following things occur:

- You receive an outside call or an intercom page while selecting the other station.
- You do not select a station within thirty seconds.
- Your handset is out of range (OUT OF RANGE appears in the display).
- The party does not answer the page within one minute.
- The party is busy.
- The party is out of range (UNAVAILABLE appears in the display).



Answering an Intercom Page

When the intercom page tone sounds, the display will show the ID of the station that is paging.

- 1) Press **[*/Flash]** or **[Clear/Int'com]** on the handset, or **[Mute]** or **[Int'com]** on the base. If AutoTalk is on, the handset will automatically answer the page when you pick up the handset from the cradle.
- 2) To hang up an intercom call, press **[*]** on the handset or **[Int'com]** on the base.

Muting the Microphone

Mute turns off the microphone so the caller can't hear you. This only works while you are on a call.

- 1) Press **[Mute]** on the handset or **[Clear/Mute]** on the base. MUTE ON and  appear in the display;  remains while muting is on.
- 2) To cancel muting, press **[Mute]** on the handset or **[Clear/Mute]** on the base again. MUTE OFF appears.

Tone Dialing Switch Over

If your phone is set to pulse dialing, you can temporarily switch to tone dialing after the call connects. This feature is useful when you need tone dialing to use automated menu systems, such as telephone bank tellers, telephone prescription refills, customer support menus, etc. Make your call normally. Once your call connects, press **[*/tone]** on the station. Any digits you enter from then on will be sent with tone dialing. When this particular call ends, the phone automatically returns to pulse dialing.

See Changing the Dial Mode on page 11 for instructions on setting your phone for pulse or tone dialing.

Installing the Optional Headset

Your phone may be used with an optional headset. To use this feature, insert the headset plug into the headset jack. Your phone is ready for hands-free conversations. (Headsets may be purchased by calling the Uniden Parts Department. See the back cover page for contact information.)

Note: The waterproof handset cannot be used with a headset.

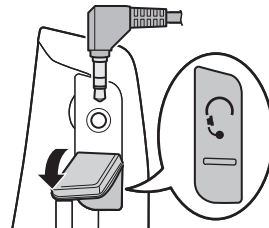

Setting Up the Answering System

Using Handset and Base Menus

You can set up your answering system's primary features from the base or handset.

- 1) When the phone is in standby, press **[Menu/Select]**. Move the pointer to select the ANSW. SETUP menu, and then press **[Menu/Select]**.
- 2) Use **[▲]** or **[▼]** to scroll through the answering system setup menu options.
- 3) Select the option by pressing **[Menu/Select]**.
- 4) To exit the menu and return to standby, press **[j]** on the handset or **[▷/□]** on the base.

Handset Operation

Your handset controls all of the answering system setup options except for the personal greeting (personal greetings must be changed directly at the base). Here are some hints on using your handset to access your answering system:

- When the phone is in standby, press **[☑/Mute]** on the handset to access the answering system. REMOTE ANSWERING MACHINE OPERATION appears on the handset display, and the system announces the time and the number of new and old messages.
- If you receive a call, remote operation is cancelled.
- If another handset makes a call, remote operation is cancelled.
- During remote operation HANDSET REMOTE MODE appears on the base.

Recording a Personal Greeting

Your answering system comes with a pre-recorded outgoing message or greeting that plays when you receive a call: "Hello, no one is available to take your call. Please leave a message after the tone." You can record your own personal outgoing greeting. Your recorded greeting must be between two seconds and thirty seconds long.

- 1) On the base, press **[Menu/Select]**. Select the ANSW. SETUP menu, and then the RECORD GREETING submenu.
- 2) RECORD GREETING, START [SELECT] appears. Press **[Menu/Select]** to start the recording. Begin recording after the announcement.
The **message counter** on the base LCD displays "30", and then begins to count down.
- 3) When you finish recording, press **[Menu/Select]** again or press **[▷/□]**. You will hear a confirmation tone, and your recorded greeting plays back for you.

Selecting a Greeting

Once you have recorded a personal greeting, the phone automatically switches to your personal greeting. You can also switch back and forth between the pre-recorded greeting and your own greeting at any time.

- 1) On the base, press **[Menu/Select]**. Select the ANSW. SETUP menu, and then the GREETING OPTIONS submenu.
The system plays the current greeting.
- 2) To keep this greeting, do nothing.
- 3) To switch to the other greeting, press **[◀◀]** or **[▶▶]** on the four-way function key while the system is playing the current greeting.
- 4) Each time you press **[◀◀]** or **[▶▶]**, the system switches between the pre-recorded and the personal greeting.
The last greeting you hear is used as the current greeting.

Deleting Your Personal Greeting

You can delete your personal greeting from the base. You cannot delete the pre-recorded greeting.

- 1) On the base, press **[Menu/Select]**. Select the ANSW. SETUP menu, and then the GREETING OPTIONS submenu.
The system plays the current greeting.
- 2) While the personal greeting is playing, press **[Ø]**.
- 3) The system announces "Greeting has been deleted," and switches back to the pre-recorded greeting.

Selecting the Language for Announcements

You can select the language of your answering system announcements. The default system language is English.

- 1) Press **[Menu/Select]**. Select ANSW. SETUP, and then the ANSW. LANGUAGE submenu.
- 2) Move the cursor to choose a language.
for US models: Choose ENGLISH or ESPAÑOL (Spanish).
for Canadian models: Choose ENGLISH or FRANÇAIS (French).
- 3) Press **[Menu/Select]**. You will hear a confirmation tone.

Setting the Number of Rings

The ring time setting allows you to set the number of rings the caller hears before your answering system plays the outgoing message. You can set the ring time to answer after two, four, or six rings. If you enable the Toll Saver (TS) setting, the answering system picks up after two rings if you have new messages, and after four rings if there are none. This way, if you make a long distance call to check your messages, you can hang up after the third ring to avoid long distance billing charges.

- 1) Press **[Menu/Select]**. Select the ANSW. SETUP menu, and then the RING TIME submenu.
- 2) Move the cursor to select a ring time (TOLL SAVER, 2 TIMES, 4 TIMES, or 6 TIMES).
- 3) Press **[Menu/Select]**. You will hear a confirmation tone.

Setting the Day & Time (for Base)

If you do not set the clock on your answering system, your messages may not have the correct time and day stamp.

- 1) Press **[Menu/Select]**.
- 2) Move the cursor to DAY & TIME and press **[Menu/Select]**.
- 3) Use **[▲]** and **[▼]** to select the day of the week, and press **[Menu/Select]**.
- 4) Use the number keypad (**[0]** through **[9]**) to enter the hour and minutes.
- 5) Use **[▲]** and **[▼]** to select AM or PM, and press **[Menu/Select]**. You hear a confirmation tone.

Notes:

- The handset does not display the day and time, although you can set up the day and time from the handset.

- When the power of the base is off, the day and time setting will be erased; you need to set up again.

Setting the Record Time (or Announce only)

You can choose how long callers have to record a message. Set the record time to 1 MINUTE or 4 MINUTES to limit the time for incoming messages. If you set the record time to ANNOUNCE ONLY, the answering system answers the call but prevents callers from leaving a message.

- 1) Press **[Menu/Select]**. Select the ANSW. SETUP menu, and then the RECORD TIME submenu.
- 2) Move the cursor to select a record time (1 MINUTE, 4 MINUTES, or ANNOUNCE ONLY).
- 3) Press **[Menu/Select]**. You will hear a confirmation tone.

While your answering system is set to ANNOUNCE ONLY, the **message counter** on the base LCD displays "A." If you are using the prerecorded greeting, the system automatically switches to the following message: "Hello, no one is available to take your call. Please call again." If you are using a personal greeting, the system continues to use that greeting.

Activating the Message Alert

The message alert feature sounds a short alert tone every fifteen seconds whenever you have a new message. To turn on the message alert:

- 1) Press **[Menu/Select]**. Select the ANSW. SETUP menu, and then the MESSAGE ALERT submenu.
- 2) Move the cursor to select ON or OFF.
- 3) Press **[Menu/Select]**. You will hear a confirmation tone.

Activating Call Screening on the Base

Your phone allows you to listen to callers leaving you a message. The call screen feature on the base can be turned on or off.

- 1) Press **[Menu/Select]**. Select the ANSW. SETUP menu and then the CALL SCREEN submenu.
- 2) Move the cursor to select ON or OFF.
- 3) Press **[Menu/Select]**. You will hear a confirmation tone.

Using the Answering System

Turning Your Answering System On and Off

| | From the base | From the handset |
|-------------|---|--|
| Turning On | <ol style="list-style-type: none">1) When the phone is in standby, press [Answer on/off].2) The system announces "Answering System is on" and plays the current greeting.3) ANSWER ON appears on the base display. | <ol style="list-style-type: none">1) Press [Menu/Select]. Select the ANSW. SETUP menu, and then the ANSWER SETUP submenu.2) Move the cursor to select ON.3) Press [Menu/Select]. You will hear a confirmation tone. |
| Turning Off | <ol style="list-style-type: none">1) When the phone is in standby, press [Answer on/off].2) The phone announces "Answering System is off."3) ANSWER OFF appears on the base display. | <ol style="list-style-type: none">1) Press [Menu/Select]. Select the ANSW. SETUP menu, and then the ANSWER SETUP submenu.2) Move the cursor to select OFF.3) Press [Menu/Select]. You will hear a confirmation tone. |

Reviewing Messages

The **message counter** on the base LCD displays the number of messages stored in memory. When you have new messages (that you have not listened to yet), **[▷/◁]** on the base and the **new message** LED on the handset flash. The answering system plays your new messages first. If you have no new messages, the system plays your old messages. You can review your messages from the base or from the handset:

| | From the base | From the handset |
|---------------------------|--|---|
| Playing new messages | Press [▷/◁] . The system announces the number of new and old messages, then plays the first new message followed by the day and time it was received. Then the system plays the new messages in the order they were received. | Press [✉/Mute] . The system announces the number of new and old messages, then plays the first new message followed by the day and time it was received. Then the system plays the new messages in the order they were received. |
| Repeating a message | Press [◀◀] once to go to the beginning of the current message. Press [◀◀] repeatedly to go back to a previous message. | Press [1] once to go to the beginning of the current message. Press [1] repeatedly to go back to a previous message. |
| Skipping a message | Press [▶▶] to go to the beginning of the next message. | Press [3] to go to the beginning of the next message. |
| Deleting a message | While a message is playing, press [0] . The message is permanently deleted. | While a message is playing, press [4] . The message is permanently deleted. |
| Deleting all messages | While the phone is in standby, press [0] . When the system asks you to confirm, press [0] again. All messages are permanently deleted. | Not available. |
| Playing old messages | After you listen to your new messages, press [▷/◁] again to play your old messages. | After you listen to your new messages, press [✉/Mute] again to play your old messages. |
| Ending the message review | Press [▷/◁] to stop the message playback and return to standby. | Press [5] to stop the message playback. Press [1] to exit the system and return to standby, or press [2] to restart the message playback. |

Screening Calls

If you activate the call screening feature on the base, you can listen to callers leaving a message without answering the call (see Activating Call Screening on the Base on page 45). You can always hear callers from the base speaker. To screen an incoming call from the handset speaker:

- Press **[M/Mute]** when the system is answering. If another handset is screening a call, you will hear a beep and you will not be able to screen the call.
- To answer the call, press **[F/Flash]**.
- To stop screening the call, press **[I]**.

Turning Off the Message Alert Tone

When all new messages are played back, the message alert tone will automatically deactivate. The tone will not deactivate until all new messages are played back. To quickly turn off the tone, press any key on the base.

Operating the Answering System While You Are Away from Home

When you are away from home, you can operate your answering system with any touch-tone telephone.

Setting a Security Code or Personal Identification Number (PIN)

To operate your answering system when you are away from home, you will need to enter a two-digit security code or Personal Identification Number (PIN). The default security code is 80.

- 1) Press **[Menu/Select]**. Select the ANSW. SETUP menu, and then the SECURITY CODE submenu.
- 2) Use the number keypad (**[0]** through **[9]**) to enter a two-digit security code (01-99).
- 3) Press **[Menu/Select]**. You will hear a confirmation tone.

Dialing in to Your Answering System

Notes:

- The answering system will only playback messages for four minutes and then it returns to the command waiting mode. To continue playing your messages, press **[0]** then **[2]** again within fifteen seconds.
- If you enter an incorrect security code/PIN three times, you will hear a beep and the answering system will return to standby.

To operate from a remote location, use any touch-tone telephone, and follow these steps:

- 1) Call your telephone number and wait for the system to answer. If the answering system is off, it will answer after about ten rings and sounds a series of beeps.
- 2) During the greeting or the beeps (if answering system is off), press **[0]** and enter your security code/PIN within two seconds.
- 3) The answering system announces the current time and the number of messages stored in memory. You hear "To play incoming messages, press zero-two. For help, press one-zero" followed by a beep.
- 4) Enter a remote command from the chart below. You have fifteen seconds to enter the first command; after the first command, you have two seconds to enter each command.

Remote Commands

| Command | Function | Command | Function | Command | Function |
|----------------------------|------------------------|----------------------------|---------------------|----------------------------|----------------------|
| [0] then [1] | Repeat a message* | [0] then [4] | Delete a message | [0] then [9] | Answering system off |
| [0] then [2] | Play incoming messages | [0] then [5] | Stop operation | [1] then [0] | Help |
| [0] then [3] | Skip a message | [0] then [6] | Answering system on | | |

* If you press **[0]** then **[1]** in the first four seconds of a message, the system skips to the previous message.
If you press **[0]** then **[1]** after the first four seconds of a message, the system repeats the current message.

- 5) When you finish, you will hear intermittent beeps indicating that the system is in the command waiting mode. Enter another command from the chart within fifteen seconds.
- 6) Hang up to exit the system. The answering system automatically returns to its normal standby setting.

Maintenance

Specifications

| | | | |
|-------------------------------|---------------------------------|-----------------|-----------------------|
| Operating Temperature | 32° F to 122° F (0° C to 50° C) | | |
| AC Adapter information | Base | Chargers | Yellow charger |
| Part Number | PS-0009 | PS-0007 | PS-0011 |
| Input Voltage | 120V AC, 60 Hz | 120V AC, 60 Hz | 120V AC, 60 Hz |
| Output Voltage | 9V DC @ 350mA | 9V DC @ 210mA | 19V DC @ 100mA |
| Battery Part Number | BT-1008 | | |
| Battery Capacity | 2.4V DC @ 650mAh | | |

Notes:

- Use only the supplied AC adapters.
- Be sure to use the proper adapter for the base and any chargers.
- Do not place the power cord where it creates a trip hazard or where it could become chafed and create a fire or electrical hazard.
- Do not place the base in direct sunlight or subject it to high temperatures.

Battery Information

Battery Life

With average use, your handset battery provides approximately ten hours of talk time and approximately seven days of standby time. You can achieve optimum battery life and performance by returning the handset to the base or charger after each use. When your handset is left off of the cradle, the battery will gradually discharge even if the handset is not being used. The actual talk time duration will be reduced in proportion to the amount of time the handset is off of the cradle.

Low Battery Alert

When the battery pack is very low, the phone is programmed to eliminate functions in order to save power. When LOW BATTERY appears in the handset display and the phone is in standby, none of the keys will operate. If you are on a call, complete your conversation as quickly as possible, and return the handset to the cradle.

The battery pack needs to be charged when the empty battery icon appears.

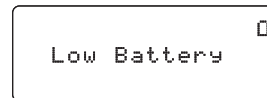

Cleaning the Battery Contacts

To maintain a good charge, clean the charging contacts on the handset once a month. Dampen a cloth with plain water. Gently rub the damp cloth over the charging contacts until all visible dirt is removed. Dry the contacts thoroughly before returning the handset to the cradle.

Caution: Do not use paint thinner, alcohol, or other chemical products. Doing so may discolor the surface of the telephone and damage the finish.

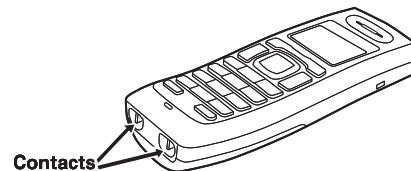

Battery Replacement and Handling

With average use, your phone's battery should last approximately one year. To order replacement batteries, please contact Uniden's Parts Department. The contact information is listed on the back cover page.

Caution:

- Use only battery pack BT-1008.
- Do not remove the batteries from the handset to charge them.
- Never throw the battery into a fire, disassemble, or heat them.
- Do not remove or damage the battery casing.

Replacing the Waterproof Handset Battery Pack

- 1) Remove the four screws holding the battery compartment with a screwdriver and take off the battery cover.
- 2) Remove the old battery pack from the battery compartment.
- 3) Line up the red and black wires with the polarity label in the battery compartment (the connector only fits one way). Push the connector in firmly; you should hear the connector click into place.
- 4) Tug on the battery wires slightly to make sure you have a good connection.
- 5) Before placing the battery cover back on the handset, check the rubber seal located on the under side of the cover: make sure that the seal is in good condition and that there is no foreign matter under the seal.

Note: If the rubber seal appears worn, nicked, or dried out, replacement seals are available through the Uniden Parts Department. See the back cover page for contact information.

- 6) Insert the bottom end of the cover into the grooves on the handset and lay the cover over the battery compartment. Tighten the four screws securely.

- Notes:
- If there is any foreign matter on the rubber seal located on the under side of the battery cover, the handset may not be water tight.
 - The rubber seal should be replaced every two years, even if it does not look worn.

Power Failures

During a power failure, you will not be able to make or receive calls with the phone. To avoid damage from an electrical spike when the power comes back on, we recommend you unplug your phone during power outages.

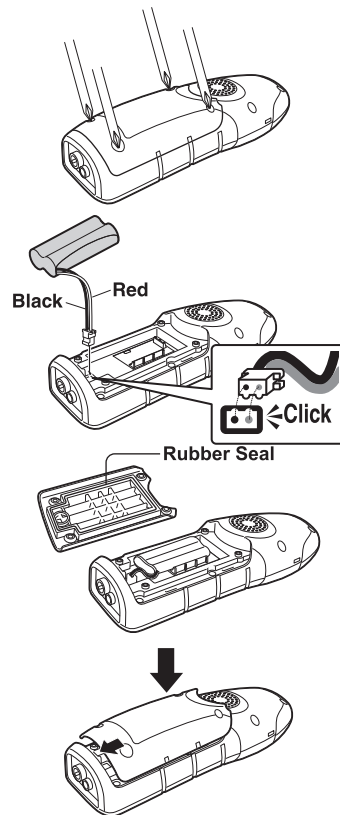

Troubleshooting

Common Issues

If your phone is not performing to your expectations, please try these simple steps first. If these steps do not solve your problem, please call our Customer Hotline (see the inside of the back cover for contact information).

| When you have this problem... | Try... |
|--|--|
| The charge LED won't illuminate when the handset is placed in the cradle. | <ul style="list-style-type: none">• Checking the AC adapter connection (see page 8).• Re-seating the handset in the cradle.• Cleaning the charging contacts on the handsets (see page 51). |
| The audio sounds weak. | <ul style="list-style-type: none">• Moving the handset closer to the base.• Moving the handset and/or base away from metal objects or appliances and try again. |
| No handsets can make or receive calls. | <ul style="list-style-type: none">• Checking the telephone cord connection. If CHECK TEL LINE appears on the base display, the telephone cord may not be connected correctly (see page 10).• Disconnecting the base AC adapter. Wait a few minutes, then reconnect it (see page 7).• Asking your telephone company if they use pulse dialing (see page 11). |
| A single handset can't make or receive calls (but other handsets can). | <ul style="list-style-type: none">• Checking the battery pack connection (see page 7).• Charging the battery for 15 to 20 hours.• Moving the handset closer to the base.• Making sure the line is not in use. If an outside call is already using a line, you cannot use that line to make another outside call.• Resetting the handset (see page 55). |

| When you have this problem... | Try... |
|--|---|
| A handset can make calls, but it doesn't ring or receive a page. | <ul style="list-style-type: none"> • Making sure the ringer isn't turned off (see page 35). |
| Severe noise interference. | <ul style="list-style-type: none"> • Keeping all handsets away from microwave ovens, computers, wireless LAN station, remote control toys, wireless microphones, alarm systems, intercoms, room monitors, fluorescent lights, and electrical appliances (see page 6). • Moving the base to another location or turn off the source of interference. |
| The Caller ID does not display. | <ul style="list-style-type: none"> • Checking to see if the call was placed through a switchboard. • Asking your telephone company to verify your Caller ID service is current. There may be a problem with your Caller ID service. |
| I can't register the handset at the base. | <ul style="list-style-type: none"> • Charging the battery for 15 to 20 hours. • Resetting the handset (see page 55). |
| The handset doesn't communicate with other handsets. | <ul style="list-style-type: none"> • Resetting the handset (see page 55). • Resetting all handsets (see page 55). |
| I can't join the conversation. | <ul style="list-style-type: none"> • Checking to see that there are not two handsets already using the conference feature (see page 37). • Checking to see that another handset is not in privacy mode (see page 39). • Resetting the handset (see page 55). • Resetting all handsets (see page 55). |
| The answering system does not work. | <ul style="list-style-type: none"> • Checking the AC adapter connection (see page 8). • Checking to see if the answering system is turned on (see page 46). • Checking to see that the message record time is not set to announce only (see page 44). |

| When you have this problem... | Try... |
|---|--|
| The answering system does not record any messages. | <ul style="list-style-type: none"> • The memory may be full. Delete some or all of the saved messages (see page 47). |
| The answering system doesn't say what time messages were recorded. | <ul style="list-style-type: none"> • Checking to see if you have set the time (see page 44). |
| Messages are incomplete. | <ul style="list-style-type: none"> • The incoming messages may be too long. Ask callers to leave a brief message. • The memory may be full. Delete some or all of the saved messages (see page 47). |
| I can't hear base or handset speaker during call screening or message playback. | <ul style="list-style-type: none"> • Adjusting the speaker volume on the base or handset (see page 35). • Checking to see if the call screen feature is set to on (see page 45). |
| I can't access answering system from a remote phone. | <ul style="list-style-type: none"> • Checking to see if you are using the correct PIN number (see page 48). • Checking to see if the touch-tone phone you're using can transmit the tone for at least two seconds. If it cannot, try using a different touch-tone phone. |

Resetting the Handset

You may need to reset your handset in the following instances:

- You get the message Registration Failed when you try to register the handset.
- You are unable to register any handsets to the base.
- When you are instructed to by one of Uniden's call center representatives.

- 1) Press and hold **[*]** and **[#]** for more than five seconds. Select DEREGISTER HS.
- 2) Select the handset which you are operating, and then press **[Menu/Select]**.

- 3) The phone will ask you to confirm the deregistration. Select YES. The selected handset will clear its registration information from the base and then delete the link to the base from its own memory.
- 4) When the base information is deleted, the handset displays HANDSET NOT REGISTERED-PLACE HANDSET ON BASE TO REGISTER. SEE YOUR OWNER'S MANUAL FOR HELP.

5) Reregister the handset:

For regular handsets:

- Place the handset in the base; HANDSET REGISTERING will appear in the LCD.
- Wait approximately thirty seconds, "REGISTRATION COMPLETE" appears in the display.
- If REGISTRATION FAILED appears in the LCD, please try these steps again.

For the waterproof handset:

- With the phone in standby, press **[Menu/Select]** on the base.
- Move the cursor to select the REGISTER HANDSET menu, and then press **[Menu/Select]**. HANDSET REGISTERING will appear.
- On the handset, press and hold **[#]** until the handset beeps and displays HANDSET REGISTERING.
- When the handset has registered to the base, the LCD will display REGISTRATION COMPLETE.
- If REGISTRATION FAILED appears in the LCD, please try these steps again.

- Notes:
- If the handset cannot contact the base, it will display OUT OF RANGE. Make sure the handset is in range of the base and the base is connected to power.
 - If your base is not available for some reason (for example, it was lost or damaged), the BASE UNAVAILABLE option will reset the handsets so you can use them with a replacement base. Contact Uniden Customer Service if you need to replace your base with a new one.

Changing the Line Mode for Multiple Extensions

Line mode refers to the method that telephones use to signal each other that an extension is in use. Customer service may recommend changing the line mode if you have any of the following problems:

- Your phone keeps ringing after someone answers on an extension phone.
 - Your answering system doesn't stop recording when you answer on an extension phone.
 - Caller ID displays briefly and then clears.
- 1) Press **[Menu/Select]**. Select the GLOBAL SETUP menu, and then the SET LINE MODE submenu.
 - 2) IF INSTRUCTED BY CUSTOMER SERVICE PRESS [SELECT] appears. Press **[Menu/Select]**.
 - 3) Move the cursor to select TYPE - A, TYPE - B, or OFF.
 - 4) Press **[Menu/Select]**. You will hear a confirmation tone.

Traveling Out of Range

During a call, if you move your handset too far from your base, noise may increase. If you pass the range limit of the base, the handset will beep, display OUT OF RANGE, and then go to standby. The base will maintain the connection for thirty seconds after the handset goes out of range. If you move the handset back within range of the base within thirty seconds, press **[Flash]** or **[Mute]** to pick up the call again.

Liquid Damage

Moisture and liquid can damage your cordless phone.

- If the handset or base is exposed to moisture or liquid, but only the exterior plastic housing is affected, wipe off the liquid, and use as normal.
- If moisture or liquid has entered the plastic housing (i.e. liquid can be heard in the phone or liquid has entered the handset battery compartment or vent openings on the base), follow the steps below:

| Handset | Base |
|---|---|
| <ol style="list-style-type: none">1) Remove the battery cover and leave it off for ventilation.2) Disconnect the battery pack. Leave the battery cover off and the battery pack disconnected for at least 3 days.3) Once the handset is completely dry, reconnect the battery pack and the battery cover.4) Recharge the handset's battery pack for 15 to 20 hours before using. | <ol style="list-style-type: none">1) Disconnect the AC adapter from the base, cutting off electrical power.2) Disconnect the telephone cord from the base.3) Let dry for at least 3 days. |

IMPORTANT: You must unplug the telephone line while recharging the battery packs to avoid charge interruption.

CAUTION: **DO NOT use a microwave oven to speed up the drying process. This will cause permanent damage to the handset, base and the microwave oven. After following these steps, if your phone does not work, please call our Customer Service Hotline (see the back cover page).**

If the waterproof handset falls in water

If your waterproof handset is submerged in water, just pull it out and dry it off. You might notice that the sound is distorted. This is because there is still water remaining in and around the speaker and microphone. Just shake the handset to clear excess water, and the sound should return to normal.

Note: The charging cradle is not waterproof. If the charging cradle falls into water, unplug it before attempting to remove it from the water. Allow the cradle to dry completely before reconnecting the power.

Precautions!

Before you read anything else, please observe the following:

Warning!

Other than the waterproof handset, Uniden America Corporation DOES NOT represent any other part of this unit to be waterproof. To reduce the risk of fire, electrical shock, or damage to the unit, DO NOT expose this unit to rain or moisture.

Rechargeable Nickel-Metal-Hydride Battery Warning

- This equipment contains a rechargeable Nickel-Metal-Hydride battery.
- The rechargeable batteries contained in this equipment may explode if disposed of in a fire.
- Nickel is a chemical known to state of California to cause cancer.
- Do not short-circuit the battery.
- Do not charge the rechargeable battery used in this equipment in any charger other than the one designed to charge this battery as specified in the owner's manual. Using another charger may damage the battery or cause the battery to explode.

Rechargeable Batteries Must Be Recycled or Disposed of Properly.

Uniden works to reduce lead content in our PVC coated cords in our products and accessories.

Warning!

The cords on this product and/or accessories contain lead, a chemical known to the State of California to cause birth defects or other reproductive harm. Wash hands after handling.

Important Safety Instructions

When using your telephone equipment, basic safety precautions should always be followed to reduce the risk of fire, electric shock and injury to persons, including the following:

1. Do not use this product near water, for example, near a bath tub, wash bowl, kitchen sink or laundry tub, in a wet basement or near a swimming pool.
2. Avoid using a telephone (other than a cordless type) during an electrical storm. There may be a remote risk of electric shock from lightning.
3. Do not use the telephone to report a gas leak in the vicinity of the leak.
4. Use only the power cord and batteries indicated in this manual. Do not dispose of batteries in a fire. They may explode. Check with local authorities for possible battery disposal instructions.
5. Do not disassemble any component of this product.

SAVE THESE INSTRUCTIONS

CAUTION

Risk of explosion if battery is replaced by an incorrect type. Dispose of used batteries according to the instructions. Do not open or mutilate the battery, and disconnect the battery before shipping this product.

The FCC Wants You To Know

This equipment complies with Part 68 of the FCC rules and the requirements adopted by the ACTA. On the bottom of this equipment is a label that contains, among other information, a product identifier in the format US: AAAEQ##TXXXX. If requested, this number must be provided to the telephone company.

An applicable Universal Service Order Codes (USOC) certification for the jacks used in this equipment is provided (i.e., RJ11C) in the packaging with each piece of approved terminal equipment. A plug and jack used to connect this equipment to the premises wiring and telephone network must comply with the applicable FCC Part 68 rules and requirements adopted by the ACTA. A compliant telephone cord and modular plug is provided with this product. It is designed to be connected to a compatible modular jack that is also compliant. See installation instructions for details.

The REN is used to determine the number of devices that may be connected to a telephone line. Excessive RENs on a telephone line may result in the devices not ringing in response to an incoming call. In most but not all areas, the sum of RENs should not exceed five (5.0). To be certain of the number of devices that may be connected to a line, as determined by the total RENs, contact the telephone provider. For products approved after July 23, 2001, the REN for this product is part of the product identifier that has the format US:AAAEQ##TXXXX. The digits represented by ## are the REN without a decimal point (e.g., .03 is a REN of 0.3). For earlier products, the REN is separately shown on the label.

If this equipment causes harm to the telephone network, the telephone company will notify you in advance that temporary discontinuance of service may be required. But if advance notice isn't practical, the telephone company will notify the customer as soon as possible. Also, you will be advised of your right to file a complaint with the FCC if you believe it is necessary. The telephone company may make changes in its facilities, equipment, operations or procedures that could affect the operation of the equipment. If this happens the telephone company will provide advance notice in order for you to make necessary modifications to maintain uninterrupted service.

Please follow instructions for repairing, if any (e.g. battery replacement section); otherwise do not substitute or repair any parts of the device except as specified in this manual. Connection to party line service is subject to state tariffs. Contact the state public utility commission, public service commission or corporation commission for information. This equipment is hearing aid compatible.

Should you experience trouble with this equipment, please contact Uniden customer service at 800-297-1023. If the equipment is causing harm to the telephone network, the telephone company may request that you disconnect the equipment until the problem is resolved.

NOTICE: According to telephone company reports, AC electrical surges, typically resulting from lightning strikes, are very destructive to telephone equipment connected to AC power sources. To minimize damage from these types of surges, a surge arrester is recommended.

Changes or modifications to this product not expressly approved by Uniden, or operation of this product in any way other than as detailed by the owner's manual, could void your authority to operate this product.

This device complies with part 15 of the FCC rules. Operation is subject to the following two conditions: (1) This device may not cause harmful interference, and (2) This device must accept any interference received, including interference that may cause undesired operation. Privacy of communications may not be ensured when using this phone.

To insure the safety of users, the FCC has established criteria for the amount of radio frequency energy various products may produce depending on their intended usage. This product has been tested and found to comply with the FCC's exposure criteria. For body worn operation, the FCC RF exposure guidelines were also met when used with the Uniden accessories supplied or designed for this product. Use of other accessories may not ensure compliance with FCC RF exposure guidelines and should be avoided.

The antenna(s) used for the base-unit must be installed to provide a separation distance of at least 20 cm from all persons and must not be collocated or operated in conjunction with any other antenna or transmitter.

If your home has wired alarm equipment connected to a phone line, be sure that installing the system does not disable your alarm equipment.

If you have questions about what will disable alarm equipment, contact your telephone company or a qualified installer.

Radio Interference

Radio interference may occasionally cause buzzing and humming in your cordless handset, or clicking noises in the base. This interference is caused by external sources such as TV, refrigerator, vacuum cleaner, fluorescent lighting, or electrical storm. Your unit is NOT DEFECTIVE. If these noises continue and are too distracting, please check around your home to see what appliances may be causing the problem. In addition, we recommend that the base not be plugged into a circuit that also powers a major appliance because of the potential for interference. Be certain that the antenna on the unit is fully extended when needed. In the unlikely event that you consistently hear other voices or distracting transmissions on your phone, you may be receiving radio signals from another cordless telephone or other source of interference. If you cannot eliminate this type of interference, you need to change to a different channel.

Finally, it should be noted that some cordless telephones operate at frequencies that may cause interference to nearby TVs and VCRs. To minimize or prevent such interference, the base of the cordless telephone should not be placed near or on top of a TV or VCR. If interference is experienced, moving the cordless telephone farther away from the TV or VCR will often reduce or eliminate the interference.

Cordless Telephone Privacy

Cordless telephones are radio devices. Communications between the handset and base of your cordless telephone are accomplished by means of radio waves which are broadcast over the open airways. Because of the inherent physical properties of radio waves, your communications can be received by radio receiving devices other than your own cordless telephone unit. Consequently, any communications using your cordless telephone may not be private.

I.C. Notice

Terminal Equipment

NOTICE: This equipment meets the applicable Industry Canada Terminal Equipment Technical Specifications. This is confirmed by the registration number. The abbreviation, IC, before the registration number signifies that registration was performed based on a Declaration of Conformity indicating that Industry Canada technical specifications were met. It does not imply that Industry Canada approved the equipment.

NOTICE: The Ringer Equivalence Number (REN) for this terminal equipment is marked on the equipment itself. The REN assigned to each terminal equipment provides an indication of the maximum number of terminals allowed to be connected to a telephone interface. The termination on an interface may consist of any combination of devices subject only to the requirement that the sum of the Ringer Equivalence Numbers of all the devices does not exceed five.

Radio Equipment

The term "IC:" before the radio certification number only signifies that Industry Canada technical specifications were met.

Operation is subject to the following two conditions: (1) this device may not cause interference, and (2) this device must accept any interference, including interference that may cause undesired operation of the device. "Privacy of communications may not be ensured when using this telephone."

One Year Limited Warranty

Important: Evidence of original purchase is required for warranty service. **WARRANTOR: UNIDEN AMERICA CORPORATION ("Uniden") ELEMENTS OF WARRANTY:** Uniden warrants, for one year, to the original retail owner, this Uniden Product to be free from defects in materials and craftsmanship with only the limitations or exclusions set out below. **WARRANTY DURATION:** This warranty to the original user shall terminate and be of no further effect 12 months after the date of original retail sale. The warranty is invalid if the Product is (A) damaged or not maintained as reasonable or necessary, (B) modified, altered, or used as part of any conversion kits, subassemblies, or any configurations not sold by Uniden, (C) improperly installed, (D) serviced or repaired by someone other than an authorized Uniden service center for a defect or malfunction covered by this warranty, (E)

used in any conjunction with equipment or parts or as part of any system not manufactured by Uniden, or (F) installed or programmed by anyone other than as detailed by the owner's manual for this product. **STATEMENT OF REMEDY:** In the event that the product does not conform to this warranty at any time while this warranty is in effect, warrantor will either, at its option, repair or replace the defective unit and return it to you without charge for parts, service, or any other cost (except shipping and handling) incurred by warrantor or its representatives in connection with the performance of this warranty. Warrantor, at its option, may replace the unit with a new or refurbished unit. **THE LIMITED WARRANTY SET FORTH ABOVE IS THE SOLE AND ENTIRE WARRANTY PERTAINING TO THE PRODUCT AND IS IN LIEU OF AND EXCLUDES ALL OTHER WARRANTIES OF ANY NATURE WHATSOEVER, WHETHER EXPRESS, IMPLIED OR ARISING BY OPERATION OF LAW, INCLUDING, BUT NOT LIMITED TO ANY IMPLIED WARRANTIES OF MERCHANTABILITY OR FITNESS FOR**

A PARTICULAR PURPOSE. THIS WARRANTY DOES NOT COVER OR PROVIDE FOR THE REIMBURSEMENT OR PAYMENT OF INCIDENTAL OR CONSEQUENTIAL DAMAGES.

Some states do not allow this exclusion or limitation of incidental or consequential damages so the above limitation or exclusion may not apply to you.

LEGAL REMEDIES: This warranty gives you specific legal rights, and you may also have other rights which vary from state to state. This warranty is void outside the United States of America and Canada. **PROCEDURE FOR OBTAINING PERFORMANCE OF WARRANTY:** If, after following the instructions in the owner's manual you are certain that the Product is defective, pack the Product carefully (preferably in its original packaging). Disconnect the battery from the Product and separately secure the battery in its own separate packaging within the shipping carton. The Product should include all parts and accessories originally packaged with the Product. Include evidence of original purchase and a note describing the defect that has caused you to return it. The Product should be shipped freight prepaid, by traceable means, to warrantor at:

Uniden America Service

4700 Amon Carter Blvd.
Fort Worth, TX 76155

Index

A

| | |
|---------------------------|----|
| Accessibility | 5 |
| Answering calls..... | 30 |
| Answering system | |
| Reviewing messages | 47 |
| Setting up | 41 |
| Turning on/off | 46 |
| When away from home | 48 |
| Any key answer | 29 |
| Area code | 33 |
| AutoTalk..... | 29 |

B

| | |
|--------------------------------|----|
| Banner | 28 |
| Base | |
| Installing..... | 8 |
| Parts of the base | 17 |
| Reading the display..... | 18 |
| Wall mounting | 12 |
| Battery | |
| Battery life | 50 |
| Installing..... | 7 |
| Low battery alert..... | 52 |
| Replacement and handling | 51 |
| Belt clip | 8 |

C

| | |
|----------------------------------|--------|
| Caller ID..... | 32 |
| Deleting Caller ID records | 33 |
| Making calls from | 32 |
| Call screening..... | 45, 48 |
| Call waiting | 34 |
| Chain dialing..... | 31 |
| Conferencing | 37 |

D

| | |
|--------------------|--------|
| Day and time | 44 |
| Dial mode | 11, 40 |

F

| | |
|------------------------|----|
| FCC statements..... | 60 |
| Finding a handset..... | 37 |

G

| | |
|-----------------|----|
| Greetings | |
| Deleting | 43 |
| Recording..... | 42 |
| Selecting | 42 |

H

| | |
|--|----|
| Handset | |
| Accessing the answering system..... | 41 |

| | |
|---------------------------------|----|
| Banner..... | 28 |
| Choosing a ringer..... | 28 |
| Copying phonebook entries | 26 |
| Entering text | 20 |
| Finding | 37 |
| Parts of the handset..... | 16 |
| Reading the display..... | 18 |
| Resetting..... | 55 |
| Hanging up | 30 |
| Headset | 40 |
| Hold | 37 |

I

| | |
|--------------------|----|
| Installation | 6 |
| Intercom..... | 39 |

K

| | |
|---------------------|----|
| Key touch tone..... | 22 |
|---------------------|----|

L

| | |
|--|----|
| Language | |
| Answering system announcements..... | 43 |
| Display | 21 |
| Line mode for base..... | 57 |
| Liquid damage | 58 |
| Low battery alert..... | 51 |

M

| | |
|---------------------------|--------|
| Maintenance | 50 |
| Making a calls..... | 30 |
| Using Caller ID..... | 32 |
| Using redial | 34 |
| Using the phonebook | 31 |
| Message alert..... | 45, 48 |
| Mute | |
| Microphone | 40 |
| Ringer..... | 35 |

O

| | |
|-------------------|----|
| Out of range..... | 57 |
|-------------------|----|

P

| | |
|---|----|
| Personal identification number (PIN) | 48 |
| Personal ring | 22 |
| Phonebook | 23 |
| Copying entries | 26 |
| Creating new entries | 23 |
| Deleting entries | 25 |
| Editing entries | 24 |
| Finding entries..... | 24 |
| Making a call from..... | 31 |
| Storing Caller ID or redial numbers | 25 |

| | |
|---------------------|--------|
| Privacy mode..... | 39 |
| Pulse dialing | 11, 40 |

R

| | |
|---------------------------------|----|
| Redial | |
| Deleting a record..... | 34 |
| Making a calls with..... | 34 |
| Ringer | |
| Choosing a handset ringer | 28 |
| Muting | 35 |
| Personal ring..... | 22 |

S

| | |
|---------------------------|--------|
| Safety notices | 59 |
| Screening calls | 45, 48 |
| Security code..... | 48 |
| Seven-digit dialing | 33 |

T

| | |
|--------------------------|--------|
| Text, entering..... | 20 |
| Tone dialing | 11, 40 |
| Transferring a call..... | 38 |

V

| | |
|-------------------------|----|
| Volume, adjusting | 35 |
|-------------------------|----|

W

| | |
|------------------------------|----|
| Wall mounting the base | 12 |
| Warranty | 62 |

Remote Operation Card

CUT

REMOTE OPERATION CARD

Uniden®

Remote access away from home

1. Call your phone number from a touch-tone phone.
2. During the outgoing message, press 0 and enter your PIN code. The answering system announces the number of messages stored in memory and the voice prompts.
3. To quit, hang up the phone.

Turn on the answering system remotely

1. Call your phone and let it ring 10 times until you hear a beep.
2. Press 0 and then enter your PIN code.
3. Press 0 then 5 to stop the announcement.
4. Press 0 then 6 to turn the answering system on.

CUT

REMOTE OPERATION CARD

Uniden®

Remote access away from home

1. Call your phone number from a touch-tone phone.
2. During the outgoing message, press 0 and enter your PIN code. The answering system announces the number of messages stored in memory and the voice prompts.
3. To quit, hang up the phone.

Turn on the answering system remotely

1. Call your phone and let it ring 10 times until you hear a beep.
2. Press 0 and then enter your PIN code.
3. Press 0 then 5 to stop the announcement.
4. Press 0 then 6 to turn the answering system on.

CUT

REMOTE OPERATION CARD

Uniden®

Remote access away from home

1. Call your phone number from a touch-tone phone.
2. During the outgoing message, press 0 and enter your PIN code. The answering system announces the number of messages stored in memory and the voice prompts.
3. To quit, hang up the phone.

Turn on the answering system remotely

1. Call your phone and let it ring 10 times until you hear a beep.
2. Press 0 and then enter your PIN code.
3. Press 0 then 5 to stop the announcement.
4. Press 0 then 6 to turn the answering system on.

CUT

REMOTE OPERATION CARD

Uniden®

















Remote access away from home

1. Call your phone number from a touch-tone phone.
2. During the outgoing message, press 0 and enter your PIN code. The answering system announces the number of messages stored in memory and the voice prompts.
3. To quit, hang up the phone.

















Turn on the answering system remotely

1. Call your phone and let it ring 10 times until you hear a beep.
2. Press 0 and then enter your PIN code.
3. Press 0 then 5 to stop the announcement.
4. Press 0 then 6 to turn the answering system on.

















CUT

| Task | Key |
|------------------------|---|
| Repeat a Message |   |
| Play Incoming Messages |   |
| Skip a Message |   |
| Delete a Message |   |
| Stop Operation |   |
| Answering System On |   |
| Answering System Off |   |
| Help |   |

















CUT

| Task | Key |
|------------------------|---|
| Repeat a Message |   |
| Play Incoming Messages |   |
| Skip a Message |   |
| Delete a Message |   |
| Stop Operation |   |
| Answering System On |   |
| Answering System Off |   |
| Help |   |

CUT

| Task | Key |
|------------------------|---|
| Repeat a Message |   |
| Play Incoming Messages |   |
| Skip a Message |   |
| Delete a Message |   |
| Stop Operation |   |
| Answering System On |   |
| Answering System Off |   |
| Help |   |

CUT

| Task | Key |
|------------------------|---|
| Repeat a Message |   |
| Play Incoming Messages |   |
| Skip a Message |   |
| Delete a Message |   |
| Stop Operation |   |
| Answering System On |   |
| Answering System Off |   |
| Help |   |

May be covered under one or more of the following U.S. patents:

| | | | | | | | |
|-----------|-----------|-----------|-----------|-----------|-----------|-----------|-----------|
| 4,797,916 | 5,426,690 | 5,434,905 | 5,491,745 | 5,493,605 | 5,533,010 | 5,574,727 | 5,581,598 |
| 5,650,790 | 5,660,269 | 5,661,780 | 5,663,981 | 5,671,248 | 5,696,471 | 5,717,312 | 5,732,355 |
| 5,754,407 | 5,758,289 | 5,768,345 | 5,787,356 | 5,794,152 | 5,801,466 | 5,825,161 | 5,864,619 |
| 5,893,034 | 5,912,968 | 5,915,227 | 5,929,598 | 5,930,720 | 5,960,358 | 5,987,330 | 6,044,281 |
| 6,070,082 | 6,125,277 | 6,253,088 | 6,314,278 | 6,418,209 | 6,618,015 | 6,671,315 | 6,714,630 |
| 6,782,098 | 6,788,920 | 6,788,953 | 6,839,550 | 6,889,184 | 6,901,271 | 6,907,094 | 6,914,940 |
| 6,953,118 | 7,023,176 | 7,030,819 | 7,146,160 | 7,203,307 | 7,206,403 | | |

Other patents pending.



VISIT OUR WEBSITE AT
WWW.UNIDEN.COM IF YOU...

- ...HAVE A QUESTION OR A PROBLEM.
Or call our Customer Hotline at 1-800-297-1023 during regular business hours.*
- ...ARE LOOKING FOR A PART OR ACCESSORY.
Or call our Parts Department at 1-800-554-3988 during regular business hours.*
- ...NEED SPECIAL ASSISTANCE DUE TO A DISABILITY.
Or call our Accessibility help line at 1-800-874-9314 (voice or TTY).

Free Manuals Download Website

<http://myh66.com>

<http://usermanuals.us>

<http://www.somanuals.com>

<http://www.4manuals.cc>

<http://www.manual-lib.com>

<http://www.404manual.com>

<http://www.luxmanual.com>

<http://aubethermostatmanual.com>

Golf course search by state

<http://golfingnear.com>

Email search by domain

<http://emailbydomain.com>

Auto manuals search

<http://auto.somanuals.com>

TV manuals search

<http://tv.somanuals.com>