

DX 834 Series



Uniden[®]
Operating Guide

UDZZ01525BZ

Download from www.Somanuals.com. All Manuals Search And Download.

Cordless Extend • A • Phone[®]

PRECAUTIONS

Before you read anything else,
please observe the following:

WARNING!

Uniden Australia Pty. Ltd/Uniden New Zealand Ltd **DOES NOT** represent this unit to be waterproof. To reduce the risk of fire, electrical shock or damage to the unit, **DO NOT** expose this unit to rain or moisture.

RECHARGEABLE NICKEL-CADMIUM BATTERY WARNING

- This equipment contains a Rechargeable Nickel-Cadmium Battery.
- The Rechargeable Nickel-Cadmium Battery contained in this equipment may explode if disposed of in a fire.
- Do not short-circuit the battery.
- Do not charge the Rechargeable Nickel-Cadmium Battery used in this equipment in any charger other than the one designed to charge this battery as specified in this Guide.
Using another charger may damage the battery or cause the battery to explode.

RECHARGEABLE NICKEL-CADMIUM BATTERIES MUST BE RECYCLED OR DISPOSED OF PROPERLY



The exclamation point within an equilateral triangle is intended to alert the user to the presence of important operating and maintenance (servicing) instructions in the literature accompanying the appliance.

CONTENTS

Precautions	.2
Contents	.3
Important Safety Instructions	.4
Battery Safety Precautions	.5
Introduction	.6
Features	.6
Controls & Functions	.7
Included with the DX834 Phone	.9
Important Electrical Considerations	.10
Range	.10
Telephone Line Problems	.10
Radio Interference	.10
More Than One Cordless Telephone	.10
Cordless Telephone Privacy	.10
Installation	.11
Selecting a Location	.11
Telephone Line Outlets	.11
Connecting the Telephone Cords	.11
Applying Power to the Base Unit	.11
Desk or Tabletop Installation	.12
Wall Installation	.13
Direct Wall Mounting	.13
Setting the Handset Retainer	.15
Setting Up Your Phone	.16
Extending the Antenna	.16
Installing the Handset Battery Pack	.16
Cleaning the Battery Contacts	.17
Charging the Battery Pack	.17
Low Battery Indicator	.18
Setting the Pulse/Tone Switch (Aus Model only)	.18
Adjusting Ringer Controls	.18
Adjusting Handset Receiver Volume	.18
Automatic Digital Code Security	.18
Using Your Phone	.19
Making and Receiving Calls	.19
Changing Channels, Flash and Page/Find	.19
Programming Your Phone	.20
Storing a Number in Memory	.20
Storing a Mixed Number	.20
Dialing a Stored Number	.21
Chain Dialing	.21
Erasing a Stored Number	.21
Troubleshooting	.22
Specifications	.23
Specification for Australian Model only	.23
Specification for New Zealand Model only	.24
Warranty	.25

Important Safety Instructions

When using your telephone equipment, these basic safety precautions should always be followed to reduce the risk of fire, electrical shock, and injury to persons:

1. Read and understand all instructions.
2. Follow all warnings and instructions marked on the product.
3. Unplug this product from the wall outlet before cleaning, and use a dry cloth, without liquid or aerosol cleaners.
4. Do not use this product near water; for example, near a bath tub, wash bowl, kitchen sink or laundry tub, in a wet basement or near a swimming pool.
5. Do not place this product on an unstable cart, stand or table. The telephone may fall, causing serious damage to the unit.
6. Slots and openings in the cabinet and the back or bottom are provided for ventilation. To protect the product from overheating, these openings must not be blocked or covered. This product should never be placed near or over a radiator or heat register. This product should not be placed in a built-in installation unless proper ventilation is provided.
7. This product should be operated only from the type of power source indicated on the marking label. If you are not sure of the type of power supply to your home, consult your dealer or local power company.
8. Do not allow anything to rest on the power cord. Do not locate this product where the cord will be damaged by persons walking on it.
9. Do not overload wall outlets and extension cords, as this can result in the risk of fire or electrical shock.
10. Never push objects of any kind into this product through cabinet slots, as they may touch dangerous voltage points or short out parts that could result in a risk of fire or electric shock. Never spill liquid of any kind on the product.
11. To reduce the risk of electric shock, do not disassemble this product. Take it to qualified service personnel when service or repair work is required. Opening or removing covers may expose you to dangerous voltages or other risks. Incorrect reassembly can cause electric shock when the appliance is subsequently used.
12. Unplug this product from the wall outlet and refer servicing to qualified service personnel under the following conditions:
 - A. If the power supply cord is damaged or frayed.
 - B. If liquid has been spilled into the product.
 - C. If the product has been exposed to rain or water.
 - D. If the product does not operate normally when following the operating instructions. (Adjust only those controls that are covered by the operating instructions. Improper adjustment of other controls may result in damage, and will often require extensive repair work by a qualified technician).
 - E. If the product has been dropped, or the cabinet has been damaged.
 - F. If the product exhibits a distinct change in performance.
13. Do not use the telephone to report a gas leak in the vicinity of the leak.

Battery Safety Precautions

CAUTION: *To reduce the risk of fire or injury to persons by the battery, read and follow these instructions.*

1. Use only the appropriate type and size Battery Pack specified in this Operating Guide.
2. Do not dispose of the Battery Pack in a fire. The cell may explode.
Check the Nickel-Cadmium Battery Disposal package insert for disposal instructions.
3. Do not open or mutilate the Battery Pack. Released electrolyte is corrosive and may cause damage to the eyes or skin. It may be toxic if swallowed.
4. Exercise care in handling the battery in order not to short the battery with conducting materials such as rings, bracelets and keys. The battery or conductor may overheat and cause burns.
5. Charge the Battery Pack provided with or identified for use with this product only in accordance with the instructions and limitations specified in the instruction manual provided for this product.
6. Observe proper polarity orientation between the Battery Pack and battery charger.

SAVE THESE INSTRUCTIONS

Introduction

Congratulations on your purchase of the Uniden DX834 Cordless Telephone. The DX834 is designed and engineered to exacting standards for reliability, long life and outstanding performance.

Features

- 10 Channels (Aus), 25 Channels (NZ)
- AutoSecure™
- Random Code™ Digital Security
- Handset Ringer/Volume Controls
- UltraClear Plus
- Pulse/Tone Dialing (Aus Model only)
- AutoTalk™
- AutoStandby™
- Voice Scramble
- 10-Number Memory
- 1-Way Page/Fine Button
- Redial/Flash Key
- 14 Day Battery Life

Voice Scramble protects your privacy by scrambling any call you make or receive. The RF signal between the Handset and Base Unit are changed, making it difficult or impossible for someone to receive and understand your phone calls.

AutoTalk™ allows you to answer a call by just removing the Handset from the Base so you don't have to waste time pushing buttons or flipping switches. **AutoStandby™** allows you to hang up by simply returning the Handset to the Base.







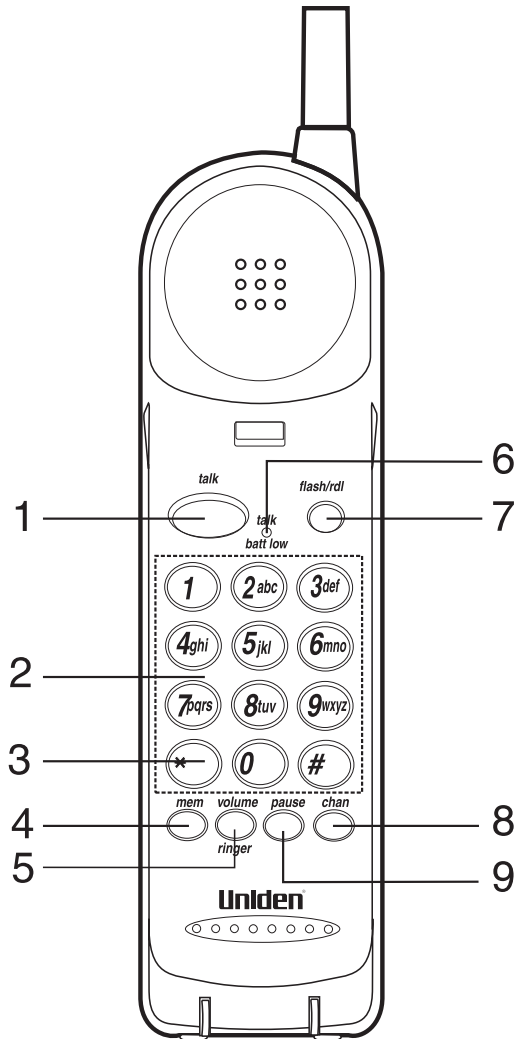

The UltraClear Plus innovative technology, together with multiple different channels, virtually eliminates background noise and provides you with the best possible reception during all of your conversations.

To protect you against misbilled calls which might result from your phone being activated by other equipment, **Random Code™** digital security automatically selects one of 65 thousand digital security codes for the Handset and Base Units. Also, the **AutoSecure™** feature electronically locks your phone when the Handset is in the Base.

To get the most from your phone, please read this Operating Guide thoroughly. Also be sure to complete the Products Registration form and mail it in.

Controls and Functions (Handset)



1. Talk Button 
2. Numeric Keypad
3. Tone Key  (Aus Model only)
4. Memory Key 
5. Ringer Volume  /Ringer Key 
6. Talk/Batt Low Indicator
7. Flash/Redial Key 
8. Channel Select Key 
9. Pause 

Controls and Functions (Base)

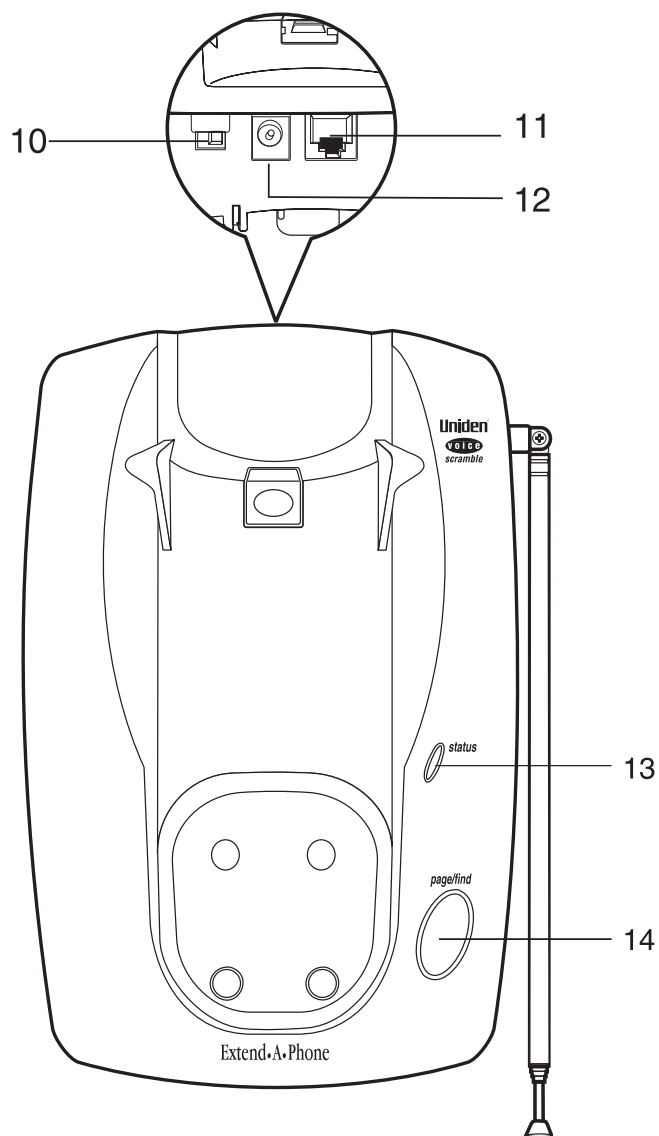

- 10. Tone Pulse Switch
- 11. Telephone Jack IN
- 12. AC Adapter Jack IN
- 13. Status (in use) Indicator
- 14. Page/Find Key

Included with the DX834 Phone

If any of these items are missing or damaged, contact the place of purchase.

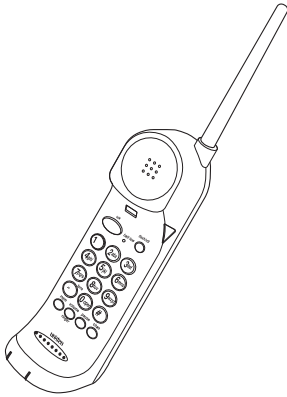

Handset

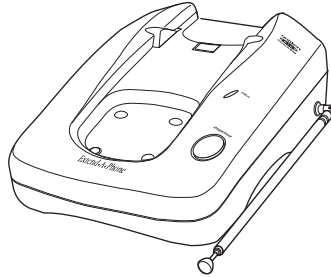

Base Unit

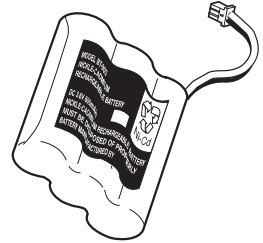

Rechargeable Battery



AC Adapter

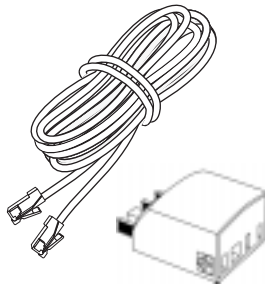

Telephone Cord
& P606 plug

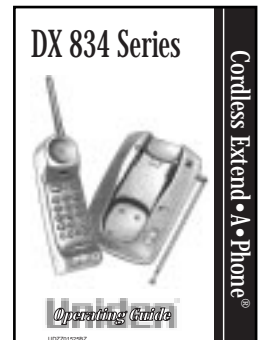

Operating Guide

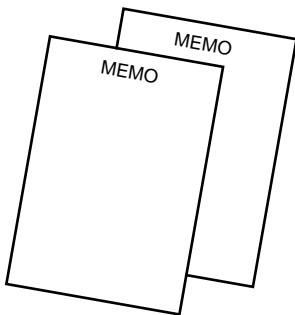

2 Memo Stickers

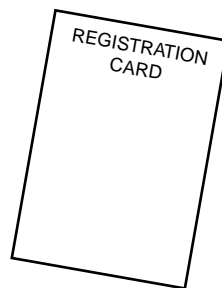

Registration Card

Important Electrical Considerations

Unplug all electrical appliances when you know an electrical storm is approaching. Lightning can pass through your household wiring and damage any device connected to it. This phone is no exception.

Warning: *Please do not attempt to unplug any appliance during an electrical storm.*

Caution: *Changes or modifications to this product not expressly approved by Uniden, or operation of this product in any way other than as detailed by this Operating Guide, could void your authority to operate this product.*

Range

Your new phone is designed to achieve the maximum possible range by transmitting and receiving according to the highest specifications. We have rated this phone to operate at a maximum distance with the qualification that the range depends upon the environment in which the telephone is used. Many factors limit range and it would be impossible to include all the variables in our rating. The Maximum Range rating of this phone is meant to be used as a means of comparison against other range claims.

Telephone Line Problems

If you are having trouble with your telephone service, you must first disconnect your phone to determine if it is the cause of your problem. If you determine that it is the cause, you must leave it disconnected until the trouble has been corrected.

Radio Interference

Radio interference may occasionally cause buzzing and humming in your cordless Handset, or clicking noises in the Base Unit. This interference is caused by external sources such as TV, refrigerator, vacuum cleaner, fluorescent lighting or electrical storm. Your unit is NOT DEFECTIVE. If these noises continue and are too distracting, please check around your home to see what appliances may be causing the problem. In addition, we recommend that the Base not be plugged into a circuit that also powers a major appliance because of the potential for interference. Be certain that the antenna on the unit is fully extended when needed.

In the unlikely event that you consistently hear other voices or distracting transmissions on your phone, you may be receiving radio signals from another cordless telephone or other source of interference. If you cannot eliminate this type of interference, press the channel key to select a channel that provides the clearest communication.

Finally, it should be noted that some cordless telephones operate at frequencies that may cause interference to nearby TVs and VCRs. To minimize or prevent such interference, the base of the cordless telephone should not be placed near or on top of a TV or VCR. If interference is experienced, moving the cordless telephone farther away from the TV or VCR will often reduce or eliminate the interference.

More Than One Cordless Telephone

If you want to use more than one cordless telephone in your home, they must operate on different channels. Press the channel key to select a channel that provides the clearest communication.

Cordless Telephone Privacy

Cordless telephones are radio devices. Communications between the Handset and base of your cordless telephone are accomplished by means of radio waves which are broadcast over the open airways. Because of the inherent physical properties of radio waves, your communications can be received by radio receiving devices other than your own cordless telephone unit. Consequently, any communications using your cordless telephone may not be private.

Installation

Selecting a Location

Before choosing a location for your new phone, there are some important guidelines you should consider:

- The location should be close to both a phone jack and power outlet.
- Keep the Base Unit and Handset away from sources of electrical noise such as motors or fluorescent lighting.
- Be sure there is sufficient space to fully extend the Base Unit antenna.
- The Base Unit can be placed on a desk or tabletop or wall mounted on the wall plate.
- If you decide to mount your phone on the wall, make sure to change the Handset Retainer so that the tab which holds the Handset faces up (see page ? for more information).
- You should charge your new phone for 15-20 hours before completing the installation or using the Handset.

Telephone Line Outlets:

Modular Jack

Most phone equipment available now uses modular jacks. Phone cords are fitted with a molded plastic connector which plugs into this type of jack. If you do not have modular phone jacks, contact your local telephone company for information about their installation.

Connecting the Telephone Cords

Consider these safety guidelines before connecting the telephone cords.

CAUTION!

- * Never install telephone wiring during a lightning storm.
- * Never touch uninsulated telephone wires or terminals unless the telephone line has been disconnected.
- * Use caution when installing or modifying telephone lines.

Applying Power to the Base Unit

The DX834 phone requires an uninterrupted AC outlet, and the included AC adapter. To relieve strain on the DC plug when the phone is placed on a desk or table, connect the adapter as shown below.

Wrap the power cord around the convenient notch on the bottom.

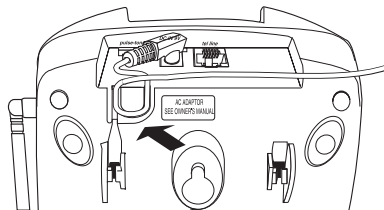

Important: Place the power cord so that it does not create a trip hazard or where it could become chafed and create a fire or other electrical hazards.

Desk or Tabletop Installation

1. Place the Base on a desk or tabletop.

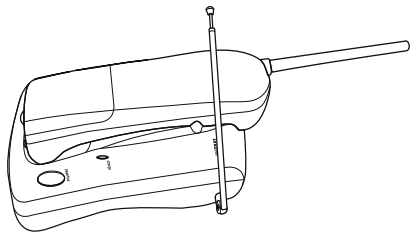

2. Plug the AC Adapter cord into the 9V DC input jack on the Base Unit.

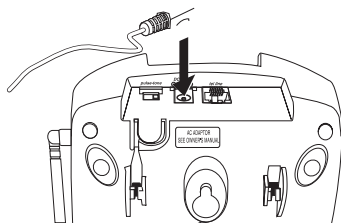

3. Place the AC Adapter cord around the strain relief.

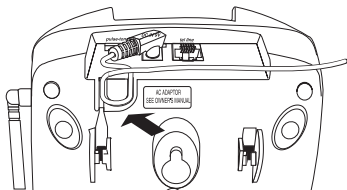

4. Plug one end of the long telephone cord into the TEL LINE jack on the Base Unit.

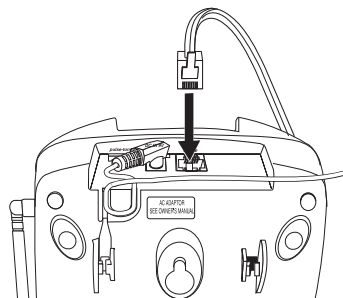

5. Plug the other end of the cord into the telephone jack on the wall.

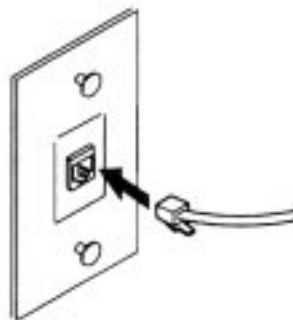

6. Plug the AC Adapter into a standard 230~240V AC wall outlet.

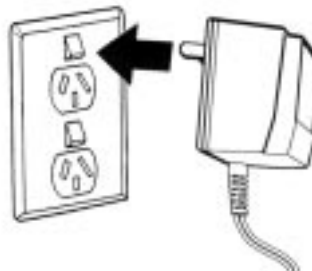

Wall Installation

Standard Wall Plate Mounting

These phones are designed to be mounted on a standard wall plate.

1. Plug the AC Adapter into the Base Unit.

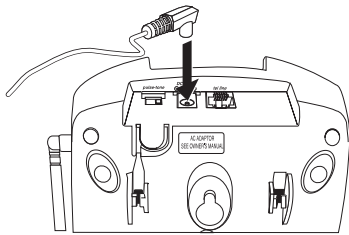

2. Place the AC Adapter cord inside the molded channel.

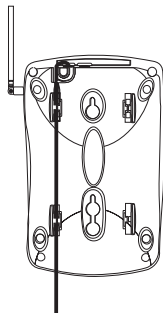

3. Plug one end of the short telephone cord into the TEL LINE jack on the Base Unit.

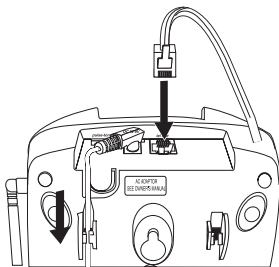

4. Place the telephone cord inside the molded channel on the bottom of the Base Unit. Then plug the other end of the telephone cord into the modular jack on the wall.

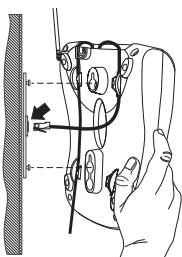

5. Place the Base Unit on the posts of the wall plate and push down until it's firmly seated.

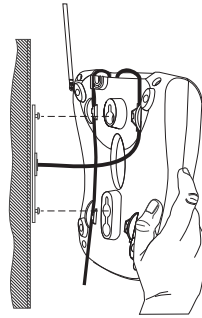

6. Plug the AC Adapter into a standard 230~240V AC wall outlet. Note: Do not use an outlet controlled by a wall switch.

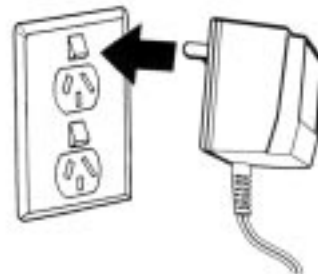

Direct Wall Mounting

If you do not have a standard wall plate, you can mount your phone directly on a wall. Before mounting your phone, consider the following:

* Select a location away from electrical cables, pipes or other items behind the mounting location that could cause a hazard when inserting screws into the wall.

* Make sure the wall material is capable of supporting the weight of the Base Unit and Handset.

* Use #10 screws with anchoring devices suitable for the wall material where the Base Unit will be placed.

1. Insert two mounting screws 100mm apart. Allow about 5mm between the wall and screw heads for mounting the phone.

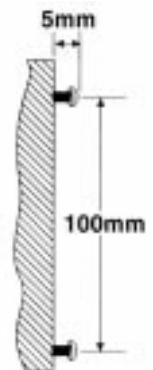

2. Plug the AC Adapter into the Base Unit

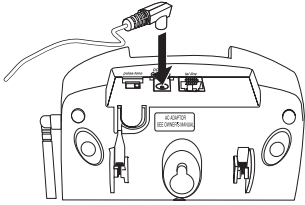

3. Place the AC Adaptor cord inside the molded channel.

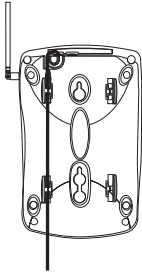

4. Plug one end of the long telephone cord into the TEL LINE jack on the Base Unit.

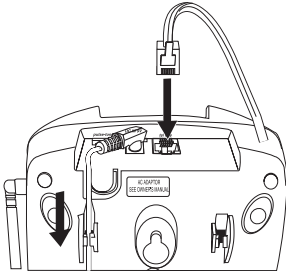

5. Place the cord inside the molded channel on the bottom of the Base Unit.

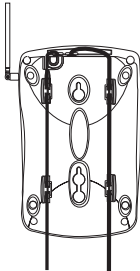

6. Place the Base Unit on the screws and push down until it's firmly seated.

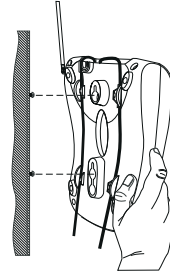

7. Plug the other end of the telephone line cord into the wall jack

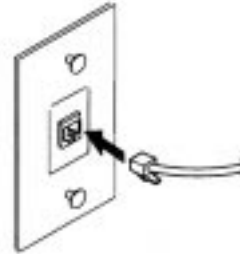

8. Plug the AC Adapter into a standard 230~240V AC wall outlet.

Note: Do not use an outlet controlled by a wall switch

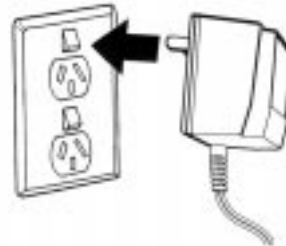

Setting the Handset Retainer

The Handset Retainer holds the Handset in place if your phone is mounted on a wall. The steps below describe how to remove and replace the retainer so that the tab faces up.

1. Push up on the Handset Retainer on the Base Unit and slide the tab out.

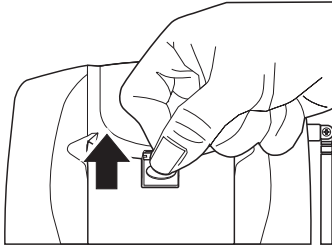

2. Flip the Retainer over so the tab faces up.

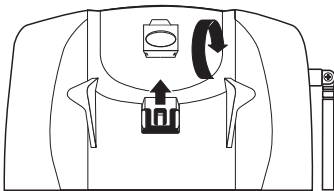

3. Push the Retainer back into its slot on the Base Unit.

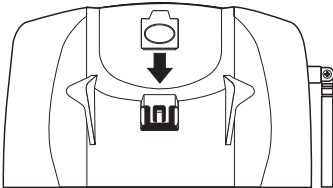

4. Push down on the Handset Retainer until it snaps into place.

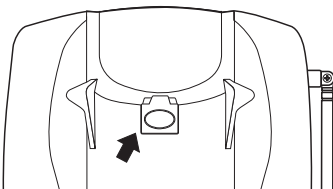

Setting Up Your Phone

Extending the Antenna

Before using your phone, be sure to raise its antenna to the vertical position. Then, fully extend the antenna.

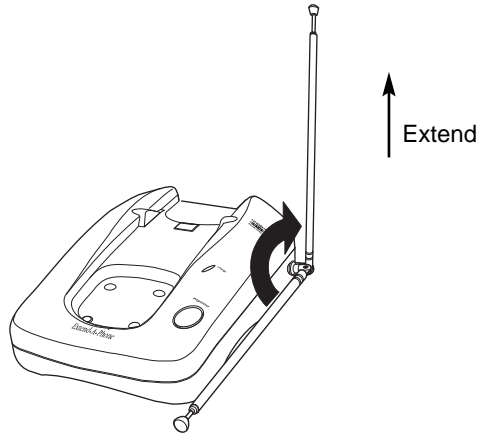

Installing the Handset Battery Pack

1. Press in on the Battery Cover Release



2. Slide the battery compartment cover down.

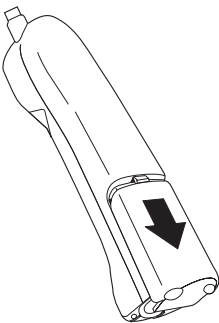

3. Align the plastic connector of the Nickel-Cadmium battery pack with its socket and plug it in.
Note: The black lead will be on the left when the plug is properly aligned

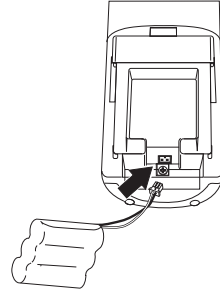

4. Place the battery pack inside the battery compartment and slide the battery cover back on.
Note: The built-in Memory Backup feature allows up to 3 minutes to disconnect the old battery pack and install a new one without losing any numbers stored in memory.

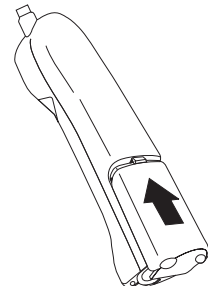

Cleaning the Battery Contacts

To maintain a good charge, it is important to clean all charging contacts on the Handset and Base Unit about once a month. Use a pencil eraser or other contact cleaner. Do not use any liquids or solvents.



Charging the Battery Pack

Initial Battery Charging

The rechargeable Nickel-Cadmium battery pack must be fully charged before using your phone for the first time. We recommend that the battery pack charge for approximately 15-20 hours, without interruption, before plugging the phone into your new phone.

1. Place the Handset on the Base Unit. Either place the Handset with ear piece in the cradle

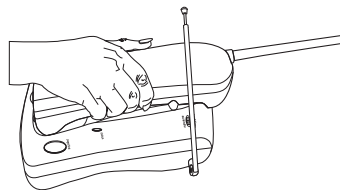

- OR -

Place the Handset in the cradle with it standing on end (desk mount only).

Note: Make sure to change the Handset Retainer before hanging up the phone (wall mounted bases).



Battery Memory Effect

Rechargeable batteries can develop a "memory" (reduced charge capacity) caused by repeated charge and discharge cycles. The battery life will seem to be shorter everytime you use the unit.

To Avoid this Memory Effect

At least once a month, operate the unit until the "Battery Low" indicator appears. Then recharge the battery for a full 15-20 hours. Avoid putting the Handset back in the base after using the phone for a short time. This could cause "topping off" the charge. Also, do not charge the Rechargeable Battery for extended period of time.

Low Battery Indicator

When the Battery Pack in the Handset is very low and needs to be charged, the TALK/BATT LOW LED flashes.

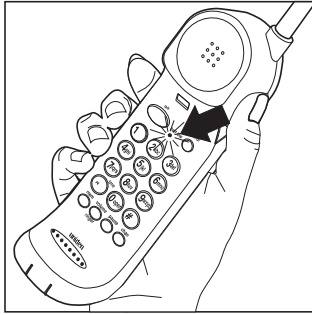

If the TALK/BATT LOW LED begins to flash, the phone is programmed to eliminate its functions to save power. The table below describes what to do to return your phone to normal operation.

During a Call	In Standby Mode
Only the TALK button operates.	None of the buttons will operate.
The Handset beeps and the TALK/BATT LOW LED flashes once every 3 seconds.	The Handset beeps and the TALK/BATT LOW LED flashes once every 3 seconds.
Complete your call as quickly as possible.	You will not be able to make a call.
Return the Handset to the Base Unit for charging.	Return the Handset to the Base Unit for charging.

Note: Allow 15-20 hours without any interruption for the Handset to fully recharge.

Setting the Pulse-Tone Switch (Australian Model only)

Be sure the PULSE/TONE switch is in the TONE position.

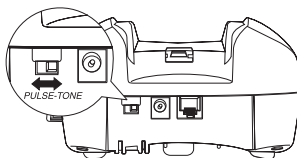

Note: Most phone systems are Tone Dialing. Check with your local phone company if you are not sure whether your system is Tone or Pulse dialing.

Adjusting Ringer Controls

To adjust the **ringer** volume of your Handset, press ringer when the phone is not in use..

You can also select one of two different ringer tones for the Handset.

Press **ringer** to select a different ringer tone when the phone is not in use.

Adjusting Handset Receiver Volume

Volume settings are Normal and High. When the Handset is first picked up, the volume will be at the normal setting. Pressing the **volume** will change the volume to High. This can be accomplished during a call.

Automatic Digital Code Security

To avoid unauthorised calls on your phone, a Digital Code feature was added to the DX834 phone. This Digital Code is shared only between the Handset and Base Unit. The code is set automatically when you first charge the phone.

To change the Digital Code, be sure the Handset is on the Base, then:

1. Remove the Handset from the Base Unit.
2. Press the PAGE/FIND button on the Base Unit.
3. Place the Handset back on the Base Unit while it is still beeping.

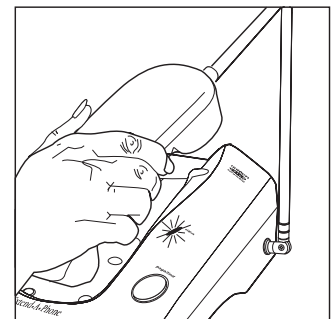

4. When the beeping stops, briefly remove the Handset again, and then return it to the Base Unit.

Note: If the Base Unit loses power while the Handset is off the Base, the Digital Code may be erased. When this happens, the Handset will not function.









To re-establish communication between the Handset and Base Unit:



1. Restore power to the Base Unit.
2. Place the Handset back on the Base Unit.
3. The CHARGE LED will blink to indicate that the Digital Security Code is set.

Using Your Phone

Making and Receiving Calls









The following features of the DX834 phone are different depending on the Handset's location when you make or receive a call.





	Handset On Base	Handset Off Base
Answer Call	Pick up Handset (AutoTalk)	Press  .
Make Call	<ol style="list-style-type: none"> 1) Pick up Handset. 2) Press . 3) Listen for dial tone. 4) Dial the number. 	<ol style="list-style-type: none"> 1) Press . 2) Listen for dial tone. 3) Dial the number.
Hang Up	Return Handset to Base. (AutoStandby)	Press  .
Redial	<ol style="list-style-type: none"> 1) Pick up Handset. 2) Press . 3) Listen for dial tone. 4) Press . 	<ol style="list-style-type: none"> 1) Press . 2) Listen for dial tone. 3) Press .

Note: Sometimes when you press  to hang up the phone, you may get an error tone and the phone will not disconnect. If this happens, place the Handset on the base Unit or press  again while holding the Handset close to the Base Unit.

Changing Channels, Flash and Page/Find

To change channels or access call waiting while the phone is in use, or to use the one-way page to locate the Handset, follow these steps:

	Press These Keys	You Will Hear
Changing Channels	Press  . Note: Change channels to help eliminate background noise.	A click similar to when  is pressed. There may be a brief pause as your phone searches for a clear channel.
Flash	If the call waiting tone sounds, press  to accept the waiting call -OR- If you have finished a call and want to make another call, press  to hang up and get a dial tone. (For Australia*) If the Call Waiting sounds, press  key then  to accept the waiting call and put the current call on hold. To switch back to the original call, press  key then  .	A click, a short pause, then the caller (if you were on a call). -OR- A click, and then a dial tone so you can make a different call. A click, a short pause, then the waiting caller. A click, a short pause, then the caller on hold.
Page/Find	Press Page/Find on the Base Unit to locate the Handset.	The Handset will beep more than 5 times.

Note: The  +  call waiting procedure toggles the call between the incoming call and the original call (vice versa). The  +  procedure will drop the current call connection and pick up the incoming call or the call on hold.

Programming Your Phone

All programming functions must be completed when your phone is in the standby mode because programming keys do not function while you are on the phone.

Storing A Number in Memory



Use these keys to store a number in memory.

Note: An error tone will sound and the programming procedure will be canceled if more than 20 seconds elapse between each keystroke entry or step.

1. Remove the Handset from the Base Unit.
2. Press  .
The **TALK/BATT LOW** LED blinks.
3. Enter the number you want to store (up to 16 digits).



4. If a pause is needed during dialing to access a long distance service, press  .

Note: The  button counts as one digit. Pressing  more than once increases the length of the pause between numbers.

5. Press  again.
6. Enter the memory location (0-9).
A tone indicates that the number is stored.

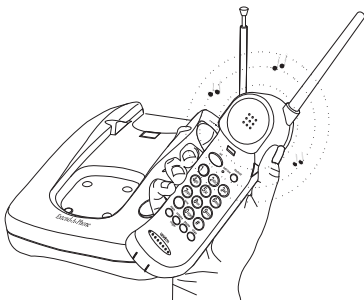

Storing a Mixed Number

If your phone is set up for Pulse dialing, you can store a mixed mode number so that you can easily access long distance services. Use these keys to store a mixed mode number in memory.

Note: An error tone will sound and the programming procedure will be canceled if more than 20 seconds elapse between each keystroke entry or step.

1. Remove Handset from the Base Unit.
2. Press  .
The **TALK/BATT LOW** LED blinks.

3. Enter the number to be dialed in pulse mode.





4. Press  on the Handset.

5. Enter the number to be dialed in tone mode.



6. If a pause is needed during dialing to access a long distance service, press  .



Note: The  button counts as one digit. Pressing  more than once increases the length of the pause between numbers.

7. Press  again.
8. Enter the memory location (0-9).
A tone indicates that the number is stored.

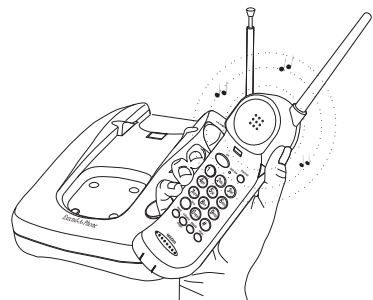

Dialing a Stored Number

To dial a number previously stored in memory, follow these steps:

1. Remove the Handset from the Base Unit.

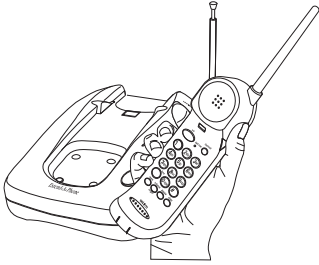

2. Press **CALL**.
3. Press **MEMORY**.
4. Press the memory location number (0-9).

Chain Dialing

On certain occasions, after dialing a number, you may be requested by the party or service you are calling to enter a special access code, such as when performing a banking transaction.

To do this, simply:

1. Store the access code into one of the memory numbers.
2. Dial the main number.
3. At the appropriate time, press **MEMORY** followed by the memory location number where the access code is saved.

Erasing a Stored Number

To erase a number previously stored in a memory location (0-9), follow these steps:

1. Remove the Handset from the Base Unit.

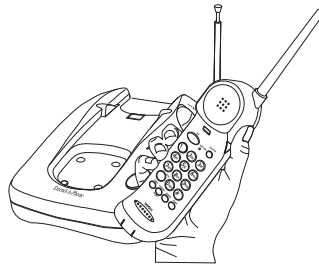

2. Press **MEMORY** twice.
3. Press the memory location number (0-9).

Note: An error tone will sound and the erase procedure will be canceled if more than 20 seconds elapse between each keystroke entry or step.

Troubleshooting

If your DX834 Cordless Telephone is not performing to your expectations, please try these simple steps. If you are still unable to resolve the problems, contact Uniden Customer Service for assistance.

Problem	Suggestion
Charge light won't come on when Handset is placed in Base Unit.	<ul style="list-style-type: none">• Make sure the AC Adapter is plugged into the Base Unit and wall outlet.• Make sure Handset is properly seated in Base Unit.• Make sure that the charging contacts on the Handset and Base Unit are clean.
Audio sounds weak and/or scratchy.	<ul style="list-style-type: none">• Make sure that the Base Unit antenna is fully vertical and extended.• Move the Handset and/or Base Unit to different locations and try again.• Press the chan button to select another channel.
Can't make or receive calls.	<ul style="list-style-type: none">• Check both ends of the Base Unit telephone line cord.• Make sure the AC Adapter is plugged into the Base Unit and wall outlet.• Disconnect the AC Adapter for a few minutes and then reconnect it.
Handset doesn't ring or receive a page.	<ul style="list-style-type: none">• Nickel-Cadmium battery pack may be weak. Charge the battery on the Base Unit for 15-20 hours.• Extend the Base Unit antenna vertically.• The Handset may be too far away from the Base Unit.• Place the Base Unit away from noise sources.• The Digital Security Code may be erased. Set the Digital Code.

Specifications (For Australian Model only)

General	Frequency Control:	Phase Locked Loop (PLL) synthesiser.
	Modulation:	FM
	Operating Temperature	-10° to 50°C
	Scrambler	Frequency Inversion
	Compliance	TS001, TS002, TS004, AS/NZS3548,
	AS/NZS3260, AS/NZS4281	

Base Unit	Receive Frequency:	39.775 ~ 40.000 Mhz (10 Channel)
	Transmit Frequency:	30.075 ~ 30.300 Mhz (10 Channel)
	Power Source:	AAD 600S AC Adapter
		Approval Number N13809
		Output: 9V DC - 210 mA
		Input: 230 ~ 240V AC 50 Hz
	Size:	123mm(W) x 188mm(D) x 57mm(H)
	Weight:	Approx. 536g

Handset	Receivet Frequency:	30.075 ~ 30.300 Mhz (10 Channel)
	Transmit Frequency:	39.775 ~ 40.000 Mhz (10 Channel)
	Power Requirements:	Rechargeable Nickel-Cadmium Battery
	Size:	50mm(W) x 57mm(D) x 305mm (H) (with Antenna)
	Weight:	Approx. 284g (including battery)
	Battery:	CTA885 (BT161)
	Capacity:	270 mAH 3.6V
	Talk Mode:	6 hours
	Standby Mode:	14 Days

Specifications, Features and availability of Optional Accessories shown are typical and subject to change without notice.

Specifications (For New Zealand Model only)

General	Frequency Control:	Phase Locked Loop (PLL) synthesiser.
	Modulation:	FM
	Operating Temperature	-10° to 50°C
	Scrambler	Frequency Inversion
	Compliance	RFS30, PTC200

Base Unit

Receive Frequency:	39.775 ~ 40.475 Mhz (25 Channel)
Transmit Frequency:	30.075 ~ 30.775 Mhz (25 Channel)
Power Source:	AAD 600S AC Adapter (CTA886) Approval Number N13809 Output: 9V DC - 210 mA Input: 230 ~ 240V AC 50 Hz
Size:	123mm(W) x 188mm(D) x 57mm(H)
Weight:	Approx. 536g

Handset

Receivet Frequency:	30.075 ~ 30.775 Mhz (25 Channel)
Transmit Frequency:	39.775 ~ 40.475 Mhz (25 Channel)
Power Requirements:	Rechargeable Nickel-Cadmium Battery
Size:	50mm(W) x 57mm(D) x 305mm (H) (with Antenna)
Weight:	Approx. 284g (including battery)
Battery:	CTA885 Capacity: 270 mAh 3.6V Talk Mode: 6 hours Standby Mode: 14 Days

Specifications, Features and availability of Optional Accessories shown are typical and subject to change without notice.

Warranty

One-Year Limited Warranty

Important: Evidence of original purchase is required for warranty service.

WARRANTOR: Uniden Australia Pty Limited ACN 001 865 498
Uniden New Zealand Limited

ELEMENTS OF WARRANTY: Uniden warrants to the original retail owner for the duration of this warranty its DX8200 (hereinafter referred to as the Product), to be free from defects in materials and craftsmanship with only the limitations or exclusions set out below.

WARRANTY DURATION: This warranty to the original retail owner only, shall terminate and be of no further effect 12 months after the date of original retail sale. This warranty will be deemed invalid if the product is: (A) Damaged or not maintained as reasonable and necessary, (B) Modified, altered or used as part of any conversion kits, subassemblies, or any configurations not sold by Uniden, (C) Improperly installed, (D) Repaired by someone other than an authorised Uniden Repair Agent for a defect or malfunction covered by this warranty, (E) Used in conjunction with any equipment or parts or as a part of a system not manufactured by Uniden.

PARTS COVERED: This warranty covers for one (1) year, the Base/Charging Unit and Handset only. All accessories (AC Adapter, Cable, Modular Plug, etc) are covered for 90 days only.

STATEMENT OF REMEDY: In the event that the product does not conform to this warranty at any time while this warranty is in effect, the warrantor, at its discretion, will repair the defect or replace the product and return it to you without charge for parts and service. **THIS WARRANTY DOES NOT COVER OR PROVIDE FOR THE REIMBURSEMENT OR PAYMENT OF INCIDENTAL OR CONSEQUENTIAL DAMAGES. THIS GUARANTEE IS IN ADDITION TO AND DOES NOT IN ANY WAY AFFECT YOUR RIGHTS UNDER THE CONSUMER GUARANTEE ACT.**

WARRANTY CARD: If a Warranty Card has been included with this Product, please complete and return to us within 14 days of purchase. Your name and the serial number of the Product will then be registered in our database and this will help us process your claim with greater speed and efficiency should you require warranty service.

PROCEDURE FOR OBTAINING PERFORMANCE OF WARRANTY: In the event that the product does not conform to this warranty, the Product should be shipped or delivered, freight pre-paid, with evidence of original purchase (e.g. a copy of the sales docket) to the warrantor at:

UNIDEN AUSTRALIA PTY LIMITED

SERVICE DIVISION

345 Princes Highway, Rockdale, NSW 2261

Ph: (02) 9599 3577 Fax: (02) 9599 3278

FREE CALL 1800 632 789

Customers in other States should ship or deliver the Product freight pre-paid to their nearest Uniden Authorised Repair Centre. (Contact Uniden for the nearest Warranty Agent to you)

UNIDEN NEW ZEALAND LIMITED

SERVICE DEPARTMENT

150 Harris Road, East Tamaki, Auckland

Ph: 0-9-273 8383 Fax: 0-9-274 0009

Toll Free: 0800 4 UNIDEN

4 8 6 4 3 3 6

Customers in other States should ship or deliver the Product freight pre-paid to their nearest Uniden Authorised Repair Centre. (Contact Uniden for the nearest Warranty Agent to you)

Uniden[®]

A Clear Signal of What's Ahead.

UNIDEN ©1998 Uniden Australia Pty Limited ©1998 Uniden New Zealand Limited
All Rights Reserved.

Free Manuals Download Website

<http://myh66.com>

<http://usermanuals.us>

<http://www.somanuals.com>

<http://www.4manuals.cc>

<http://www.manual-lib.com>

<http://www.404manual.com>

<http://www.luxmanual.com>

<http://aubethermostatmanual.com>

Golf course search by state

<http://golfingnear.com>

Email search by domain

<http://emailbydomain.com>

Auto manuals search

<http://auto.somanuals.com>

TV manuals search

<http://tv.somanuals.com>