



E X A 7 9 5 0

# OWNER'S MANUAL

900 MHz Cordless

Phone with Digital

Answering System

**Uniden**<sup>®</sup>

# CONTENTS

## NOTE

Fold out the back cover of this owner's manual to use the handy "Controls and Functions" page for reference.

## CONTENTS OF YOUR OWNER'S MANUAL

<b>Controls and Functions</b> . . . . .	<b>Back Cover Fold-out</b>
<b>Introduction</b> . . . . .	<b>1</b>
• Welcome . . . . .	1
• Features . . . . .	1
• Included in Your Package . . . . .	2
<b>Installing and Adjusting Your Phone</b> . . . . .	<b>3</b>
• Desk/Tabletop Installation . . . . .	3
• Wall Installation . . . . .	4
• Installing the Handset Battery Pack . . . . .	8
• Charging the Battery Pack . . . . .	8
• Cleaning the Battery Contacts . . . . .	9
• Page . . . . .	9
• Setting the Pulse/Tone Switch . . . . .	10
• Adjusting the Ringer Controls . . . . .	10
• Automatic Digital Code Security . . . . .	11
<b>Using Your New Phone</b> . . . . .	<b>12</b>
• Making and Receiving Calls . . . . .	12
• Flash and Call Waiting . . . . .	12
• Storing a Phone Number in Memory . . . . .	13
• Dialing a Stored Number . . . . .	13
• Chain Dialing . . . . .	14
• Erasing a Stored Number from Memory . . . . .	14
• Redial . . . . .	15
• Tone . . . . .	15
• Traveling Out-of-Range . . . . .	15
• Channel . . . . .	15
• Using the SpeakerPhone . . . . .	15
• Three-way call . . . . .	15
<b>Setting Up the Integrated Answering Device</b> . . . . .	<b>16</b>
• The Integrated Answering Device . . . . .	16
• Features . . . . .	16
• Turning the Answering System On/Off . . . . .	17
• Setting the Clock . . . . .	17
• Setting Your Outgoing Message (GREETING) . . . . .	18
• Selecting the Message Record Time . . . . .	19
• Selecting a Pin Code . . . . .	20
• Calling Party Control Feature . . . . .	20
• Setting the Toll Saver Switch . . . . .	21
• Using the Reset Button . . . . .	21
<b>Using the Integrated Answering Device</b> . . . . .	<b>22</b>
• Playing Your Messages . . . . .	22
• Repeating a Message . . . . .	22
• Skipping a Message . . . . .	23
• Deleting a Message . . . . .	24
• Voice Memo . . . . .	24
• Recording a Conversation . . . . .	25
• Remote Access Away from Home . . . . .	25
• Remote Room Monitor . . . . .	27
<b>Troubleshooting</b> . . . . .	<b>28</b>
• Quick Reference Chart . . . . .	28
<b>Specifications</b> . . . . .	<b>31</b>

### WELCOME

Congratulations on your purchase of the Uniden EXA7950 cordless telephone and answering system. This phone is designed and engineered to exacting standards for reliability, long life, and outstanding performance.

### FEATURES

- 900 MHz Extended Range Technology
- Integrated Telephone Answering Device (ITAD)
- 10 Number Memory Dialing
- 3 Instant Dial Priority Keys
- 32 Digit Redial
- Flash and Pause
- Pulse/Tone Dialing
- Page
- 7 Hour Talk Time
- Handset Earpiece and Ringer Volume Control
- Hearing Aid Compatible

The EXA7950 features include *AutoTalk™* and *AutoStandby™*. *AutoTalk* allows you to answer a call by just removing the handset from the base so you don't have to waste time pushing buttons or flipping switches. *AutoStandby* allows you to hang up by simply returning the handset to the base.

The *UltraClear Plus™* true compander circuitry virtually eliminates background noise. This innovative technology, together with 40 different channels, provides you with the best possible reception during all your conversations.

To protect you against misbilled calls which might result from your phone being activated by other equipment, the EXA7950 has *Random Code™* digital security which automatically selects one of over 65,000 digital security codes for the handset and base. Also, the *AutoSecure™* feature electronically locks your phone when the handset is in the base.

To get the most from your phone, please read this owner's manual thoroughly. Also, be sure to complete the product registration form and mail it in.

**Be sure to visit our web site at: [www.uniden.com](http://www.uniden.com).**

## TIP

To get the most from your phone, please read this owner's manual thoroughly. Also be sure to complete and mail the product registration form.

## NOTE

If any of these items are missing or damaged, contact the Uniden Parts Department at (800) 554-3988. Hours are from 8:30 a.m. to 5:00 p.m. Central Time, Monday through Friday. We can also be reached on the web at [www.uniden.com](http://www.uniden.com).

## INCLUDED IN YOUR PACKAGE

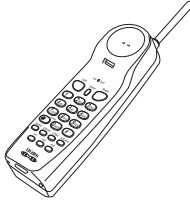

Handset

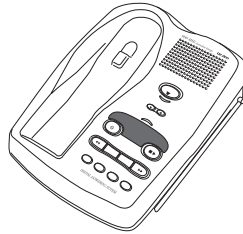

Base

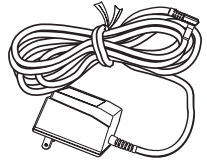

AC Adapter

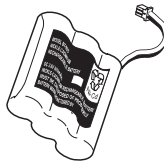

Rechargeable Battery



Telephone Cord

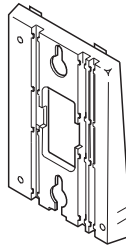

Wall Mount Adapter

Also included:

- This Owner's Manual
- Precautions and Important Safety Instructions/Warranty Information
- Registration Card

## TIP

Before choosing a location for your phone, read the "Installation Considerations" included in the "Precautions and Important Safety Instructions" brochure.

## DESK/TABLETOP INSTALLATION

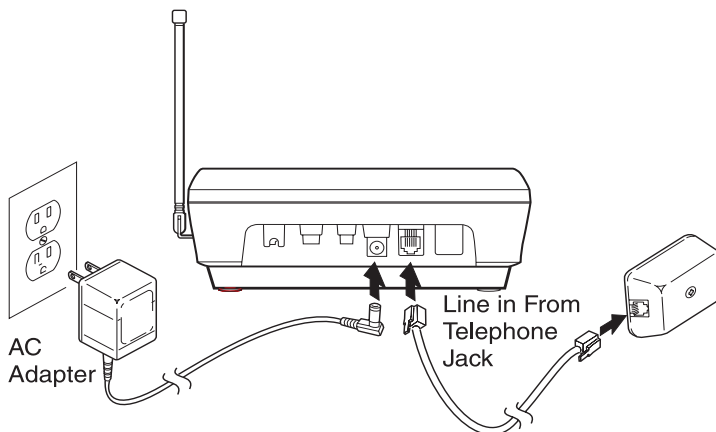

- 1) Plug the AC adapter cord into the 9 VDC input jack on the back of the base.
- 2) Wrap the AC adapter cord around the strain relief notch.



*Place the power cord so that it does not create a trip hazard or where it could become chafed and create a fire or electrical hazard.*

- 3) Plug the AC adapter into a standard 120 VAC wall outlet.



*Use only the Uniden AC adapter supplied with this phone and DO NOT use an outlet controlled by a wall switch.*

- 4) Charge the battery (refer to "Charging the Battery Pack," page 8).
- 5) Plug one end of the telephone cord into the **TEL LINE** jack on the back of the base.
- 6) Plug the other end of the cord into your telephone jack on the wall.

## HINT

Before using your phone, fully charge the Nickel-Cadmium battery pack for 15-20 hours.

## CAUTION

Place the power cord so that it does not create a trip hazard or where it could become chafed and create a fire or electrical hazard.

- 7) Set the base on a desk or tabletop, and place the handset into the base as shown. Then, raise the antenna to a vertical position.

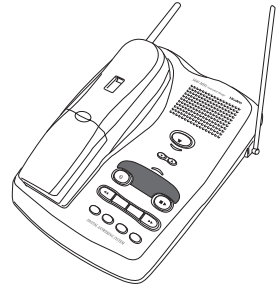

## WALL INSTALLATION

### ▼ *Standard wall plate mounting*

This phone can be mounted on any standard AT&T or GTE wall plate.

- 1) Slide the wall mount adapter into the notches at the top of the base.
- 2) Rotate the wall mount adapter down and snap it into place at the bottom of the base.

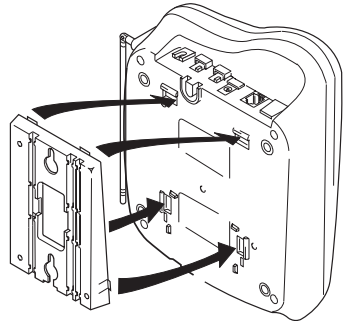

- 3) Plug the AC adapter into the base.
- 4) Put the AC adapter cord inside the molded wiring channel, then wrap it around the strain relief notch. Plug the AC adapter into a standard 120 VAC wall outlet.

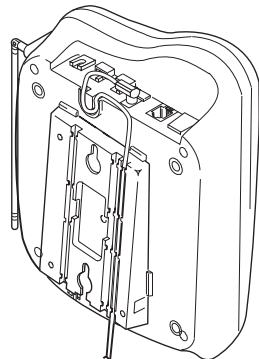



DO NOT use an outlet controlled by a wall switch.



Before you plug the other end of the telephone cord into the modular jack on the wall, charge the battery (refer to "Charging the Battery Pack," page 8).

- 5) Plug one end of the telephone cord into the **TEL LINE** jack on the back of the base, then plug the other end into a standard telephone jack.
- 6) Line up the mounting slots on the base with the mounting posts on the wall, then push in and down until the phone is firmly seated.

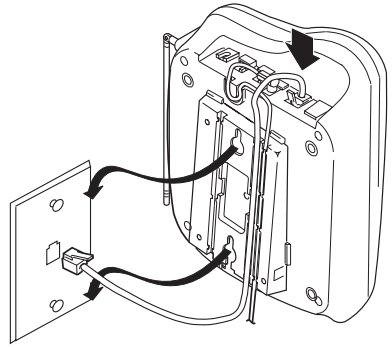

- 7) On the base unit, pull the handset retainer out of the slot and rotate it clockwise 180 degrees.

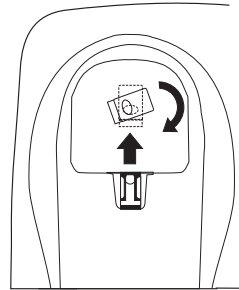

- 8) Flip the retainer from front to back, then slide it back into the slot so that the lip of the retainer faces up and the oval is at the bottom of the retainer. This will hold the handset in place.

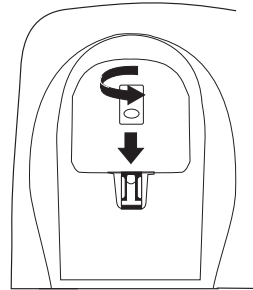

### ▼ *Direct wall mounting*

If you don't have a standard wall plate, you can mount your phone directly to the wall. Before doing this, consider the following:

- Select a location away from electrical cables, pipes, or other items behind the mounting location. Inserting screws into areas such as this can be hazardous.
- Try to mount your phone within 10 - 15 feet of a working phone jack in order to avoid excessive lengths. Remember, you are not mounting your phone to a wall plate with a built-in phone jack.
- If the selected mounting area has no wooden support beams directly behind it, you will need the appropriate anchoring devices in order for the wall to properly support your phone.

- 1) Insert two mounting screws into the wall, with their appropriate anchoring device if necessary,  $3\text{-}15/16$  inches apart. Allow about  $3/16$  of an inch between the wall and screw heads for mounting the phone.

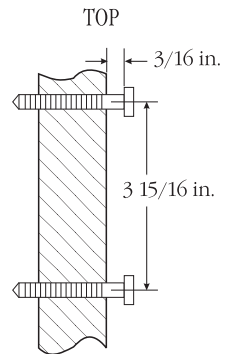

- 2) Slide the wall mount into the notches at the top of the base.
- 3) Rotate the wall mount adapter down and snap it into place at the bottom of the base.

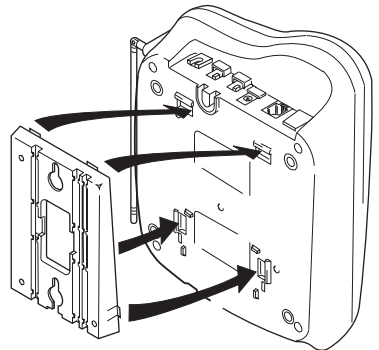

- 4) Plug the AC adapter into the base.



- 5) Put the AC adapter cord inside the molded wiring channel, then wrap the AC adapter cord around the strain relief notch. Plug the AC adapter into a standard 120 VAC wall outlet.

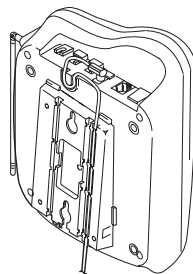

- 6) Plug one end of the telephone cord into the **TEL LINE** jack on the back of the base, then plug the other end into a standard telephone jack.

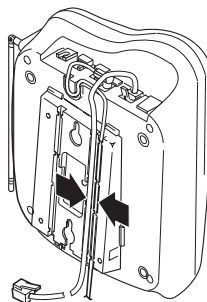

- 7) Line up the mounting slots on the base with the mounting screws on the wall, then push in and down until the phone is firmly seated.

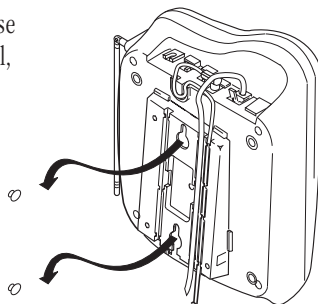

- 8) On the base unit, pull the handset retainer out of the slot and rotate it clockwise 180 degrees.

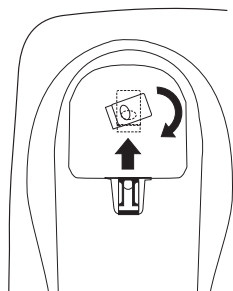

- 9) Flip the retainer from front to back, then slide it back into the slot so that the lip of the retainer faces up and the oval is at the bottom of the retainer. This will hold the handset in place.

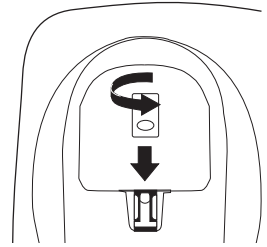

## INSTALLING THE HANDSET BATTERY PACK

- 1) Remove the handset battery cover.
- 2) Plug the battery's cable into the handset
- 3) Replace the battery cover.

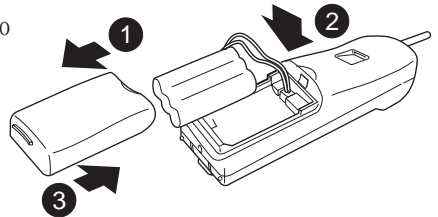

### NOTE

*The plastic connectors will fit together only one way. Make sure the battery's connector is properly aligned. Use only the Uniden battery pack (model BT-905).*

## CHARGING THE BATTERY PACK

### ▼ Initial battery charging

Before plugging the phone line into your new phone for the first time, fully charge the rechargeable battery pack for 15-20 hours *without interruption*.

- 1) Place the handset on the base.
- 2) Make sure that the **status** LED lights. If the LED doesn't light, check to see that the AC adapter is plugged in and that the handset makes good contact with the base charging contacts.



Use only the Uniden battery (BT-905) supplied with your phone.

### ▼ *Low battery indicator*

When the battery pack is very low and needs to be charged, the phone is programmed to eliminate functions in order to save power. If the phone is not in use, the **talk/batt** LED flashes every three seconds.

If the phone is in use, the **talk/batt** LED flashes every three seconds and the handset beeps. Complete your conversation as quickly as possible and return the handset to the base for charging.

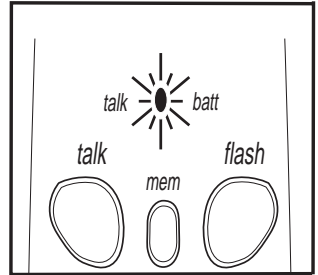

## CLEANING THE BATTERY CONTACTS

To maintain a good charge, clean all charging contacts on the handset and base about once a month with a pencil eraser or other contact cleaner. DO NOT use liquids or solvents; you may damage your phone.

## PAGE

To locate the handset (while it's off the base), press **page** on the base. The handset beeps for 60 seconds.

Paging is canceled, when the handset is returned to the base.

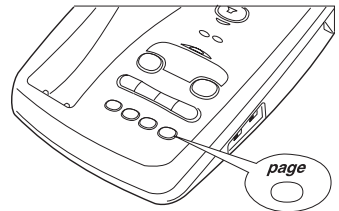

## TIP

Most phone systems use tone dialing. Check with your local phone company if you're not sure whether your system is tone or pulse.

## SETTING THE PULSE/TONE SWITCH

Be sure the **PULSE/TONE** switch is in the **TONE** position unless your local phone system uses pulse dialing.

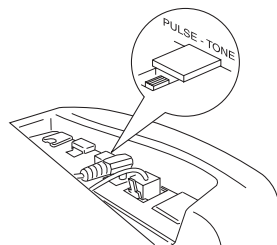

## ADJUSTING THE RINGER CONTROLS

### ▼ *Handset ringer tone and ringer volume*

When the phone is either charging or in standby mode, pressing the **volume** key on the handset selects the handset ringer volume and tone. There are two ringer tones each with two volume levels; high and low.

### ▼ *Handset earpiece volume*

The handset earpiece volume settings (Normal, High and Loud) can only be adjusted during a call. Press **volume** to select Normal, High or Loud. When you hang up, the phone keeps the last volume setting selected.

### ▼ *Base unit ringer on-off*

To turn the base ringer on, select the **RINGER ON** position. To turn the base ringer off, select the **RINGER OFF** position.

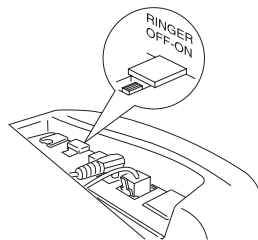



## AUTOMATIC DIGITAL CODE SECURITY

To prevent other parties from making unauthorized calls on your phone line, a digital code was added to the EXA7950. Your phone's handset and base share this code, which is randomly set each time you place the handset in the charging cradle.

▼ *To reestablish communication between the handset and the base in the event of a power failure*

- 1) Restore power to the base.
- 2) Place the handset on the base. The **status** LED blinks to indicate that the digital security code is reset.

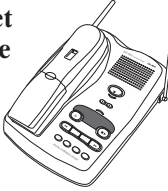
### MAKING AND RECEIVING CALLS

	<b>Handset On Base</b> 	<b>Handset Off Base</b> 
To answer a call	Pick up the handset, or press <b>speaker</b> on the base.	Press any button or press <b>speaker</b> on the base..
To make a call	<ol style="list-style-type: none"> <li>1) Pick up the handset.</li> <li>2) Press <b>talk</b>.</li> <li>3) Listen for the dial tone.</li> <li>4) Dial the number.</li> </ol>	<ol style="list-style-type: none"> <li>1) Press <b>talk</b>.</li> <li>2) Listen for the dial tone.</li> <li>3) Dial the number.</li> </ol>
To hang up	Press <b>talk</b> , or return the handset to the base (AutoStandby), or press <b>speaker</b> .	Press <b>talk</b> , or return the handset to the base (AutoStandby).
To redial	<ol style="list-style-type: none"> <li>1) Pick up the handset.</li> <li>2) Press <b>talk</b>.</li> <li>3) Listen for the dial tone.</li> <li>4) Press <b>redial</b>.</li> </ol>	<ol style="list-style-type: none"> <li>1) Press <b>talk</b>.</li> <li>2) Listen for the dial tone.</li> <li>3) Press <b>redial</b>.</li> </ol>

### FLASH AND CALL WAITING

If you have “call waiting” service and a call waiting tone sounds while you are on a call, press **flash** to accept the waiting call. There is a short pause, then you will hear the new caller. To return to the original caller, press **flash** again.

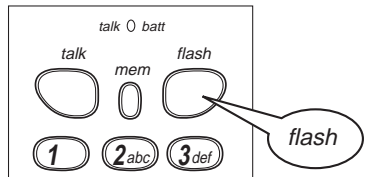

## NOTE

The pause button counts as one digit. Pressing **pause** more than once increases the length of pause between numbers.

## STORING A PHONE NUMBER IN MEMORY

Your EXA7950 phone has 10 memory locations for storing important telephone numbers.

- 1) Remove the handset from the base.
- 2) Press **mem**. You hear a beep and the **talk/batt** LED blinks.
- 3) Enter the phone number, up to 16 digits. If a pause is needed during dialing to access a long distance or other service, press **pause** to insert a pause.
- 4) Press **mem** again.
- 5) Enter the memory location (0-9) on the keypad. A tone indicates that the number is stored.

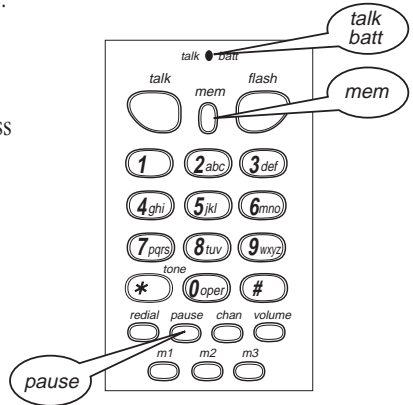

## NOTE

You cannot store numbers in **m1**, **m2** or **m3**. Refer to "One-Touch Dialing."

## DIALING A STORED NUMBER

▼ *Using the memory location features*

- 1) Press **talk**.
- 2) Press **mem**.
- 3) Enter the memory location (0-9) on the keypad. The stored number automatically dials.

## NOTE

If you select a memory location that does not have a stored number, the handset will beep rapidly and the phone will not dial.

### ▼ One-touch priority dialing

Your phone is equipped with three “One-Touch Priority” keys for instant dialing. *You cannot store phone numbers directly into **m1**, **m2** or **m3**.* They are only used to dial phone numbers stored into memory locations 1, 2 and 3. (See “Storing a Phone Number in Memory,” page 13.)

To instantly dial phone numbers stored in memory locations 1, 2 or 3, simply press **m1**, **m2** or **m3**. (There is no need to press talk; the phone will automatically dial.)

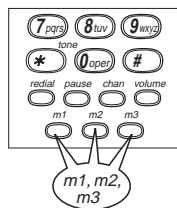

## NOTE

An error sounds and the erase procedure will be canceled if more than 20 seconds elapse between each keystroke.

If you press m1, m2 or m3, and no phone number was stored in memory locations 1, 2, or 3, the phone will beep rapidly but will not dial.

## CHAIN DIALING

On certain occasions after dialing a number, you may be requested to enter an access code, such as your account number. You can enter this number into a memory location for later use by doing the following.

- 1) Store the access code into one of the memory locations (0-9) or memory keys **m1**, **m2**, or **m3** following the steps above.
- 2) Dial the party or service main number.
- 3) When you need to enter the special number, press **mem** followed by the memory location (0-9) or memory keys **m1**, **m2**, or **m3**

## ERASING A STORED NUMBER FROM MEMORY

- 1) Remove the handset from the base unit.
- 2) Press the **mem** button twice.
- 3) Press the memory location (0-9). A tone indicates that the stored number is erased from memory.

## NOTE

*You cannot erase the phone numbers from memory locations 1-3 by pressing the **m1** - **m3** keys. You must use the keypad (1-3) for these locations.*



## NOTE

The tone feature only applies when the base unit is set to pulse.

## TIP

Adjust the speakerphone volume by pressing ▲ for louder or ▼ for softer.

## REDIAL

The **redial** key redials the last number dialed. The redialed number can be up to 32 digits long.

## TONE

If you are dialing in the pulse mode and need to enter tone digits, press **tone** to enter the digits. Once the call has ended, the tone mode is canceled and pulse dialing resumes.

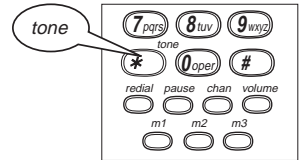

## TRAVELING OUT-OF-RANGE

During a call, as you begin to move your handset too far from your base unit, noise increases. If you pass the range limits of the base unit, your call will terminate within 20 seconds.

## CHANNEL

To help eliminate background noise, press **chan** to change channels.

## USING THE SPEAKERPHONE

To use the speakerphone to answer a call, press **speaker** on the base. Direct your voice to the microphone on the bottom of the base. To hang up, press **speaker** again.

To use the speakerphone while making a call, first dial the number using the handset. Then press **speaker** on the base unit. You can press **talk** to disconnect the handset and continue the call with the speakerphone. Press **speaker** to hang up.

## THREE-WAY CALL

First, dial the number using the handset. Then, press **speaker** to set up a three-way call between the base, handset, and the person on the line.

### THE INTEGRATED ANSWERING DEVICE

The EXA7950 has a built-in answering system that answers and records incoming calls. You can also use your answering system to record a conversation, leave a voice memo message for others who use the phone, or to announce a special message to callers when you're away from your phone.

### FEATURES

- Digital Tapeless Recording
- 15 minutes of Recording Time
- Call Screening
- Selectable Outgoing Messages
- Time and Day Stamp
- Remote Message Retrieval and Room Monitor
- Toll Saver
- Conversation Recording

Digital Tapeless Recording allows you to quickly review, save, or delete the messages you choose. You'll never have to worry about a tape wearing out, jamming, or resetting improperly.

The Integrated Answering System is easy and convenient to use, but ***please read*** through all of the instructions carefully before attempting to use it.

## TIP

Adjust the volume of the system's announcements by pressing ▲ or louder or ▼ for softer on the base speaker.

## NOTE

Press *skip* or *repeat* multiple times to scroll through days, hours, minutes, etc.

## NOTE

If you make no entries within two minutes, the system returns to standby.

## TURNING THE ANSWERING SYSTEM ON/OFF

- 1) To turn the answering system on, press **answer on/off**. A beep tone will sound and the current outgoing message will play on the base speaker. A second beep tone will sound after the outgoing message plays. The message counter LED lights to indicate that the unit is ready to answer calls.

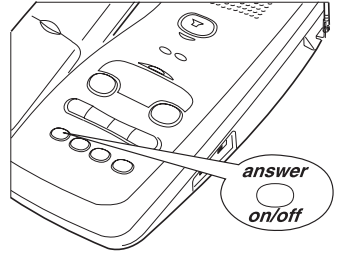

- 2) To turn the answering system off, press **answer on/off** again. A beep tone will sound followed by the announcement "Answer off" and the message counter LED will go out.

## SETTING THE CLOCK

The clock on the EXA7950 Answering System starts when power is applied to the base. Follow these steps to set the clock to the correct time:

- 1) Press and hold **clock** until a beep tone sounds.

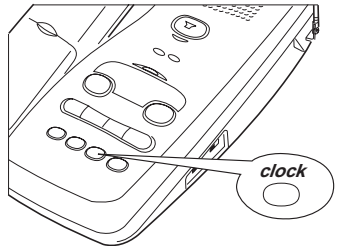

- 2) Next, press the **skip** or **repeat** key until the correct day is announced. (Numbers zero through six display on the base as each day is announced.)

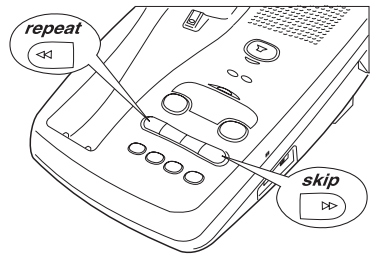

- 3) Press **clock** again to select the day. The hour setting is announced.

- 4) Press **skip** or **repeat** until you hear the current hour setting. Numbers 1 through 12 display on the base as each hour is announced.
- 5) Press **clock** again to select the correct hour.
- 6) Press **skip** or **repeat** until you hear the current minute setting. The numbers 0 through 59 display on the base as each minute is announced.
- 7) Press **clock** again to select the correct minute. The AM/PM setting is announced.
- 8) The LED displays an *A* or *P*. Press **skip** or **repeat** until you hear the correct AM/PM setting.
- 9) Press **clock** again to end the time/day setting. The EXA7950 announces the time that you have set.

### NOTE

You can record up to a 30-second greeting.

## SETTING YOUR OUTGOING MESSAGE (GREETING)

When you receive a call, the answering system automatically plays either a preset message or your own personal outgoing message.

### ▼ *Preset message*

The following message is prerecorded:

*"Hello, no one is available to take your call. Please leave a message after the tone."*

To record your own greeting, follow the steps below.

### ▼ *Recording your personal greeting*

- 1) Press and hold **greeting** until you hear a long tone. Start recording your message immediately after you hear the long tone end. The message counter LED will blink, indicating record mode.

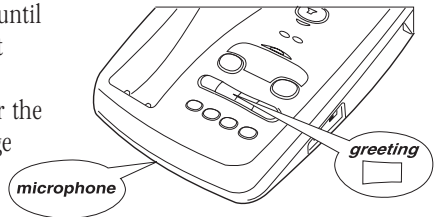

### NOTE

Stand within 12 inches in front of the microphone and speak clearly when recording your outgoing message.

- 2) When you are finished recording your message, press **greeting** again. A tone sounds and your message plays back on the base speaker.

**NOTE**

To choose between the prerecorded outgoing message and your personal outgoing message, press **greeting** during outgoing message playback. This switches between the two options.

▼ *Announce only feature*

The Announce Only feature plays a prerecorded outgoing message or your own personal outgoing message, but it will not allow the caller to leave a message.

Move the **REC TIME** switch to the **ANN** position. The message counter LED displays **R** when the system is on standby.

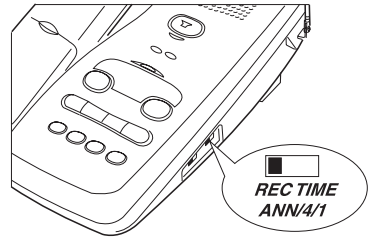

**SELECTING THE MESSAGE RECORD TIME**

You can set your answering system to record messages up to one or four minutes long.

One minute option: move the **REC TIME** switch to **1**.

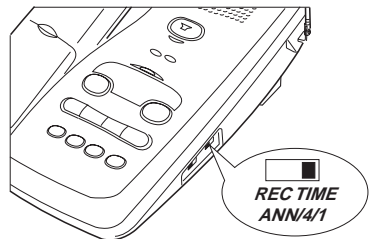

Four minute option: move the **REC TIME** switch to **4**.

## NOTE

If you don't select a PIN code within two minutes, the system returns to standby.

## NOTE

Press **skip** or **repeat** multiple times to scroll through numbers on the display.

## SELECTING A PIN CODE

To play your messages from a remote location, you will need to enter a two-digit Personal Identification Number (PIN) code (00-99). To select a PIN, perform the following steps:

- 1) On the base, press and hold the **pin** button. A beep sounds, and the LED displays **00**.

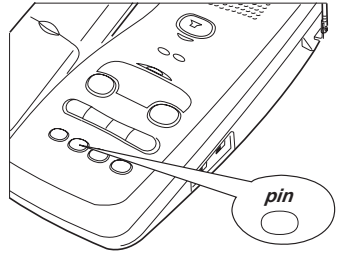

- 2) To set the first number, press **skip** or **repeat** to scroll from **0** to **9**. When the desired number appears in the display, press **pin**. This selects the first number.

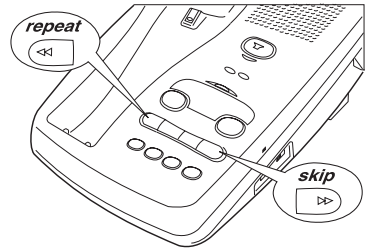

- 3) To set the second number, press **skip** or **repeat** to scroll from **0** to **9**. When the desired number appears in the display, press **pin**. This selects the second number and the entered PIN is announced.

## CALLING PARTY CONTROL FEATURE

The Calling Party Control (CPC) feature automatically sets your answering system to disconnect and reset if the caller hangs up before leaving a message. This prevents your answering system from recording a hang up/dial tone.

## SETTING THE TOLL SAVER SWITCH

The ring time/toll saver switch allows you to set the number of rings the caller hears before your answering system plays your outgoing message.

You can set the switch to answer after **two** rings or after **four** rings. In the **TS** (Toll Saver) position, the answering system picks up after two rings if you have new messages, and after four rings if there are none. This way, if you call long distance to check your messages, you can hang up after the second ring to avoid billing charges.

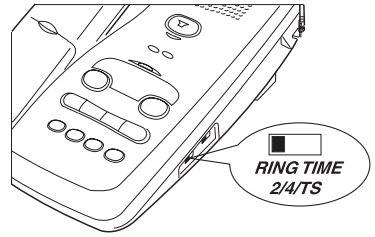

## USING THE RESET BUTTON

The **RESET** button is used to initialize the base computer.

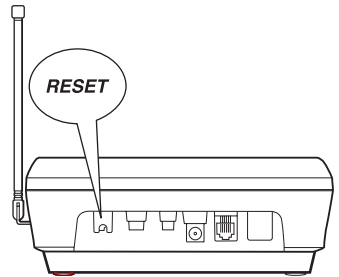

The **RESET** button can be used if an AC power line disturbance causes the answering system to malfunction and become inoperative. Pressing **RESET** does NOT erase any data stored in your system memory.

### HINT

To stop playing your messages at any time, press **play/stop** again.

### PLAYING YOUR MESSAGES

The base LED shows the number of total messages on the display. If the display is blinking, then there are new messages waiting for you. The EXA7950 is designed to play your new messages first. After you play your new messages, you can then play your old messages.

- 1) Press **play/stop**. The system announces the number of new and old messages. The time and day each message was received is announced after the message is played, and the message counter LED displays the number of the current message.

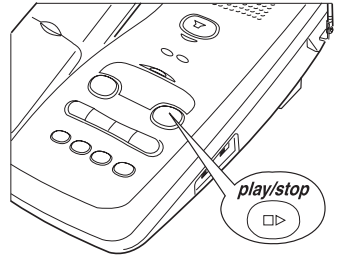

- 2) When all new messages have played, a long tone is heard. The message counter LED stops flashing to indicate that all of the new messages have been reviewed.
- 3) After you have reviewed your new messages, you can play your old messages again. Press **play/stop** and follow the instructions above.

### REPEATING A MESSAGE

- 1) Press **play/stop** to review your messages. The number of stored messages is announced.

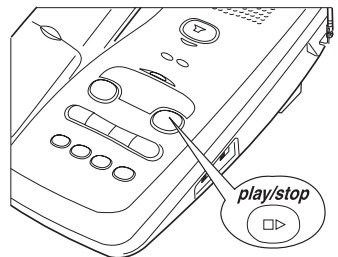



## NOTE

Pressing **repeat** before two and one half seconds of the message has played causes the system to scan back one message.

## TIP

If you have several messages, press **repeat** until you return to the message you want replayed

## HINT

Each time **skip** is pressed, the system scans forward one message. If you have several messages, press **skip** to find the message you want to play.

- 2) After a message has played for a few seconds, press **repeat** to replay the message.

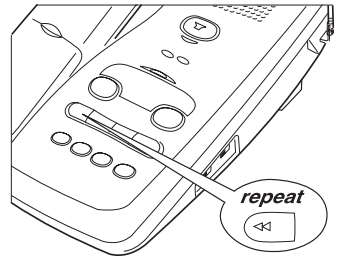

- 3) Press **play/stop** at any time to stop reviewing your messages and return to standby. The message counter LED shows the total number of messages still on the system.

## SKIPPING A MESSAGE

- 1) Press **play/stop** to review your messages. The number of messages is announced.

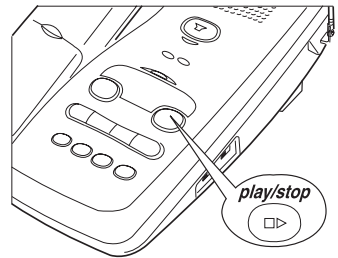

- 2) Press **skip** at anytime to skip to the next message.

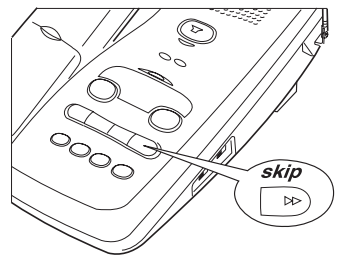

- 3) Press **play/stop** at any time to stop reviewing your messages and return to standby. The message counter LED shows the total number of messages still on the system.

## DELETING A MESSAGE

1. Press **play/stop** to review your messages.

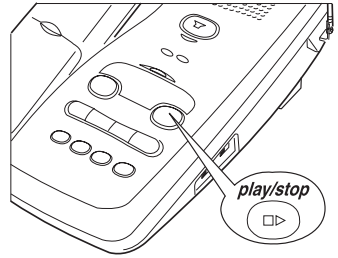

2. If you decide to delete a message, press and hold **delete** anytime during the message. The system beeps and immediately goes to the next message.

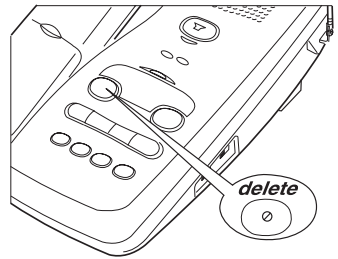

3. After you have played all of your messages, a long tone sounds on the base speaker.

*To delete all messages, press and hold **delete** after reviewing your messages. A tone sounds when all message are cleared.*

## VOICE MEMO

The Voice Memo function allows the user to record a message on the base.

- 1) Press and hold **voice memo**. A beep tone sounds and the message counter LED begins to blink.

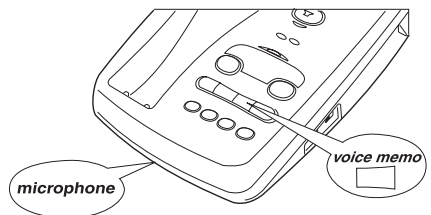

### NOTE

When you press **delete**, you are permanently deleting the message. Once deleted, the message cannot be replayed.

### NOTE

The system automatically returns to standby when all messages have played.

### NOTE

The voice memo function is completely independent of the outgoing message. It's handy for leaving others a quick message.

## NOTE

A voice memo message is treated as a typical recorded message and will be added to the stored messages.

## NOTE

A recorded conversation is treated as a typical message and will be added to the stored messages.

- 2) Release **voice memo** and speak into the microphone.
- 3) When you have finished, press **play/stop** or **voice memo** to stop recording. The system returns to standby.

## RECORDING A CONVERSATION

You can record up to a 15 minute conversation while you are using your phone.

- 1) During a conversation, press **voice memo**. The unit begins recording and two dashes show in the display. A beep that can be heard by both parties sounds every 15 seconds.

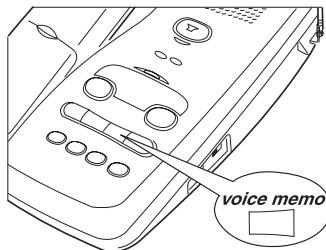

- 2) To stop recording, press **play stop** or **voice memo** again.

## REMOTE ACCESS AWAY FROM HOME

You can operate your answering system from a remote location using any touch-tone telephone. Use this function to check for recorded messages, to play or delete messages, even to record a new outgoing message, and to monitor sounds in the room.

- 1) Call your telephone number.
- 2) During the outgoing message playback, press **#** followed by your PIN code. Refer to page 20 for instructions on how to select a PIN code.
- 3) The answering system announces the time and day stamp followed by the number of messages stored in memory. Message playback automatically begins.



**NOTE**

You must enter a command within 15 seconds of entering command waiting mode or the answering system automatically hangs up and returns to standby.



**NOTE**

The system will only play back messages for four minutes and then it returns to command waiting mode. To continue playing your messages, press **#** then **2** again within 15 seconds.

- 4) You may continue to listen to your messages, or you may select a command from the following chart:

<b>FUNCTION</b>	<b>PRESS</b>
Repeat a Message	<b>#</b> then <b>1</b>
Playing your Messages	<b>#</b> then <b>2</b>
Skipping a Message	<b>#</b> then <b>3</b>
Deleting a Message	<b>#</b> then <b>4</b>
Stop Message Playback	<b>#</b> then <b>5</b>
Answering System On	<b>#</b> then <b>6</b>
Voice Memo Record/Stop	<b>#</b> then <b>7</b>
Greeting Record/Stop	<b>#</b> then <b>8</b>
Answer System Off	<b>#</b> then <b>9</b>
Remote Room Monitor	<b>#</b> then <b>*</b>

- 5) After all of your messages have played, you will hear intermittent beeps indicating that the system is in the command waiting mode. You may enter another command at this time from the chart above.
- 6) When you are finished, hang up to exit the system. The answering system automatically returns to standby.

## REMOTE ROOM MONITOR

You can call your answering system from any touch-tone phone and monitor sounds in the room where your base is installed.

- 1) Call your telephone number.
- 2) During the outgoing message playback, press **#** followed by your PIN code.
- 3) The answering system begins announcing the time and day stamp.
- 4) Press **#** then **\*** while the system announces the time and day stamp.

You hear sounds in the room where your phone is installed. After 15 seconds, the answering system returns to the command waiting mode.

- 5) Press **#** then **\*** to monitor the room for another 15 seconds. Or, select another remote function. Or, hang up to exit the system. The answering system automatically returns to standby.

### QUICK REFERENCE CHART

If your phone is not performing to your expectations, please try these simple steps first.

PROBLEM	SUGGESTION
The charge light won't come on when the handset is placed in the base.	<ul style="list-style-type: none"> <li>• Make sure the AC adapter is plugged into the base and wall outlet.</li> <li>• Make sure the handset is properly seated in base.</li> <li>• Make sure the charging contacts on the handset and base are clean.</li> </ul>
The audio sounds weak and/or scratchy.	<ul style="list-style-type: none"> <li>• Make sure that the base antenna is in a vertical position.</li> <li>• Move the handset and/or base to a different location away from metal objects or appliances and try again.</li> <li>• Press <b>chan</b> to help eliminate background noise.</li> </ul>
Can't make or receive calls.	<ul style="list-style-type: none"> <li>• Check both ends of the base telephone line cord.</li> <li>• Make sure the AC adapter is plugged into the base and wall outlet.</li> <li>• Disconnect the AC adapter for a few minutes, then reconnect it.</li> <li>• Place the handset back on the charging cradle for a few seconds. The <b>status</b> LED will blink indicating that the phone has been reset.</li> </ul>

PROBLEM	SUGGESTION
The handset doesn't ring or receive a page.	<ul style="list-style-type: none"> <li>• The Nickel-Cadmium battery pack may be weak. Charge the battery on the base unit for 15-20 hours.</li> <li>• The handset may be too far away from the base unit.</li> <li>• Place the base unit away from appliances or metal objects.</li> <li>• Place the handset back on the charging cradle for a few seconds. The <b>status</b> LED will blink indicating that the phone has been reset.</li> </ul>
The answering system does not work.	<ul style="list-style-type: none"> <li>• Make sure the base unit is plugged in.</li> <li>• Make sure the answering system is turned on.</li> <li>• Press <b>RESET</b> after an AC line spike.</li> </ul>
The answering system does not answer calls.	<ul style="list-style-type: none"> <li>• Set the <b>REC TIME</b> switch to either the one minute or four minute option.</li> <li>• The memory may be full. Delete some or all of the saved messages.</li> </ul>
Messages are incomplete.	<ul style="list-style-type: none"> <li>• The incoming messages may be too long. Remind callers to leave a brief message.</li> <li>• The memory may be full. Delete some or all of the saved messages.</li> </ul>
After a power failure, the outgoing message is deleted.	<ul style="list-style-type: none"> <li>• Record your personal outgoing message again. The default messages should remain.</li> </ul>
No sound on the base unit speaker during call monitoring or message playback.	<ul style="list-style-type: none"> <li>• Adjust the speaker volume on the base unit.</li> </ul>

<b>PROBLEM</b>	<b>SUGGESTION</b>
Cannot access remote call-in features from another touch-tone phone.	<ul style="list-style-type: none"><li>• Make sure you're using the correct PIN number.</li><li>• Make sure that the touch-tone phone you're using can transmit the tone for at least two seconds. If it cannot, you may have to use another phone to access your messages.</li></ul>



## S P E C I F I C A T I O N S

OF YOUR NEW PHONE

**GENERAL**

The EXA7950 complies with FCC Parts 15 and 68.

Frequency control: PLL

Modulation: Frequency Shift Keying

Operating temperature: 0° to 50° C (+32° F to +122° F)

**BASE**

Transmit Frequency: 925.997 to 927.947 MHz

Receive Frequency: 902.052 to 904.002 (40 channels)

Power requirements: 9V 350 mA (from AC adapter)

Size: 7-3/8 in.(W) x 2 in. (D) x 8-3/4 in. (H)

Weight: Approx. 21.1 oz. (including optional battery)

**HANDSET**

Transmit Frequency: 902.052 to 904.002 MHz

Receive Frequency: 925.997 to 927.947 (40 channels)

Power requirements: Rechargeable Nickel-Cadmium battery pack

Size (without antenna): 2.28 in. (W) x 1.73 in. (D) x 7.09 in. (H)

Weight: Approx. 8.9 oz. (including battery)

Battery: BT-905

Capacity 600 mAh, 3.6V

Talk mode 7 hours

Standby mode 14 days

*Specifications, features, and availability of optional accessories are all subject to change without prior notice.*

## **At Uniden, we'll take care of you!**

If you need any assistance with this product, please call our Customer Hotline at:

# **1-800-297-1023**

Please do not return this product to the place of purchase

Our Uniden representatives will be happy to help you with any matters regarding the operation of this unit, available accessories, or any other related matters.

*Hours: M-F, 7:00 AM to 7:00 PM CST*

*Thank you for purchasing a Uniden product.*

# CONTROLS

## AND FUNCTIONS

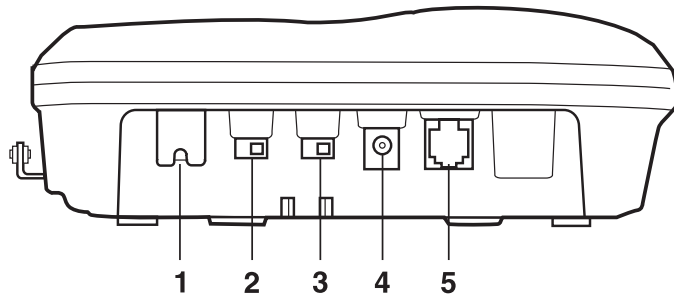

- |                       |                             |                     |                  |
|-----------------------|-----------------------------|---------------------|------------------|
| 1. Reset              | 10. Flash                   | 22. Delete          | 35. Play/Stop    |
| 2. Base Ringer Off-On | 11. Memory                  | 23. Repeat          | 36. Voice Memo   |
| 3. Pulse/Tone         | 12. Numeric Keypad          | 24. Answer On/Off   | 37. Skip         |
| 4. DC In 9V Jack      | 13. Tone                    | 25. Microphone      | 38. Greeting     |
| 5. Tel Line Jack      | 14. Redial                  | 26. Set PIN         | 39. Base Antenna |
| 6. Handset Antenna    | 15. Pause                   | 27. Set Clock       | 40. Record Time  |
| 7. Handset Earpiece   | 16. Handset Ringer          | 28. Page            | 41. Ring Time    |
| 8. Talk/Batt Low LED  | 17. Channel                 | 29. Base Speaker    |                  |
| 9. Talk               | 18. One-Touch Priority Keys | 30. Speaker Button  |                  |
|                       | 19. Handset Microphone      | 31. Speaker LED     |                  |
|                       | 20. Handset Retainer Clip   | 32. Speaker Volume  |                  |
|                       | 21. Charging Contacts       | 33. Status LED      |                  |
|                       |                             | 34. Message Counter |                  |

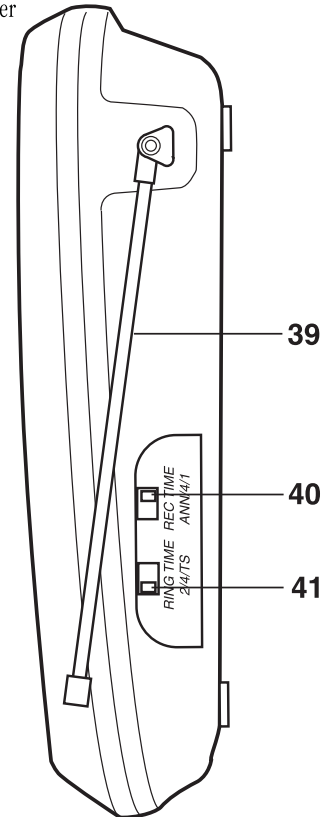
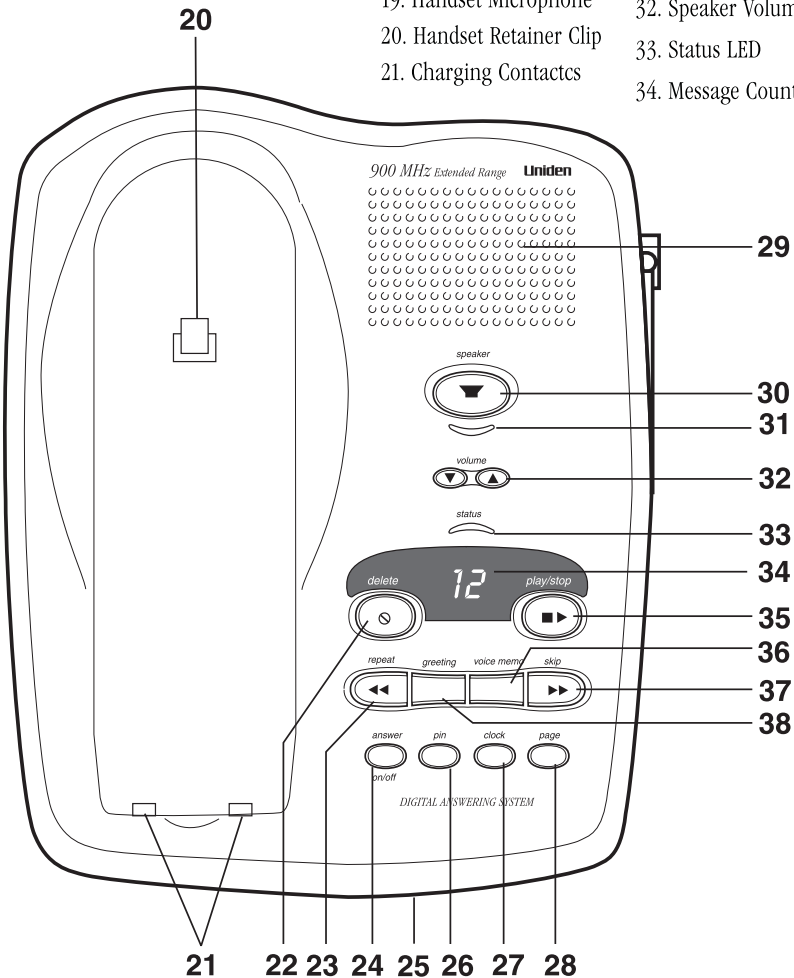
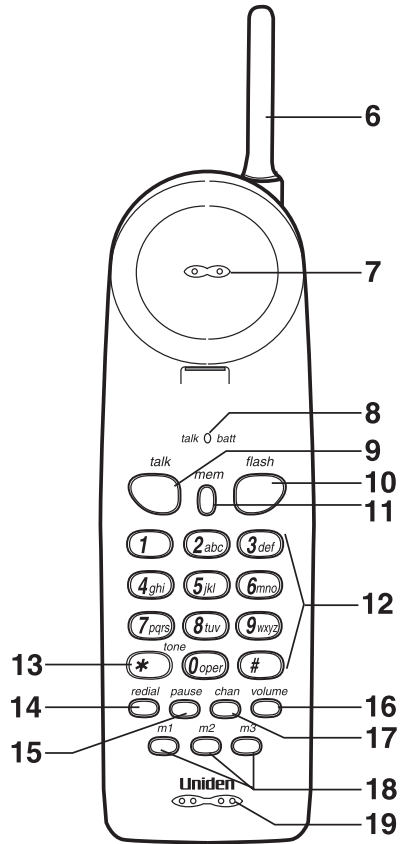

# THANK YOU

FOR PURCHASING A UNIDEN PHONE!

## Uniden®

Covered under one or more of the following U.S. patents:

4,511,761 4,523,058 4,595,795 4,797,916 5,381,460 5,426,690  
5,434,905 5,491,745 5,533,010 5,574,727 5,650,790 5,660,269  
5,661,780 5,663,981 5,671,248 5,717,312 5,754,407 5,768,345  
5,787,356 5,838,721

© June 1999 Uniden America Corporation

All rights reserved • Printed in China

UCZZ01243ZZ

## Free Manuals Download Website

<http://myh66.com>

<http://usermanuals.us>

<http://www.somanuals.com>

<http://www.4manuals.cc>

<http://www.manual-lib.com>

<http://www.404manual.com>

<http://www.luxmanual.com>

<http://aubethermostatmanual.com>

Golf course search by state

<http://golfingnear.com>

Email search by domain

<http://emailbydomain.com>

Auto manuals search

<http://auto.somanuals.com>

TV manuals search

<http://tv.somanuals.com>