



EXAI 985HS

OWNER'S MANUAL

900 MHz Cordless
Phone with Digital
Answering System

Caller ID and
Call Waiting
Operation

3-Way Conference
Operation

Uniden®

Introduction

Thank you for choosing the Uniden EXAI 985HS cordless telephone. This phone is designed to exacting standards that provide reliability, long life and outstanding performance.

Note: Some illustrations in this manual may differ from the actual unit for explanation purposes.

Features

- 900 MHz Extended Range
- Secure Digital Transmission
- Answering Device
- Caller ID and Call Waiting Caller ID
- Advanced Caller ID with Call Waiting Option
- 50 Number Caller ID Memory
- 30 Number Memory (20 on the handset, 10 on the base)
- 32 Digit Redial
- 3-Line, 16 Character Backlit LCD Handset Display
- Redial, Flash and Pause
- Pulse / Tone Dialing
- 7 Hour Talk Time
- 7 Day Standby Battery Life
- Handset Earpiece and Ringer Volume Control
- Speakerphone
- 3-Way Conference
- Headset Included for Hands-free Communication

Uniden® is a registered trademark of Uniden America Corporation

Controls and functions

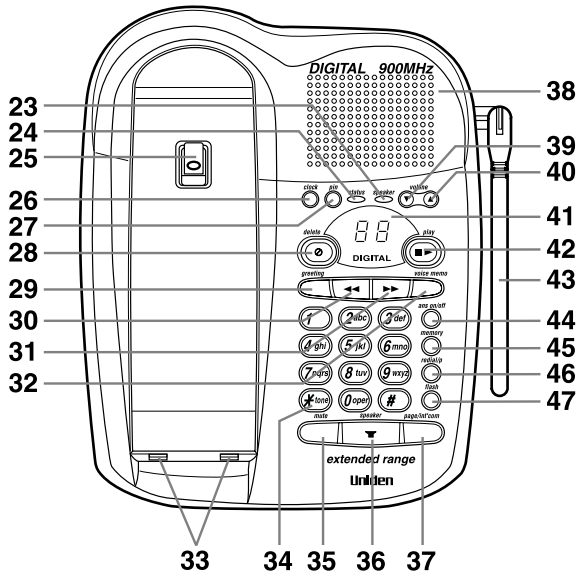
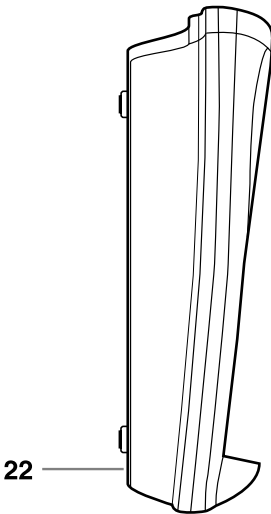
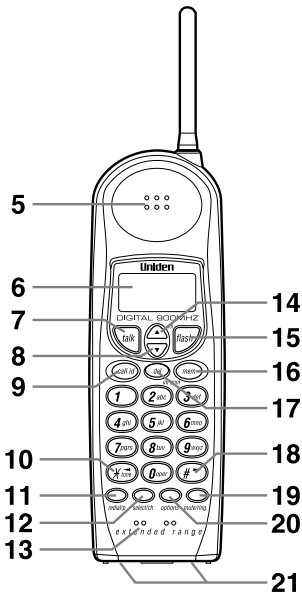
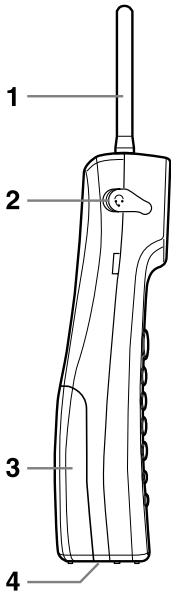

1. Handset antenna
2. Headset jack cover
3. Handset battery compartment
4. Handset ringer switch
5. Handset earpiece
6. LCD display
7. Talk key
8. Volume/Cursor down/
character select key
9. Caller ID key
10. Tone/Backspace key
11. Redial/Pause key
12. Select/Channel key
13. Handset microphone
14. Volume/Cursor up/
character select key
15. Flash key
16. Memory key
17. Delete/Intercom key
18. Cursor forward key
19. Mute/Ring key
20. Options key
21. Handset contact
22. Base microphone
23. Speaker LED
24. Status LED
25. Handset retainer clip
26. Clock key
27. Pin code key
28. Delete key
29. Greeting key
30. Repeat key
31. Skip key
32. Voice memo key
33. Base contact
34. Tone key
35. Mute key
36. Speaker key
37. Page/Intercom key
38. Base speaker
39. Volume down key
40. Volume up key
41. LED display
42. Play/Stop key
43. Base antenna
44. Answer on/off key
45. Memory key
46. Redial/Pause key
47. Flash key
48. Record time switch
49. Ring time switch
50. Base ringer switch
51. Pulse-Tone switch
52. DC power input
53. Phone jack

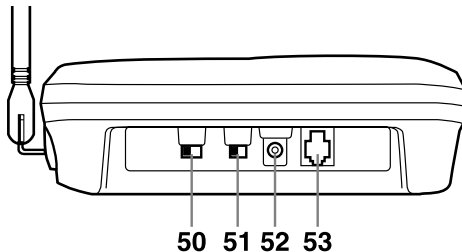
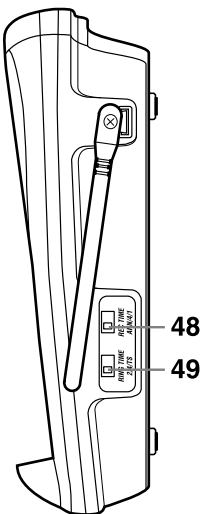

Contents

Introduction / Features.....inside front cover
 Controls and Functionsinside front cover

Getting Started
 Read this first.....4
 Step 1: Checking the package contents5
 Step 2: Setting up the base unit6
 Mounting the base unit on a wall9
 Step 3: Preparing the battery pack.....11
 Step 4: Setting the Caller ID options.....13
 Entering your area code14

Basics
 Making a call15
 Receiving a call16
 Mute17
 Adjusting the ringer and earpiece volume18
 Redialing a call19
 Traveling out-of-range.....20
 Using your EXAI 985HS intercom.....21
 Transferring a call.....22

Memory Dialing
 Storing phone numbers and names.....23
 Making calls with memory dialing.....26
 Editing a stored name and/or phone number...28
 Erasing a stored name and phone number.....30

3-way Conference Feature
 3-way conferencing.....32

Caller ID Features
 Caller ID service.....33
 When the telephone rings34
 Viewing the Caller ID Message list.....35
 Deleting information from Caller ID list.....36
 Using the Caller ID list38
 Using "Caller ID with call waiting" service40
 Call waiting features41

The Integrated Answering Device
 Features.....42
 Setting up your answering system43
 Using your answering system47

Additional Information
 Changing the digital security code.....53
 Installing the beltclip.....54
 Headset installation55
 Note on power sources56
 Maintenance.....56

General information57

Troubleshooting.....58

Index60

Getting Started

Basics

Memory Dialing

3-way Conference Features

Caller ID Features

Integrated Answering Device

Additional Information

Read this first

This cordless telephone must be set up before use. Follow these steps;

Step 1 (page 5)

Unpack the telephone and accessories.

Step 2 (page 6 to 10)

Next, choose the best location to set up the base unit.



Base unit

Step 3 (page 11 to 12)

Then, insert the battery pack into the handset. You have to charge the battery pack for 12-15 hours before plugging the phone into the phone line.



Handset

Step 4 (page 13 to 14)

Finally, set Caller ID options and store your area code in the memory to use the Caller ID service.



Note: Skip the setting of area code if your calling area requires 10 digit dialing.

Handset

About the digital security code

This cordless telephone uses a digital security code to prevent unauthorized access to your base unit. This security code prevents other cordless handsets from making calls through your base unit. A random security code will be assigned automatically between your base unit and handset when you charge the battery pack for the first time.

If you want to reset the security code, see page 53.

Checking the package contents

Make sure you have received the following items in the package. If any of these items are missing or damaged, contact the **Uniden Parts Department** (see below).



• **Base unit**



• **Handset**

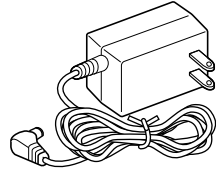

• **AC adapter (AD-420)**

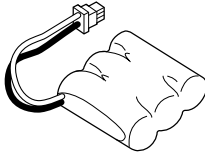

• **Rechargeable battery pack (BT-905)**

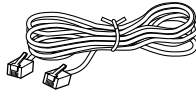

• **Telephone line cord**

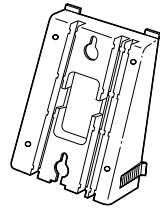

• **Wall mount adapter**

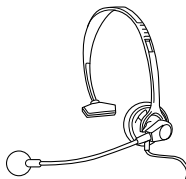

• **Headset**

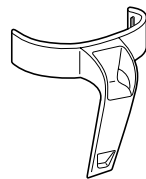

• **Beltclip**

- **This Owner's Manual**
- **Quick Reference Guide**
- **Precautions and Important Safety Instructions**
- **Registration Card**

Uniden Parts Department

(800) 554-3988

Hours: M-F 7:00 AM to 5:00 PM CST.

We can also be reached on the web at www.uniden.com.

Setting up the base unit

Do the following steps.

- Choose the best location
- Connect the base unit
- Choose the dialing mode

Choose the best location

Before choosing a location for your new phone, read the **INSTALLATION CONSIDERATIONS** included in the **PRECAUTIONS AND IMPORTANT SAFETY INSTRUCTIONS** brochure. Here are some important guidelines you should consider:

Avoid heat sources, such as radiators, air ducts, and sunlight

Avoid noise sources such as a window by a street with heavy traffic

Avoid television sets and other electronic equipment

Avoid microwave ovens

Avoid excessive moisture, extremely low temperatures, dust, mechanical vibration, or shock

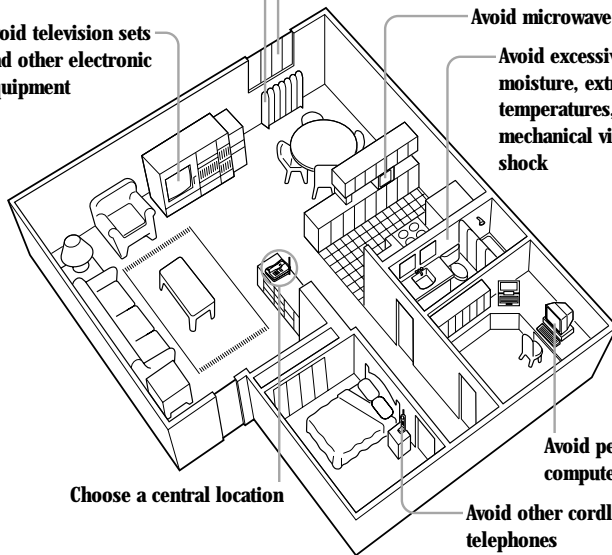

Choose a central location

Avoid personal computers

Avoid other cordless telephones

- After installing the battery pack in the handset, charge your handset for 12-15 hours before plugging the phone into the phone line. Once the handset battery pack is fully charged, then connect the telephone line cord to the base and telephone wall outlet.
- The location should be close to both a phone jack and a continuous power outlet which is not switchable.
- Keep the base and handset away from sources of electrical noise such as motors, microwave ovens, and fluorescent lighting.
- Be sure there is sufficient space to raise the base antenna fully vertical.
- The base can be placed on a desk, tabletop, or mounted on a standard wall plate.

Connect the base unit

If you want to install the base unit on the wall, see page 9.

NOTE

Place the power cord so it does not create a trip hazard, or where it could become chafed and create a fire or electrical hazard.

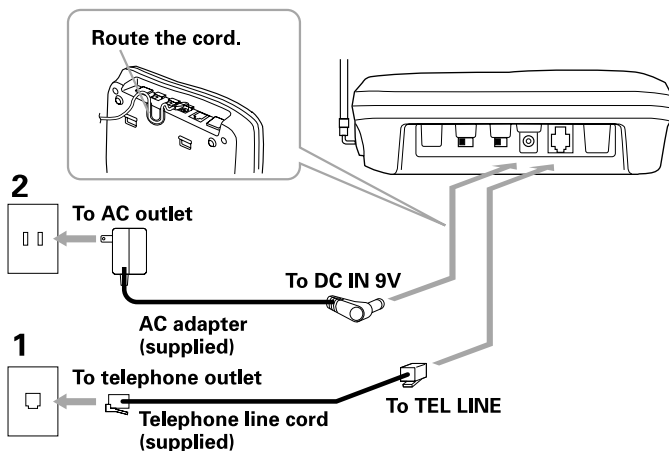

- 1 Connect the telephone line cord to the **TEL LINE** jack and to a telephone outlet.
- 2 Connect the AC adapter to the **DC IN 9V** jack and to a standard 120V AC wall outlet.
- 3 Set the base unit on a desk or tabletop and place the handset on the base unit. Then raise the antenna to a vertical position.

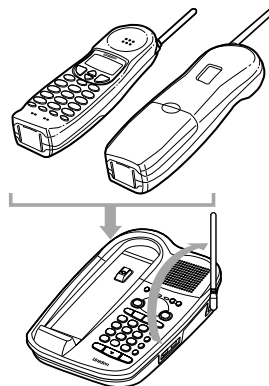



Use only the supplied AD-420 AC adapter. Do not use any other AC adapter.

Polarity of the plug

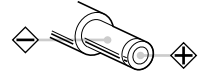

Connect the AC adapter to a continuous power supply.



Place the base unit close to the AC outlet so that you can unplug the AC adapter easily.



If your telephone outlet isn't modular, contact your telephone company for assistance.

Modular



Choose the dialing mode

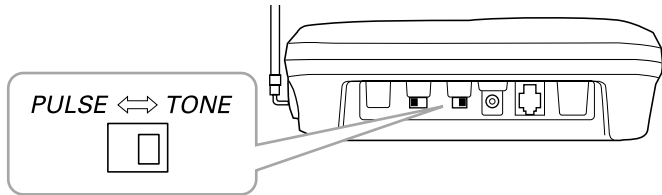

Depending on your dialing system, set the **TONE/PULSE** switch as follows:

If your dialing system is	Set the switch to
Tone	<i>TONE</i>
Pulse	<i>PULSE</i>

If you aren't sure of your dialing system

Make a trial call with the **TONE/PULSE** switch set to ***TONE***.

If the call connects, leave the switch as is; otherwise, set to ***PULSE***.

Mounting the base unit on a wall

Standard wall plate mounting

This phone can be mounted on any standard telephone wall plate.

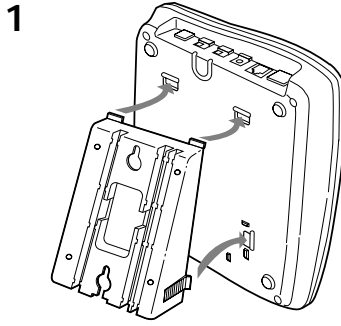

1 Snap the wall mount adapter into the notches on the base.

2 Plug the telephone line cord to the **TEL LINE** jack and the AC adapter to the **DC IN 9V** jack.

3 Plug the telephone line cord into the telephone outlet.

2 - 7

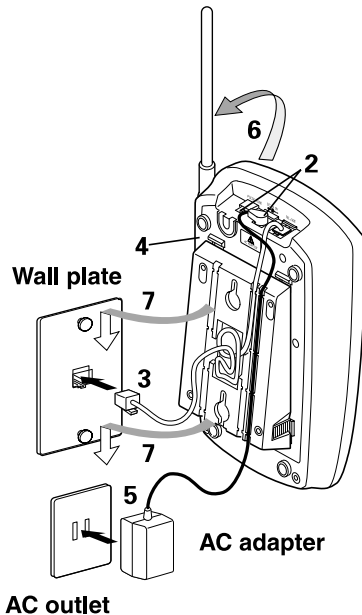

4 Place the AC adapter cord inside the molded wiring channel.

5 Plug the AC adapter into a standard 120V AC wall outlet.

6 Raise the antenna to a vertical position.

7 Align the mounting slots on the base with the mounting posts on the wall. Push in and down until the phone is firmly seated.

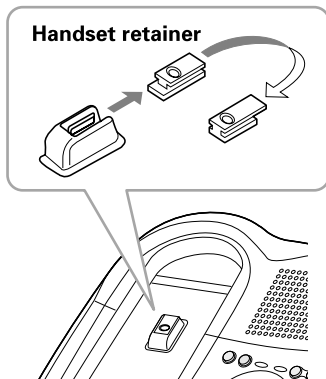

8 On the base unit, pull the handset retainer out of the slot. Rotate it clockwise 180 degrees.

9 Flip the retainer from front to back. Slide it back into the slot so that the lip of the retainer is up and the oval is down. The retainer holds the handset in place.

Direct wall plate mounting

If you don't have a standard wall plate, you can mount your phone directly to the wall. Before doing this, consider the following:

- Avoid electrical cables, pipes, or other items behind the mounting location, that could cause a hazard when inserting screws into the wall.
- Try to mount your phone within 10 - 15 feet of a working phone jack to avoid excessive cord lengths.
- Make sure the wall material is capable of supporting the weight of the base and handset.
- Use #10 screws (minimum length of 1-3/8 inches) with anchoring devices suitable for the wall material where the base unit will be placed.

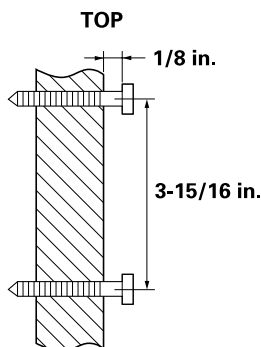

1 Insert two mounting screws into the wall, (with their appropriate anchoring device), 3-15/16 inches apart. Allow about 1/8 of an inch between the wall and screwheads for mounting the phone.

2 Refer to steps 1 through 9 on page 9 and 10 to mount the telephone.

Preparing the battery pack

Charge the battery pack for 12-15 hours before you plug the phone into the phone line.

NOTE

Use only Uniden Battery BT-905. Replacement batteries are also available through the Uniden Parts Department. (See page 5)

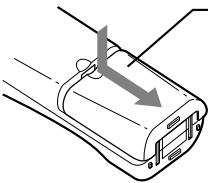
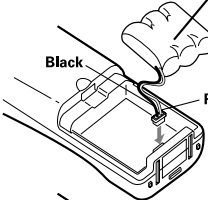
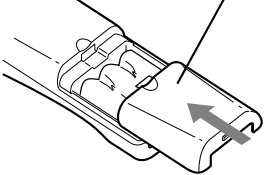
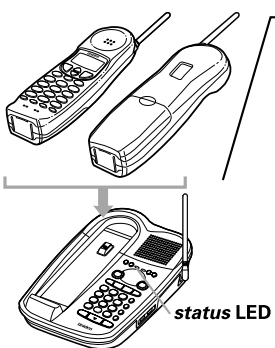
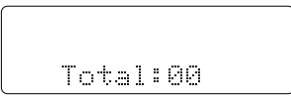
-  1 Remove the battery cover.
-  2 Connect the battery pack connector with the correct polarity (black and red wires), then insert the battery pack into the battery compartment.
-  3 Slide the battery cover forward until it snaps into place.
-  4 Place the handset on the base with the keys and display facing upward. This position lets you see the Caller ID messages on the display.

Make sure that the " *status* " LED of the base unit is lit, and charging begins. Charge the battery for 12-15 hours. You can place the handset either side up for charging the battery.



NOTE

Even when the battery pack is not being used, it will gradually discharge over a long period of time. For optimum performance, be sure to return the handset to the base unit after a telephone call.



NOTE

The redial memory numbers are retained for up to two minutes while you replace the batteries.



NOTE

If you must replace the battery pack during a telephone call, complete the replacement within 30 seconds, and you can return to the original call. (If the replacement battery pack is not fully charged, the call may disconnect.)

Battery use time (per charge)

From fully charged

- Seven hours continuous use.
- Seven days when the handset is in the standby mode.

When the battery charge becomes low

When the battery pack is very low and needs to be charged, the phone is programmed to eliminate functions in order to save power. If the phone is not in use, "Low Battery" flashes and none of the keys will operate. If the phone is in use, "Low Battery" flashes and the handset beeps.

Complete your conversation as quickly as possible and return the handset to the base unit for charging.



Low Battery

Cleaning the battery contacts

To maintain a good charge, it is important to clean the battery contacts on the handset and base unit about once a month. Use a dry cloth or pencil eraser, if necessary.

Do not use any liquids or solvents.

Setting the Caller ID options

There are three Caller ID setup options available; they are AutoTalk, CIDCW (Caller ID on Call Waiting), and Area Code.

Auto Talk allows you to answer the phone without pressing the **(talk)** button. If the phone rings when AutoTalk is on, simply remove the handset from the base and the phone automatically answers the call. If the phone rings when AutoTalk is off, you must press **(talk)** to answer the call.

Caller ID on Call Waiting (CIDCW) performs the same as regular Caller ID on a call waiting number. Call Waiting options allow you to handle call waiting calls in seven different ways. (See page 41.)

You must subscribe to CIDW and CIDCW options from your phone company in order to use this feature.

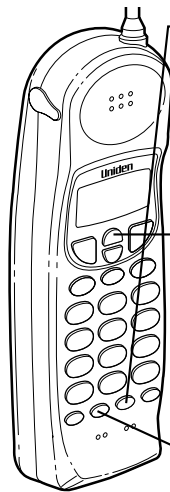

- 1** In the standby mode, press **(options)**. The Caller ID setting screen appears.

```
1 Auto Talk:Off
2 CIDCW      :On
3 Area Code:
```

- 2** Press **(▲)** or **(▼)** to move the pointer to the item that is to be set.

Example: To select CIDCW

```
1 Auto Talk:Off
2 CIDCW      :On
3 Area Code:
```

- 3** Press **(select/ch)** to toggle between On and Off for Auto Talk. For CIDCW, choose On, Off or Opt depending on the type of service to which you subscribe.

- 4** To complete the settings, press **(options)**, then the handset returns to standby mode.

Entering your area code

If you enter a 3-digit area code number in the Area Code option, your local area code does not appear in Caller ID messages. When reviewing Caller ID messages, you will see only the local seven digit number. For calls received from outside your local area code, you will see a full 10-digit number.



If your calling area requires 10-digit dialing, do not program this option.



- 1** When the phone is in the standby mode, press **(options)**. The Caller ID setting screen appears.

```
1▶Auto Talk:Off
2 CIDCW      :On
3 Area Code:
```

- 2** Press **(3)** to select "Area Code".

```
1 Auto Talk:Off
2 CIDCW      :On
3▶Area Code:
```

- 3** Press **(select/ch)**.

```
1 Auto Talk:Off
2 CIDCW      :On
3 Area Code:█
```

- 4** Use the number keypad (**(0)** to **(9)**) to enter the 3-digit area code.

- 5** Press **(select/ch)**.

A beep sounds and the displayed area code is entered.

- 6** Press **(options)** to complete the setting. Or return the handset to the base unit to complete the setting mode and set the handset to the standby mode.



When the area code has already been stored in memory, the stored area code will be displayed. To

change it, use the **(del/int'com)** and number keypad to enter the new area code. Then press **(select/ch)**.

```
1 Auto Talk:Off
2 CIDCW      :On
3 Area Code:81█
```

To complete the setting, press **(options)** or return the handset to the base unit.

Making a call

From the handset

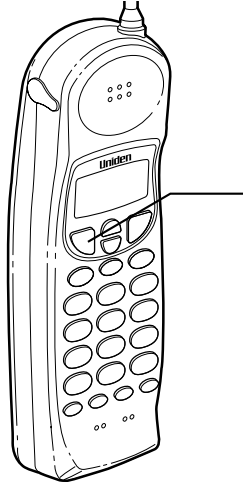

Dialing from standby

- 1 Pick up the handset.
- 2 Dial the phone number.
- 3 Press **(talk)**.
- 4 To hang up, press **(talk)** or return the handset to the base.

Dialing from talk mode

- 1 Pick up the handset and press **(talk)**.
- 2 Dial the phone number.
- 3 To hang up, press **(talk)** or return the handset to the base.

NOTE

The base microphone is located under the phone. Position yourself as near to the base as possible and speak clearly.

From the base

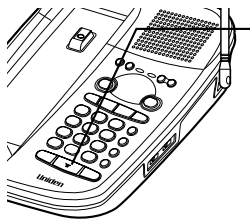

- 1 Press **(speaker)**.
- 2 Dial the number on the keypad.
- 3 To finish the call, press **(speaker)** to hang up.

Other Operations

To	Do this
To improve reception	Press (select/ch) during the conversation. "Scanning" appears on the display. If the operation fails, the error tone sounds.
To adjust the earpiece volume	Press (▲) or (▼) during the call.
To temporarily switch to tone dial (When the base is set to pulse mode)	Press (* / tone / ◀) . The following numbers dialed will be sent as tone dialing.
To enter a pause within the dialing sequence.	Press (redial/p) . "F" appears in the display which represents a pause.

Receiving a call

From the handset

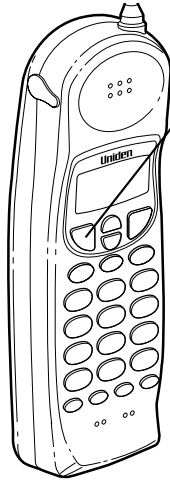

- 1 The phone rings. "Incoming Call" appears on the display.
- 2 Press **talk** if not in Auto Talk mode. Press any key (except **mute**) if in Auto Talk mode. "Talk" appears on the display. Then the earpiece volume is displayed for 2 seconds.
- 3 The call-time display starts when you begin to talk.
- 4 Press **talk** or place the handset on the base to hang up. The call time will be displayed for about 5 seconds.

NOTE

If either the handset or the base does not ring, check each ringer switch to make sure they are set to "on".

From the base

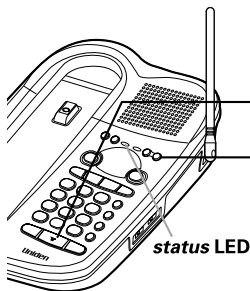

- 1 The phone rings. The **status** LED on the base flashes.
- 2 Press **speaker**.
- 3 Adjust the volume by pressing volume **▲** **▼** as necessary.
- 4 To hang up, press **speaker**.

NOTE

If audio on the speaker phone is not loud enough, adjust the speaker volume on the base.

Mute

You can turn off the base or the handset microphone so that the person you are talking with cannot hear you.

When speaking with the base

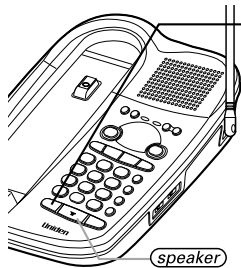

- 1 Press **(mute)** during a telephone call. The microphone is turned off.
- 2 To cancel mute, press **(mute)**, or **(speaker)**.

When speaking with the handset

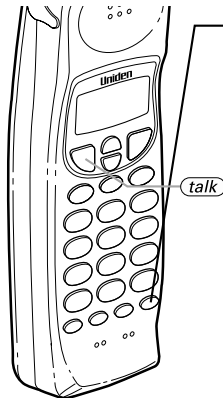

- 1 Press **(mute/ring)** during a telephone call.



The microphone is turned off.

- 2 To cancel mute, press **(mute/ring)** or **(talk)**.

When the phone is ringing

You can temporarily mute the handset's ringer by pressing **(mute/ring)** when the phone rings.

You may still press **(talk)** to answer the call.

Adjusting the ringer and earpiece volume

Handset ringer tone

In the standby mode, press **(mute/ring)**.

Each time **(mute/ring)** is pressed, the ringer tone setting changes and the selected ringer tone sounds for 2 seconds.

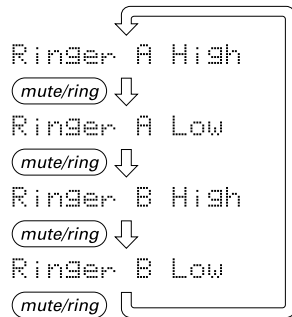

Handset ringer switch

This switch turns the handset ringer on or off.

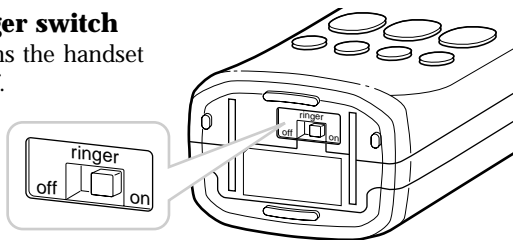

Handset earpiece volume

Pressing **(▲)** or **(▼)** during a telephone call will change the earpiece volume of the handset. This setting will remain in effect after the telephone call has ended.



When you press **(▲)** in Loud mode or press **(▼)** in Low mode, an error tone sounds.

Base ringer switch

This switch turns the base ringer on or off.

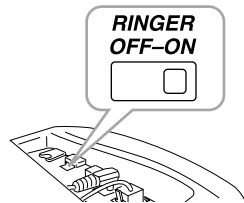

Base speaker volume

To control the speaker volume of the base, adjust the **(volume ▲)** and **(volume ▼)** button as desired.

The volume setting from 1 (lowest) to 10 (highest) appears in the message counter LED.

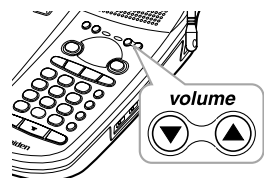

Redialing a call

From the handset

The last three phone numbers entered can be quickly redialed.

NOTE

If the recently dialed number exceeds 32 digits, only the first 32 digits are retained for redialing.

NOTE

Press and hold **del/int'com** to delete the displayed redial number.

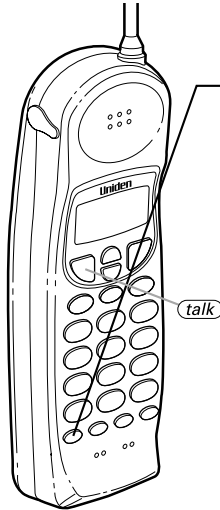

Redialing from Standby

- 1 Press **redial/p**.
The phone number that was last dialed appears on the display.
- 2 Press **redial/p** again.
Each press of **redial/p** will display one of the last three numbers dialed.

Most recent

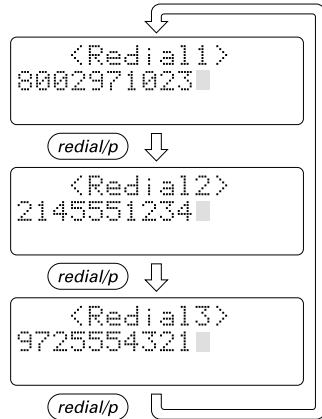

- 3 Press **talk**. The number will be dialed.

NOTE

Only the last number dialed can be accessed after **talk** has been pressed.

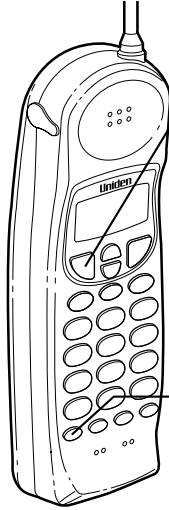

Redialing from talk mode

- 1 Press **talk**.
"Talk" appears flashing on the display.



- 2 Press **redial/p**.
The last number dialed will be displayed, and redialed.

- 3 To hang up, press **talk** or place the handset on the base. The call-time will be displayed for about 5 seconds.

From the base

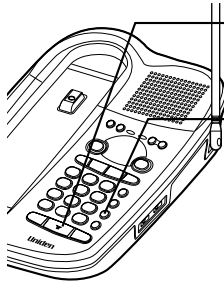

- 1 To call the last number dialed from the base, press **speaker**.
- 2 Press **redial/p**.
- 3 Press **speaker** to finish the call.

Traveling out-of-range

During a call, as you begin to move your handset too far from your base unit, noise increases. If you pass the range limit of the base unit, your call will terminate within 30 seconds.

Using your EXAI 985HS intercom

Intercom from the base to handset

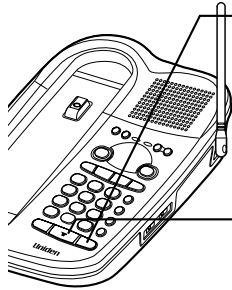

- 1 Press **(page/int'com)** on the base. The handset beeps.
- 2 Press **(del/int'com)** or **(talk)** on the handset. Speak into the handset microphone to answer the base.
- 3 To turn off the intercom, press **(talk)** on the handset or **(speaker)** on the base.

Intercom from the handset to base

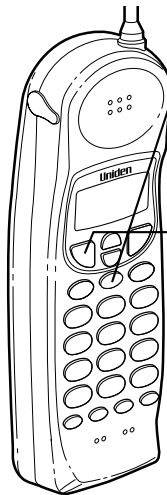

- 1 Press **(del/int'com)** on the handset. The base beeps.
- 2 At the base, press **(page/int'com)** or **(speaker)**. Speak into the base microphone to answer the page.
- 3 To turn off the intercom, press **(talk)** on the handset or **(speaker)** on the base.

Transferring a call

To transfer from the handset to the base

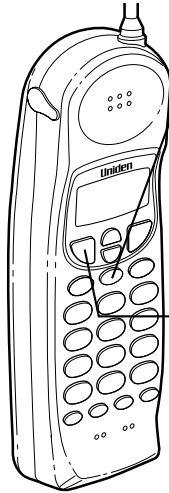

- 1 Press **del/int'com** on the handset while speaking on the handset. The caller is put on hold and the intercom tone sounds on the base.
- 2 Press **page/int'com** or **speaker** on the base. The intercom mode is activated, but the caller is still on hold.
- 3 To transfer the call to the base, press **talk** on the handset. To cancel the transfer, press **speaker** on the base.

To transfer from the base to the handset

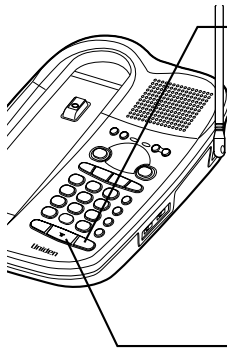

- 1 Press **page/int'com** on the base while speaking on the speaker phone. The caller is put on hold, and the intercom tone will be sounded on the handset.
- 2 Press **del/int'com** or **talk** on the handset. The intercom mode is activated, but the caller is still on hold.
- 3 To transfer the call to the handset, press **speaker** on the base. To cancel the transfer, press **talk** on the handset.

Storing phone numbers and names

Your EXAI 985HS stores up to 20 names and numbers in the handset plus 10 numbers in the base.

On the handset

NOTE

You must press a key within 20 seconds or the phone will return to standby. If you return the handset in the base the phone will return to standby too. Press **mem** and you can go to memory menu at any time.

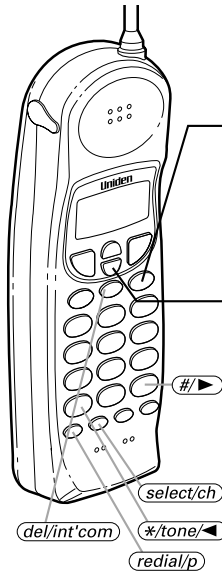

Example: To store a name (MOM AND DAD) and number (8175553300) in memory location 03.

- 1** Press and hold **mem** until "Memory Store" is displayed.

```
Memory Store
01▶ UNIDEN CORP
02 JOHN DOE
```

- 2** Press **▲** and **▼** or enter a two-digit number (01-20) to select the memory location where you would like to store the number.

```
Memory Store
02▶ JOHN DOE
03
```

- 3** Press **select/ch**.
The following screen appears and a cursor flashes indicating that the display is ready for the name to be entered.









```
Store Name
```

If this screen appears, the selected memory location is already stored. Then you must either change the entry in this location, clear the location, or select "Go Back" to choose another location.

```
▶ Edit Memory03
Delete Memory03
Go Back
```

MEMORY

DIALING

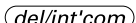
- 4** Use the , , , , or  keys to enter the name. The name cannot exceed 13 characters.
- Use the  and  key to scroll through the character menu. It contains upper and lower case letters and various characters.
 - Use the  and  keys to move the cursor to the desired location.
 - Use the  key to delete characters as needed.

- 5** Press . "Store Number" is displayed. The cursor flashes indicating that the display is ready for the number to be entered.

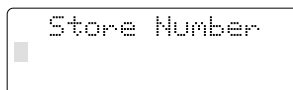

- 6** Use the number keypad to enter the phone number. The phone number cannot exceed 20 digits.

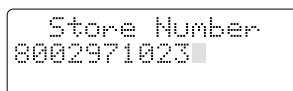

- Use the  key to enter pause in the dialing sequence. The display shows a "P". Each pause counts as one digit and represents a two second delay in time between digits.

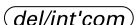

The pause feature is useful for long distance calling, credit card dialing, or sequences that require a pause between digits.

- Use the  key to delete digits as needed.

- 7** Press . The handset beeps and displays the confirmation screen. Memory storage is complete.

For example, if you store a name and number into memory location number 03, the display shows "Memory03 Stored".

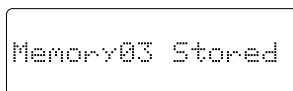

After about 2 seconds, "Memory Store" is displayed.

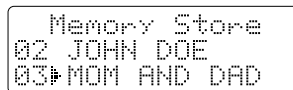

- 8** Press  to return to standby mode.

On the base



You can store only numbers in the base.

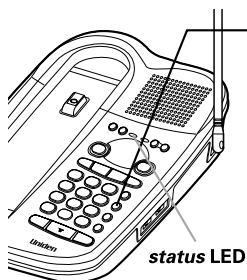

- 1** Press *memory* .
The status LED blinks.
- 2** Dial the number you wish to store.
- 3** Press *memory* .
Enter the memory location number (0-9) on the keypad.
A confirmation tone indicates the number is stored.

Making calls with memory dialing

From the handset

NOTE

You must press key within 20 seconds or the phone will return to standby. You may also press **(mem)** to access a memory menu at any time.

NOTE

If you press **(select/ch)** before **(talk)**, you can confirm the name and number stored in the selected memory location. To exit this mode, press and hold **(del/int'com)**. The handset returns to standby.

NOTE

To exit the memory function without dialing, press **(mem)**. The handset returns to standby.

Dialing from standby

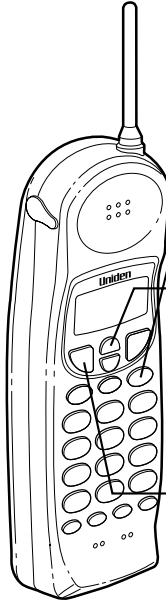

- 1** Press **(mem)**.
The handset displays your programmed memory locations.

```
01 UNIDEN CORP
02 JOHN DOE
03 MOM AND DAD
```

- 2** Press **(▲)** and **(▼)** or enter a two-digit number (01-20) to select the memory location you would like to dial.

- 3** Press **(talk)**. "Talk" flashes and the volume setting appears on the display. Then the displayed number is dialed.

```
-Talk-
0123456789012
```

Display a Programmed Number

Use the **#/▶** and ***/tone/◀** keys to toggle between the names display and the numbers display.

Program name	Program number
01 UNIDEN CORP	01 8002971023
02 JOHN DOE	02 5452930
03▶MOM AND DAD	03▶8175551212



When the stored phone number has 14 or more digits, “▶” is displayed next to the 12th digit. Press **#/▶** to see the extra digits and ***/tone/◀** to return.

```
15 0123456789012
16▶011813554329+
17
```



If you select a memory location that does not have a stored number, the handset will beep rapidly and the phone will not dial.

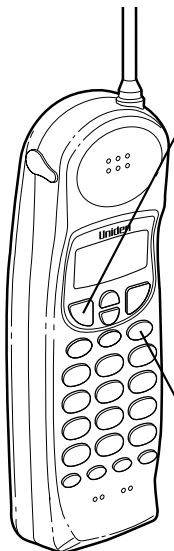

Dialing from talk mode

- 1 Press **(talk)**.
“Talk” flashes and the volume setting appears.
- 2 Press **(mem)**.
- 3 Enter a two-digit number (01-20) to select the memory location of the desired phone number.
The selected phone number is displayed. Then the number is dialed.

```
Talk
```



```
Talk
<High>
```

```
Talk 0:35
0123456789012
```

From the base

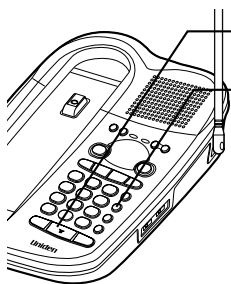

- 1 Press **speaker**.
- 2 Press **memory**.
- 3 Press the number keypad to select the memory location you wish to dial.
- 4 Press **speaker** to finish the call.



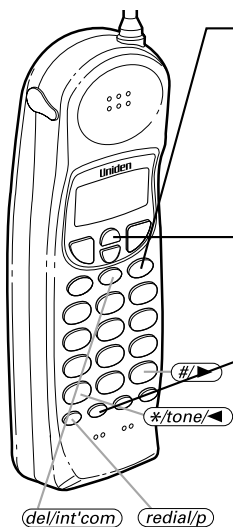









Editing a stored name and/or phone number

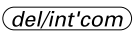

- 1 Press and hold **mem** until "Memory Store" is displayed.

```
Memory Store
01 UNIDEN CORP
02 JOHN DOE
```
- 2 Press **▲** and **▼** or enter a two-digit number (01-20) to select the memory location you would like to edit.
- 3 Press **select/ch**.
The following screen appears with the memory location number that you have selected in the display.

```
► Edit Memory01
Delete Memory01
Go Back
```

- 4** Press the  or  key to select "Edit Memory", then press  .
- ```
Store Name
UNIDEN CORP
```
- The following screen appears.  
The cursor flashes indicating that the display is ready for the name to be edited. When a name has not been stored, the cursor appears at the beginning of the second line.
- 5** Press , , , , or  to edit the name. (See page 24.)  
To edit only the phone number, skip this step.
- 6** Press  .
- ```
Store Number
000297102
```
- The following screen appears.
The cursor flashes indicating that the display is ready for the number to be edited.
- 7** Use the number keypad, , or  key to edit the phone number.
The phone number cannot exceed 20 digits. (See page 24.)
When the phone number is not to be edited, skip this step.
- 8** Press  .
- ```
Memory01 Stored
```
- The handset beeps and displays the confirmation screen. The memory storage is complete.
- For example, if you store a name and number into memory location number 01, the display shows "Memory01 Stored".
- After about 2 seconds, "Memory Store" is displayed.
- ```
Memory Store
01 UNIDEN CORP
02 JOHN DOE
```
- 9** Press  to return to standby mode.

Erasing a stored name and phone number

With the handset

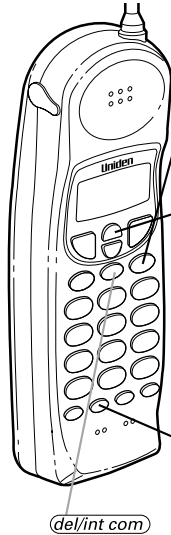

- 1** Press and hold **(mem)** until "Memory Store" is displayed.

```
Memory Store
01 UNIDEN CORP
02 JOHN DOE
```

- 2** Press **(▲)** and **(▼)** or enter a two-digit number (01-20) to select the memory location (01 - 20) you would like to edit.

```
Memory Store
01 UNIDEN CORP
02 JOHN DOE
```

- 3** Press **(select/ch)**.
The following screen appears with the memory location number that you have selected in the display.

```
► Edit Memory02
Delete Memory02
Go Back
```

- 4** Press **(▼)** to move the pointer down to "Delete Memory" command line.

```
Edit Memory02
► Delete Memory02
Go Back
```

- 5** Press **(select/ch)**. The following confirmation screen appears.

```
Delete Memory02?
Yes
► No
```

- 6** Press **(▲)** to move the pointer to "Yes".

- 7** Press **(select/ch)** or **(del/int'com)**.
There is a confirmation tone and the entry is deleted. The following screen appears.

```
Memory02 Deleted
```

- 8** After a few seconds, the display returns to the "Memory Store" screen. You may select another number to delete (return to step 2) or press **(mem)** to return to standby.

With the base

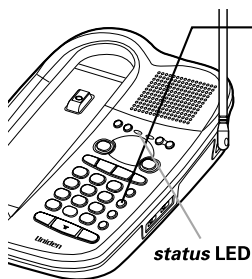

- 1** Press **memory** .
The **status** LED blinks.
- 2** Press **memory** again.
- 3** Enter the memory location number (0-9)
of the number you wish to delete. The
status LED goes out.
A confirmation tone indicates the
number has been erased.

NOTE

During a 3-way conversation, dialing is only possible from the handset.

3-way conferencing

The Uniden EXAI 985HS permits 3-way conversations between the handset, base, and outside line.

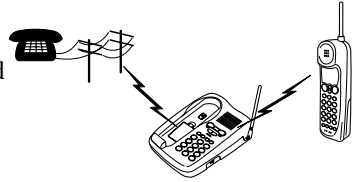

When speaking on the handset

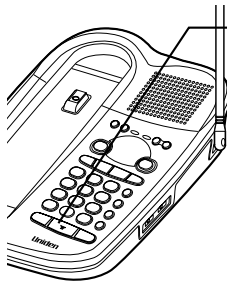

- 1 Press **speaker** on the base to join the 3-way conversation. This will set the 3-way conversation mode.
- 2 To hang up, press **speaker** on the base. The handset remains connected to the call.

When speaking on the base

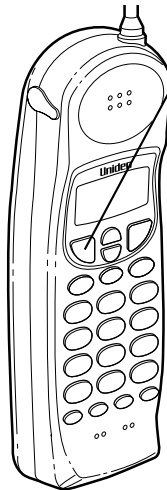

- 1 Press **talk** on the handset to join the 3-way conversation.
- 2 To hang up, press **talk** on the handset. The base remains connected to the call.

Caller ID service

You must subscribe to the Caller ID service from your telephone company to use this feature.

When the telephone rings, the Caller ID feature allows you to view the caller's name and phone number on the display before you answer the phone.

The handset displays the phone number of the incoming call, the name, time, and the number of calls. Additionally, you can dial the displayed number, and store the information for memory dialing.

When the telephone rings

NOTE

If you answer a call before the Caller ID message is received (Example: before the second ring), the Caller ID message will not appear.

NOTE

When the call is received via a telephone company that does not offer Caller ID service, the caller's phone number and name do not appear. (This includes international calls.)

NOTE

When the call is via a private branch exchange (PBX), the caller's phone number and name may not appear.

- 1 When the Caller ID message is received, the display shows the caller's phone number, along with the date and time. The incoming call information is stored in Caller ID record. If the Caller ID service includes the caller's name, the caller's name appears on the display (up to 15 letters).

Number of calls from the same phone number _____
The date and time received _____ 5/11 12:30PM 01
Caller's name _____ UNIDEN CORP
Caller's phone number _____ 800-297-1023

Here are some typical displays;

When the phone number and name data are received

```
5/11 12:30PM 01
UNIDEN CORP
800-297-1023
```

When invalid data is received

```
Incomplete Data
```

When a private name is received

```
5/11 12:30PM 01
Private Name
800-297-1023
```

When a private number is received

```
5/11 12:30PM 01
UNIDEN CORP
Private Number
```

When an unknown name is received

```
5/11 12:30PM 01
Unknown Name
800-297-1023
```

When an unknown number is received

```
5/11 12:30PM 01
UNIDEN CORP
Unknown Number
```

- 2 When the telephone is answered, the display changes to "Talk".

NOTE

Data errors appear as "■ ■ ■".

```
5/11 12:30PM 01
UNI■EN CORP
800-2■-1023
```

NOTE

If a call comes in via a telephone system that does not offer Caller ID service, no information is stored.

NOTE

"End" appears when you have received all messages in the Caller ID list. Press  repeatedly to return to the summary screen.

NOTE

Each message can be up to 15 characters for the phone number and the name.

Viewing the Caller ID Message list

The Caller ID list stores information for up to 50 incoming calls - even unanswered calls.

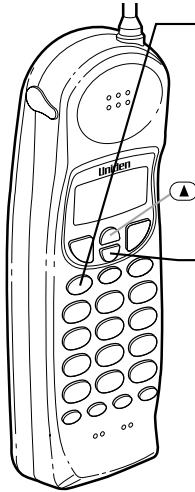



- 1 Press  .
The summary screen appears. The screen shows the number of new messages and total messages.

```
New :01
Total:02
```

- 2 Press  to display the latest caller ID message.

```
5/17 12:30PM 03
UNIDEN CORP
800-297-1023
```

- 3 Press  to see the next message.
Or press  to see previous message.

- 4 Press  to return to standby.

Deleting information from the Caller ID list

The EXAI 985HS stores up to 50 messages. If the phone receives the 51st message, the oldest one in the list is automatically deleted.

Caller ID data can also be deleted manually.

Deleting a Caller ID message

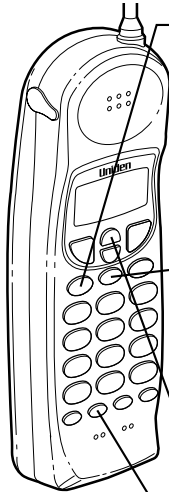

- 1** Press **(call id)**.
Display the message to be deleted from the Caller ID list by pressing **(▲)** or **(▼)**.

```
5/17 12:30PM 03
UNIDEN CORP
800-297-1023
```

- 2** Press **(del/int'com)**. The following screen appears.

```
Delete Message?
#Yes
No
```

- 3** Press **(▲)** or **(▼)** to select "Yes" or "No".

- 4** Press **(select/ch)** or **(del/int'com)**.

When the pointer is at "Yes":

A tone sounds and the Caller ID message is deleted. The next Caller ID message is then displayed.

When the pointer is at "No":

The display returns to the Caller ID display.

NOTE

If you get an incoming call, the deleting operation is canceled and the telephone returns to standby so you can answer the call.

Deleting all Caller ID names/numbers

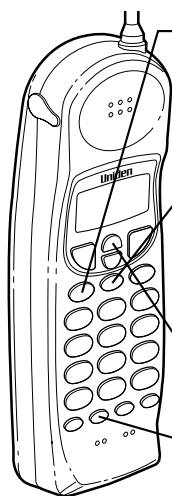

1 Press **call id** .

```
New :01
Total:02
```

2 Press **del/int'com** . The following screen appears.

```
Delete All?
Yes
No
```

3 Press **▲** or **▼** to select "Yes" or "No".

4 Press **select/ch** or **del/int'com** .

When the pointer is at "Yes":

A tone sounds and all stored Caller ID messages are deleted.

```
Total:00
```

When the pointer is at "No":

The display returns to the summary screen.

```
New :01
Total:02
```

Using the Caller ID list

Calling a party from the Caller ID list

You can place a call from the Caller ID list.
The EXAI 985HS stores up to 50 messages.

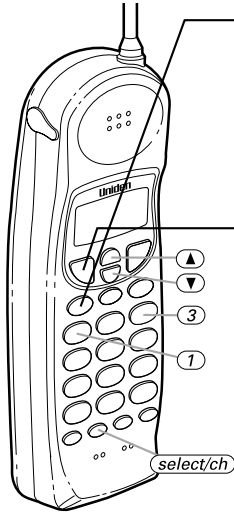

- 1 Press **(call id)**.
Select the phone number that you want to dial by pressing **(▲)** or **(▼)**.

```
5/17 12:30PM 03
UNIDEN CORP
800-297-1023
```

- 2 Press **(talk)**.

```
Talk
8002971023
```

The displayed phone number will be dialed.

NOTE

You cannot make a call from the Caller ID list if your EXAI 985HS is connected to private branch exchange (PBX).

NOTE

When a long distance call has been set, "1" appears in the display.

Long Distance calls and Area code

Pressing **(1)** while the Caller ID information is displayed (in step 1) will place a "1" in the display to set up for a long distance call.

```
5/17 12:30PM 03
UNIDEN CORP
1-800-297-1023
```

Dial edit

Press **(del/int'com)** to move the cursor to the left, make your changes and then press **(talk)**. This will not change the number in the Caller ID list memroy.

If you want to save this new number, store the information in memory (see page 23).

```
UNIDEN CORP
8002971023█
```

Storing Caller ID messages in Memory dialing

The phone number of the party on the Caller ID list can be stored in memory dialing.

NOTE

You can not store a Caller ID message if no phone number appears in the message.

NOTE

If no key is pressed for more than 20 seconds, an error tone sounds and the telephone returns to the standby mode.

NOTE

If there is an incoming call or page, memory storage is canceled and the telephone is set to receive the incoming call or page.

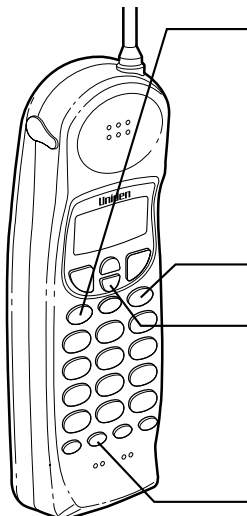

1 Press **(call id)**.

Select the phone number to be stored from the Caller ID list by pressing **(v)** or **(^)**.

```
5/17 12:30PM 03
UNIDEN CORP
800-297-1023
```

2 Press **(mem)**.

3 Press **(v)** and **(^)** or enter a two-digit number (01-20) to select the memory location.

```
Select Location
01 UNIDEN CORP
02 JONE DOE
```

4 Press **(select/ch)**.

A tone will sound. The number is stored in memory, and the display returns to the Caller ID list.

```
5/17 12:30PM 03
UNIDEN CORP
800-297-1023
```

NOTE

If a message has already been stored in the selected memory numbers location, a confirmation screen is displayed. Press **(^)** to select "Yes". Press **(select/ch)** to overwrite. The display returns to the Caller ID list.

```
Replace Memory?
Yes
^ No
```

Using "Caller ID with call waiting" service

"Caller ID" and "Call waiting" are separate services. CIDCW (Caller ID on Call Waiting) performs the same as regular Caller ID on a call waiting number. You must subscribe to the "Caller ID with call waiting (CIDCW)" service from your telephone company before you can use the following features. The "Call waiting" service can also be used independently. Please contact your telephone company for details.

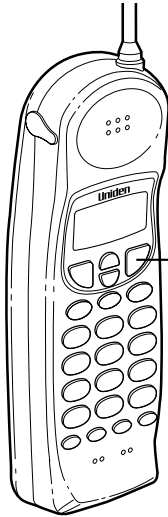

- 1 When a new incoming call arrives during your current telephone call, the phone number and the name of the caller are displayed.

```
Talk 10:30  
UNIDEN CORP  
800-297-1023
```

- 2 Press **(flash)**.
You will be able to talk with the person that has just called. The first caller will be put on hold.
- 3 To return to the first caller, press **(flash)** again.



When CIDCW is set to **Off** in the Caller ID setup menu (see page 13), you can press the **(options)** key after receiving a call waiting call and view a list of ways to handle the new call. Choose an option using the **(▲)** and **(▼)** keys and press **(select/ch)** to activate.

Call waiting features

Your EXAI 985HS gives you new options for call waiting. At the touch of a button, you can ask the caller to hold or conference them into your current call. You may be required to subscribe to call waiting and call waiting options to use these features. Not all features are available in all areas. Check with your local telephone company for details.

NOTE

You can also answer a call waiting call immediately by pressing the *(flash)* key. The first caller will be placed on hold. To return to the original caller, press *(flash)* again.

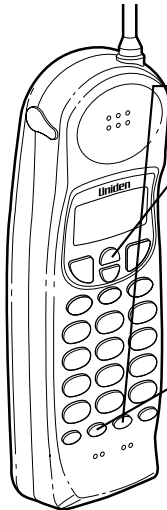

Selecting an Option

- 1 When you receive a call waiting call, press *(options)* for a list of options.
- 2 Press the *(▼)* or *(▲)* key to select an option.

```
1 Ask to Hold
2 Tell Busy
3 Answer/Drop 1
```

- 3 Press *(select/ch)*.
A confirmation screen will appear.

```
Talk 0:15
Answer/Drop 1st
```

Your EXAI 985HS is pre-programmed with seven call waiting options. You may select to ask the calling party to hold, send them a **busy** message, or **conference** them into the current call. You may also select to **answer and drop** the first caller or, at any time, choose to **drop the first** or **drop the last** caller.

Check with your local telephone company for a full list of options.

The integrated answering device

The EXAI 985HS has a built-in answering system that answers and records incoming calls.

You can also use your answering system to record a conversation, leave a voice memo message for others who use the phone, or to announce a special message to callers when you're away from your phone.

Features

- Digital Tapeless Recording
- 15 minutes of Recording Time
- Selective Greetings (Outgoing Messages)
- Message Received Time and Day Announcement
- Remote Message Retrieval and Room Monitor
- Toll Saver
- Conversation Recording

Digital Tapeless Recording allows you to quickly review, save or delete the messages. You'll never have to worry about a tape wearing out, jamming, or resetting improperly.

The Integrated Answering System is easy and convenient to use, but please read through all of the instructions carefully.

NOTE

When the answering system is full, **FL** displays on the base and the system announces "No Remaining Time". You should delete some messages so that the system can record new messages.

NOTE

Press and hold **▶▶** or **◀◀** to quickly scroll through the numbers on the display.

NOTE

If you don't complete the clock setting within two minutes, the system returns to standby.

Setting up your answering system

Turning the answering system on/off

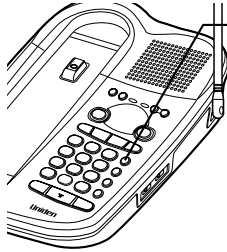

- 1 To turn the answering system on, press **(ans on/off)**. The current greeting message is played and a tone sounds.
- 2 To turn the answering system off, press **(ans on/off)** again.

Setting the clock

The clock on EXAI 985HS Answering System starts when power is applied to the base. Follow these steps to set the clock to the correct time.

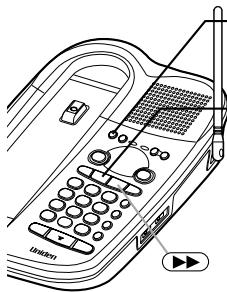

- 1 Press and hold **(clock)** until a tone sounds.
- 2 First, press **▶▶** or **◀◀** until the correct day of the week is announced. (Numbers 0 through 6 display on the base as each day is announced.) Press **(clock)** again to select the day.
- 3 Next, press **▶▶** or **◀◀** until you hear the correct hour setting. Numbers 1 through 12 display on the base as each hour is announced. Press **(clock)** again to select the correct time.
- 4 Press **▶▶** or **◀◀** until you hear the correct time setting. Numbers 1 through 59 display on the base as each minute is announced. Press **(clock)** again to select the correct time.
- 5 The LED displays an **A** or **P**. Press **▶▶** or **◀◀** until you hear the correct AM/PM setting.
- 6 Press **(clock)** again to end the time/day setting. The EXAI 985HS announces the time that you have set.

Setting your greeting

When you receive a call, the answering system automatically plays either a preset message or your own personal greeting.

NOTE

Position yourself as near to the base as possible and speak clearly when recording your greeting.

NOTE

You can record a greeting up to 30 second.

▼ Preset Message

The following message is prerecorded:

"Hello, no one is available to take your call. Please leave a message after the tone."

▼ Recording your personal greeting

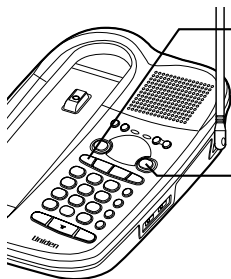

1 Press and hold **greeting** until you hear a tone. Start recording your message immediately after you hear the tone end.

2 When you finish recording your message, press **greeting** or **play**. A tone sounds and your message plays back on the phone.

▼ Choosing between two greetings

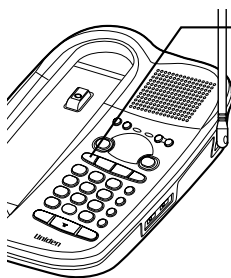

1 Press **greeting** to play the outgoing message.

2 While the message is playing, press **greeting** again. This switches between the two options.

NOTE

You have the choice of deleting your personal outgoing message or simply overwriting your old outgoing message with a new one. To overwrite, perform the steps above in "Recording your personal greeting".

Selecting the message record time

You can set your answering system to record messages up to one or four minutes long.

One minute option:
move the **REC TIME** switch to **1**.

Four minute option:
move the **REC TIME** switch to **4**.

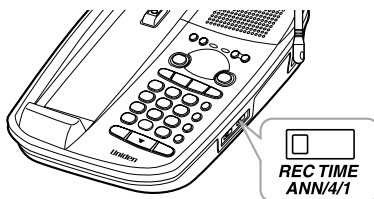

▼ Announce only feature:

The announce only feature plays an outgoing message, but it will not allow the caller to leave a message. Move the **REC TIME** switch to the **ANN** position.

The message counter LED displays "R" when system is on standby.



Prerecorded outgoing message for Announce only feature is:

"Hello, no one is available to take your call."









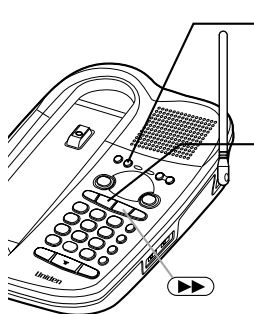

Selecting a PIN code

To play your messages from a remote location, you will need to enter a two-digit Personal Identification Number (PIN) code (00-99). To select a PIN, perform the following steps.



Press and hold  or  to quickly scroll through numbers on the display.



- 1** On the base, press and hold  button until a tone sounds, and the LED displays .
- 2** To set the first number, press  or  to scroll from . When the desired number appears in the display, press .
- 3** To set the second number, press  or  to scroll from . When the desired number appears in the display, press . Then the entered PIN code is announced.

Setting ring time switch

The ring time/toll saver switch allows you to set the number of rings the caller hears before the answering system plays your outgoing message. You can set the switch to answer after two rings or after four rings. Once the greeting has started, you can stop it when you pick up the call at the handset or base.

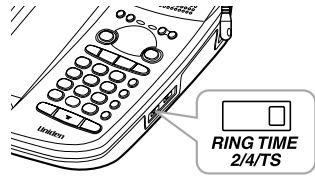

If you answer at another phone extension and the greeting has started, you cannot stop the message. Wait until your greeting is complete before starting your conversation.

In the **TS** (Toll Saver) position, the answering system picks up after two rings if you have new messages, and after four rings if there are none. This way, if you call long distance to check your messages, you can hang up after the third ring to avoid billing charges.

Using your answering system

NOTE

To stop playing your messages, press **(play)** again.

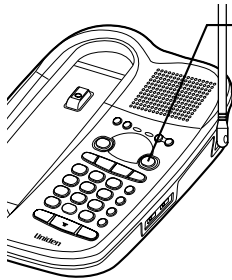

Playing your message

The base LED shows the number of total messages on the display. If the display is blinking, then there are new messages waiting for you. The EXAI 985HS is designed to play your new messages first. After you play your new messages you can then play your old messages.



- 1** Press **(play)**. The system announces the number of new and old messages, then the new incoming messages are played. The time and day each message was received is announced after the message is played, and the message counter LED displays the number of the current message.
- 2** When all new messages have played, a tone is heard. The message counter LED stops flashing to indicate that all of the new messages have been reviewed.
- 3** After you have reviewed all your messages, you can play your old messages again. Press **(play)** and follow the instructions above.

NOTE

Pressing  before 2 seconds (4 seconds from remote) of the message has played causes the system to scan back one message. If you press  after two seconds (four seconds from remote) the system starts to play the same message from the beginning.

TIP

If you have several messages, press and hold  until you return to the message you want to replay.

NOTE



Each time  is pressed, the system scans forward one message.

NOTE

If you have several messages, press and hold  to find the message you want to play.

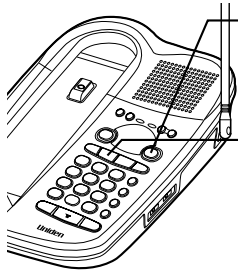

Repeating a message

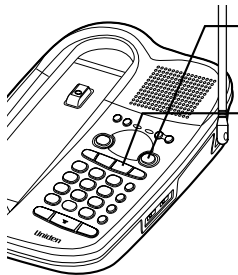

- 1 Press  to review your message. The number of stored messages is announced.
- 2 After a message has played for a few seconds, press  to repeat the message.
- 3 Press  at any time to stop reviewing messages and return to standby. The message counter LED shows the total number of messages remaining on the system.

Skipping a message



- 1 Press  to review your messages. The number of messages is announced.
- 2 Press  at anytime to skip to the next message.
- 3 Press  at any time to stop reviewing your messages and return to standby. The message counter LED shows the total number of messages on the system.

NOTE

When you press **(delete)**, you are permanently deleting the message. Once deleted, the message cannot be replayed.

NOTE

The voice memo function is completely independent of the outgoing message. It's handy for leaving others a quick message.

NOTE

A voice memo message will be stored as a typical recorded message.

NOTE

Position yourself as near to the base as possible and speak clearly.

Deleting a message

▼ Deleting individual message

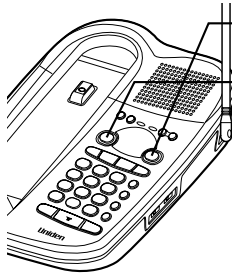

- 1 Press **(play)** to review your message.
- 2 If you decide to delete a message, press **(delete)** anytime during the message. The system beeps and immediately goes to the next message.
- 3 After you have played all of your messages, a long tone sounds on the base speaker.

▼ Deleting all messages

Press and hold **(delete)** while the system is in standby. A tone sounds when all messages are deleted. If there is a message you have not reviewed, you cannot delete all messages at once.

Voice memo

The voice memo function allows the user to record a message (up to 10 minutes) on the base.

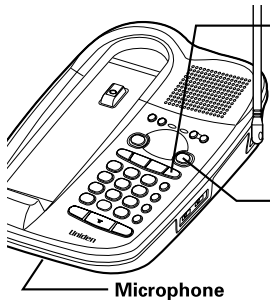

- 1 Press and hold **(voice memo)**, until you hear a long beep. The message counter LED blinks.
- 2 Speak into the microphone.
- 3 When you have finished, press **(voice memo)** or **(play)** to stop recording. The system returns to standby.

NOTE

A recorded conversation is treated as a typical message and will be added to the stored messages.

Recording a conversation

You can record up to 10 minutes of conversation while you are making your call from the handset.

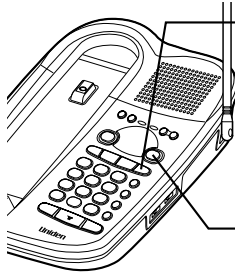

1 During the conversation from the handset. Press and hold **voice memo** on the base. The unit begins recording and the LED blinks. Both parties can hear tones every 15 seconds.

2 To stop the recording, press **voice memo** or **play**.

NOTE

You cannot record a conversation while you are speaking on the base.



NOTE

During the remote operation,  displays on the base.



NOTE

You must enter a command within 15 seconds of entering command waiting mode or the answering system automatically hangs up and returns to standby.



NOTE

The system will only playback messages for four minutes and then it returns to command waiting mode. To continue playing your message, press # then 2 again within 15 seconds

Remote access away from home

You can operate your answering system from a remote location using any touch-tone telephone. Use this function to check for recorded messages, to play or delete messages, even to record a new outgoing message, and to monitor sounds in the room. Prior to accessing the system remotely, you must have selected a PIN code (refer to page 45).

- 1 Call your telephone number.
- 2 While the answering machine is activated, press # and your PIN code.
- 3 The answering system announces the time and day and the number of messages stored in memory. Then the message playback automatically begins.
- 4 You may continue to listen to your message, or you may select a command from the following chart.

Command	Function
# then 1	Repeat
# then 2	Playing your messages
# then 3	Skipping a message
# then 4	Deleting a message
# then 5	Stop message playback
# then 6	Answering system on
# then 7	Voice memo record/stop
# then 8	Outgoing message record/stop
# then 9	Answer system off
# then *	Room monitor

- 5 After all of your messages have played, or the playback time exceeds 4 minutes, you will hear intermittent tones indicating that the system is in the command waiting mode. You may enter another command at this time from the chart above.
- 6 When you are finished, hang up to exit the system. The answering system automatically returns to standby.



NOTE

You cannot use # and * while the new messages are playing. Press # then 5 to stop message playback first and go to step 5.



NOTE

If you enter an incorrect PIN code three times, an error tone sounds and the phone automatically hangs up.

Remote room monitor

You can call your answering system from any touch-tone phone and monitor sounds in the room where your base is installed.

- 1 Call your telephone number.
- 2 While the answering machine is activated, press # and your PIN code.
- 3 The answering system begins announcing the time and day.
- 4 Press # then 5 to stop the message.
- 5 Press # then *. You hear sounds in the room where your phone is installed. After 15 seconds, the answering system returns to the command waiting mode.
- 6 Press # then * to monitor the room for another 15 seconds. Or select another remote function. Or hang up to exit the system. The answering system automatically returns to standby.

Turn on the answering machine remotely

If you have forgotten to turn on your answering machine, you can turn it on remotely from any touch-tone telephone.

- 1 Call your telephone number.
- 2 Wait ten rings until the machine answers. You hear a beep.
- 3 Press # and enter your PIN code within two seconds. The answering system begins to announce the time and day stamp.
- 4 Press # then 5 to stop the announcement.
- 5 Press # then 6 to turn the answering system on.
- 6 Hang up the phone and subsequent calls will be answered by the machine.

Changing the digital security code

NOTE

If the handset battery pack is completely discharged or the battery pack is removed, the digital security code will be lost. If this happens, a new security code is set automatically the next time the battery pack is charged.

The digital security code is an identification code used to connect the handset and the base unit. Normally, setting the code is not necessary.

The first time you charge your handset, the security code is automatically set. (See page 4.)

In the rare situation that you suspect another cordless telephone is using the same security code, you can change the code.

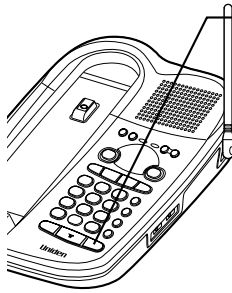

- 1 Remove the handset from the base unit. Press page/int'com.
- 2 While the handset is emitting the paging sound, place the handset on the base unit holding page/int'com. The paging tone stops. Leave the handset on the base longer than 3 seconds. A random, new security code is set.

ADDITIONAL

INFORMATION

Installing the beltclip

To attach the beltclip

Insert the beltclip into the holes on each side of the handset. Press down until it clicks.

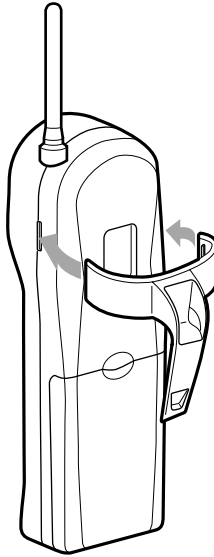

To remove the beltclip

Pull both sides of the beltclip to release the tabs from the holes.

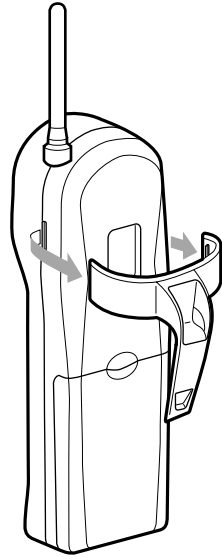

Headset installation

With the HS910 headset, you can have the convenience of hands free communication while using your cordless phone.

- 1** Place the headset on your head so the speaker covers your ears. The headband can be adjusted to accommodate a variety of head sizes. The other end of the headband should rest comfortably against the side of your head above your ear. Do not put the end of the headband against the other ear.

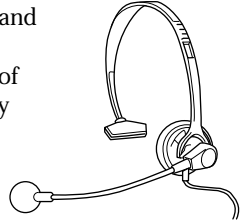

- 2** The microphone arm swings over the top of the headset so you can wear the headset on the left or right ear. Position the flexible arm so the microphone is about 2 inches away from the mouth.

- 3** To use the headset, pull back the headset cover and plug the headset cord into the 2.5 mm jack on the side of the handset. This will automatically disable the speaker on the phone and activate the microphone on the headset. During a call, you may plug or unplug the headset without interrupting your conversation.

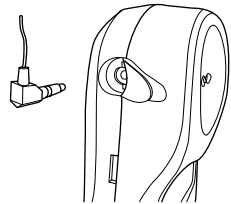

Note on power sources

Battery replacement and handling

When the operating time becomes short, even after a battery is recharged, please replace the battery. With normal usage, your battery should last about one year. Please contact your place of purchase or the Uniden Parts Department for a replacement battery. (See page 5)

Power Failure

During the period that the power is off, you will not be able to make or receive calls with the telephone.

RECYCLING NICKEL-CADMIUM BATTERIES



NICKEL-CADMIUM BATTERIES MUST BE DISPOSED OF PROPERLY.

Nickel-cadmium cells are used in the battery pack. Please take your used nickel-cadmium battery packs to a store that recycles nickel-cadmium batteries.

Caution

- Use the specified battery pack.
- Do not remove the battery from the handset to charge it.
- Never throw the battery into a fire, disassemble it, or heat it.
- Do not remove or damage the battery casing.

Maintenance

When slightly dirty

Wipe with a soft, dry cloth.

When very dirty

Wipe with a soft cloth that has been dampened with mild dishwashing detergent. Dry with a dry cloth.

When the charging terminals become dirty

Wipe with a dry cloth or a pencil eraser, if necessary.

Caution

Do not use paint thinner, benzene, alcohol, or other chemical products. Doing so may discolor the surface of the telephone and damage the finish.

General Information

The EXAI 985HS complies with FCC Parts 15 and 68.
Operating Temperature: 0°C to +50°C (+32°F to +122°F)

AC Adapter Information

AC Adapter part number: AD-420
Input Voltage: 120V AC 60Hz
Output Voltage: 9V DC 350 mA

Battery Information

Battery part number: BT-905
Capacity: 600 mAH, 3.6V
Battery Use Time (per charge)
From fully charged:
Talk Mode duration 7 hours
Standby Mode duration 7 days



If the handset is left off of the base, the actual Talk Mode duration will be reduced respective to the amount of time the handset is off the base.

Recharge your phone on a regular basis by returning the handset to the base after each phone call. When the operating time becomes short, even after the battery is recharged, please replace the battery. With normal usage, the battery should last about one year.

Replacement batteries may be purchased at your local Uniden dealer or by contacting the Uniden Parts Department (800) 554-3988. Hours are from 7:00 a.m. to 5:00 p.m. Central Time, Monday through Friday. We can also be reached on the web at www.uniden.com

Troubleshooting

If your phone is not performing to your expectations, please try these simple steps first.

Symptom	Suggestion
The status LED won't light when the handset is placed in the base unit.	<ul style="list-style-type: none"> • Make sure the AC adapter is plugged into the base unit and wall outlet. • Make sure the handset is properly seated in the base unit. • Make sure the charging contacts on the handset and base unit are clean.
The audio sounds weak and/or scratchy.	<ul style="list-style-type: none"> • Make sure that the base unit antenna is in a vertical position. • Move the handset and or base unit to a different location away from metal objects or appliances and try again. • Press (<i>select/ch</i>) to help eliminate background noise during the conversation. • Make sure that you are not too far from the base.
Can't make or receive calls.	<ul style="list-style-type: none"> • Check both ends of the base unit telephone line cord. • Make sure the AC adapter is plugged into the base unit and wall outlet. • Disconnect the AC adapter for a few minutes, then reconnect it. • Reset the digital security code (See page 53). • Make sure (<i>talk</i>) is pressed.
The handset doesn't ring or receive a page.	<ul style="list-style-type: none"> • The battery pack may be weak. Charge the battery on the base unit for 12-15 hours. • The handset may be too far away from the base unit. • Place the base unit away from appliances or metal objects. • Reset the digital security code (See page 53).

Symptom	Suggestion
Severe noise interference.	<ul style="list-style-type: none"> • Keep the handset away from microwave ovens, computers, remote control toys, wireless microphones, alarm systems, intercoms, room monitors, fluorescent lights and electrical appliances. • Move to another location or turn off the source of interference.
The Caller ID disappears.	<ul style="list-style-type: none"> • The handset was picked up before the second ring.
The Caller ID does not display	<ul style="list-style-type: none"> • The call was placed through a switch board. • Call your local telephone company to verify your Caller ID service is current. • Make sure that the CIDCW option is set to "On" or "Off".
The answering system does not work.	<ul style="list-style-type: none"> • Make sure the base unit is plugged in. • Make sure that the answering system is turned on. • Make sure that the message record time is not set to ANN. (See page 45)
Messages are incomplete.	<ul style="list-style-type: none"> • The incoming messages may be too long. Remind callers to leave a brief message. • The memory may be full. Delete some or all of the saved messages.
After a power failure, the outgoing message is deleted.	<ul style="list-style-type: none"> • Record your greeting again. The default message remains.
No sounds on the base unit speaker during call monitoring or message playback.	<ul style="list-style-type: none"> • Adjust the speaker volume on the base unit.
Cannot access remote call-in features from another touch-tone phone.	<ul style="list-style-type: none"> • Make sure you are using the correct PIN code. • Make sure that the touch-tone phone you're using can transmit the tone for at least two seconds. If it cannot, you may have to use another phone to access your message.

Index

0 - 9

3-way conferencing.....32

A

Answering device

Features.....42

Setting up.....43

Using.....47

B

Base ringer switch.....18

Battery pack

Preparing and charging..11

Replacement and
handling.....56

C

Caller ID

Caller ID service.....33

Call Waiting.....40

Deleting.....36

Using.....38

Viewing.....35

Connection.....7

D

Dialing mode.....8

Digital security code.....4, 53

E, F, G

Earpiece volume.....18

H

Headset installation.....55

I, J, K, L

Installing the beltclip.....54

Intercom.....21

M, N, O

Maintenance.....56

Making a call.....15

Memory dialing

Erasing a stored name
and phone number.....30

Making a call
with memory dialing.....26

Storing phone

numbers and names.....23

Mounting the base unit

to a wall.....9

Mute.....17

P, Q

Package contents.....5

R

Receiving a call.....16

Redialing a call.....19

Handset ringer switch.....18

Handset ringer tone.....18

S

Setting up the Base unit.....6

Setting up the Handset.....11

Setting up your answering
system

Selecting a PIN code.....45

Selecting the

message record time.....45

Setting ring time switch.....46

Setting the clock.....43

Setting your greeting.....44

Turning the answering

system on/off.....43

T

Transferring a call.....22

Troubleshooting.....58

U, V, W, X, Y, Z

Using your answering system

Deleting a message.....49

Playing your message.....47

Recording a

conversation.....50

Remote access

away from home.....51

Remote room monitor.....52

Repeating a message.....48

Skipping a message.....48

Voice memo.....49

At Uniden, we'll take care of you!

If you need any assistance with this product, please call our Customer Hotline at

1-800-297-1023

PLEASE DO NOT RETURN THIS PRODUCT TO THE PLACE OF PURCHASE.

Our Uniden representatives will be happy to help you with any matters regarding the operation of this unit, available accessories, or any other related matters.

Thank you for purchasing a Uniden product.

Hours: M-F 7:00 AM to 7:00 PM CST.

THANK YOU

FOR PURCHASING A UNIDEN PHONE!

Uniden®

Covered under one or more of the following U.S. patents:

4,511,761	4,523,058	4,595,795	4,797,916	5,381,460
5,426,690	5,434,905	5,491,745	5,533,010	5,574,727
5,650,790	5,660,269	5,661,780	5,663,981	5,671,248
5,717,312	5,754,407	5,768,345	5,787,355	5,838,721

©2000 Uniden America Corporation

All rights reserved • Printed in China UCZZ01624GZ

manuals.com. All Manuals Search And Download.

Free Manuals Download Website

<http://myh66.com>

<http://usermanuals.us>

<http://www.somanuals.com>

<http://www.4manuals.cc>

<http://www.manual-lib.com>

<http://www.404manual.com>

<http://www.luxmanual.com>

<http://aubethermostatmanual.com>

Golf course search by state

<http://golfingnear.com>

Email search by domain

<http://emailbydomain.com>

Auto manuals search

<http://auto.somanuals.com>

TV manuals search

<http://tv.somanuals.com>