



E X I 6 9 6 0

OWNER'S MANUAL

900 MHz Cordless

Phone with

Caller ID

THANK YOU

FOR PURCHASING A UNIDEN PHONE!

Uniden®

Covered under one or more of the following U.S. patents:

4,511,761 4,523,058 4,595,795 4,797,916 5,381,460 5,426,690
5,434,905 5,491,745 5,533,010 5,574,727 5,650,790 5,660,269
5,661,780 5,663,981 5,671,248 5,717,312 5,754,407 5,768,345
5,787,356 5,838,721

© 1999 Uniden America Corporation

Download from www.Somanuals.com. All Manuals Search And Download.

All rights reserved. Printed in China.

At Uniden, we'll take care of you!

**If you need any assistance with this product,
please call our Customer Hotline at:**

1-800-297-1023

PLEASE DO NOT RETURN THIS PRODUCT TO THE PLACE OF PURCHASE.

**Our Uniden representatives will be happy to help you
with any matters regarding the operation of this unit,
available accessories, or any other related matters.**

Hours: M-F 7:00 a.m. To 7:00 p.m., Central Standard Time

Thank you for purchasing this Uniden product.

CONTENTS

OF YOUR OWNER'S MANUAL

CONTENTS

Introduction	2
• Welcome	2
• Features	2
• Included in Your Package	3
Installing and Adjusting Your Phone	4
• Desk/Tabletop Installation	4
• Wall Installation	5
• Installing the Handset Battery Pack	11
• Charging the Battery Pack	12
• Cleaning the Battery Contacts	12
• Setting the Pulse/Tone Switch	13
• Adjusting the Ringer and volume Controls	13
• Using the Page Feature	14
• Automatic Digital Code Security	14
Using Your New Phone	15
• Making and Receiving Calls	15
• Flash and Call Waiting	15
• Storing a Phone Number in Memory	16
• Editing a Phone Number in Memory	17
• Erasing a Number from Memory	18
• Using Memory Dialing	19
• Chain Dialing	19
• Using Caller ID	20
• Using Redial	25
• Using the Tone Feature	25
• Selecting a Different Channel	25
• Traveling Out-of-Range	26
Troubleshooting	27
• Quick Reference Chart	27
Specifications	29

Fold out the front cover of this reference guide to use the handy "Controls and Functions" page for reference.

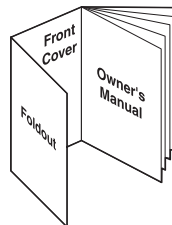

Introduction

Installing and Adjusting

Using Your New Phone

Troubleshooting

Specifications

WELCOME

Congratulations on your purchase of the Uniden EXI 6960 cordless telephone. This phone is designed for reliability, long life, and outstanding performance.

FEATURES

- 900 MHz Technology
- 3-line Backlit Display
- Face Up/Face Down Charging
- 32 Digit Redial
- Page/Find
- Handset Earpiece and Ringer Volume Control
- Call Waiting Caller ID
- 30 Number Caller ID Memory
- 10 Memory Dial Locations
- Pulse/Tone Dialing
- 7 Hour Talk Time
- Hearing Aid Compatible

The EXI 6960 features include *AutoTalk*[™] and *AutoStandby*[™]. *AutoTalk* allows you to answer a call by just removing the handset from the base so you don't have to waste time pushing buttons or flipping switches. *AutoStandby* allows you to hang up by simply returning the handset to the base.

The *UltraClear Plus*[™] true compander circuitry virtually eliminates background noise. This innovative technology, together with 40 different channels, provides you with the best possible reception during all your conversations.

To protect you against misbilled calls which might result from your phone being activated by other equipment, the EXI 6960 has *Random Code*[™] digital security which automatically selects one of over 65,000 digital security codes for the handset and base. Also, the *AutoSecure*[™] feature electronically locks your phone when the handset is in the base.

To get the most from your phone, please read this reference guide thoroughly. Also, be sure to complete the product registration form and mail it in.

Be sure to visit our web site at: www.uniden.com.

INCLUDED IN YOUR PACKAGE

TIP

To get the most from your phone, please read this reference guide thoroughly. Also be sure to complete and mail the product registration form.

NOTE

If any of these items are missing or damaged, contact the Uniden Parts Department at (800)554-3988. Hours are from 8:30 a.m. to 5:00 p.m. Central Time, Monday through Friday. We can also be reached on the web at www.uniden.com.



Handset



Base

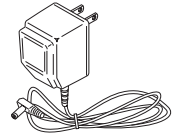

AC Adapter

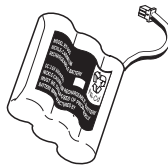

Rechargeable Battery

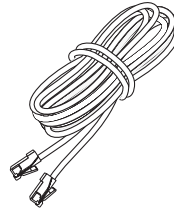

Long Telephone Cord

- This Owner's Manual
- Precautions and Important Safety Instructions
- Registration Card



When choosing a location for your phone, keep the base unit and the handset away from electrical noise caused by objects like motors and fluorescent lighting.

DESK/TABLETOP INSTALLATION

- 1) Plug the AC adapter cord into the DC input jack on the back of the base, then place the AC adapter cord inside the molded strain relief.

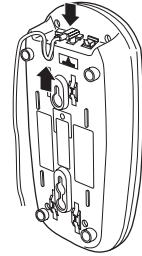

- 2) Plug one end of the long telephone cord into the **TEL LINE** jack on the base, then place the telephone cord into the right molded channel cord holder.

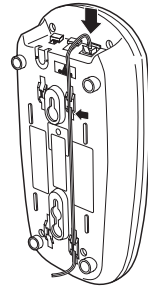

- 3) Plug the other end of the long telephone cord into the telephone wall jack. (*Remember, the phone must be fully charged before you can use it.*)

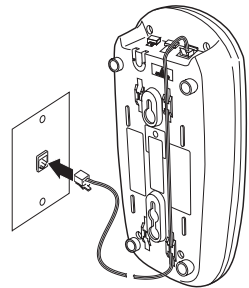

INSTALLING
AND ADJUSTING YOUR PHONE



Place the power cord so that it does not create a trip hazard or where it could become chafed and create an electrical hazard or fire.

- 4) Plug the AC adapter into a standard 120 V AC wall outlet.

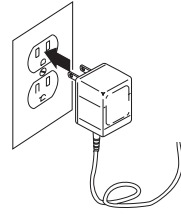

Use only the Uniden AC adapter supplied with this phone and DO NOT use an outlet controlled by a wall switch.



Before using your phone, fully charge the Nickel-Cadmium battery pack for 15-20 hours.

- 5) Raise the antenna to a vertical position.

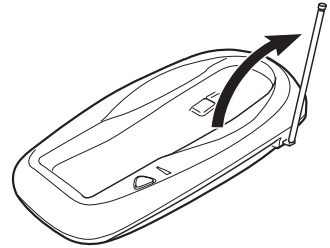

WALL INSTALLATION

▼ *Setting the Handset Retainer for Wall Mounting*

- 1) Remove the handset retainer on the base by sliding it upward.

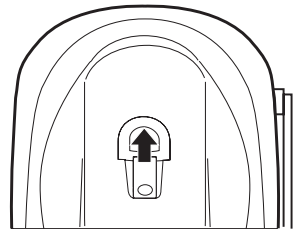

- 2) Flip the handset retainer over so the tab is facing up.



- 3) Slide the handset retainer back onto the base.

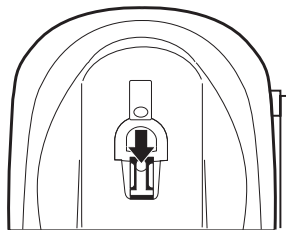

▼ *Standard Wall Plate Mounting*

This phone can be mounted on any standard telephone wall plate.

- 1) Plug the AC adapter into the DC input jack on the back of the base, then place the AC adapter cord inside the left molded channel cord holder.

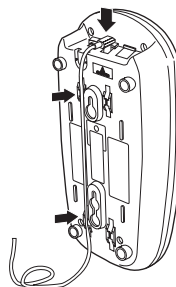

- 2) Plug a short telephone cord into the **TEL LINE** jack on the base, then place the telephone cord inside the right molded channel cord holder.

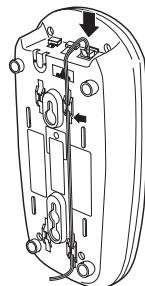

DO NOT use an outlet controlled by a wall switch.



Before you plug the other end of the telephone cord into the modular jack on the wall, charge the battery (refer to "Charging the Battery Pack," page 12).

- 3) Plug the other end of the cord into the wall jack. (*Remember, the phone must be fully charged before you can use it.*)

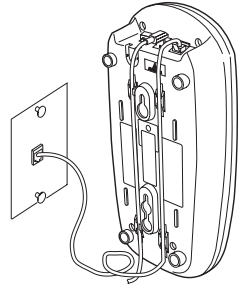

- 4) Place the base on the two posts of the wall plate and slide it downward to secure.

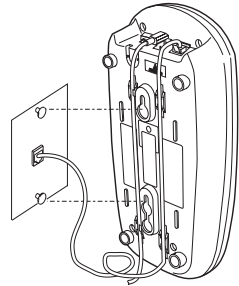

- 5) Plug the AC adapter into a standard 120 V AC wall outlet that is not controlled by a wall switch.

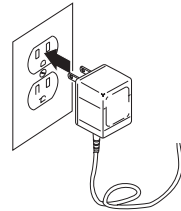

- 6) Raise the antenna on the base.

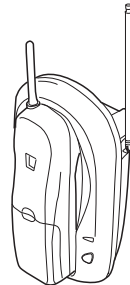

▼ *Direct Wall Mounting*

If you don't have a standard wall plate, you can mount your phone directly to the wall. Before mounting your cordless telephone, consider the following:

- Select a location away from electrical cables, pipes, or other items behind the mounting location. Inserting screws into areas such as this can be hazardous.
- Try to mount your phone within 10 - 15 feet of a working phone jack in order to avoid excessive cord length. Remember, you are not mounting your phone to a wall plate with a built-in phone jack.
- If the selected mounting area has no wooden support beams directly behind it, you will need the appropriate anchoring devices in order for the wall to properly support your phone.

- 1) Insert two mounting screws into the wall, with their appropriate anchoring device if necessary, 3-15/16 inches apart. Allow about 3/16 of an inch between the wall and screw heads for mounting the phone.

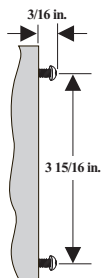

- 2) Set the handset retainer. (*Refer to "Setting the Handset Retainer for Wall Mounting" on page 5.*)
- 3) Plug the AC adapter into the DC input jack on the back of the base and place the cord inside the left molded channel cord holder.

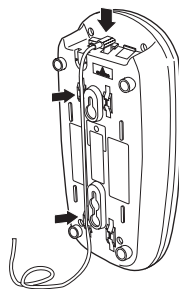

- 4) Plug one end of the long telephone cord into the **TEL LINE** jack on the back of the base and place the telephone cord into the right molded channel cord holder.

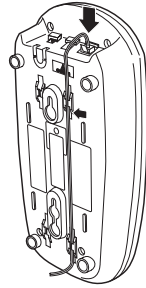

- 5) Place the base on the screws and push it downward to secure.

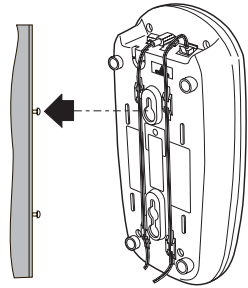

- 6) Plug the other end of the telephone cord into the wall jack.

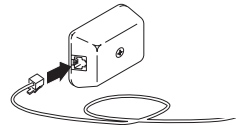

- 7) Plug the AC adapter into a standard 120 V AC wall outlet that is not controlled by a wall switch.

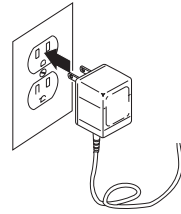

- 8) Raise the antenna on the base.

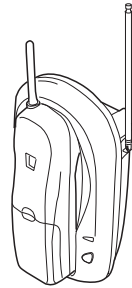

INSTALLING THE HANDSET BATTERY PACK

- 1) Remove the handset battery cover by pressing in on the cover release and sliding it downward.

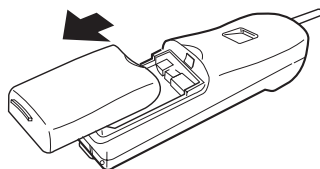

- 2) Plug the battery's cable into the handset.

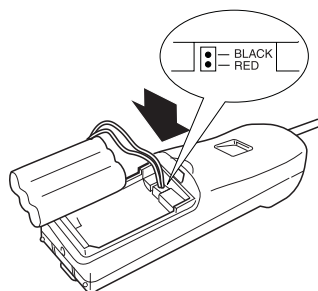

- 3) Slide the battery cover on until it snaps into place.

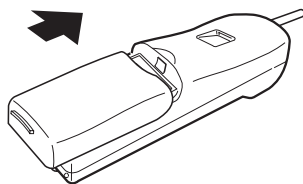

Use only the Uniden battery (BT-905) supplied with your phone.

CHARGING THE BATTERY PACK

▼ *Initial battery charging*

Before plugging the phone line into your new phone for the first time, fully charge the rechargeable battery pack for 15-20 hours *without interruption*.

- 1) Place the handset on the base.
- 2) Make sure that **status** LED lights. If the LED doesn't light, check to see that the AC adapter is plugged in and that the handset makes good contact with the base charging contacts.

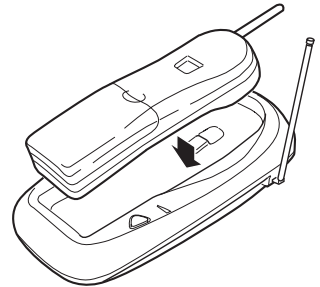

▼ *Low battery indicator*

When the battery pack is very low and needs to be charged, the phone is programmed to eliminate functions in order to save power. The handset beeps. Complete your conversation as quickly as possible and return the handset to the base for charging.

CLEANING THE BATTERY CONTACTS

To maintain a good charge, clean all charging contacts on the handset and base about once a month with a pencil eraser or other contact cleaner. DO NOT use liquids or solvents; you may damage your phone.

TIP

Most phone systems use tone dialing. Check with your local phone company if you're not sure whether your system is tone or pulse.

SETTING THE PULSE/TONE SWITCH

Be sure the **PULSE/TONE** switch is in the **TONE** position unless your local phone system uses pulse dialing.

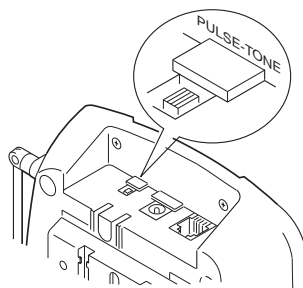

ADJUSTING THE RINGER AND VOLUME CONTROLS

▼ Handset Ringer Tone and Volume

Your EXI 6960 lets you choose from two ringer tones, Type A and Type B. Each tone has a low and high volume setting. When the phone is in standby mode, press the **vol ▲** or **▼** key on the handset to select the handset ringer tone and volume. As you change the settings, the selection appears on the LCD.

Ring Type B
High

▼ Handset Earpiece Volume

The EXI 6960 comes with four volume settings for the handset earpiece - normal, medium, high and loud.

During a call, press **vol ▲** to increase the earpiece volume, press **vol ▼** to decrease the earpiece volume. As you increase or decrease the volume, your selection appears on the LCD.

Talk 0:15
<High>

NOTE

You can only adjust the earpiece volume setting during a call.

When you hang up, the EXI 6960 keeps the last volume setting selected.

NOTE

When an incoming call is received during paging, paging is stopped and the telephone is switched to the incoming call.

USING THE PAGE FEATURE

- 1) To locate the handset when it is not on the base, press and release the **page/find** key.

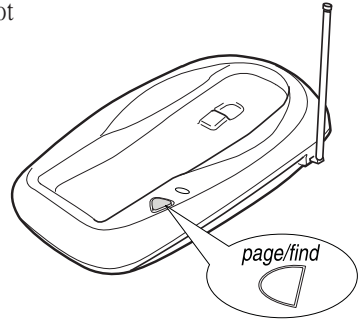

- 2) The handset beeps for 60 seconds and the following screen appears:

Paging

- 3) Once you have found the handset, press any key to end the page.

AUTOMATIC DIGITAL CODE SECURITY

To prevent other parties from making unauthorized calls on your phone line, a digital code was added to the EXI 6960. Your phone's handset and base share this code, which is randomly set each time you place the handset in the charging cradle.

To reestablish communication between the handset and the base in the event of a power failure:

- 1) Restore power to the base.
- 2) Place the handset in the base and press **page/find**.
- 3) Pick up the handset from the base.
- 4) Return the handset to the base.

The **status** LED blinks to indicate that the digital security code is reset.

MAKING AND RECEIVING CALLS

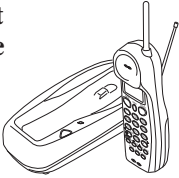
	Handset On Base 	Handset Off Base 
To answer a call	Pick up the handset (AutoTalk) or press talk .	Press any button (Autotalk) or press talk .
To make a call	1) Pick up the handset. 2) Press talk . 3) Listen for the dial tone. 4) Dial the number. OR 1) Pick up the handset. 2) Dial the number, then press talk .	1) Press talk . 2) Listen for the dial tone. 3) Dial the number. OR Dial the number, then press talk .
To hang up	Press talk , or return the handset to the base (AutoStandby).	
To redial	1) Pick up the handset. 2) Press talk . 3) Listen for the dial tone. 4) Press redial .	1) Press talk . 2) Listen for the dial tone. 3) Press redial .

FLASH AND CALL WAITING

If you have “call waiting” service and a call waiting tone sounds while you are on a call, press **flash** to accept the waiting call. There is a short pause, then you will hear the new caller. To return to the original caller, press **flash** again.

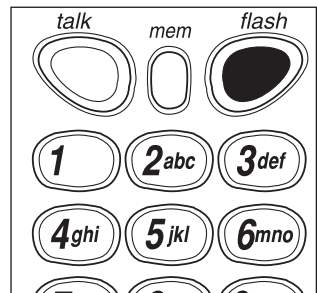

STORING A PHONE NUMBER IN MEMORY

NOTE

Whenever you are using a menu screen, you must press a key within 20 seconds or the phone will return to standby. You may also press **mem** to exit a memory menu at any time.

HINT

The character menu consists of letters, symbols, and numbers.

NOTE

The pause button counts as one digit. Pressing **pause** more than once increases the length of pause between numbers.

NOTE

*When entering numbers, press **pause** to enter a pause in the dialing sequence. The display shows a P. The pause feature is useful for long distance calling, credit card dialing, or sequences requiring pause between digits.*

- 1) Remove the handset from the base.
- 2) Press and hold **mem** for two seconds. A short tone will sound and the following screen appears.
- 3) Use the ▲ and ▼ keys or number keypad to choose the memory location where you would like to enter a number.

```
Memory Store
1▶
2
```

- 4) Press **select**. The following screen appears, and a cursor flashes indicating that the display is ready for the name to be entered.
- 5) Use the ▲ and ▼ keys to scroll through the character menu. Use the ◀ and ▶ keys to move the cursor to the desired location, and enter the name.
- 6) If you make a mistake, press **delete** to erase the character you just entered. Or press and hold **delete** to erase the entire line.

```
Store Name
█
```

- 7) Press **select**. The following screen appears, and a cursor flashes indicating that the display is ready for the number.

```
Store Number
█
```

- 8) Enter the phone number with the handset keypad.

- 9) Press **select**. The handset beeps and displays a confirmation screen. For example, if you store a name and number into memory location number one, the display shows Memory 1 Stored.

```
Memory 1 Stored
```

- 10) Press **mem** or return the handset to the charging cradle to exit store mode. Or, wait 20 seconds for the phone to return to standby.

NOTE

Whenever you are using a menu screen, you must press a key within 20 seconds or the phone will return to standby. You may also press **mem** to exit a memory menu at any time.

NOTE

If you select **Go Back** at any time, no changes are made and the handset shows the Memory Store screen.

EDITING A PHONE NUMBER IN MEMORY

Follow these steps to edit a phone number that you have already programmed into memory.

- 1) Remove the handset from the base.
- 2) Press and hold **mem** for two seconds. The display shows the Memory Store screen and any saved numbers.

Memory Store
1 ► KAYSIE SCHLITZ
2 UNIDEN
- 3) Use the ▲ and ▼ keys or number keypad to select the memory location you would like to edit. The ◀ and ▶ keys toggle between the names display and the numbers display.
- 4) Press **select**. The following screen appears with the memory location number that you have selected in the display.

► Edit Memory 1
Delete Memory 1
Go Back

NOTE

*You may move the ► cursor down to Go Back and press **select** if you would like to exit this menu.*

- 5) With ► cursor next to **Edit Memory**, press **select**. The following screen appears, and a cursor flashes indicating that the display is ready for the name to be edited.

Store Name
KAYSIE SCHLITZ
- 6) Use the ▲ and ▼ keys to scroll through the character menu. Use the ◀ and ▶ keys to move the cursor to the desired location, and enter the name.
- 7) Press **select**. The following screen appears, and a cursor flashes indicating that the display is ready for the number to be edited.

Store Number
8175551212
- 8) Enter the phone number with the number keypad.

- 9) Press **select**. The handset beeps and displays a confirmation screen. For example, if you store a name and number into memory location number one, then the handset shows **Memory 1 Stored**.

Memory 1 Stored

- 10) The display then returns to the Memory Store screen. You may select another number to edit (return to step 3) or you may press **mem** to return to standby.

ERASING A NUMBER FROM MEMORY

Use these steps to erase a programmed number from memory. Once a number is erased, that memory location may be programmed with a new number.

- 1) Remove the handset from the base.

- 2) Press and hold **mem** for two seconds. The handset shows the Memory Store screen with any saved numbers displayed.

Memory Store
1 ► KAYSIE SCHLITZ
2 UNIDEN

- 3) Use the ▲ and ▼ keys or number keypad to select the memory location you would like to delete. The ◀ and ▶ keys toggle between the names display and the numbers display.

- 4) Press **select**. The following screen appears with the memory location number that you have selected in the display.

► Edit Memory 1
Delete Memory 1
Go Back

- 5) Use the ▼ key to move the ► cursor down to the **Delete Memory** command.

Edit Memory 1
► Delete Memory 1
Go Back

- 6) Press **select**. The following confirmation screen appears.

Delete Memory?
Yes
► No

- 7) Use the ▲ key to move the ► cursor to the **Yes** command.

NOTE

If you select **Go Back** at any time, no changes are made and the handset shows the Memory Store screen.

NOTE

If you select **No**, no changes are made and the handset shows the Memory Store screen.

HINT

Use the ◀ and ▶ keys to toggle between the names and the numbers displayed in memory.

- 8) Press **select**. There is a confirmation tone, and the handset displays **Memory 1 Deleted**.

Memory 1 Deleted

- 9) The display then returns to the Memory Store screen. You may select another number to delete (return to step 3) or you may press **mem** to return to standby.

USING MEMORY DIALING

Follow the steps below to dial a number using a programmed memory location.

- 1) Press **mem**. The handset displays your programmed memory locations.

1 ▶ KAYSIE SCHLITZ
2 Uniden
3 Grandma

- 2) Use the ▲ and ▼ keys or the number keypad to select the memory location you would like to dial.

1 KAYSIE SCHLITZ
2 ▶ Uniden
3 Grandma

- 3) Press **talk** and the number dials.

NOTE

*If you already know the memory location of the number you wish to dial, press **talk** then **mem** and the memory location. The phone will automatically dial the number.*

CHAIN DIALING

On certain occasions after dialing a number, you may be requested to enter an access code, such as your account number. You can enter this number into a memory location for later use by doing the following.

- 1) Store the access code into one of the memory locations (0-9). See “Storing A Phone Number in Memory” (page 16).
- 2) Dial the party or service main number.

- 3) When you need to enter the special number, press **mem** followed by the memory location (0-9).

USING CALLER ID

You must subscribe to Caller ID from your phone company in order to use this feature.

▼ *Setting Up Caller ID Options*

There are three Caller ID setup options available; Autotalk, CIDCW, and Area Code.

Auto Talk allows you to answer the phone without pressing the **talk** button. If the phone rings when Autotalk is on, simply remove the handset from the cradle and the phone automatically answers the call. If the phone rings when Autotalk is off, you must press **talk** to answer the call. This option is useful to help you screen your calls more effectively.

CIDCW (Caller ID on Call Waiting) performs the same as regular Caller ID on a call waiting number. **You must subscribe to CIDCW from your phone company in order to use this feature.**

If you enter your 3-digit area code number in the **Area Code** option, your local area code does not appear in Caller ID messages. When reviewing Caller ID messages, you will see only the local seven digit number. For calls received from outside your local area code, you will see a full 10-digit number.

NOTE

You must subscribe to CIDCW from your phone company in order to use this feature.

NOTE

If your calling area requires 10-digit dialing, do not program this option.

HINT

You may use the ◀ and ▶ keys to toggle between numbers when programming the area code.

To change your Caller ID options:

- 1) Press and hold **call id** for two seconds. A short tone will sound and the following screen appears.

```
1▶Auto Talk :Off
2 CIDCW      :On
3 Area Code :
```

- 2) Use the ▲ and ▼ keys to move the cursor to the selection that you would like to change. Press the **select** key to toggle between **On** and **Off** for **Autotalk** and **CIDCW**. Press **select** and use the number keypad to enter or change the area code, then press **select** again. (You hear a confirmation tone indicating the area code has been changed.)
- 3) After you have made your selections, press **call id** and return the handset to the base. The **status** LED flashes, indicating that your setup changes are now effective.

▼ *Screening Your Calls*

Caller ID allows you to review caller information before you answer your phone. When the phone rings, the display shows the date, time, call count, name, and phone number of the caller. If your Caller ID service is number only, then the name does not appear on the second line.

```
12/21 12:30PM 03
Schlitz Kaysie
817-555-1212
```

If a name or number is not available, the display will show a message such as **Incomplete Data**, **Private Number**, **Private Name**, etc.

▼ *Using CIDCW (Caller ID on Call Waiting)*

- 1) During a call when you hear the Call Waiting tone, check the handset for the name and number of the incoming caller.
- 2) Press **flash** to accept the incoming call. See page 15 for additional information.

```
Talk      0:00
Schlitz Kaysie
817-555-1212
```

NOTE

If you have no New Caller ID Messages, then the "New" display is blank. Only the "Total" display appears.

NOTE

Once a Caller ID message has been viewed, it is no longer considered a new message.

NOTE

If you have no Caller ID messages, then the total is shown as 00.

NOTE

Your phone stores the most recent 30 numbers in Caller ID memory. If the memory is full, a new call replaces the oldest number.

HINT

For long distance dialing, press **1** to add a 1 to the number in the display.

▼ Reviewing Caller ID Numbers

Your phone stores the most recent 30 numbers in Caller ID memory. If the memory is full, a new call replaces the oldest number. To review your Caller ID numbers, follow the steps below.

- 1) Press **call id**, and the Caller ID summary screen appears. The screen shows the number of new callers and the total number of callers stored in Caller ID memory. (This screen appears on the display whenever the handset is face up in the base.)
- 2) Press ▼ to scan through the list. The most recent call appears first, with the date, time, call count, name, and phone number. Press ▲ to scan back through the list.
- 3) Once you have reviewed your oldest call, the following screen appears. Press **call id** to return to standby.

```
New : 01
Total : 02
```

```
12/21 12:30PM 03
Schlitz Kaysie
817-555-1212
```

```
End
```

NOTE

Once you have viewed all of your Caller ID numbers and reached the "End" display, the list does not cycle back to the beginning. You must press ▲ to view your previous calls.

▼ Calling a Caller ID Number

- 1) Press **call id**, and the Caller ID summary screen appears. The screen shows the number of new callers and the total number of callers stored in Caller ID memory.
- 2) Select the number that you would like to dial. Press ▼ to scan forward and ▲ to scan back through the list.
- 3) Press **talk** and the number automatically dials.

```
New : 01
Total : 02
```

```
12/21 12:30PM 03
Schlitz Kaysie
817-555-1212
```

▼ Storing a Caller ID Number Into a Memory Location

- 1) Press **call id**, and the Caller ID summary screen appears. The screen shows the number of new callers and the total number of callers stored in Caller ID memory.
- 2) Press ▼ or ▲ to find the number that you would like to store, then press **mem** to store the selection.
- 3) The select location screen appears. Use the ▲ and ▼ keys to select a blank memory location where you would like to store the number. (If you want to replace an existing number with the Caller ID number, skip to step 5.)
- 4) Press **select**. A confirmation tone sounds, and the number is programmed. (Do not complete steps 5 and 6.)
- 5) If you choose to replace an existing number with the Caller ID number, press **select**, and the following screen appears.
- 6) Use the ▲ key to move the cursor to **Yes** and press **select**. A confirmation tone sounds, and the number is programmed.

```
New : 01
Total : 02
```

```
12/21 12:30PM 03
Schlitz Kaysie
817-555-1212
```

```
Select Location
1▶ KAYSIE SCHLITZ
2 UNIDEN
```

```
Replace Memory?
Yes
▶ No
```

NOTE

If you select **No**, then the Caller ID screen returns.

HINT

The ◀ and ▶ keys to toggle between the names display and the numbers display.

▼ Deleting a Caller ID Number

To delete a single Caller ID message, follow the steps below.

- 1) Press **call id**, and the Caller ID summary screen appears. The screen shows the number of new callers and the total number of callers stored in Caller ID memory.
- 2) Select the number that you would like to delete. Press ▼ to scan forward and ▲ to scan backwards through the list.

```
New : 01
Total : 02
```

```
12/21 12:30P 03
Schlitz Kaysie
817-555-1212
```

- 3) Press **delete**, and the following screen appears.

```
Delete Message?  
▶ Yes  
No
```

- 4) Press **select** or **delete**. A confirmation tone sounds and the Caller ID screen returns with the next message displayed.
- 5) After you have deleted the Caller ID number, the display shows **End**. Press **call id** to return to standby.

```
End
```

▼ *Deleting All Caller ID Numbers*

To delete all of your Caller ID numbers, follow the steps below.

- 1) Press **call id**, and the Caller ID summary screen appears. The screen shows the number of new callers and the total number of callers stored in Caller ID memory.

```
New : 01  
Total : 02
```

- 2) Press **delete**, and the following screen appears.

```
Delete All?  
Yes  
▶ No
```

- 3) Use the ▲ key to move the cursor to **Yes**, then press **select** or **delete**.

- 4) A confirmation tone sounds, and the following screen appears.

```
Total:00
```

- 5) Press **call id** to return to standby.

USING REDIAL

Press **redial/p** to call the last number dialed. The number redialed can be up to 32 digits long.

If you press **redial/p** before pressing the **talk** key, you can edit the number using the **delete** key.

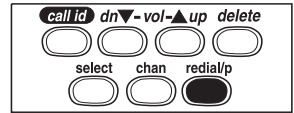

USING THE TONE FEATURE

If you are dialing in the pulse mode and need to enter tone digits, press **tone** to enter the digits. Once the call has ended, the tone mode is canceled and pulse dialing resumes. The tone feature applies only when the base unit is set to pulse.

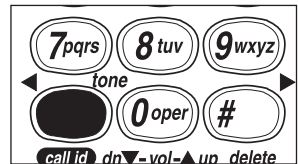

SELECTING A DIFFERENT CHANNEL

If you encounter interference while using your phone, you can manually change the channel for clearer operation. This function works only when the phone is in use.

The **chan** button on the handset allows you to choose between 40 channels. During the course of a conversation, if you hear static or noise which makes it difficult to hear, press **chan**. The following screen appears and the phone changes to a different channel.

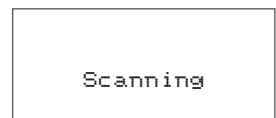
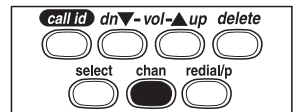

TRAVELING OUT-OF-RANGE

During a call, as you begin to move too far from your base unit, noise increases. If you pass the range limits of the base unit, your call will terminate within 20 seconds.

QUICK REFERENCE CHART

If your phone is not performing to your expectations, please try these simple steps. If you are still unable to resolve the problem, contact your place of purchase or call customer service at (800)297-1023.

PROBLEM	SUGGESTION
<p><i>The charge light won't come on when the handset is placed in the base.</i></p>	<ul style="list-style-type: none"> • Make sure the AC adapter is plugged into the base and wall outlet. • Make sure the handset is properly seated in base. • Make sure the charging contacts on the handset and base are clean.
<p><i>The audio sounds weak and/or scratchy.</i></p>	<ul style="list-style-type: none"> • Make sure that the base antenna is in a vertical position. • Press chan to help eliminate background noise. • Move the handset and/or base to a different location away from metal objects or appliances and try again.
<p><i>Can't make or receive calls.</i></p>	<ul style="list-style-type: none"> • Check both ends of the base telephone line cord. • Make sure the AC adapter is plugged into the base and wall outlet. • Disconnect the AC adapter for a few minutes, then reconnect it. • Reset security code (see page 14).

PROBLEM	SUGGESTION
<i>The handset doesn't ring or receive a page.</i>	<ul style="list-style-type: none">• The Nickel-Cadmium battery pack may be weak. Charge the battery on the base unit for 15-20 hours.• The handset may be too far away from the base unit.• Place the base unit away from appliances or metal objects.• Reset security code (see page 14).

GENERAL

The EXI 6960 complies with FCC Parts 15 and 68.

Frequency control: PLL

Modulation: DBPSK

Operating temperature: -10^o to 50^o C (+14^o F to +122^o F)

BASE

Frequency: 925.997 to 927.947 MHz (40 channels)

Power requirements: 9 V 210 mA, or 9V 180mA (from AC adapter)

Size: 4-3/8 in. (W) x 2-1/4 in. (D) x 8-1/2 in. (H)

Weight: Approx. 11.1 oz.

HANDSET

Frequency: 902.052 to 904.002 MHz (40 channels)

Power requirements: Rechargeable Nickel-Cadmium battery pack

Size (without antenna): 2-1/8 in. (W) x 1-1/2 in. (D) x 7 in. (H)

Weight: Approx. 8.6 oz. (including battery)

Battery: BT-905

Capacity 600 mAH, 3.6V

Talk mode 7 hours

Standby mode 14 days

Specifications, features, and availability of optional accessories are all subject to change without prior notice.

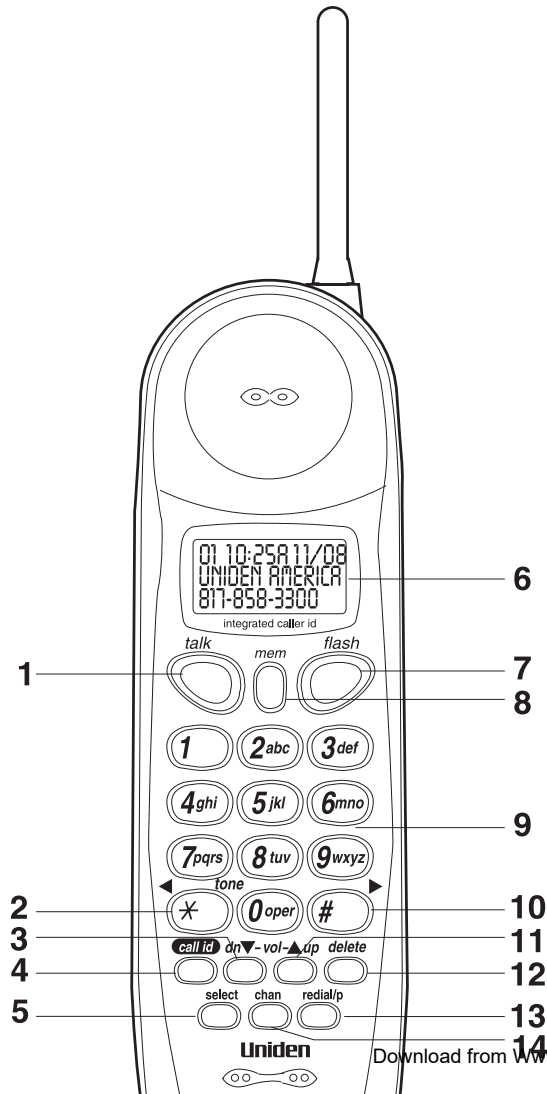

1. Talk
2. Tone/Left Cursor
3. Volume Down
4. Caller ID
5. Select
6. Handset Display
7. Flash
8. Memory
9. Keypad
10. Right Cursor

11. Volume Up
12. Delete
13. Redial/Pause
14. Channel
15. Page/Find
16. Status LED
17. Handset Retainer Clip
18. Pulse/Tone
19. DC Input Jack
20. Tel Line

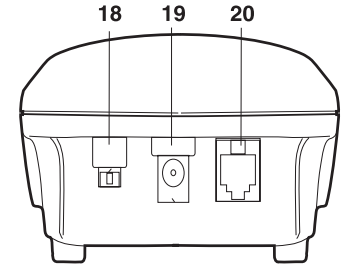
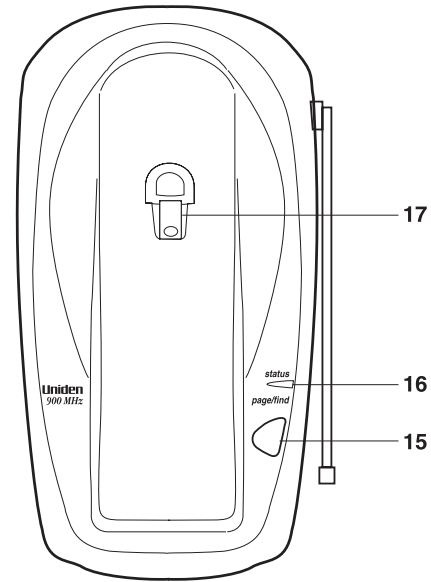

Free Manuals Download Website

<http://myh66.com>

<http://usermanuals.us>

<http://www.somanuals.com>

<http://www.4manuals.cc>

<http://www.manual-lib.com>

<http://www.404manual.com>

<http://www.luxmanual.com>

<http://aubethermostatmanual.com>

Golf course search by state

<http://golfingnear.com>

Email search by domain

<http://emailbydomain.com>

Auto manuals search

<http://auto.somanuals.com>

TV manuals search

<http://tv.somanuals.com>