



E X L A 8 9 5 0

# OWNER'S MANUAL

900 MHz Cordless  
Phone with Digital  
Answering System

Long Distance  
Manager

3-Way Conference  
Operation

**Uniden®**

# INTRODUCTION

TO YOUR NEW PHONE

## Introduction

Thank you for choosing the Uniden EXLA 8950 cordless telephone. This phone is designed to exacting standards that provide reliability, long life and outstanding performance.

**Note: Some illustrations in this manual may differ from the actual unit for explanation purposes.**

## Features

- 900 MHz Extended range
- Secure Digital Transmission
- Integrated Answering Device
- Long Distance Manager
- 10 Number Memory
- 32 Digit Redial
- Flash
- Pause
- Pulse / Tone Dialing
- 7 Day Standby Battery Life
- 7 Hour Talk Time
- Handset Earpiece and Ringer Volume Control
- Speakerphone
- 3-Way Conference Operation
- Intercom

# Controls and functions

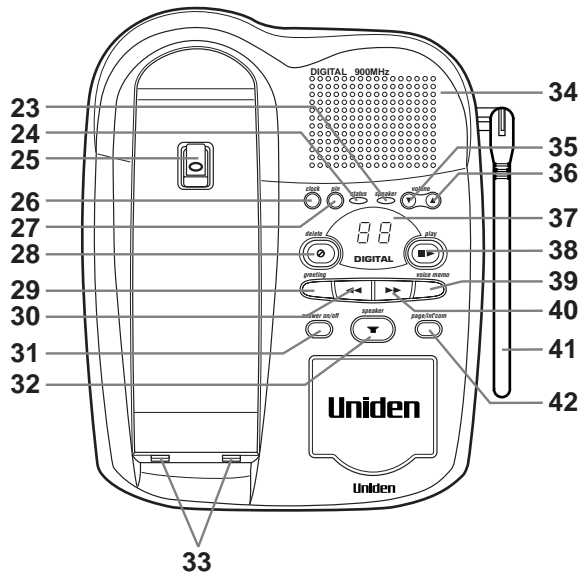
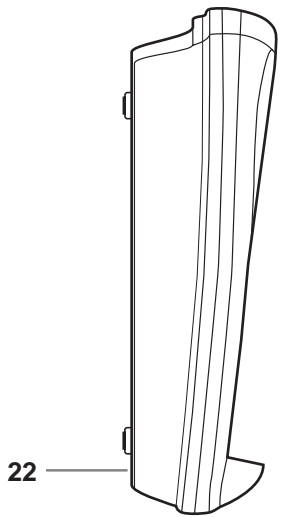
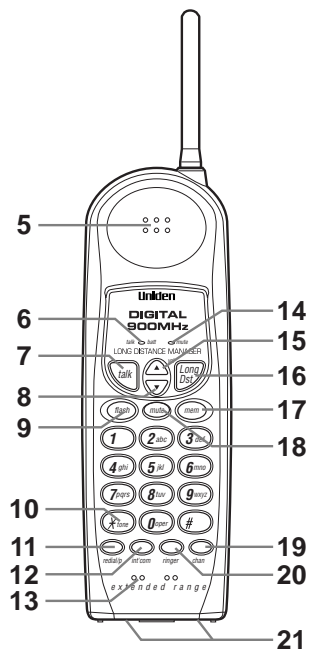
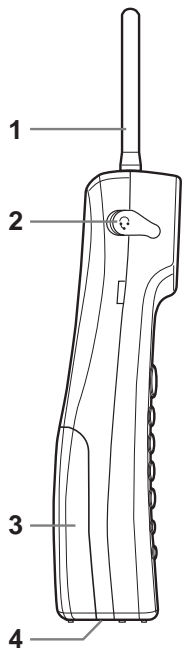

1. Handset antenna
2. Headset jack cover
3. Handset battery compartment
4. Handset ring switch
5. Handset earpiece
6. Talk/Battery LED
7. Talk key
8. Volume down key
9. Flash key
10. Tone key
11. Redial/Pause key
12. Intercom key
13. Handset microphone
14. Mute LED
15. Volume up key
16. Long Distance Manager key
17. Memory key
18. Mute key
19. Channel key
20. Ringer select key
21. Handset charging contact
22. Base microphone
23. Speaker LED
24. Status LED
25. Handset retainer clip storage
26. Clock key
27. Pin key
28. Delete key
29. Greeting key
30. Repeat key
31. Answer on/off key
32. Speaker key
33. Base charging contact
34. Base speaker
35. Volume down key
36. Volume up key
37. LED display
38. Play/Stop key
39. Voice memo key
40. Skip key
41. Base antenna
42. Page/Intercom key
43. Record time switch
44. Ring time switch
45. Ring volume switch
46. Pulse-Tone switch
47. DC power input
48. Phone jack

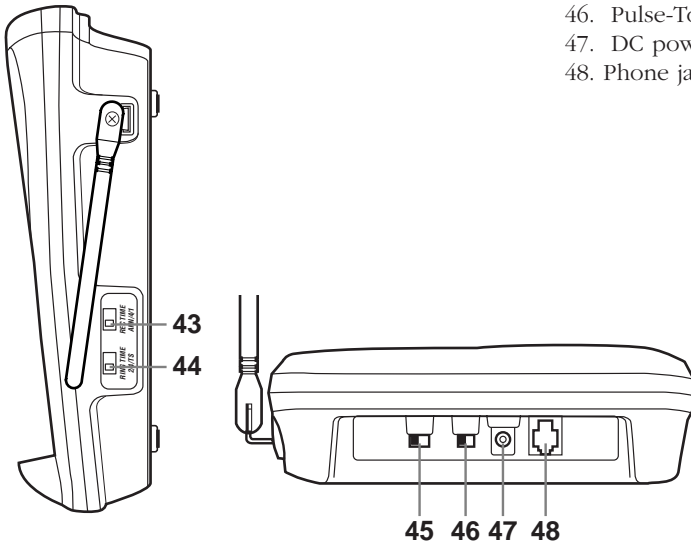

# CONTENTS

## OF YOUR OWNER'S MANUAL

### Contents

Introduction / Features.....	inside front cover
Control and Functions.....	inside front cover

#### Getting Started

Read this first.....	3
Step 1: Checking the package contents.....	4
Step 2: Setting up the base unit .....	5
Mounting the base unit on a wall .....	8
Step 3: Preparing the battery pack.....	10

#### Basics

Making a call .....	12
LDM (Long Distance Manager) .....	13
Receiving a call .....	15
Adjusting ringer and earpiece volume.....	16
Redialing a call .....	17
Using the speakerphone.....	17
Mute .....	18

#### Memory Dialing

Storing phone numbers .....	19
Making calls with memory dialing.....	20
Erasing a stored phone number.....	21

#### 3-way Conference Features

3-way conferencing.....	22
Using your EXLA 8950 intercom .....	23
Transferring a call.....	24

#### The Integrated Answering Device

Features.....	25
Setting up your answering system .....	26
Using your answering system .....	30

#### Additional Information

Changing the digital security code.....	36
Installing the beltclip.....	37
Headset installation .....	37
Note on power sources .....	38
Maintenance.....	38

<b>Troubleshooting</b> .....	39
------------------------------	----

<b>Specifications</b> .....	41
-----------------------------	----

<b>Index</b> .....	42
--------------------	----

Getting Started

Basics

Memory Dialing

3-way  
Conference  
Features

The Integrated  
Answering  
Device

Additional  
Information

**Read this first**

This cordless telephone must be set up before use. Follow these steps;

**Step 1** (page 4)

Unpack the telephone and accessories.

**Step 2** (page 5 to 9)

Next, choose the best location to set up the base unit.

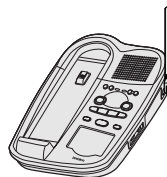

**Base unit**

**Step 3** (page 10 to 11)

Then, insert the battery pack into the handset. You have to charge the battery pack for more than 12-15 hours before using the phone.



**Handset**

**About the digital security code**

This cordless telephone uses a digital security code to prevent unauthorized access to your base unit. This security code prevents other cordless handsets from making calls through your base unit. A random security code will be assigned automatically between your base unit and handset when you charge the battery pack for the first time.

If you want to reset the security code, see page 36.

## Checking the package contents

Make sure you have received the following items in the package. If any of these items are missing or damaged, contact the **Uniden Parts Department** (see below).



• Base unit



• Handset

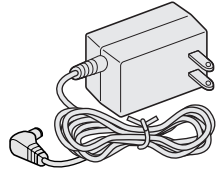

• AC adapter (AD-420)

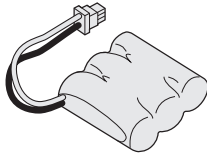

• Rechargeable battery pack (BT-905)

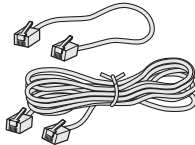

• Telephone line cord (2)

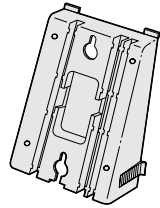

• Wall mount adapter

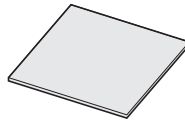

• Memo sticker

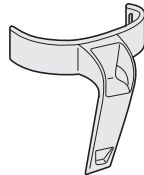

• Beltclip

- This Owner's Manual
- Precautions and Important Safety Instructions
- Registration Card

### Uniden Parts Department

(800) 554-3988

Hours: M-F 8:30 AM to 5:00 PM CST.

We can also be reached on the web at [www.uniden.com](http://www.uniden.com).

## Setting up the base unit

Do the following steps.

- Choose the best location
- Connect the base unit
- Choose the dialing mode

### Choose the best location

Before choosing a location for your new phone, read the **INSTALLATION CONSIDERATIONS** included in the **PRECAUTIONS AND IMPORTANT SAFETY INSTRUCTIONS** brochure. Here are some important guidelines you should consider:

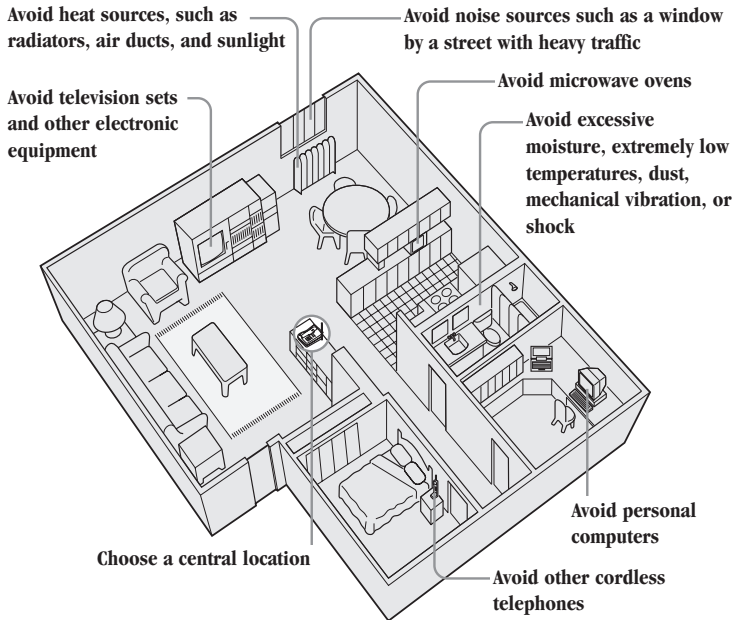

- You should charge your handset for 12-15 hours before using the phone.
- The location should be close to both a phone jack and continuous a power outlet which is not switchable.
- Keep the base and handset away from sources of electrical noise such as motors and fluorescent lighting.
- Be sure there is sufficient space to raise the base antenna fully vertical.
- The base can be placed on a desk, tabletop or mounted on a standard wall plate.



## Connect the base unit

If you want to install the base unit on the wall, see page 8.

### NOTE

Place the power cord so it does not create a trip hazard, or where it could become chafed and create a fire or electrical hazard.

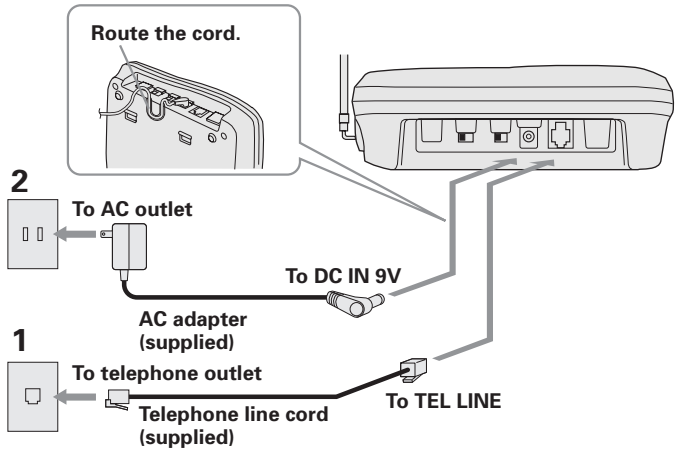

- 1** Connect the telephone line cord to the **TEL LINE** jack and to a telephone outlet.
- 2** Connect the AC adapter to the **DC IN 9V** jack and to a standard 120VAC wall outlet.
- 3** Set the base unit on a desk or tabletop and place the handset on the base unit. Then raise the antenna to a vertical position.

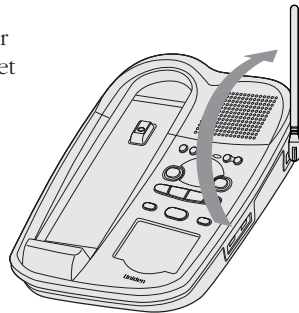



Use only the supplied AD-420 AC adapter. Do not use any other AC adapter.

**Polarity of the plug**

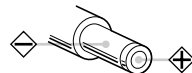

Connect the AC adapter to a continuous power supply.



If your telephone outlet isn't modular, contact your telephone company for assistance.

**Modular**



## Choose the dialing mode

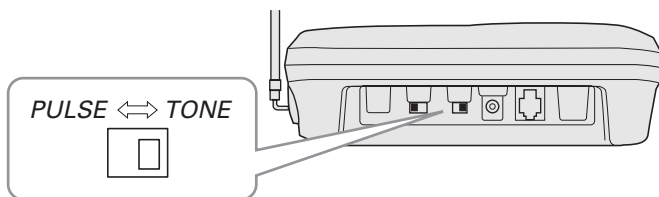

Depending on your dialing system, set the **TONE/PULSE** switch as follows:

If your dialing system is	Set the switch to
Tone	<b><i>TONE</i></b>
Pulse	<b><i>PULSE</i></b>

### If you aren't sure of your dialing system

Make a trial call with the **TONE/PULSE** switch set to ***TONE***.

If the call connects, leave the switch as is; otherwise, set to ***PULSE***.

## Mounting the base unit on a wall

### Standard wall plate mounting

This phone can be mounted on any standard telephone wall plate.

1

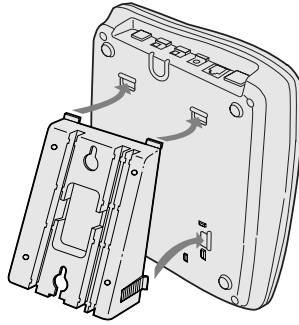

1

Snap the wall mount adapter into the notches on the base.

2

Plug the telephone line cord to the **TEL LINE** jack and the AC adapter to the **DC IN 9V** jack.

3

Plug the telephone line cord into the telephone outlet.

4

Wrap the AC adapter cord inside the molded wiring channel. Then wrap the cord around the strain relief notch.

5

Plug the AC adapter into a standard 120V AC wall outlet.

6

Raise the antenna to a vertical position.

7

Align the mounting slots on the base with the mounting posts on the wall. Push in and down until the phone is firmly seated.

2 - 7

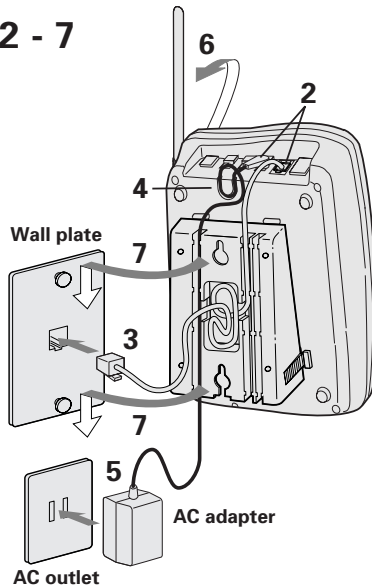

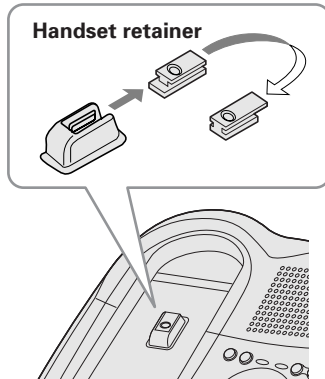

**8** On the base unit, pull the handset retainer out of the slot. Rotate it clockwise 180 degrees.

**9** Flip the retainer from front to back. Slide it back into the slot so that the lip of the retainer is up and the oval is down. The retainer holds the handset in place.

## Direct wall plate mounting

If you don't have a standard wall plate, you can mount your phone directly to the wall. Before doing this, consider the following:

- Avoid electrical cables, pipes, or other items behind the mounting location. That could cause a hazard when inserting screws into the wall.
- Try to mount your phone within 10 - 15 feet of a working phone jack to avoid excessive cord lengths.
- Make sure the wall material is capable of supporting the weight of the base and handset.

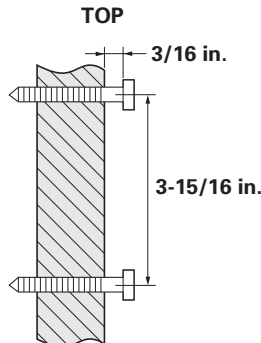

**1** Insert two mounting screws into the wall, (with their appropriate anchoring device), 3-15/16 inches apart. Allow about 3/16 of an inch between the wall and screwheads for mounting the phone.

**2** Refer to steps 1 through 9 on pages 8 and 9 to mount the telephone.

## Preparing the battery pack

Charge the battery pack for more than 12-15 hours before you start using your phone.

### NOTE

Use only Uniden Battery BT-905.

**1** Press the battery cover release.

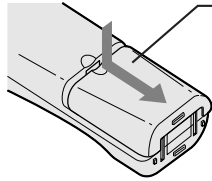

**2** Connect the battery pack connector with the correct polarity (black and red wires), then insert the battery pack into the battery compartment.

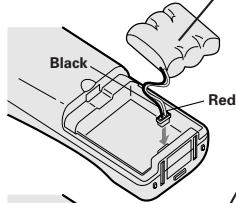

**3** Slide the battery cover forward until it snaps into place.

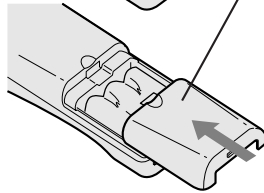

**4** Place the handset on the base. Make sure that the "**status**" LED of the base unit lights, and charging begins. Charge the battery for at least 12-15 hours. You can place either side up for charging the battery.

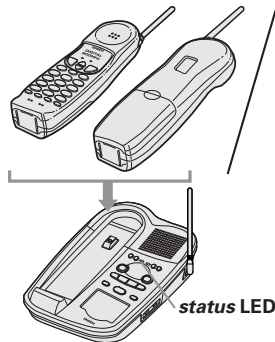



**NOTE**

Even when the battery pack is not being used, it will gradually discharge over a long period. For optimum performance, be sure to return the handset to the base unit after a telephone call for charging the battery.



**NOTE**

The built-in memory backup can hold numbers and names stored in the memory for up to 2 minutes, while you replace the battery pack.



**NOTE**

If you must replace the battery pack during a telephone call, complete the replacement of the battery pack within 30 seconds, and you can return to the original call.



**NOTE**

Rechargeable batteries have a memory effect that reduces standby and talk time. To avoid this memory effect, on a monthly basis, use the phone until the **batt** LED blinks. Then charge the battery for 12-15 hours.

## Battery use time (per charge)

From fully charged

- Seven hours continuous use.
- Seven days when the handset is in the standby mode.

## When the battery charge becomes low

When the voltage of battery pack in the handset is very low and needs to be charged, the phone is programmed to eliminate functions in order to save power. If the battery charge becomes low Battery lamp blinks. If the phone is in use, the handset beeps. Complete your conversation as quickly as possible and return the handset to the base unit for charging.

## Cleaning the battery contacts

To maintain a good charge, it is important to clean all battery contacts on the handset and base unit about once a month. Use a pencil eraser or other contact cleaner.

**Do not use any liquids or solvents.**

## NOTE

The phone number can be up to 32 digits.

## Making a call



### From the handset

- 1 Pick up handset.
- 2 Press **(talk)**. The “**talk/batt**” LED blinks.
- 3 Dial the phone number.
- 4 To hang up, press **(talk)** or return the handset to the base.

### Other Operations

To	Do this
To improve reception	Press <b>(chan)</b> .
To adjust the earpiecer volume	Press <b>(▲)</b> or <b>(▼)</b> during the call.
To temporarily switch to tone dial (When base is set to pulse mode)	Press <b>(* tone)</b> . The following numbers dialed will be sent as tone dialing.
To enter a pause within the numbers dialed	Press <b>(redial/p)</b> .
To use Call Waiting service	Press <b>(flash)</b> when a new call comes in during a conversation.

## LDM (Long Distance Manager)

### Sign up and Registration

1. Before using the LDM feature, you must register your phone by calling 1-800-458-2682.
2. You will be asked a few simple questions, such as name, address, and phone number.
3. Each month you will receive an itemized bill for calls placed through the LDM service.

### Placing a call using LDM

Press **(LongDst)** key before dialing a long distance (1+) or international (011+) number.

### LDM call from the handset



- 1** Pick up your phone.
- 2** Press **(LongDst)**. The “**talk/batt**” LED blinks.
- 3** Enter the long distance phone number. You must dial a “1” or “011” when using the LDM feature.
- 4** To complete, press **(talk)** or return the handset on the base.



## Private Branch Exchange (PBX) dialing

### NOTE

Redial will not function when using the LDM through a PBX.

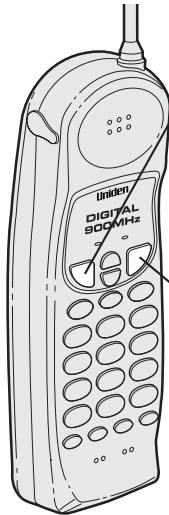

### From the handset

- 1 Press **(talk)** .
- 2 Dial out by entering 9 on the keypad, or any sequence of numbers required to access an outside line.
- 3 Listen for dial tone. Then press **(LongDst)** key followed by a long distance or international number. The call will be placed using the LDM service.
- 4 To complete, press **(talk)** or return the handset on the base.

### NOTES

- You must dial a "1" or "011" when using the LDM feature.
- **Do NOT USE **(LongDst)** BUTTON TO DIAL 911 BECAUSE IT WILL NOT ACCESS EMERGENCY SERVICE.**
- Do not use the **(LongDst)** key for placing local calls, contacting your local phone company for repair or customer service, accessing emergency service or for toll free numbers.
- All calls placed through the LDM feature will be charged at the applicable toll rate for the specific call.
- Failure to register will result in lost savings.

## Receiving a call

### From the handset

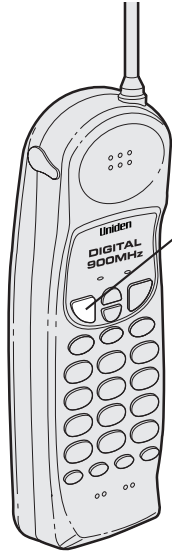

#### Handset on the base

- 1 Phone rings. The **"talk/batt"** LED flashes.
- 2 Pick up the handset and speak.
- 3 Press **(talk)** or return the handset to the base to finish the call.

#### Handset off the base

- 1 Phone rings. The **"talk/batt"** LED flashes.
- 2 Press any key (except **(mute)**) and speak.
- 3 Press **(talk)** or return the handset to the base to finish the call.

### From the base

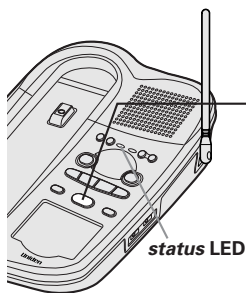

- 1 The phone rings. The **status** LED on the base flashes.
- 2 Press **(speaker)**.
- 3 Press **(speaker)** to finish the call.

## Adjusting the ringer and earpiece volume

### Handset ringer tone

In the standby mode, press **(ringer)**.

Each time **(ringer)** is pressed, the ringer tone setting changes and the selected ringer tone sounds for 2 seconds.

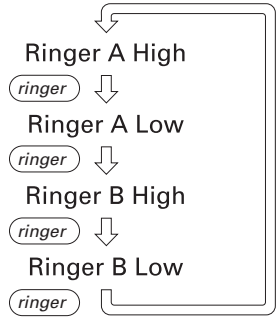

### Handset ringer switch

Use this switch to turn the handset ringer on and off.

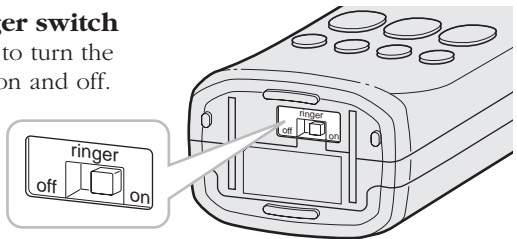

### Handset earpiece volume

Pressing **(▲)** or **(▼)** during a telephone call will change the earpiece volume of the handset. This setting will remain in effect after the telephone call has ended.



When you press **(▲)** in Loud mode or press **(▼)** in Normal mode, error sound beeps.

### Base ringer switch

Use this switch to turn the base ringer on and off.

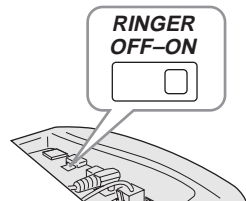

### Base speaker volume

To control the speaker volume of the base, adjust the **(volume ▲)** and **(volume ▼)** button as desired.

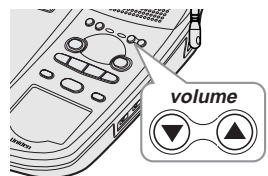

When you wear a headset, the earpiece volume High and Loud will be the same.

## Redialing a call

### From the handset

The last number you called can be quickly redialed.

#### NOTE

If the recently dialed number exceeds 32 digits, only the first 32 digits are retained for redialing.

#### NOTE

To use Long Distance Manager, press **(LongDst)**, instead of **(talk)**.

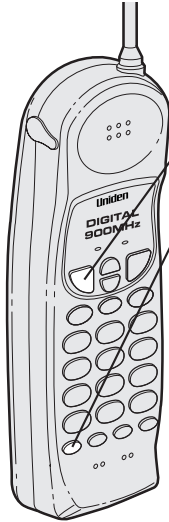

### Handset on the base

- 1 Pick up handset.
- 2 Press **(talk)**. The “**talk/batt**” LED blinks.
- 3 Press **(redial/p)**.
- 4 Press **(talk)** or place the handset on the base to hang up.

## Using the speakerphone

You may use the base as a speakerphone. To answer calls, press **(speaker)** on the base. To hang up, press **(speaker)** again.

The base microphone is located under the base. Position yourself approximately 12 inches away from the base and speak clearly.

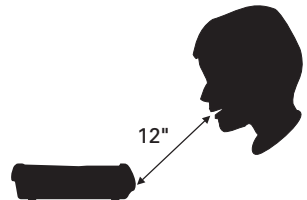

## Mute

You can turn off the sound from the handset microphone.

### When speaking on the handset

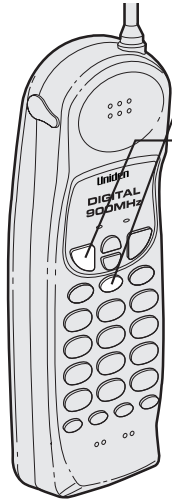

**1** Press **(mute)** during a telephone call, to turn off the handset microphone.

**2** To cancel mute, press **(mute)** or **(talk)**.

### Ringer mute

Press **(mute)** when phone is ringing to immediately mute the ring.

**NOTE**

You must press a key within 20 seconds or the phone will return to standby. If you return the handset to the cradle, the phone will return to standby too. Press **(mem)** and you can go to memory menu at any time.

## Storing phone numbers

Your EXLA 8950 stores up to 10 numbers in handset plus 10.

### On the handset



- 1** Press **(mem)** in the standby mode. The “**talk/batt**” LED flashes.
- 2** Enter the number you wish to store (up to 20 digits).
- 3** Press **(mem)** again.
- 4** Press the keypad **(0)** to **(9)** to select the memory location while you wish to store the number.
- 5** The confirmation beep indicates the number has been stored.

**NOTE**

Press **(redial/p)** to place a pause in the phone number sequence. The phone number you wish to store cannot have more than 20 digits, including Pause.

## Making calls with memory dialing

### From the handset

#### NOTE

To use Long Distance Manager, press **(LongDst)**, instead of **(talk)**.

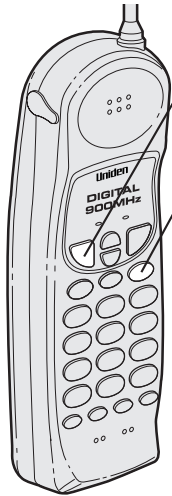

- 1 Pick up the handset.
- 2 Press **(talk)**. The “**talk/batt**” LED blinks.
- 3 Press **(mem)**.
- 4 Press **(0)** - **(9)** on the keypad to select the memory location you wish to dial.
- 5 Press **(talk)** or return the handset to the base to finish the call.

## Erasing a stored phone number

### From the handset



- 1** Press **mem**. The “*talk/batt*” LED blinks.
- 2** Press **mem** again.
- 3** Enter the memory location number **0** - **9** of the number you wish to delete. A confirmation tone indicates the memory has been erased.



## NOTE

Pressing the **speaker** key on the base while dialing with the handset will set the 3-way conversation mode and dialing will continue.



Pressing the **talk** key on the handset will not set the 3-way conversation mode while in the process of dialing with the base.

## NOTE

Dialing from the 3-way conversation mode is possible only from the handset.

# 3-WAY CONFERENCE FEATURES

## 3-way conferencing

The Uniden EXLA 8950 permits 3-way conversations between the handset, base, and an outside line.

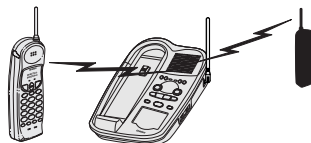

## When speaking on the handset

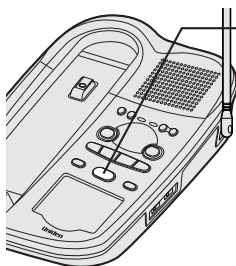

- 1 Press **speaker** on the base. This will set the 3-way conversation mode.
- 2 Press **speaker** on the base, to return to the conversation between the handset and outside line.

## When speaking on the base

### When the handset is off the base



- 1 Press **talk** on the handset. This will set the 3-way conversation mode.
- 2 Press **talk** on the handset, to return to conversing between the base and the outside line.

## Using your EXLA 8950 intercom

### Intercom from the handset to base

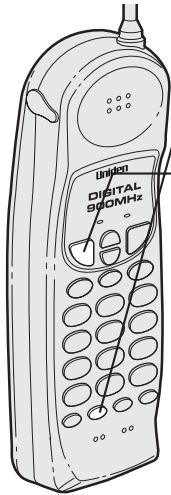

- 1 Press **int'com** on the handset.
- 2 At the base, Press **page/int'com** or **speaker** to answer the page.
- 3 To turn off the intercom, press **talk** on the handset or **speaker** on the base.

### Intercom from the base to handset

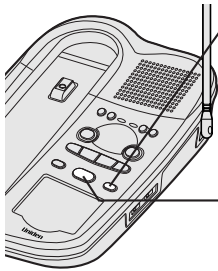

- 1 Press **page/int'com** on the base. The handset beeps.
- 2 Press **int'com** or **talk** on the handset.
- 3 To turn off the intercom, press **talk** on the handset or **speaker** on the base.

## Transferring a call

### To transfer from the handset to the base



- 1** Press **int'com** on the handset while speaking on the handset. The caller is put on hold. The handset and base will enter the intercom call mode. The intercom tone will be sounded on the base.
- 2** Press **page/int'com** or **speaker** on the base. The intercom mode is activated but the caller is still on hold.
- 3** To transfer to the base, press **talk** on the handset.  
To cancel the transfer, press **speaker** on the base.

### To transfer from the base to the handset

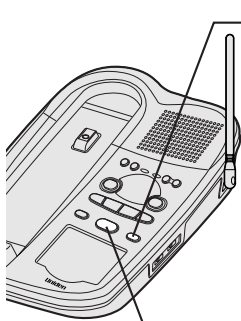

- 1** Press **page/int'com** on the base while speaking on the speakerphone. The caller is put on hold. The handset and base will enter the intercom call mode. The intercom tone sounds on the handset.
- 2** Press **int'com** or **talk** on the handset. The intercom mode is activated, but the caller is still on hold.
- 3** To transfer the handset, press **speaker** on the base.  
To cancel the transfer, press **talk** on the handset.

### The integrated answering device

The EXLA 8950 has a built-in answering system that answers and records incoming calls.

You can also use your answering system to record a conversation, leave a voice memo message for others who use the phone, or to announce a special message to callers when you're away from your phone.

### Features

- Digital Tapeless Recording
- 15 minutes of Recording Time
- Selective Greetings (Outgoing Messages)
- Time and Day Stamp
- Remote Message Retrieval and Room Monitor
- Toll Saver
- Conversation Recording

Digital Tapeless Recording allows you to quickly review, save or delete the messages. You'll never have to worry about a tape wearing out, jamming, or resetting improperly.

The Integrated Answering System is easy and convenient to use, but please read through all of the instructions carefully.

## Setting up your answering system

### Turning the answering system on/off

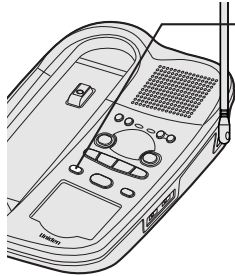

**1** To turn the answering system on, press **(answer on/off)**. A beep tone will sound after the press, greeting message is played.

**2** To turn the answering system off, press **(answer on/off)** again. The EXLA 8950 announces that the answering system turned off.

### Setting the clock

The clock on EXLA 8950 Answer System starts when power is applied to the base. Follow these steps to set the clock to the correct time.

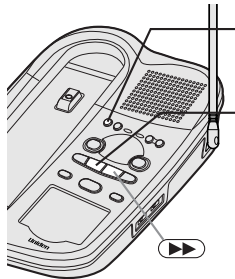

**1** Press and hold **(clock)** until a beep tone sounds.

**2** First, press **(right arrow)** or **(left arrow)** until the correct day of the week is announced. (Number zero through six displays on the base as each day is announced.) Press **(clock)** again to select the day.

**3** Next, press **(right arrow)** or **(left arrow)** until you hear the correct hour setting. Numbers 1 through 12 display on the base as each hour is announced. Press **(clock)** again to select the correct time.

**4** Press **(right arrow)** or **(left arrow)** until you hear the correct time setting. Numbers 1 through 59 display on the base as each minute is announced. Press **(clock)** again to select the correct time.

**5** The LED displays an A or P. Press **(right arrow)** or **(left arrow)** until you hear the correct AM/PM setting.

**6** Press **(clock)** again to end the time/day setting. The EXLA 8950 announces the time that you have set.

#### NOTE

Press **(right arrow)** or **(left arrow)** multiple times to scroll through days, hours, minutes, etc.

#### NOTE

If you don't set the clock within two minutes, the system returns to standby.

## Setting your greeting

When you receive a call, the answering system automatically plays either a preset message or your own greeting.

### ▼ Preset Message

The following message is prerecorded:

"Hello, no one is available to take your call. Please leave a message after the tone."

### ▼ Recording your personal outgoing message (Greeting)

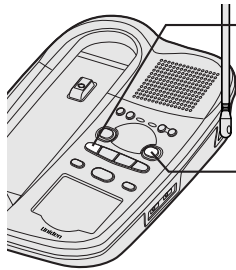

**1** Press and hold **(greeting)** until you hear a long tone. Start recording your message immediately after you hear the long tone end.

**2** When you are finished recording your message, press **(greeting)** or **(play)**. A long tone sounds and your message plays back on the phone.

### NOTE

You can record a greeting up to 30 second.

### NOTE

Stand within 12 inches in front of the microphone and speak clearly when recording your outgoing message.

### ▼ Choosing between two outgoing messages

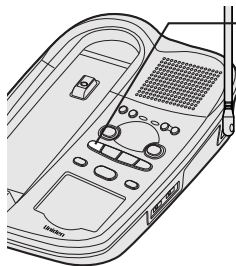

**1** Press **(greeting)** to play the outgoing message.

**2** While the message is playing, press **(greeting)** again to select between your personal greeting and the prerecorded greeting.

## Selecting the message record time

You can set your answering system to record messages up to one or four minutes long.

One minute option:  
move the **REC TIME**  
switch to **1**.

Four minutes option:  
move the **REC TIME**  
switch to **4**.

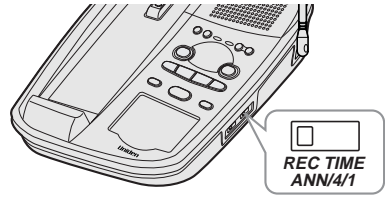

### ▼ Announce only feature:

The announce only feature plays an outgoing message, but it will not allow the caller to leave a message. Move the **REC TIME** switch to the **ANN** position.

The message counter LED displays "R" when system is on standby.



Prerecorded outgoing message for Announce only feature is:

"Hello, no one is available to take your call."





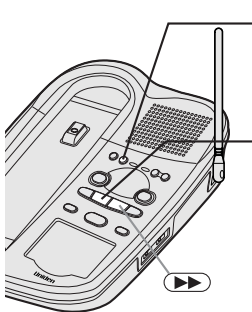

## Selecting a PIN code

To play your messages from a remote location, you will need to enter a two-digit Personal Identification Number (PIN) code (00-99). To select a PIN, perform the following steps.



Press  or  multiple times to scroll through numbers on the display.



- 1** On the base, press and hold  until a beep sounds, and the LED displays 00.
- 2** To set the first number, press  or  to scroll from 00 to 90. When the desired number appears in the display, press . This selects the first number.
- 3** To set the second number, press  or  to scroll from 0 to 9. When the desired number appears in the display, press . This selects the second number and then the entered number is announced.

## Setting ring time switch

The ring time /toll saver switch allows you to set the number of rings the caller hears before the answering system plays your outgoing message. You can set the switch to answer after two rings or after four rings.

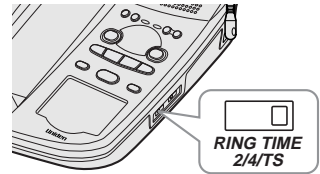

In the **TS** (Toll Saver) position, the answering system picks up after two rings if you have new messages, and after four rings if there are none. This way, if you call long distance to check your messages, you can hang up after third ring to avoid billing charges.



## Using your answering system

### NOTE

To stop playing your messages, press **(play)** again.

### Playing your message

The base LED shows the number of total messages on the display. If the display is blinking, then there are new messages waiting for you. The EXLA 8950 is designed to play your new messages first. After you play your new messages you can then play your old messages.

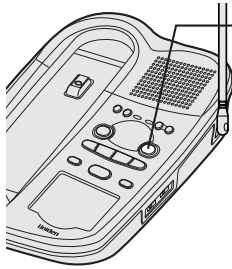

- 1** Press **(play)**. The system announces the number of new and old messages, then the incoming messages are played. The time and day each message was received is announced after the message is played, and the message counter LED displays the number of the current message.
- 2** When all new messages have played, a long tone is heard. The message counter LED stops flashing to indicate that all of the new messages have been reviewed.
- 3** After you have reviewed all your messages, you can play your old messages again. Press **(play)** and follow the instructions above.

## NOTE

Pressing **◀◀** before 2.5 seconds (4.5 seconds from remote) of the message has played causes the system to scan back one message.

## TIP

If you have several messages, press **◀◀** until you return to the message you want to replay.

## NOTE

Each time **▶▶** is pressed, the system scans forward one message.

## NOTE

If you have several messages, press and hold **▶▶** to find the message you want to play.

## Repeating a message

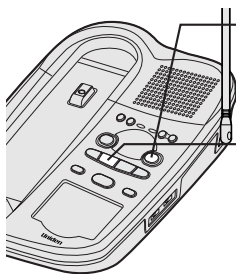

- 1 Press **play** to review your message. The number of stored messages is announced.
- 2 After a message has played for a few seconds, press **◀◀** to repeat the message.
- 3 Press **play** at any time to stop reviewing messages and return to standby. The message counter LED shows the total number of messages still on the system.

## Skipping a message

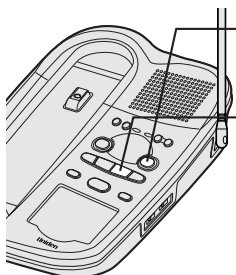

- 1 Press **play** to review your messages. The number of messages is announced.
- 2 Press **▶▶** at anytime to skip to the next message.
- 3 Press **play** at any time to stop reviewing your messages and return to standby. The message counter LED shows the total number of messages on the system.

## NOTE

When you press delete, you are permanently deleting the message. Once deleted, the message cannot be replayed.

## NOTE

The voice memo function is completely independent of the outgoing message. It's handy for leaving others a quick message.

## NOTE

A voice memo message is treated as a typical recorded message and will be added to the stored messages.

## Deleting a message

### ▼ Deleting individual message

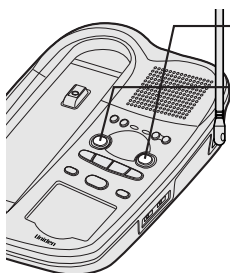

- 1 Press **play** to review your message.
- 2 If you decide to delete a message, press **delete** anytime during the message. The system beeps and immediately goes to the next message.
- 3 After you have played all of your messages, a long tone sounds on the base speaker.

### ▼ Deleting all messages

Press and hold **delete** after reviewing your messages. A tone sounds when all messages are cleared.

## Voice memo

The voice memo function allows the user to record a message (up to 10 minutes) on the base.

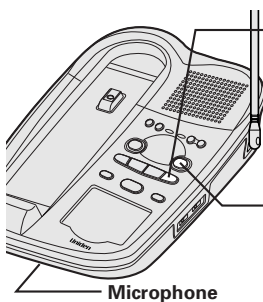

- 1 Press and hold **voice memo**, until you hear a long beep. The message counter LED blinks.
- 2 Speak into the microphone.
- 3 When you have finished, press **voice memo** or **play** to stop recording. The system returns to standby.

## NOTE

A recorded conversation is treated as a typical message and will be added to the stored messages.

## Recording a conversation

You can record up to 10 minutes of conversation while you are making your call from the handset.

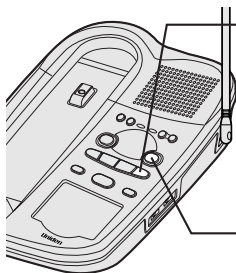

**1** During the conversation from the handset. Press and hold **voice memo** on the base. The unit begins recording and the LED blinks. A beep that can be heard by both parties sounds every 15 seconds.

**2** To stop the recording, press **voice memo** or **play**.

## NOTES

You cannot record a conversation while you are speaking on the base.

## Remote access away from home

You can operate your answering system from a remote location using any touch-tone telephone. Use this function to check for recorded messages, to play or delete messages, even to record a new outgoing message, and to monitor sounds in the room.

- 1 Call your telephone number.
- 2 While the answering machine is activated, press **#** and your PIN code.
- 3 The answering system announces the time and day stamp and the number of messages stored in memory. Then the message playback automatically begins.
- 4 You may continue to listen to your message, or you may select a command from the following chart.

Command	Function
# then <b>1</b>	Repeat
# then <b>2</b>	Playing your messages
# then <b>3</b>	Skipping a message
# then <b>4</b>	Deleting a message
# then <b>5</b>	Stop message playback
# then <b>6</b>	Answering system on
# then <b>7</b>	Voice memo record/stop
# then <b>8</b>	Outgoing message record/stop
# then <b>9</b>	Answer system off
# then <b>*</b>	Room monitor

- 5 After all of your messages have played, or the playback time exceeds 4 minutes, you will hear that the intermittent beeps indicating that the system is in the command waiting mode. You may enter another command at this time from the chart above.
- 6 When you are finished, hang up to exit the system. The answering system automatically returns to standby.



### NOTE

You must enter a command within 15 seconds of entering command waiting mode or the answering system automatically hangs up and returns to standby.



### NOTE

The system will only playback messages for four minutes and then it returns to command waiting mode. To continue playing your message, press **#** then **2** again within 15 seconds

## Remote room monitor

You can call your answering system from any touch-tone phone and monitor sounds in the room where your base is installed.

- 1** Call your telephone number.
- 2** While the answering machine is activated, press **#** and your PIN code.
- 3** The answering system begins announcing the time and day.
- 4** Press **#** then 5 to stop the messages.
- 5** Press **#** then **\***. You hear sounds in the room where your phone is installed. After 15 seconds, the answering system returns to the command waiting mode.
- 6** Press **#** then **\*** to monitor the room for another 15 seconds. Or select another remote function. Or hang up to exit the system. The answering system automatically returns to standby.

## NOTE

If the handset battery pack is completely discharged, or the battery pack removed, the digital security code is erased. If this happens, a new security code is set automatically the next time the battery pack is charged.

ADDITIONAL  
INFORMATION

## Changing the digital security code

The digital security code is an identification code used to connect the handset and the base unit. Normally, setting the code is not necessary.

The first time you charge your handset, the security code is automatically set. (See page 3.)

In the rare situation that you suspect another cordless telephone is using the same security code, you can change the code.

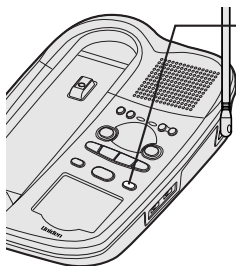

- 1** Remove the handset from the base unit. Press **page/int'com**.
- 2** While the handset is producing the paging sound, hold **page/int'com** while placing the handset in the base unit. The paging tone stops. Leave the handset on the base for at least 3 seconds. A new random security code is set.

## Installing the beltclip

### To attach the beltclip

Insert the beltclip into the holes on each side of the handset. Press down until it clicks.

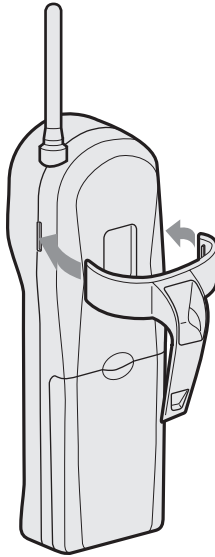

### To remove the beltclip

Pull both sides of the beltclip to release the tabs from the holes.

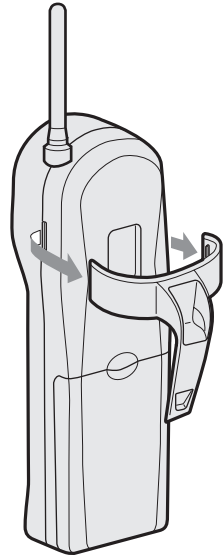

## Headset installation

Your phone may be used with an optional headset. To use this feature, simply plug any standard 2.5mm headset plug into the headset jack. Your phone is ready for hands-free conversation.

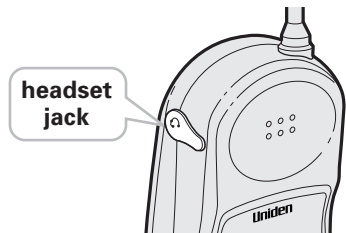



## Note on power sources

### Battery replacement and handling

When the operating time becomes short, even after a battery is recharged, please replace the battery.

With normal usage, your battery should last about one year. Please contact your place of purchase for a replacement battery.

#### Power Failure

During the period that the power is off, you will not be able to make or receive calls with the telephone.

### RECYCLING NICKEL-CADMIUM BATTERIES

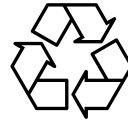

**NICKEL-CADMIUM BATTERIES MUST BE DISPOSED OF PROPERLY.**

Nickel-cadmium cells are used in the battery pack. Please take your used nickel-cadmium battery packs to a store that recycles nickel-cadmium batteries.

#### Caution

- Use the specified battery pack.
- Do not remove the battery from the handset to charge it.
- Never throw the battery into a fire, disassemble it, or heat it.
- Do not remove or damage the battery casing.

## Maintenance

#### When slightly dirty

Wipe with a soft, dry cloth.

#### When very dirty

Wipe with a soft cloth that has been dampened with diluted, neutral detergent. Dry with a dry cloth.

#### When the charging terminals become dirty

Wipe with a pencil eraser or other contact cleaner.

#### Caution

Do not use paint thinner, benzene, alcohol, or other chemical products. Doing so may discolor the surface of the telephone and damage the finish.

## Troubleshooting

If your phone is not performing to your expectations, please try these simple steps first.

Symptom	Suggestion
The <b>status</b> light won't come on when the handset is placed in the base unit.	<ul style="list-style-type: none"> <li>• Make sure the AC adapter is plugged into the base unit and wall outlet.</li> <li>• Make sure the handset is properly seated in the base unit.</li> <li>• Make sure the charging contacts on the handset and base unit are clean.</li> </ul>
The audio sounds weak and/or scratchy.	<ul style="list-style-type: none"> <li>• Make sure that the base unit antenna is in a vertical position.</li> <li>• Move the handset and or base unit to a different location away from metal objects or appliances and try again.</li> <li>• Press (<b>chan</b>) to help eliminate background noise.</li> <li>• Make sure that you are not too far from the base.</li> </ul>
Can't make or receive calls.	<ul style="list-style-type: none"> <li>• Check both ends of the base unit telephone line cord.</li> <li>• Make sure the AC adapter is plugged into the base unit and wall outlet.</li> <li>• Disconnect the AC adapter for a few minutes, then reconnect it.</li> <li>• Reset the digital security code (See page 36).</li> <li>• Make sure (<b>talk</b>) is pressed.</li> </ul>
The handset doesn't ring or receive a page.	<ul style="list-style-type: none"> <li>• The battery pack may be weak. Charge the battery on the base unit for 12-15 hours.</li> <li>• The handset may be too far away from the base unit.</li> <li>• Move the base unit away from appliances or metal objects.</li> <li>• Reset the digital security code (See page 36).</li> </ul>

<b>Symptom</b>	<b>Suggestion</b>
The answering system does not work.	<ul style="list-style-type: none"> <li>• Make sure the base unit is plugged in.</li> <li>• Make sure that the answering system is turned on.</li> </ul>
Messages are incomplete.	<ul style="list-style-type: none"> <li>• The incoming messages may be too long. Remind callers to leave a brief message.</li> <li>• The memory may be full. Delete some or all of the saved messages.</li> </ul>
After a power failure, the outgoing message is deleted.	<ul style="list-style-type: none"> <li>• Record your greeting again. The default messages should remain.</li> </ul>
No sounds on the base unit speaker during call monitoring or message playback.	<ul style="list-style-type: none"> <li>• Adjust the speaker volume on the base unit.</li> </ul>
Cannot access remote call-in features from another touch-tone phone.	<ul style="list-style-type: none"> <li>• Make sure you are using the correct PIN number.</li> <li>• Make sure that the touch-tone phone you're using can transmit the tone for at least two seconds. If it cannot, you may have to use another phone to access your message.</li> </ul>

## Specifications

### General

The EXLA 8950 complies with FCC Parts 15 and 68.  
 Frequency control: PLL  
 Modulation: Frequency shift keying  
 Operating temperature: 0°C to +50°C (+32°F to +122°F)

### Base unit

RX frequency: 902.119 MHz to 905.016 MHz (30 channel)  
 TX frequency: 924.997 MHz to 927.894 MHz (30 channel)  
 Power requirements: 9V 350mA (from AC adapter)  
 Size: 8-49/64 in. (W) x 6-57/64 in. (D) x 2-37/64 in. (H)  
 (222.5 mm (W) x 175 mm (D) x 65.3 mm (H))  
 Weight: Approx. 20.4 oz. (Approx. 579 g)

### Handset

RX frequency: 924.997 MHz to 927.894 MHz (30 channel)  
 TX frequency: 902.119 MHz to 905.016 MHz (30 channel)  
 Power requirements: Rechargeable Nickel-Cadmium battery pack  
 Size (without antenna): 7 in. (W) x 2-17/64 in. (D) x 2 in. (H)  
 (178 mm (W) x 57.6 mm (D) x 51 mm (H))  
 Weight: Approx. 8.6 oz. (244 g) (including battery)  
 Battery: BT-905  
 Capacity 600 mAh, 3.6V  
 Talk mode 7 hours TYP  
 Standby mode 7 days TYP

Specifications, features, and availability of optional accessories are all subject to change without prior notice.

## At Uniden, we'll take care of you!

If you need any assistance with this product, please call our Customer Hotline at

**1-800-297-1023**

**PLEASE DO NOT RETURN THIS PRODUCT TO THE PLACE OF PURCHASE.**

Our Uniden representatives will be happy to help you with any matters regarding the operation of this unit, available accessories, or any other related matters.

Thank you for purchasing a Uniden product.  
 Hours: M-F 7:00 AM to 7:00 PM CST.

## Index

**0 - 9**  
 3-way conferencing.....22

**A**  
 Answering device  
     Features.....25  
     Setting up.....26  
     Using.....30

**B**  
 Base ringer switch.....16  
 Battery pack  
     Preparing and  
     charging.....10  
     Replacement and  
     handling.....38

**C**  
 Channel.....12  
 Connection.....6

**D**  
 Dialing mode.....7  
 Digital security code.....3, 36

**E, F, G**  
 Earpiece volume.....16

**H**  
 Headset installation.....37

**I, J, K**  
 Intercom.....23  
 Installing the beltclip.....37

**L**  
 Long distance manager.....13

**M, N, O**  
 Maintenance.....38  
 Making a call.....12  
 Memory dialing  
     Making a call  
     with memory dialing.....20  
     Erasing a stored  
     phone number.....21  
     Storing phone  
     numbers.....19

Mounting the base unit  
 to a wall.....8  
 Mute.....18

**P, Q**  
 Package contents.....4

**R**  
 Receiving a call.....15  
 Redialing a call.....17  
 Handset ringer tone.....16  
 Handset ringer switch.....16

**S**  
 Setting up your answering  
 system  
     Selecting a PIN code.....28  
     Selecting the  
     message record time.....28  
     Setting the clock.....26  
     Setting ring time  
     switch.....29  
     Setting your greeting.....27  
     Turning the answering  
     system on/off.....26

Setup  
     Base unit.....5  
     Handset.....10  
 Specifications.....41

**T**  
 Transferring a call.....24  
 Troubleshooting.....39

**U, V, W, X, Y, Z**  
 Using your answering system  
     Deleting a message.....32  
     Playing your message.....30  
     Recording a  
     conversation.....33  
     Remote access  
     away from home.....34  
     Remote room monitor.....35  
     Repeating a message.....31  
     Skipping a message.....31  
     Voice memo.....32

# THANK YOU

FOR PURCHASING A UNIDEN PHONE!

**Uniden®**

Covered under one or more of the following U.S. patents:

4,511,761 4,523,058 4,595,795 4,797,916 5,381,460  
5,426,690 5,434,905 5,491,745 5,533,010 5,574,727  
5,650,790 5,660,269 5,661,780 5,663,981 5,671,248  
5,717,312 5,754,407 5,768,345 5,787,355 5,838,721

© June 1999 Uniden America Corporation

All rights reserved • Printed in China UCZZ01631BZ

## Free Manuals Download Website

<http://myh66.com>

<http://usermanuals.us>

<http://www.somanuals.com>

<http://www.4manuals.cc>

<http://www.manual-lib.com>

<http://www.404manual.com>

<http://www.luxmanual.com>

<http://aubethermostatmanual.com>

Golf course search by state

<http://golfingnear.com>

Email search by domain

<http://emailbydomain.com>

Auto manuals search

<http://auto.somanuals.com>

TV manuals search

<http://tv.somanuals.com>