

Uniden®

OWNER'S MANUAL



**UNIDEN Model uh015sx UHF
CB Radio**

Contents

Introduction	3
Features	3
Preventive Maintenance	3
Troubleshooting	3
Controls / Connectors	4
Indicators	5
Package Contents	6
Mounting Options	7
Operation	9
Setting the Squelch	9
Monitor	9
Selecting a Channel/POLICE and CB Channel Groups	9
Transmitting	10
Using Repeater Channels (Duplex Mode)	10
Operating the uh015sx in Duplex Mode	11
Scanning	11
Open Scan (OS) Mode	11
Group Scan (GS) Mode	12
Memorizing Channels and Frequencies for Scan	13
Wide Band Searching	13
60 RX Channels	14
Manual Programming	14
Copying a Police frequency to a RX Channel	14
Copying a frequency found using SEARCH to a RX Channel	15
Busy Channel Lockout	16
VOX Operation (optional VOX headset required)	16
Programming the Instant Priority Channel	16
Recalling the Instant Channel	16
CTCSS (Continuous Tone Coded Squelch System)	17
DCS (Digitally Coded Squelch)	17

Contents

Selective Calling	18
Outline	18
Receiver Quieting	18
Call Receiving	19
Tone Squelch Scanning	20
Tone Calling	20
5/6 TX Tone Selcall Programming	21
Group Calling	22
TX Selcall ID Format	22
5/6 Tone Selcall Programming	23
Receiver Selcall ID	24
Programming Your Selcall ID	24
Other Selcall Parameters	26
Selcall ID	27
Tone Period	27
Lead-in Delay	28
Lead-in Tone	30
Alarm Mode	32
Group Call Mode	34
Default Settings	35
Selcall Tone Frequency List	35
UHF-CB Channels & Frequencies	36
CTCSS & DCS Code List	37
Warranty	38

UNIDEN Model uh015sx UHF CB Radio

Introduction

The Uniden uh015sx is designed to provide you with years of trouble free service. Its rugged components and materials are capable of withstanding harsh environments. Please read this Operating Manual carefully to ensure you gain the optimum performance of the unit.

NOTE

The citizen band radio service is licenced in Australia by ACMA Radio-communications (Citizen Band Radio Stations) Class Licence and in New Zealand by MED General User Licence for Citizen Band Radio and operation is subject to conditions contained in those licenses.

Features

- Detachable Display Unit
- Transmit & Receive FM 40CH (UHF-CB, TX Power 5W)
- 60 Programmable RX Channels
- 115 Pre-programmed Police Frequencies (65 for Australia, 50 for New Zealand)
- 3 Levels Preset Squelch
- Wide Band Scanner (400MHz - 512MHz)
- Band Search Function (5 Bands separately)
- LCD Display with Backlight
- Signal Strength Meter
- RF Power Indicator
- One touch Instant Channel recalling
- Duplex Capability (from CH01 - CH08)
- Group Scan and Priority Channel Watch
- Open Scan
- Busy Channel Lock-out
- 38 Built-in CTCSS codes & 104 additional DCS codes
- Volume Control with Power On/Off Switch
- VOX (Voice Activated Function) optional VOX headset required
- 9 Step VOX Mic sensitivity adjustment
- Memory backup if power fails
- Tone Squelch Function (5/6 Tone)
- Tone Calling Function (5/6 Tone)
- Tone Squelch Scan
- W125mm x H35mm x D156mm(including Display Unit) - allow 40mm+ for antenna fitting at rear of unit.
- DIN mountable (optional DIN mount kit required)

Preventative Maintenance:

The following system checks should be made every six to twelve months:

- Check the Standing Wave Ratio (SWR).
- Inspect the tightness of all electrical connections.
- Inspect the antenna coaxial cable for wear or breaks on the shielding.
- Inspect the tightness of all screws and other mounting hardware.

Troubleshooting:

Should the unit malfunction or perform poorly, follow these procedures:

If the transceiver is completely inoperative: Check the power cord and fuse.

If there is trouble with receiving: Check the VOLUME control setting. Be sure the SQUELCH is adjusted properly. Possibly the radio is over-squelched.

If there is trouble with transmitting: Check that the transmission line (coaxial cable) is **securely connected to the ANTENNA** connector. Check that the antenna is fully extended for proper operation. Check that all transmission line (coaxial cable) connections are secure and free of corrosion.

NOTE

Blackening may occur on the Liquid Crystal Display if the uh015sx has been subjected to extreme high temperature (above 60°C) . This is not a fault. Normal LCD operation resumes when the temperature stabilizes back to standard operating

UNIDEN Model uh015sx UHF CB Radio

Controls/Connectors

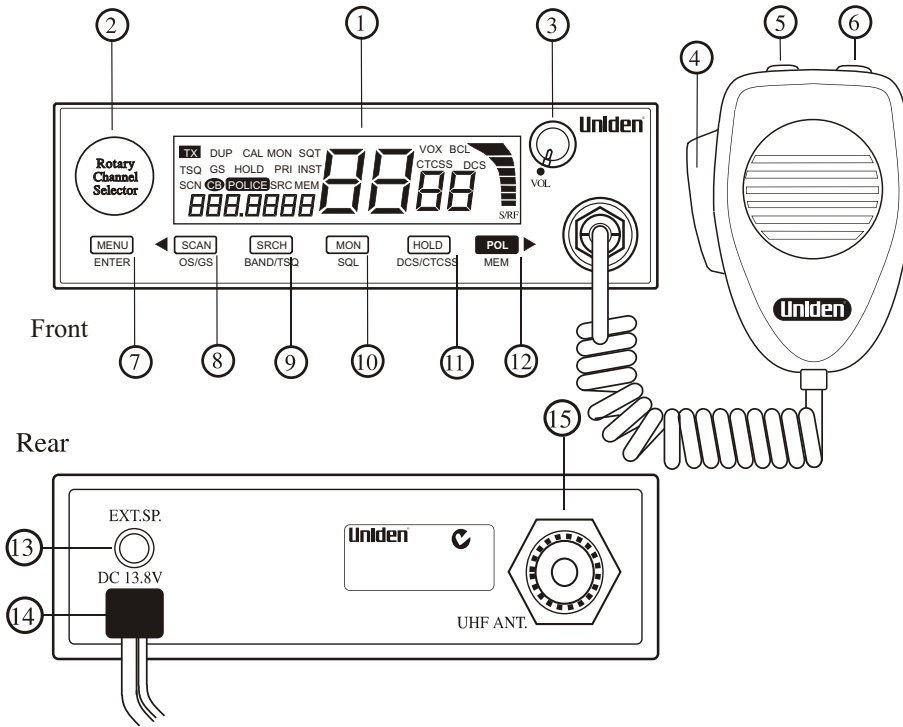

Controls and Connectors

Ref Item	Page	Ref Item	Page
① Liquid Crystal Display (LCD)	5	⑨ SRCH - Search, Search Band/Tone Squelch	13
② Rotary Channel Selector (Rotary Knob)	9	⑩ MON - Monitor, Squelch button	9
③ On/Off Volume	9	⑪ HOLD - Hold, DCS/CTCSS button	11, 17
④ Push to Talk (PTT) Button	10	⑫ POL ▶ - Channel Group Select (Police, CB), Memory, move right button	14
⑤ TCAL - Tone Call	20	⑬ External Speaker Jack	-
⑥ INST - Instant Channel Recall and Instant Channel Programming	16	⑭ Power Input (13.8V DC)	-
⑦ MENU - Menu, Enter button	11	⑮ UHF Antenna Connection	-
⑧ SCAN - Move left, Scan, Open/Group Scan button	11,12		

Indicators

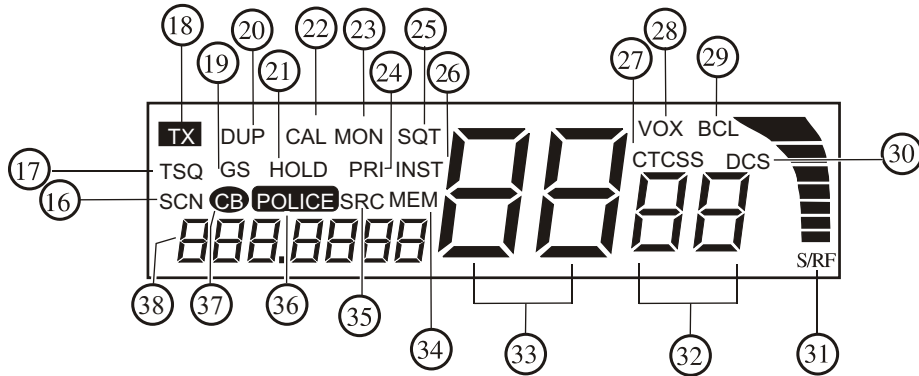

Indicators

<i>Ref. Item</i>	<i>Page</i>	<i>Ref. Item</i>	<i>Page</i>
16 SCN - Scan	11	29 BCL - Busy Channel Lockout	16
17 TSQ - Tone Squelch	18	30 DCS - Digital Coded Squelch	17
18 TX - Transmit	10	31 S/R/F - RF Strength Meter	-
19 GS - Group Scan	12	32 DCS/CTCSS Code Indicator	17
20 DUP - Duplex	10	33 Channel Number Indicator	9
21 HOLD - Hold	11 - 15	34 MEM - Memory	11,13
22 CAL - Tone Call	20	35 SRC - Search	13
23 MON - Monitor	9	36 POLICE - Police channel	9
24 PRI - Priority	12	37 CB - CB channel	9
25 SQT - Squelch	9	38 Frequency Indicator	9
26 INST - Instant Channel	16		
27 CTCSS - Continuous Tone Coded Squelch System	17		
28 VOX - Voice Activation	16		

UNIDEN Model uh015sx UHF CB Radio

Package Contents



uh015sx Owners Manual

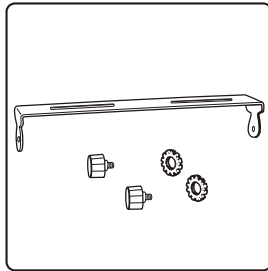

Display Mount Bracket

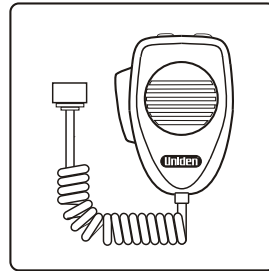

Microphone

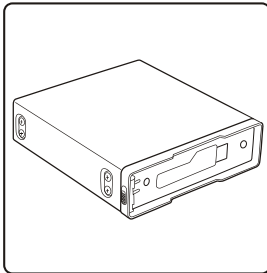

Transceiver

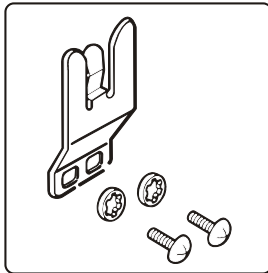

Microphone Hanger, Screws and Washers

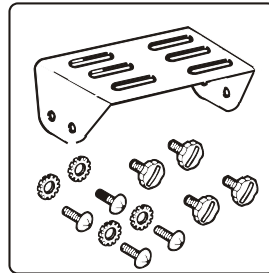

Mounting Bracket, Knobs, Washer Stars and Screws

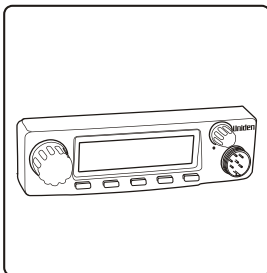

Display Unit

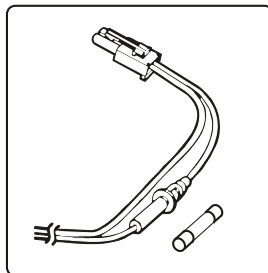

DC Power Cord with Fuse

Optional Accessories

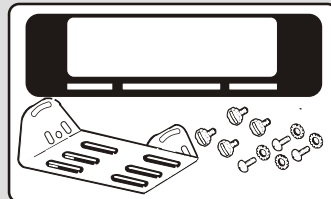

DIN Mounting Kit (DMK8990)

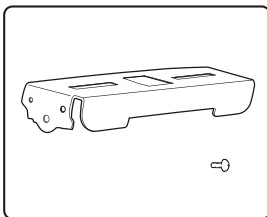

Display Rear Bracket

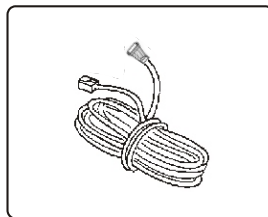

Extension Cable

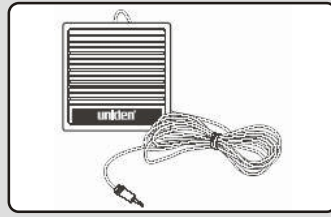

External Speaker (MS100)

Mounting Options

The radio can be mounted complete - or - with the Display Unit remote of the Transceiver.

Mounting the complete radio (Transceiver with Display Unit)

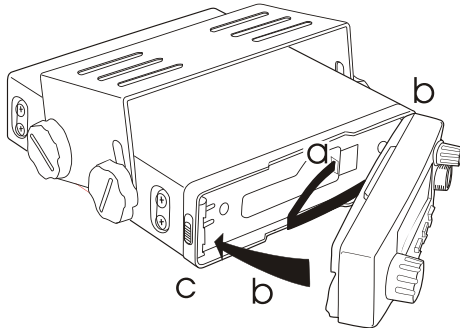

- a) Plug in display cable from the Display Unit to the transceiver.
- b) Hinge the Display Unit into the transceiver as shown in the diagram, then snap closed.
- c) Should you wish, at a later stage, to position the Display Unit remote from the Transceiver, release the Display Unit by pushing up the slide on the side.

Remote mounting of the Transceiver Unit

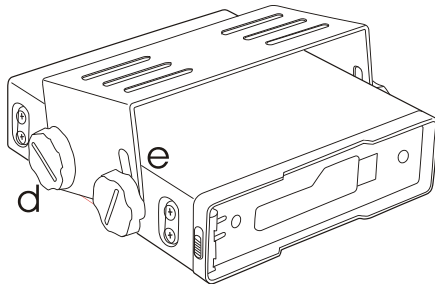

If the Display Unit is not already separate of the Transceiver then remove it as detailed in c) above.

Fix the Transceiver Mounting Bracket in an appropriate location (screws and washers supplied). Then fix the Transceiver in the bracket using the Knob bolts supplied d).

The bracket can be fixed on the top or under the transceiver. An arced slot e) allows you to mount the transceiver at an angle.

Changing Remote Extension Cable

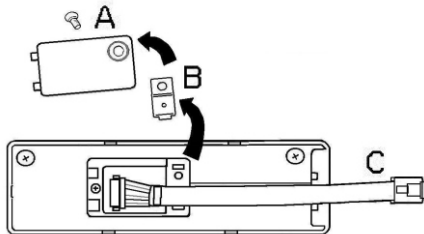

At the back of the Display Unit unscrew the cable cover A) and release bracket B).

Unplug the short cable C) and plug in the extension cable.

Replace bracket B) over the cable. Then replace back cover A) and screw in place.

Mounting Options

Remote mounting of the Display Unit

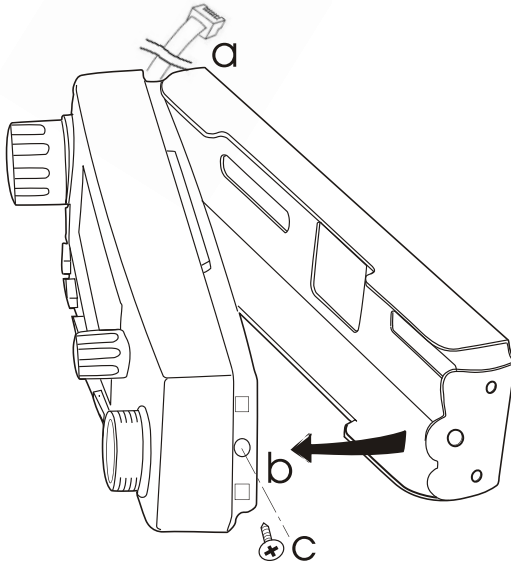

Fixing the Display Rear Bracket

To mount the Display Unit it needs to be fitted with a Display Rear Bracket (included in package).

- a) Position the Display Rear Bracket so that one end fits over the two studs at the end of the Display Unit.
- b) Push it into place until the fixing screw hole is aligned with its threaded counterpart.
- c) Secure the Display Rear Bracket with the screw provided.

Optional mounting positions

The Display Unit can be mounted from the top, back or bottom.

- d) Fix the Display Mount Bracket in place (above, at the rear or at the bottom) by screwing through the slots in the bracket.
- e) Fix the Display Unit to the bracket with the thumb screws provided.
- f) Connect the Extension Cable between the Display Unit and the Transceiver.

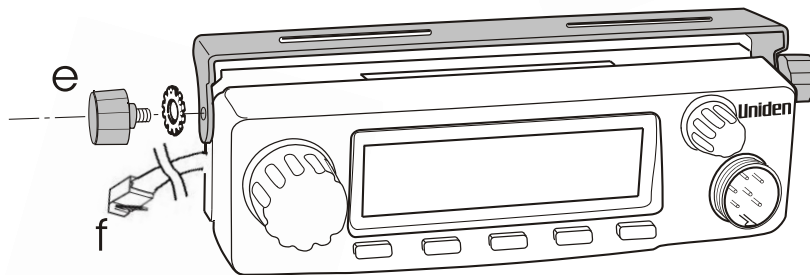
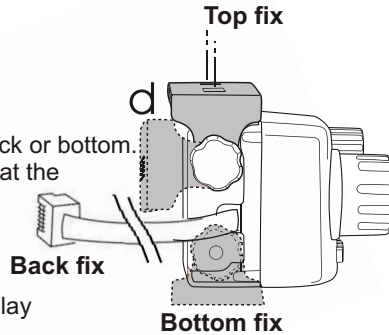

Operation

Setting the Squelch

Turn the Unit ON by rotating the volume control clockwise. The uh015sx has 3 preset squelch levels:

- 1 - max sensitivity (min squelch)
 - 2 - med sensitivity (med squelch)
 - 3 - min sensitivity (max/tight squelch)
- It requires no adjustment.

Press and hold **MON**. The squelch will flash. Turn rotary knob to select. Press **MON** to set. The **SQT** icon appears if level 3 is selected.

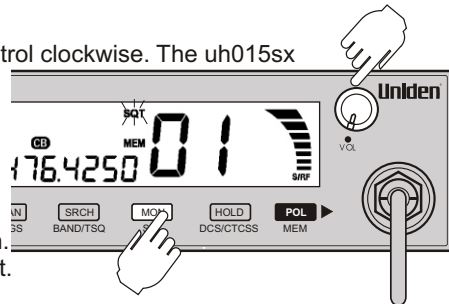

- Selecting tight squelch mode may prevent the reception of weak signals.
- High noise areas may still break the squelch.

Monitor

Press **MON** to open the squelch and receive all weak signals. Press **MON** again momentarily to cancel.

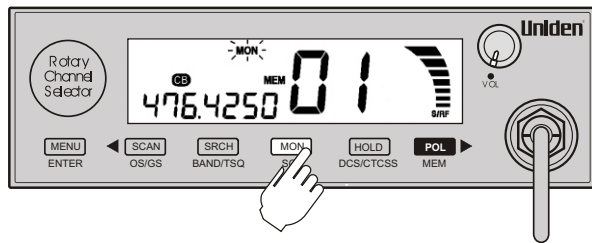

Selecting a Channel/POLICE and CB Channel Groups

Turn the Rotary Channel Selector to select the desired channel.

The uh015sx has two groups of channels to select from. When the **CB** icon is showing the 40 UHF-CB and any user programmed RX channel will be available for selection or scanning. When the **POLICE** icon is showing then the 115 police frequencies will be available. Press **POL** to select which group(s) to activate or deactivate.



For your reference a list of the available UHF CB channels, corresponding frequencies and guidelines for their use is printed on page 36. For Australia, Channels 05 and 35 are reserved for Emergency Calls.

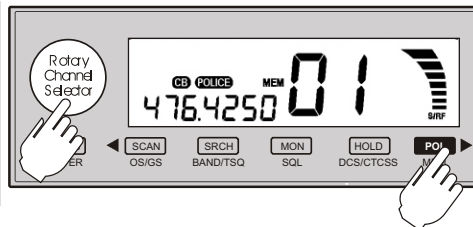

The 40 UHF-CB channels are numbered 1-40. The programmable RX channels are numbered 41-100 (100 is shown as o0) - and only show when programmed. The 115 police frequencies do not have channel numbers but you can still select them (- - appears in the channel display) or copy them to a programmable RX channel.

Operation

Transmitting

The uh015sx uses the 40 UHF-CB Channels. See page 36 for UHF-CB Channels & Frequencies.



Channels 22 and 23 are for telemetry and telecommand applications. Transmit is inhibited on these channels.

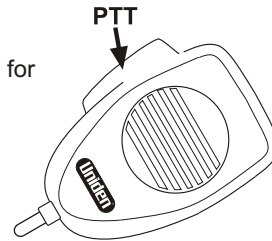

Select the desired channel. Press the microphone's PTT button and speak normally into the microphone. Hold it approx. 7cm from your mouth. The **TX** icon appears while transmitting. Release the PTT button to end the transmission and listen for a reply.

Using Repeater Channels (Duplex Mode)

UHF CB repeaters are used to retransmit or relay your signal. Repeaters will extend the range of your radio and overcome the shielding effect caused by solid obstructions. In normal Simplex operation, your radio transmits on one particular frequency and receives on that same frequency. If there is a barrier that partially blocks your transmitted signal, the probability of another radio receiving the signal is very slim. Hills, tall buildings, metallic structures,...etc tend to act as a screen between radios.

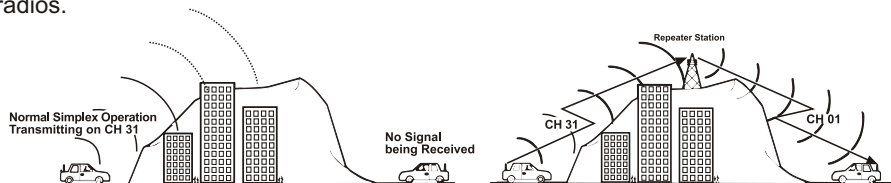

Standard Operation without the aid of a Repeater Station.

Operation with the aid of a Repeater Station (Duplex).

The signal coming from your radio is received by the Repeater Station and then re-transmitted at the same time on another channel. This operation is called "Duplexing".

For example,

CH01 on Duplex Mode will Receive on CH01 but Transmit on CH31

CH02 on Duplex Mode will Receive on CH02 but Transmit on CH32 etc...

If you transmit on CH01 Duplex mode, you are actually transmitting on CH31 the repeater station down-converts your signal and retransmits on CH01.

Operation

Operating the uh015sx in Duplex Mode

For this example we are adopting CH01 as the channel being used in your area for repeater use.

To Set Duplex ON/OFF

Press **[MENU]** once. The DUP setting will flash. Turn the rotary knob to adjust the setting to *ON* or *OFF*. Press & hold **[MENU]** /ENTER to set. A confirmation tone sounds.

The **DUP** icon appears.

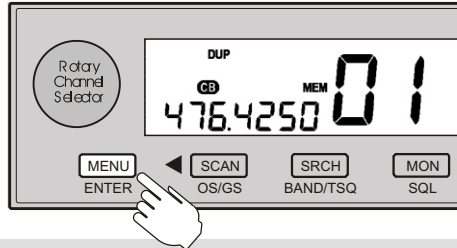

- Only channels 01 - 08 are available for Duplex.
- Check with your local Retailer for information on available repeaters.
- If a button is not pressed within 10 seconds the uh015sx will automatically exit MENU Mode.

Scanning

The uh015sx scanning feature allows you to search the **SCAN MEMORY** for active channels automatically.

The scan memory has two main groups; Open Scan (OS) and Group Scan (GS), OS Scan searches all the channels and frequencies in its memory continuously. GS Scan has the ability of monitoring a priority channel every 1.5 seconds while searching channels and frequencies in its memory.

Furthermore, while scanning you can select which channel groups to activate (CB or POLICE).

Press **[SCAN]** and Scanning starts.

The **SCN** icon appears.

You may change the scan direction by turning the rotary channel selector.

Press **[SCAN]** again to exit scanning.

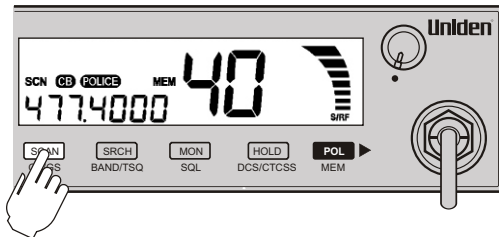

Open Scan (OS) Mode

Allows continuous scanning of channels stored in the Open Scan memory. If an active channel is found, scanning will stop on that channel.

This example shows CH17 active.

If the received signal ceases, the unit will wait 3 seconds for the signal to return, otherwise scanning resumes. During Scan you may...

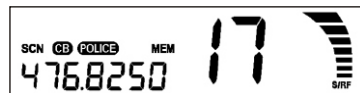

- Press **[HOLD]** to hold scan. Press **[HOLD]** again to resume scan.
- If scan stops on a frequency and you wish to continue then turn rotary channel selector.
- The direction of scan can be changed using the rotary channel selector.
- To remove an active channel from scan memory press and hold **[POL]** /MEM and scan resumes.
- Press and hold **[SCAN]** /OS/GS for 2 seconds to switch between GS and OS modes. To deactivate scan, press **[SCAN]** momentarily.



- When Scan is deactivated the starting channel will be reinstated.
- If scan is deactivated while on hold the hold channel will be reinstated.
- OS Mode is indicated by the absence of the GS icon.

Operation

Group Scan (GS) Mode

NOTE The GS scan memory is empty at factory setting. Channels and frequencies must be memorized to GS scan memory for scan to work in GS mode (see p.13).

Allows you to monitor a Priority channel while scanning other channels in the GS memory. The Priority channel is the same as the Instant Priority Channel, see p.16.

To monitor the Priority channel during **GS** the priority setting in the menu must be on. Press **[MENU]** 2 times. The priority icon and setting will flash. Turn rotary knob to select on. Press and hold **[MENU]** /ENTER to confirm. The **PRI** icon appears.

NOTE If the priority setting is not turned on, then GS can be used in the same way as OS.

To switch to GS Mode, press and hold **[SCAN]** for 2 seconds. **GS** icon appears on the display.



GS Scanning checks the Instant Priority Channel for activity regularly. If the Priority Channel becomes active the radio will stay on that channel for as long as the signal is present. If the received signal ceases, Priority Scanning continues after 3 seconds.

If scanning stops on a channel which is not a Priority Channel, uh015sx will continue monitoring the Priority Channel for activity while listening to the active one.

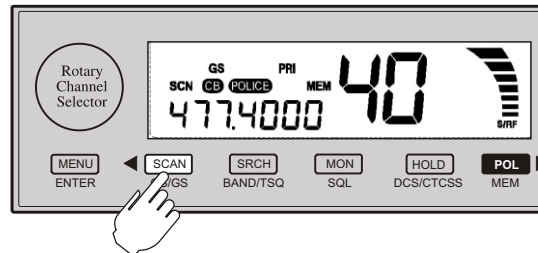

During Scan you may...

- Press **[HOLD]** to hold scan. Press **[HOLD]** again to resume scan.
- If scan stops on a frequency and you wish to continue then turn rotary channel selector.
- The direction of scan can be changed using the rotary channel selector.
- To remove an active channel from scan memory press and hold **[POL]** /MEM and scan resumes.
- Press and hold **[SCAN]** /OS/GS for 2 seconds to switch between GS and OS modes. To deactivate scan, press **[SCAN]** momentarily.

NOTE

- When Scan is deactivated the starting channel will be reinstated.
- If scan is deactivated while on hold the hold channel will be reinstated.

Operation

Memorizing Channels and Frequencies for Scan

Press and hold **[SCAN]** /OS/GS to select the scanning mode you wish to store to - OS or GS. Press **[POL]** to activate the channel group(s) you wish to select from - CB and/or POLICE. Turn the rotary channel selector to select the channel you wish to add to the OS or GS scan memory.

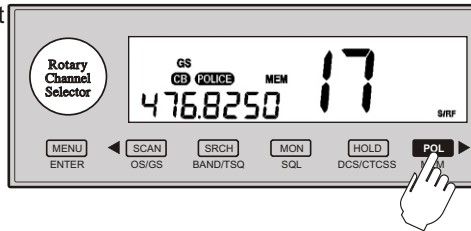

Press and hold **[POL]** /MEM to add to the scan memory of the selected scan mode. **MEM** icon appears and two beeps are heard.

To remove channel from Scan Memory, press and hold **[POL]** /MEM once more. The **MEM** icon disappears.

NOTE

- OS is indicated by the absence of the **GS** icon.
- All channels and frequencies can be added to the scan memory. Initial factory settings are:
OS scan memory - All UHF-CB frequencies and Australian Police frequencies.
GS scan memory - No channels or frequencies*.

*Scanning in GS mode cannot begin until a channel or frequency is added to the GS scan memory.

Wide Band Searching

The uh015sx has a wide band search feature which will allow you to search Frequencies ranging from 400-512MHz (in 12.5kHz steps). You may search the full range (All) or search one of 4 smaller bands separately.

400-420MHz	band A
420-450MHz	band b
450-470MHz	band c
470-512MHz	band d
400-512MHz	All

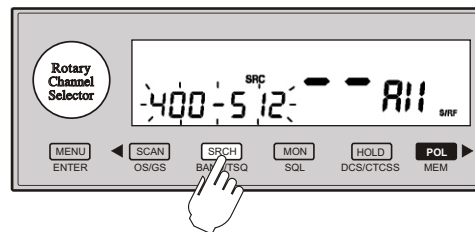

Press **[SRCH]** /BAND. The search band indicator will flash for 3 seconds. While it flashes you may change the band search by turning the rotary knob. Search begins automatically after 3 seconds of inactivity.

During search you may...

- Press **[HOLD]** to hold search. Press **[HOLD]** again to resume scan.
- If search stops on a frequency and you wish to continue search then turn rotary channel selector.
- If search stops on an unwanted frequency press **[HOLD]** and then press and hold **[POL]** /MEM to set lockout ON/OFF. Press **[HOLD]** to resume search.
- The direction of search can be changed (up or down) by turning the rotary channel selector. To exit search, press **[SRCH]** momentarily.

Operation

60 RX Channels

The uh015sx has 60 receive only channels (CH41 to CH100) which can be programmed with frequencies ranging from 400-512MHz (in 12.5kHz steps). If you know the frequency you may store it manually or you may copy a Police frequency to a channel or you may use the search function to find an active frequency and copy it to a channel.

Manual Programming

Turn power off. Press and hold **MON** while turning power back on. The channel indicator flashes the lowest available empty channel. You may use the rotary knob to select another channel.

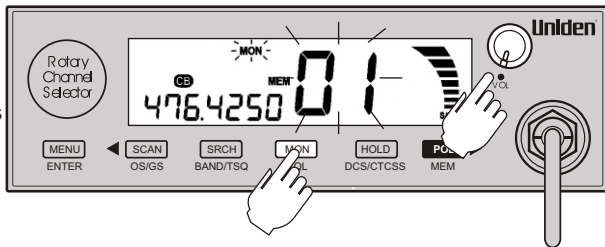

Press **MENU**. The first digit of the frequency indicator flashes. Turn rotary knob to select first digit. Press **SCAN** or **POL** to move left or right between digit positions and turn rotary knob to change digits.

When finished press **MENU**/ENTER, the channel indicator flashes. Turn rotary knob to select next channel for programming or press and hold **MENU**/ENTER to store setting. A confirmation tone sounds. The channel is also entered into OS scan memory.

Deleting a programmed RX Channel frequency:

Follow the steps in Manual Programming to enter a frequency for a desired channel. Select 0 for the first frequency digit and then press **MENU**/ENTER. Turn rotary knob to select another channel or press and hold **MENU**/ENTER to exit programming mode.

Copying a Police frequency to a RX Channel

Select the Police channels group by pressing **POL** then select a desired frequency using the rotary knob.

Press and hold **MENU**. The lowest available empty channel will appear, alternating with the selected Police frequency. You may change the channel using the rotary knob if you desire.

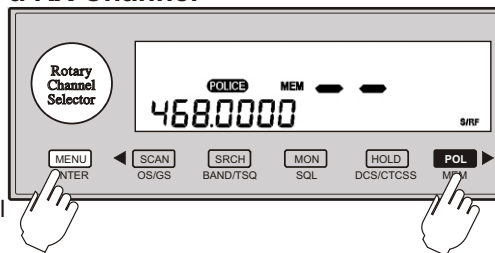

Press **MENU**/ENTER to store the frequency to the channel.

The new setting is stored and the uh015sx returns to Police CH.

Operation

Copying a frequency found using SEARCH to a RX Channel

Start Search feature. When an active frequency is found which you wish to store press **HOLD** to stay on that frequency. Press and hold **MENU** /ENTER .

The next available empty channel will show, alternating with the Search frequency. Turn Rotary Channel Selector if you wish to select another channel.

Press **MENU** /ENTER to store to selected channel. The new setting is stored and the uh015sx returns to search hold mode.

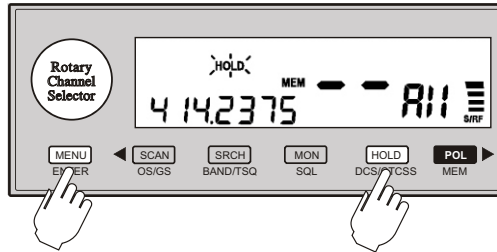

Operation

Busy Channel Lockout

If the channel is already in use, you can prevent the uh015sx from transmitting. This is particularly important when using CTCSS/DCS.

Press **[MENU]** 4 times. The BCL setting will flash. Turn the Rotary Channel Selector to display **BCL**. Press and hold **[MENU]/ENTER** for 2 seconds to store the new setting.

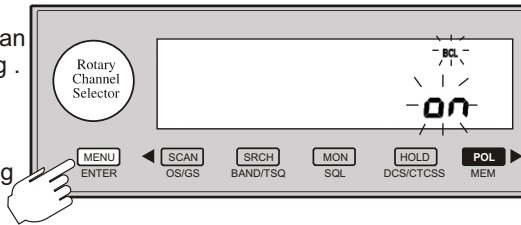

NOTE

If a button is not pressed within 10 seconds the uh015sx will automatically exit Select Mode.

VOX Operation (optional VOX headset required)

Press **[MENU]** 3 times. The BCL setting will flash. Turn the Rotary Channel Selector to select the desired VOX sensitivity (1 - 9). Press and hold **[MENU]/ENTER** for 2 seconds to store the new setting. Connect the VOX headset.

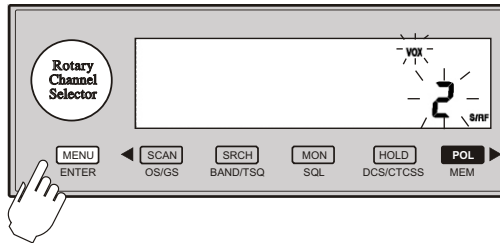

NOTE

If a button is not pressed within 10 seconds the uh015sx will automatically exit Select Mode.

Programming the Instant Priority Channel

Turn the Rotary Channel Selector to select the Priority Channel you prefer. Press and hold **[INST]** for 2 seconds to store the new setting. **INST** icon appears.

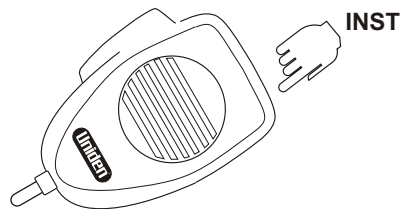

Recalling the Instant Channel

Momentarily press **[INST]** to return to the Instant Channel.

Operation

CTCSS (Continuous Tone Coded Squelch System)

This feature allows you to receive signals only from callers who have selected the same CTCSS code.

Turn the Rotary Channel Selector to select the channel you want to set a CTCSS code.
Press and hold **[HOLD]** /CTCSS/DCS.

The CTCSS channel display will flash.
Turn the rotary knob to select a desired CTCSS code.

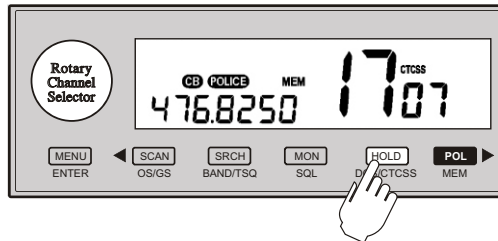

Press **[HOLD]** to set the code. When a code other than oF is selected, the CTCSS icon and code will display. If there is no selection for 10 seconds, the operation is timed out.

DCS (Digitally Coded Squelch)

DCS is a digital extension of CTCSS. It provides 104 extra, digitally coded, squelch codes that follow after the 38 CTCSS codes. CTCSS 1-38, followed by DCS 1-99 plus DCS 100-104 (represented by o0-o4 on the display).

Follow the steps for setting a CTCSS code. Turn the Rotary Channel Selector until the DCS codes appear. Press **[HOLD]** to set. The **DCS** icon and code will display.

NOTE

Channels 5 and 35 are used for emergency channels. CTCSS and DCS will not operate on these channels.

Selective Calling

Outline

Selective Calling (Selcall) is a special Sequential Tone Squelch System that allows the user to receive/transmit calls selectively from/to an individual or group, on a shared busy channel.

The uh015sx has a Selective Calling system. Exceptional features, like Receiver Quieting, Tone Squelch Scanning, Tone and Group Calling make the uh015sx superior to any transceivers in its class.

Receiver Quieting (Tone Squelch)

When activated, it automatically mutes the receiver audio circuit of the radio. It will stay in this Quiet mode as long as the Selcall tone code (Selcall ID) required to open the muting circuit is not received.

Call Alarm

When a received code matches to your Selcall ID, an alarm (CA Alert) will be emitted informing you that a caller is on the channel.

Tone Squelch Scanning

Scans only tone squelched Channels.

Tone Calling

Allows you to selectively call another radio.

Group Calling Capability

Transmits and Responds to Group Calls.

Receiver Quieting

Puts the receiver in the QUIET mode (also known as the Tone Squelch mode). When activated, the transceiver prevents any unwanted conversations in the channels from being heard unless the call is specifically directed to you and the Selcall ID required to open the QUIET condition has been received. Under this condition, the PTT button is temporarily disabled. If you wish to use the same Channel for normal communication, simply remove the Channel from QUIET mode.

Selective Calling

To Activate:

1. Select the channel you want to put in 'QUIET' mode using the Channel selector.
2. Press and hold **[SRCH]** /TSQ for 2 seconds. Two beeps are heard and the **TSQ** icon appears on the LCD display.

To Deactivate the Quiet Condition:

1. Select the Tone squelched Channel using the Channel Selector.
2. Press and hold **[SRCH]** /TSQ for 2 seconds. Two beeps are heard and the **TSQ** icon disappears from the LCD display.

Call Receiving

While in TSQ condition, when uh015sx receives a code matching your Selcall ID, it will perform the following operations.

- a) Automatically responds to the caller by transmitting Acknowledge Tones.
- b) Informs you that a caller is on the Channel by emitting a CALL ALARM (Default Alarm Setting: *four successive beeps in a regular interval for 10 seconds. Refer to page 32, 'Alarm Mode' for other alarm settings*) and displays the **CAL** icon.
- c) Flashes the **TSQ** icon for about 20 seconds allowing you to use the PTT button. If you are not able to respond within the 20 second period, **TSQ** icon stops flashing and 'QUIET' mode resumes.

NOTE

The uh015sx can decode a Selcall call even though not in 'QUIET' mode.

Selective Calling

Tone Squelch Scanning

If you are using two or more Channels in the TSQ mode, you can monitor all of these Channels for selective calls by using the TSQ scanning feature.

To use this feature start the TSQ Scan by pressing and holding **[SRCH]** /TSQ for 2 seconds during Open Scan or Group Scan.

Unlike Normal Scanning, TSQ scans and checks detected signals for Selcall information. If this information is not found, TSQ Scanning resumes.

When a call is received during TSQ Scanning, uh015sx follows the same response as when receiving a call on a Tone Squelch Channel. It differs only in the following ways:

1. If the call is not answered within 20 seconds, TSQ Scanning resumes. The **CAL** icon remains on the LCD display. To look for the Channel where the CALL is received.
 - a) Cancel TSQ Scanning by pressing **[SCAN]**.
 - b) Using the Channel Selector, browse through the TSQ Channels. The **CAL** indicator marks the Channel where the Call is received.
2. When answered, TSQ Scanning is automatically deactivated. The Channel is removed from the QUIET Operating Mode. To deactivate TSQ Scanning:
 - a) Press and hold **[SRCH]** /TSQ for 2 seconds. The unit returns to Normal Scanning Mode.
 - b) Press **[SCAN]**. The whole scanning operation is cleared.
 - c) When a Selcall is received, press the **PTT** button.

NOTE

The chance of receiving and decoding Selcalls effectively during TSQ Scanning can be increased in many different ways. You can either decrease the number of channels to be scanned thus increasing the scanning speed – or – change some of the Selcall parameters (refer to 'Selcall Programming').

Tone Calling

Tone Calling allows you to selectively call other radios.

To do this, the Selcall ID of the radio you are going to call should be in the transmitter's Selcall ID memory (refer to '5/6 TX Tone Selcall Programming' page 21).

To Call:

1. Select the channel that you and your group agreed to use for Selective Calling.
2. Press and hold **(TCAL)** for 2 seconds. A beep tone will be heard and the **CAL** indicator will appear on the LCD display while the Selcall ID is being transmitted automatically.

An acknowledge tone coming from the called radio will be received if you have successfully made contact. The acknowledge tone for the uh015sx is a succession of three low tone beeps.

Selective Calling

5/6 TX Tone Selcall Programming

1. Press **(TCAL)**.
The TX Selcall Code will be displayed. (factory default :00000)



Use **(SCAN)** or **(POL)** to select the digit position.
The selected digit will flash.

Rotate the Channel Selector to change the active digit value.
When finished, transmit the TX Selcall Code by pressing the microphone **(TCAL)** button for 2 seconds.

2. Selecting 5 or 6 Tone Format.
From 5 or 6 Tone Format Setting

While the 5th digit is flashing, press **(POL)**.
A space bar [_] will appear and flash.



Assign a Selcall number to this position using the Channel Selector.
When finished, transmit the TX Selcall code by pressing the **(TCAL)** for 2 seconds.

Selective Calling

Group Calling

The uh015sx has the capability to respond to Group Calling and to transmit Group Calling Codes.

Group Calling allows you to call members of your group simultaneously. However, to do this, you need to follow a certain format when programming your TX Selcall ID.

TX Selcall ID Format

To call	Transmitter SELCALL ID
10 radios	[X] [X] [X] [X] [A]
100 radios	[X] [X] [X] [A] [A]
1000 radios	[X] [X] [A] [A] [A]
10000 radios	[X] [A] [A] [A] [A]

where: [X] is a common Selcall ID prefix of your group
 - and - [A] is the CCIR Assigned Group Tone Code

Example:

If one group comprises 10 members with Selcall IDs the ID numbers could be as follows -

Group ID #	Individual ID#
[1] [2] [3] [4]	[0]
[1] [2] [3] [4]	[1]
[1] [2] [3] [4]	[2]
[1] [2] [3] [4]	[3]

to -

[1] [2] [3] [4] [9]

all in TSQ mode at CH20

If someone transmits [1] [2] [3] [4] [A] on CH20, all of the above units will open their Tone Squelched Receiver.

Group Calls and ordinary Selcalls can be differentiated in the following manner:

Group Call -	Low tone beeps
Ordinary Selcall -	High tone beeps



Acknowledge tones will not be received when a Group Call code is transmitted. If all radios respond, acknowledge tones would only 'litter' the channel with crisscrossing signals.

5/6 Tone Selcall Programming

Since uh015sx can support either a 5 or 6 tone signalling format, you and your group must decide which format to use. The following is a basic outline of Selcall Programming.

Press and hold **MENU** then turn power on.

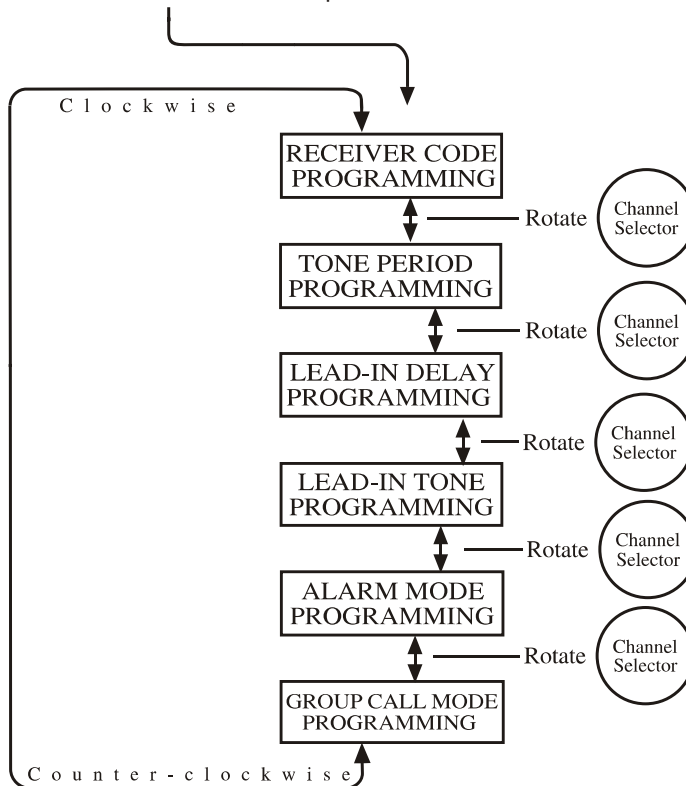

To edit any option, press **MENU**/ENTER.

To cancel any setting, momentarily press **SRCH** once.

To save a new setting after programming, press and hold **MENU**/ENTER for 2 seconds. The store confirmation tone will be heard and the unit returns to Normal Operating Mode.

Receiver Selcall ID

Programming Your Selcall ID.

To programme your own receiver Selcall ID.

1. Press and hold **MENU** then turn power on.
2. The initial display and status will appear on the screen (factory default is 00000).

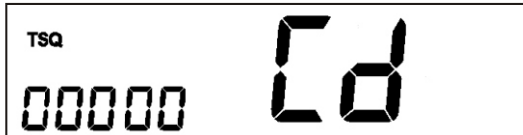

3. When the **MENU** key is pressed while in this condition, the last digit will begin to flash.



4. Use **◀ SCAN** or **POL ▶** to select the digit position. The selected digit will flash.
5. Rotate the Channel Selector to change the active digit value.
6. When finished, press **MENU** / **ENTER** to store. Three successive beeps are heard.
7. Press **MENU** / **ENTER** for 2 seconds to exit. The radio returns to normal operation.

-or-

Turn the Channel Selector to go to the next programmable parameter.

Receiver Selcall ID

Selecting 5 or 6 Tone Format From 5 to 6 Tone Format

1. While the 5th digit is flashing, press **[POL]** ► . A space bar [_] will appear and flash.



2. Assign a Selcall number on this position.
3. Rotate the Channel Selector to change the active digit value.
4. When finished, press **[MENU]** /ENTER to store. Three successive beeps are heard.
5. Press **[MENU]** /ENTER for 2 seconds to exit. The radio returns to normal operation.

-or-

Turn the Channel Selector to go to the next programmable parameter.

From 6 to 5 Tone Format setting

1. Select the 6th digit position using **[SCAN]** ◀ and **[POL]** ► and change its setting from the assigned number to a space bar [_] using the Channel Selector.

Example:



Receiver Selcall ID



2. When finished, press **MENU** /ENTER to store. Three successive beeps are heard.
3. Press **MENU**/ENTER for 2 seconds to exit. The radio returns to normal operation.

-or-

Turn the Channel Selector to go to the next programmable parameter.

Other Selcall Parameters

You should also be familiar with some of the other Selcall parameters. This section outlines the following programming modes.

- Tone Period
- Lead-in delay
- Lead-in Tone
- Alarm Mode
- Group Call Mode

Selcall ID

Tone Period

Tone period is the duration of one tone in a Selcall ID sequence. The setting of this parameter depends on the type of application. On long distance communications, for example: where the signal strength of the transmitted information is greatly reduced and affected by noise, it is advisable to use a longer Tone Period. A long Tone Period gives the decoder more time and information to check and evaluate the code.



However, be sure that all the radios in your group use the same Tone Period setting. Otherwise you will not be able to selectively call one another.

The uh015sx allows you to select which Tone Period is best for you. The three most commonly used tone settings (40,70 or 100 mSec) are available. With the freedom to change this parameter, you can easily adapt to the existing system in your group without the inconvenience of having the unit serviced by the dealer.

1. Press and hold **MENU** then turn power on. Rotate the Channel Selector until **Pd** is displayed.



2. Press **MENU** /ENTER and **040** (factory default setting) will flash and Tone Period editing is possible.



3. Rotate the Channel Selector to change the Tone Period value.

Selcall ID

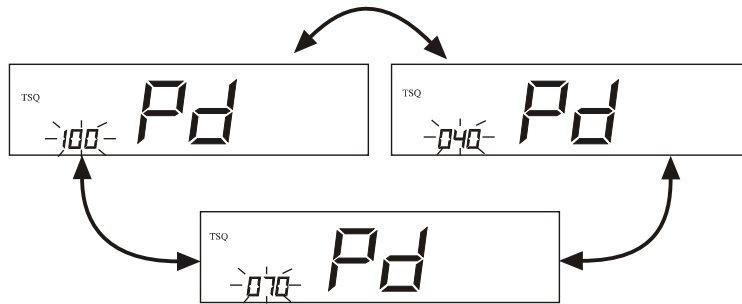

4. When finished, press **[MENU]** /ENTER to store. Three successive beeps are heard.
5. Press **[MENU]** /ENTER for 2 seconds to exit. The radio returns to normal operation.

-or-

Turn the channel selector to go to the next programmable parameter.

Lead-in Delay

Lead-in delay is a Selcall transmission parameter that 'wakes-up' and helps the receiver of the other radio to lock onto the incoming signal. Each time a Selcall ID is transmitted, the Lead-in Delay attaches itself to the beginning of the code sequence and causes the transmitter to be on for a longer period prior to the code transmission. This makes for a stronger communication link between the transmitter and the other receiver.

One major advantage to having the longer Lead-in Delay is when selectively calling another radio via a repeater station. A longer Lead-in Delay helps to stabilise both the communication link from your radio to the repeater station and from the repeater station to the other radio.

Selcall ID

Lead-in Delay Programming

1. Press and hold **[MENU]** then turn power on. Rotate the Channel Selector until is displayed. **Ld**



500 mSec is the factory default setting of uh015sx for Lead-in Delay.

2. Press **[MENU]** /ENTER and Lead-in Delay Editing is possible. Use the Channel Selector to change the Lead-in delay value.

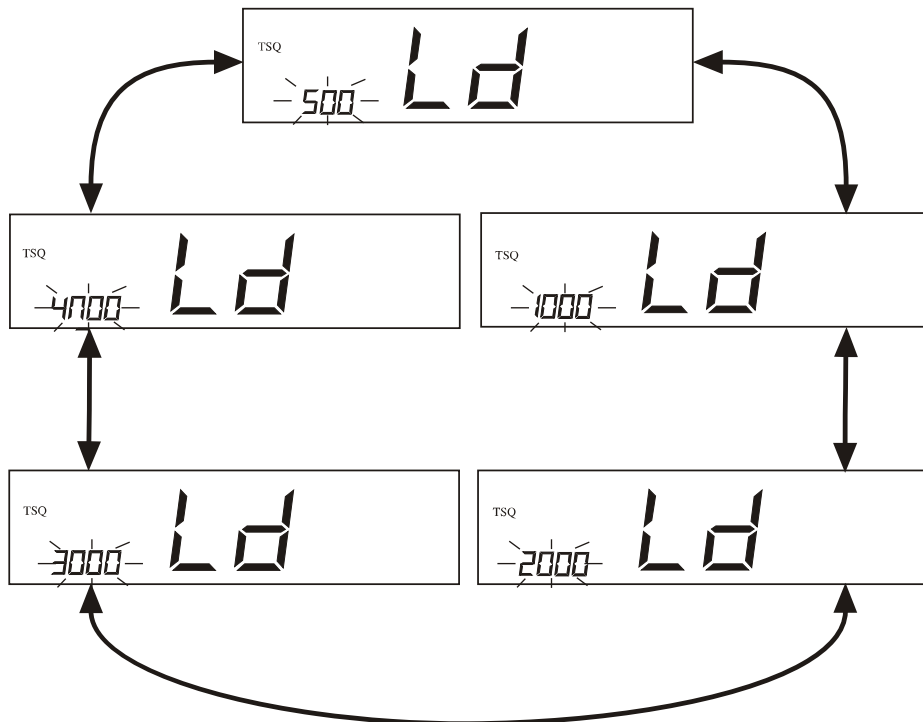

Selcall ID

3. When finished, press **[MENU]** /ENTER to store. Three successive beeps are heard.
4. Press **[MENU]** /ENTER for 2 seconds to exit. The radio returns to normal operation.
-or-
Turn the Channel Selector to go to the next programmable parameter.

Lead-in Tone

The Lead-in Tone, when programmed, 'rides' on the Lead-in Delay.

Hence, when transmitting a Selcall ID, a continuous tone will be heard for the duration of the Lead-in Delay.

The main purpose of the Lead-in Tone is to increase the probability of contact between your unit and another radio when TSQ Scanning.

1. Press and hold **[MENU]** then turn power on.
Rotate the Channel Selector until **LF** is displayed.



Tone _ 1 is the factory default setting of the uh015sx for Lead-in Tone.

2. Press **[MENU]** /ENTER and Lead-in Tone Editing is possible.



Use the Channel Selector to change the Lead-in Tone value.

Selcall ID

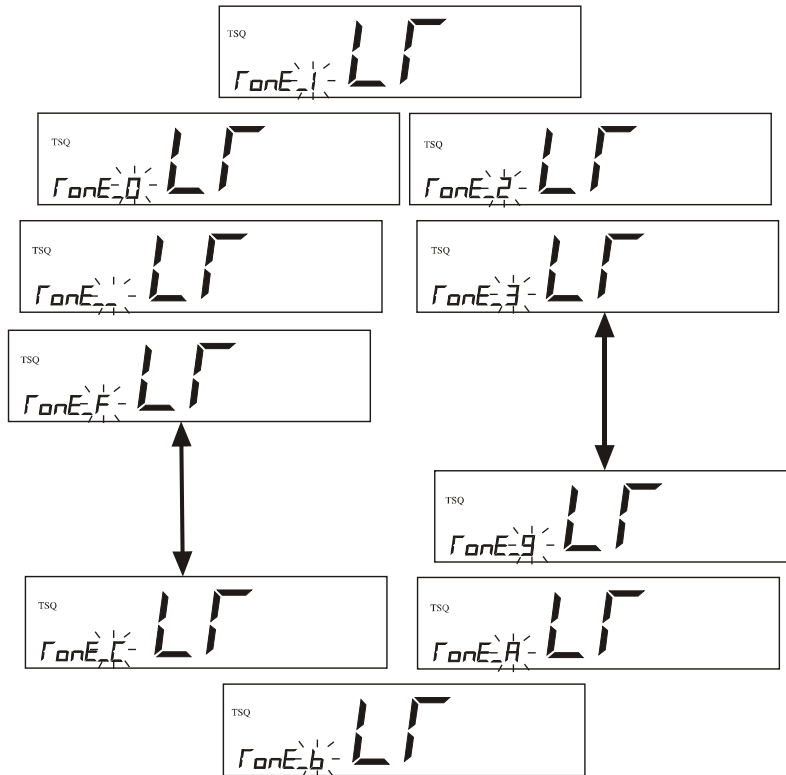

NOTE

If you want to remove the Lead-in Tone choose the space [_] Bar.

3. When finished, press **[MENU]** /ENTER to store. Three successive beeps are heard.
4. Press **[MENU]** /ENTER for 2 seconds to exit. The radio returns to normal operation.

-or-

Turn the Channel Selector to go to the next programmable parameter.

NOTE

Make sure that all members of your group use the same Lead-in Tone. Otherwise, you will lessen the probability of receiving and successfully decoding a Selcall while TSQ scanning.

Alarm Mode

Alarm Mode

When a received code matches to your receiver Selcall ID and you selected the Call Alarm Auto Mode the Unit will:

- a. Transmit an Acknowledge tone to the Caller.
- b. Emit CALL Alarm for 10 seconds only.
- c. Resume Quiet condition automatically after 20 seconds if the call is not answered.
- d. The Unit will start decoding again when the 20 second period elapsed and the call remained unanswered.

Call Alarm Continue Mode

- a. The Unit will transmit an Acknowledge Tone to the Caller.
- b. Initially an alarm of four successive beeps is emitted for 20 seconds and then two successive beeps every four seconds continuously unless answered.
- c. The Quiet Condition is never resumed.
- d. The Unit continues to check if incoming codes have your Receiver Selcall ID even though the Quiet Condition is already opened.
When detected, it will send an acknowledge Tone to the caller and then resets the Call Alarm.

NOTE

*For both of the above mentioned modes, transmission by using the Press-to-Talk button is possible when the **TSQ** icon is flashing.*

1. Press and hold **MENU** then turn on the power. Rotate the Channel Selector until **AL** is displayed.



Alarm Mode

2. Press **[MENU]** /ENTER and Alarm mode editing is possible.



Call Alarm Continuous Mode



Call Alarm Auto Off Mode



Alarm Mode

3. Use the Channel Selector to change the Alarm mode.
4. When finished, press **MENU**/ENTER to store. Three successive beeps are heard.
5. Press **MENU** /ENTER for 2 seconds to exit. The radio returns to normal operation.

-or-

Turn the Channel Selector to go to the next programmable parameter.

Group Call Mode

Group 01 mode sets the tone period to 1 tone period.
Group 02 mode sets the first group tone period to 3 tone periods.

1. Press and hold **MENU** then turn power on. Rotate the Channel Selector until **01** (or 02) is displayed.



2. Press **MENU**/ENTER and Group mode editing is possible.
3. Use the Channel Selector to change the Group mode.

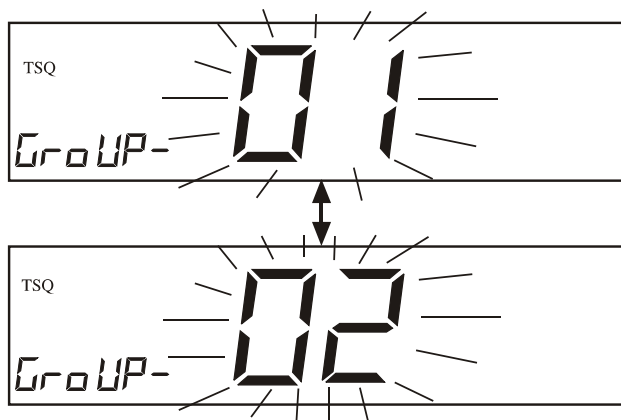

Group Call Mode

4. When finished, press **[MENU]**/ENTER to store. Three successive beeps are heard.
5. Press **[MENU]**/ENTER for 2 seconds to exit. The radio returns to normal operation.
-or-
Turn the Channel Selector to go to the next programmable parameter.

Default Settings

- A. RX Selcall ID : 00000
- B. TX Selcall ID : 00000
- C. Tone Period : 40mSec
- D. Lead-in Delay : 500mSec
- E. Lead-in Tone : Tone '1'
- F. Alarm Mode : Auto
- G. Group Call Mode : 01



Be sure that the Tone Format (5 Tone or 6 Tone), Tone Period Setting and the Lead-in Tone for all radios in your group are the same. Otherwise you will not be able to effectively call one another.

Selcall Tone Frequency List

TONE No.	TONE FREQUENCY (Hz)	TONE No.	TONE FREQUENCY (Hz)
0	1981	8	1747
1	1124	9	1860
2	1197	A (Group)	2400
3	1275	B	930
4	1358	C	2247
5	1446	D	991
6	1540	E (Repeat)	2110
7	1640	F	1055

UHF CB Channels & Frequencies

NOTE
Please follow these guidelines for channel use in Australia:

- Channels 05 and 35 are Emergency Channels.
- Channel 11 is a Calling Channel.
- Channels 22 and 23 are for telemetry and telecommand applications and TX is inhibited on these channels.

General communication is accepted on all other channels with these guidelines:

- Channel 40 - road channel (Australia).
- Channels 01-08 (and 31-38) are repeater channels.

CH No.	Simplex Mode Transmit / Receive Frequency (MHz)	Duplex Mode Transmit Frequency (MHz)	CH No.	Simplex Mode Transmit/Receive Frequency (Mhz)
1	476.425	477.175 CH31	21	476.925
2	476.450	477.200 CH32	22	476.950 (RX only)
3	476.475	477.225 CH33	23	476.975 (RX only)
4	476.500	477.250 CH34	24	477.000
5	476.525	477.275 CH35	25	477.025
6	476.550	477.300 CH36	26	477.050
7	476.575	477.325 CH37	27	477.075
8	476.600	477.350 CH38	28	477.100
9	476.625		29	477.125
10	476.650		30	477.150
11	476.675		31	477.175
12	476.700		32	477.200
13	476.725		33	477.225
14	476.750		34	477.250
15	476.775		35	477.275
16	476.800		36	477.300
17	476.825		37	477.325
18	476.850		38	477.350
19	476.875		39	477.375
20	476.900		40	477.400

CTCSS & DCS Code List

CTCSS Code LIST

Code No.	Frequency (Hz)	Code No.	Frequency (Hz)	Code No.	Frequency (Hz)
"oF"	OFF	13	103.5	26	162.2
1	67.0	14	107.2	27	167.9
2	71.9	15	110.9	28	173.8
3	74.4	16	114.8	29	179.9
4	77.0	17	118.8	30	186.2
5	79.7	18	123.0	31	192.8
6	82.5	19	127.3	32	203.5
7	85.4	20	131.8	33	210.7
8	88.5	21	136.5	34	218.1
9	91.5	22	141.3	35	225.7
10	94.8	23	146.2	36	233.6
11	97.4	24	151.4	37	241.8
12	100.0	25	156.7	38	250.3

DCS Code LIST

Code No.	DCS Code (Octal)	Code No.	DCS Code (Octal)	Code No.	DCS Code (Octal)	Code No.	DCS Code (Octal)
1	023	27	152	53	311	79	466
2	025	28	155	54	315	80	503
3	026	29	156	55	325	81	506
4	031	30	162	56	331	82	516
5	032	31	165	57	332	83	523
6	036	32	172	58	343	84	526
7	043	33	174	59	346	85	532
8	047	34	205	60	351	86	546
9	051	35	212	61	356	87	565
10	053	36	223	62	364	88	606
11	054	37	225	63	365	89	612
12	065	38	226	64	371	90	624
13	071	39	243	65	411	91	627
14	072	40	244	66	412	92	631
15	073	41	245	67	413	93	632
16	074	42	246	68	423	94	654
17	114	43	251	69	431	95	662
18	115	44	252	70	432	96	664
19	116	45	255	71	445	97	703
20	122	46	261	72	446	98	712
21	125	47	263	73	452	99	723
22	131	48	265	74	454	100(o0)	731
23	132	49	266	75	455	101(o1)	732
24	134	50	271	76	462	102(o2)	734
25	143	51	274	77	464	103(o3)	743
26	145	52	306	78	465	104(o4)	754

Warranty

UNIDEN UH015SX UHF CB TRANSCEIVER RADIO

Limited Two Year Warranty

NOTE

Please keep your sales docket as it provides evidence of warranty.

Warrantor: Uniden Australia Pty Limited ABN 58 001 865 498

Uniden New Zealand Limited

Warranty only available in original country of purchase

Elements of Warranty: Uniden warrants to the original retail owner for the duration of this warranty, its uh015sx UHF CB Radio (hereinafter referred to as the Product) to be free from defects in materials and craftsmanship with only the limitations or exclusions set out below.

Warranty Duration: This warranty to the original retail owner only, shall terminate and be of no further effect TWO (2) years after the date of original retail sale. This warranty will be deemed invalid if the Product is;

- (A) Damaged or not maintained as reasonable and necessary,
- (B) Modified, altered or used as part of any conversion kits, subassemblies, or any configurations not sold by Uniden,
- (C) Improperly installed,
- (D) Repaired by someone other than an authorized Uniden Repair Agent for a defect or malfunction covered by this warranty,
- (E) Used in conjunction with any equipment or parts or as part of a system not manufactured by Uniden, or
- (F) Where the Serial Number label of the product has been removed or damaged beyond recognition.

Warranty only valid in the country of original retail/sale.

Parts Covered: This warranty covers for two (2) years, the Product and included accessories.

Statement of Remedy: In the event that the Product does not conform to this warranty at any time while this warranty is in effect, the warrantor at its discretion, will repair the defect or replace the Product and return it to you without charge for parts or service. This warranty does not provide for reimbursement or payment of incidental or consequential damages.

This EXPRESS WARRANTY is in addition to and does not in any way affect your rights under the TRADE PRACTICES ACT 1974 (Cth) (Australia) or the CONSUMER GUARANTEES ACT (New Zealand).

Procedure for obtaining performance or warranty: In the event that the Product does not conform to this warranty, the Product should be shipped or delivered, freight prepaid, with evidence of original purchase, (eg. a copy of the sales docket), to the warrantor at:

UNIDEN AUSTRALIA PTY LTD

Service Division
345 Princes Highway,
Rockdale, NSW 2216
Fax (02) 9599 3278
www.uniden.com.au

UNIDEN NEW ZEALAND LTD

Service Division
150 Harris Road, East Tamaki,
Auckland
Fax (09) 274 4253
www.uniden.co.nz

Uniden®

© 2007 Uniden Australia Pty Limited/Uniden New Zealand Limited
Printed in China UTZZ01931ZB(0)

Free Manuals Download Website

<http://myh66.com>

<http://usermanuals.us>

<http://www.somanuals.com>

<http://www.4manuals.cc>

<http://www.manual-lib.com>

<http://www.404manual.com>

<http://www.luxmanual.com>

<http://aubethermostatmanual.com>

Golf course search by state

<http://golfingnear.com>

Email search by domain

<http://emailbydomain.com>

Auto manuals search

<http://auto.somanuals.com>

TV manuals search

<http://tv.somanuals.com>