

BC60XLT



*Programmable
Hand-Held
Scanner*

OPERATING GUIDE

PRECAUTIONS

Before you use this scanner, please read and observe the following:

■ **WARNING!**

Uniden **DOES NOT** represent this unit to be waterproof. To reduce the risk of fire or electrical shock, **DO NOT** expose this unit to rain or moisture.

■ **EARPHONE WARNING:**

- Be sure to use only the recommended optional earphone or a stereo headset of the proper impedance (32Ω). Use of an incorrect earphone or stereo headset may be potentially hazardous to your hearing. The output of the Phone jack is monaural, but you will hear it in both headphones of a stereo headset.
- Set the Volume to a comfortable audio level coming from the speaker before plugging in an earphone or a stereo headset of the proper impedance (32Ω). Otherwise you might experience some discomfort or possible hearing damage if the Volume suddenly becomes too loud because of the Volume Control or Squelch Control setting. This may be particularly true of the type of earphone that is placed in the ear canal.

■ **GENERAL BATTERY WARNING**

- Do not short circuit any Battery.
- Do not discard Batteries in a fire; they may explode.

■ **NICKEL-CADMIUM BATTERY WARNING**

When using Nickel-Cadmium Batteries with this product, take note of the following warnings:

- Cadmium is a chemical known to the State of California to cause cancer.
- Do not charge Nickel-Cadmium Batteries with any charger other than the one supplied with this product. Using another charger may damage the Batteries, or cause them to explode.
- Nickel-Cadmium Batteries must be disposed of properly. Read the Nickel-Cadmium Battery Disposal package insert for important information.

■ **ALKALINE BATTERY WARNING**

- Do not recharge Alkaline Batteries in this product. Doing so may cause serious damage to the product and will void the warranty.
- Uniden does not recommend using rechargeable Alkaline Batteries in this product.

Controls

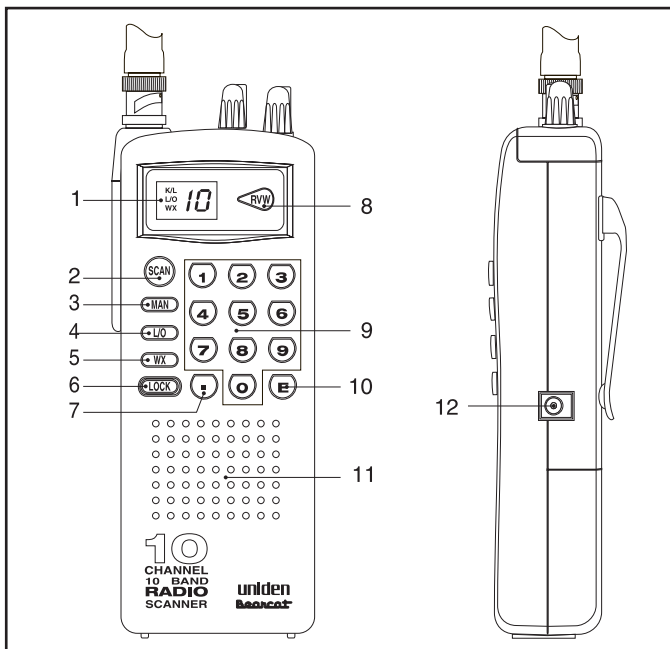

- | | |
|---------------------|-----------------------|
| 1. LCD Display | 7. Decimal Key |
| 2. Scan Key | 8. Review Key |
| 3. Manual Key | 9. Numeric Key Pad |
| 4. Lockout Key | 10. Enter Key |
| 5. Weather Scan Key | 11. Speaker |
| 6. Keylock Key | 12. 12V DC Power Jack |

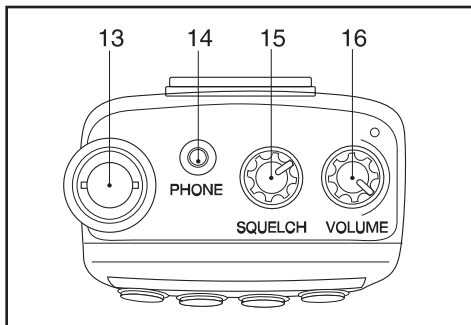

- | | |
|-----------------------|---------------------------|
| 13. Antenna Connector | 15. Squelch Control |
| 14. Phone Jack | 16. On/Off Volume Control |

Table of Contents

About Your New BC60XLT	2
Feature Highlights	2
What is Scanning?	2
Types of Communication	3
Included with the BC60XLT	4
Where to Obtain More Information	5
Setup	6
Power	6
Installing Batteries	6
AC/DC Adapter/Charger	7
Mounting the Flexible Antenna	7
Installing the Belt Clip	7
Operation	8
Keylock	8
Programming Channels	9
How Squelch Works	12
Setting the Squelch	13
Scanning Programmed Channels	13
Channel Lockout	16
Scanning Weather Channels	18
Care and Maintenance	20
Low Battery Warning	20
Replacing the Batteries	20
Location	20
Cleaning	20
Repairs	20
Proper Care of Your Scanner	20
Optional Accessories and Replacement Parts	21
Operating Tips	22
Technical Specifications	24
Controls	Back Cover Foldout

About Your New BC60XLT

The **BC60XLT** is a brand new state-of-the-art information radio with automatic scanning capabilities. It can store frequencies such as police, fire/emergency, marine, amateur, and other communications into 10 channels.

Feature Highlights

10 Channels Program one frequency in each channel. You must have at least one channel programmed to use this scanner.

10 Bands, 29 MHz - 512 MHz Scan these frequency ranges with your scanner. (**Note:** The frequency coverage is not totally continuous from 29.0 MHz to 512 MHz.)

Weather Channels Use your scanner as a weather information radio.

Memory Backup Frequencies programmed in the channels are retained in memory for at least 1 day, and typically 3 days, when batteries are removed from the scanner.

What is Scanning?

Unlike standard AM or FM radio stations, most two-way communications (listed below) do not transmit continuously. The **BC60XLT** scans programmed channels at the rate of nearly 10 channels per second until it finds an active frequency.

Scanning stops on an active frequency, and remains on that channel as long as the transmission continues. When the transmission ends, the scanner stays on the channel for 2 more seconds after the transmission stops, waiting for another transmission. The scanning cycle then resumes until another transmission is received.

While the **BC60XLT** is scanning channels, it is in "SCAN Mode". When you stop the scanning with **MANUAL**, it is in "MANUAL Mode".

Types of Communication

You will be able to monitor communication such as:

- Police and fire department (including rescue and paramedics)
- NOAA weather broadcasts (7 preprogrammed channels)
- Business/industrial radio
- Motion picture and press relay
- Utility
- Land transportation frequencies, such as trucking firms, buses, taxis, tow trucks, and railroads
- Marine and amateur (ham radio) bands

And many more in the following 10 Bands:

Frequency Range	Transmission
29.0-29.7 MHz	10 Meter Amateur Band
29.7-50.0 MHz	VHF Low band
50.0-54.0 MHz	6 Meter Amateur Band
137-144 MHz	Military Land mobile
144-148 MHz	2 Meter Amateur Band
148-174 MHz	VHF High Band
406-420 MHz	Federal Govt. Land Mobile
420-450 MHz	70 cm Amateur Band
450-470 MHz	UHF Standard Band
470-512 MHz	UHF "T" Band

NOTE:

The installation, possession, or use of this scanning radio in a motor vehicle may be prohibited, regulated, or require a permit in certain states, cities, and/or local jurisdiction. Your local law enforcement officials should be able to provide you with information regarding the laws in your community.

Included with the BC60XLT

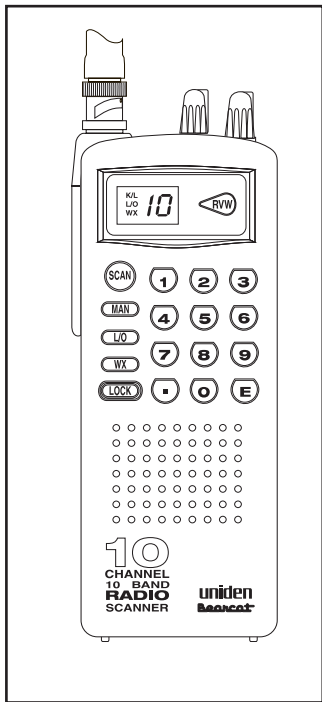

BC60XLT
Operating Guide
(OMBC60XKT)

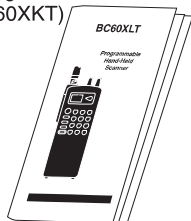

Belt Clip
with
Screws
(BCK150)



AC Adapter/Charger
(AD100U)

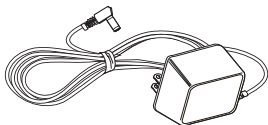

Rubber Antenna
(AT218)

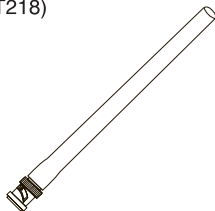

Betty Bearcat
Starter
Frequency
Guide
(BBSTARTUP)

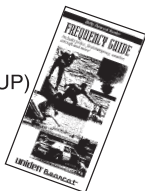

Other Printed
Information



Before you can scan, you must program a frequency into each channel you want to use. The Betty Bearcat Starter Frequency Guide lists typical frequencies used around the U.S. that you may use to program the **BC60XLT**.

If the frequencies listed do not work in your area, call the 800 number on the yellow sheet enclosed with the guide. A Uniden representative should be able to provide you with a few sample frequencies. Or, use the enclosed order form to purchase a local frequency list.

Where to Obtain More Information

The Bearcat Radio Club and other similar hobby clubs have publications, information on computer bulletin boards, and even contests for the radio enthusiast. Additional information is also available through your local library.

Please remove the Registration Card from the middle of this guide, complete, and mail it immediately.

Read this Operating Guide before using your **BC60XLT** for the first time.

Setup

Power

Installing Batteries

1. Open cover.

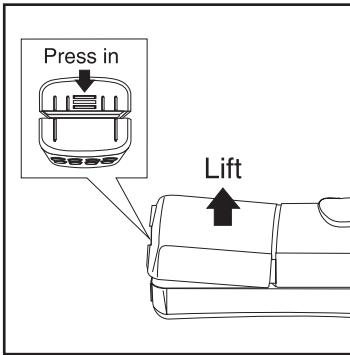

2. Insert batteries

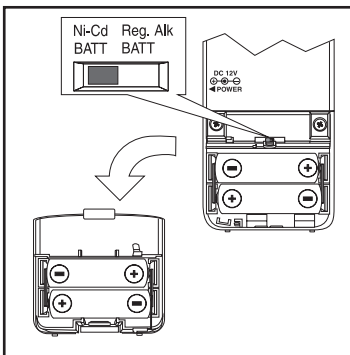

IMPORTANT

If you are installing Alkaline Batteries, set the switch to "Reg. Alk BATT." If installing Nickel-Cadmium Batteries, set the switch to "Ni-Cd BATT."

WARNING! Do not mix Alkaline Batteries with Nickel-Cadmium Batteries. Be sure to install four Batteries of the same type.

3. Replace cover.

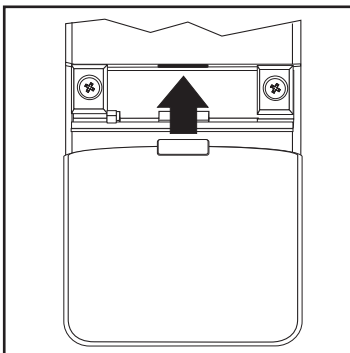

AC Adapter/Charger

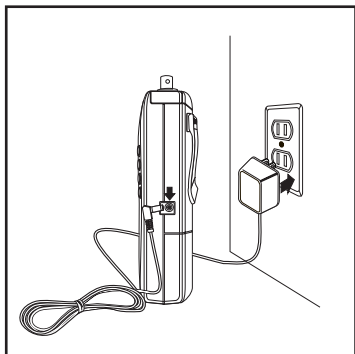

Use the included AC Adapter/Charger to power the **BC60XLT** from an AC source.
The AC Adapter/

Charger also recharges Nickel-Cadmium Batteries while they are installed in the scanner.

WARNING! Do not charge Alkaline Batteries in this scanner. Doing so may cause serious damage to the product and void the warranty. Before attempting to recharge Batteries, make sure you have installed four rechargeable Nickel-Cadmium Batteries and the selector switch is set to "Ni-Cd" .

Mounting the Flexible Antenna

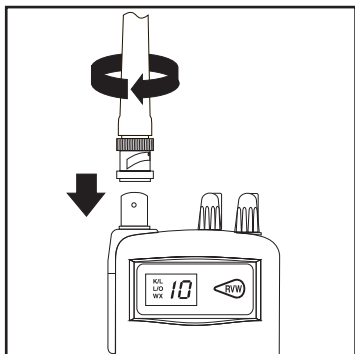

Installing the Belt Clip

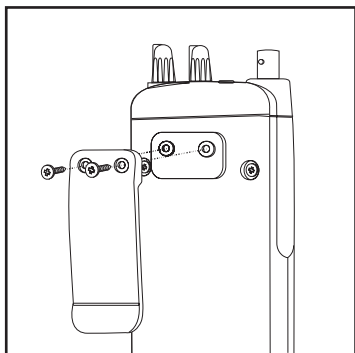

CAUTION: Do not tighten the screws too tight. You could damage the case or clip.

Operation

Keylock

Keylock prevents accidental key entries.

To lock:

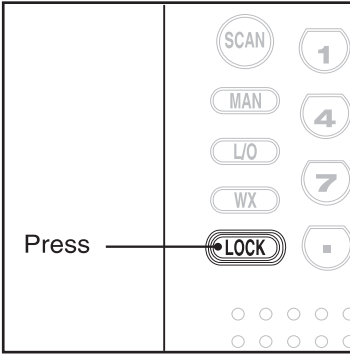

Only the **SCAN**, **MAN**, and **LOCK** keys will function.

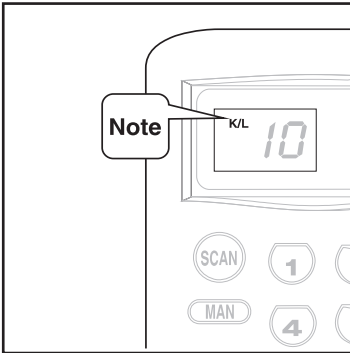

To unlock:

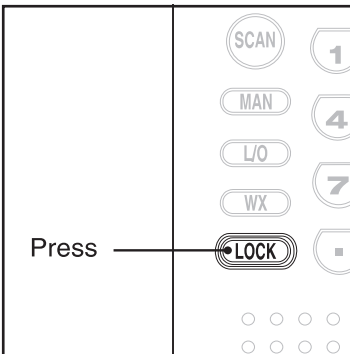

If keys do not work, press **LOCK** to unlock keys.

The **K/L** indicator disappears from the display.

Programming Channels

1. Select frequency.

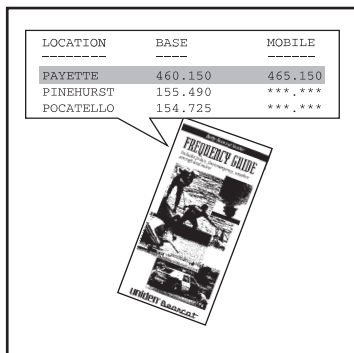

2. Select channel using Manual mode.

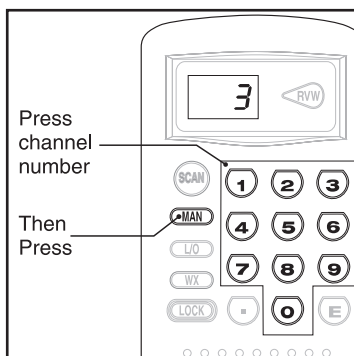
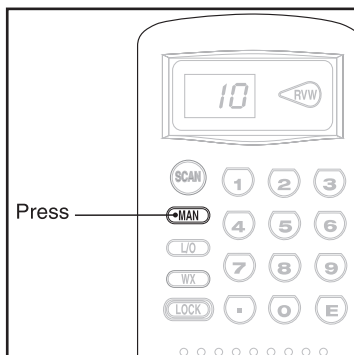

Note: For channel 10, press ①, ⑩.

— OR —

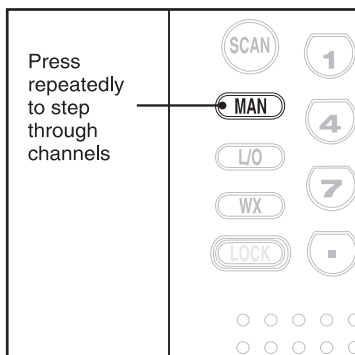

3. Enter frequency.

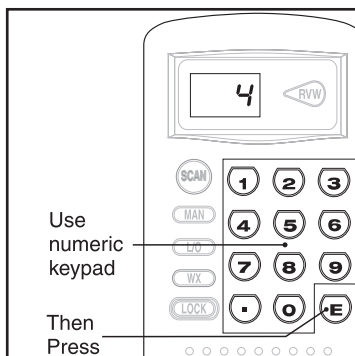

Each digit displays as you enter it.

The decimal displays as a dash.

If you make a mistake, press  twice and start over.

3a. If frequency outside range.

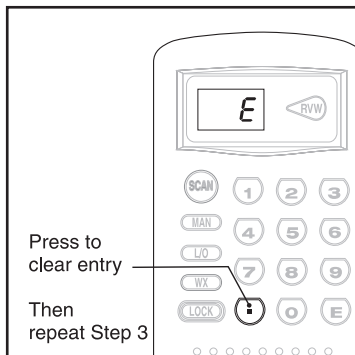

Programmed frequencies must be within the bands shown on the back of the scanner, and on page three of this guide.

4. Recheck frequency.

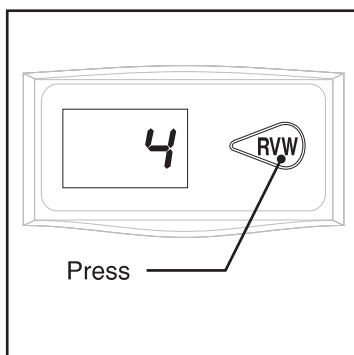

The frequency appears one digit at a time in sequence.

Repeat these steps to program each channel.

You can program the same frequency into two or more channels, if desired.

Channels with no frequency programmed are skipped during scanning.

After programming your scanner, record the frequencies in the table below (or another convenient place) so you can easily reprogram the scanner in case the memory is accidentally erased. Use pencil so you can change your entries at a later date.

Channel	Frequency	Notes
1		
2		
3		
4		
5		
6		
7		
8		
9		
10		

How Squelch Works

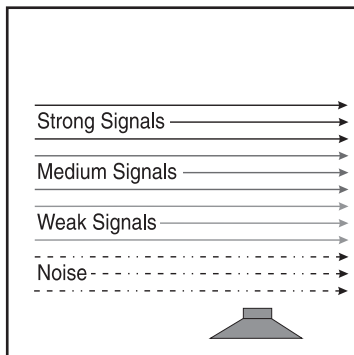

Think of "SQUELCH" as a gate.

If the gate is set too low (SQUELCH too low), everything (all noise as well as signals) gets through.

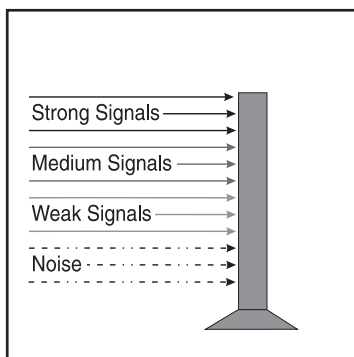

If the gate is set too high (SQUELCH too high), nothing gets through.

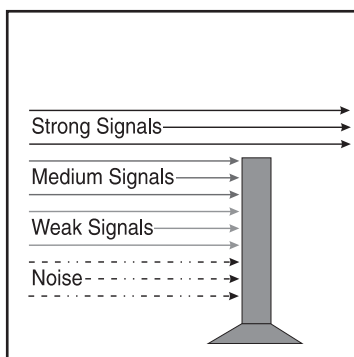

If the gate is set just right (SQUELCH set properly), just the desired signals get through.

Setting the Squelch

1. Turn until hiss heard.

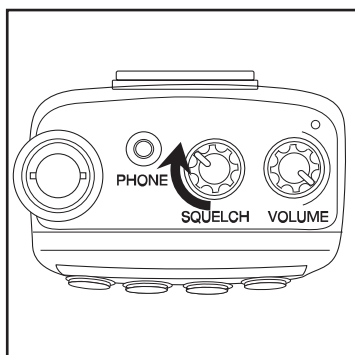

This action lowers the “squelch gate,” allowing all signals and noise to get through.

No signal should be present when adjusting squelch.

Scanner doesn't scan with squelch open.

2. Turn just until hiss stops.

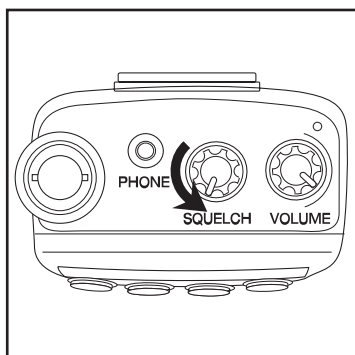

This action raises the “squelch gate,” allowing only strong signals to get through.

Scanner should begin scanning after two seconds.

Note: You must have at least one channel programmed before the **BC60XLT** will scan.

Scanning Programmed Channels

Turn the scanner on.

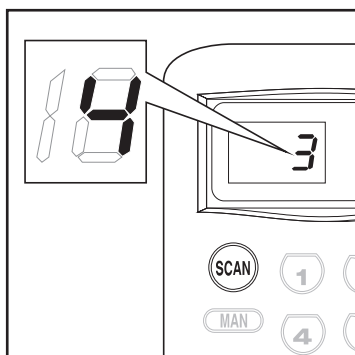

Channel numbers advance rapidly.

Note: When you turn the scanner on, it will always be in Scan mode.

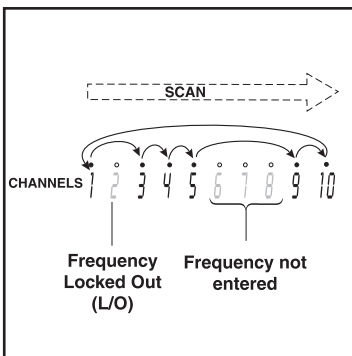

The scanner skips any unprogrammed channels, and locked out channels.

When transmission received:

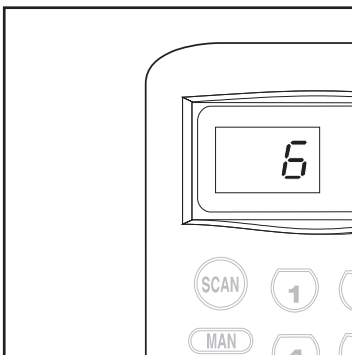

Scanner stops on that channel.

When the transmission ends, scanning resumes after a two second delay.

To hold on that channel:

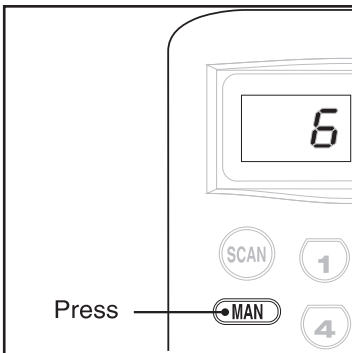

To resume scanning:

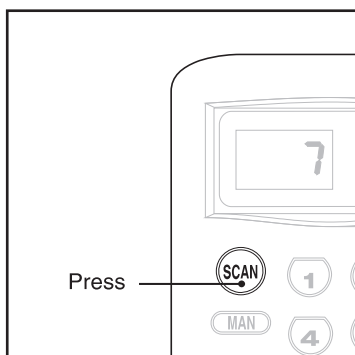

Scanner immediately resumes scanning.

To listen to or program a specific channel:

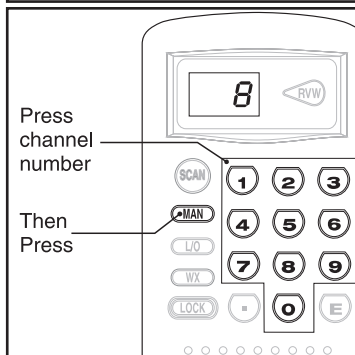
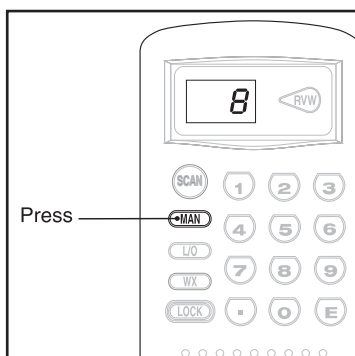

Note: For channel 10, press ①, ⑩.

Press **SCAN** to resume scanning.

Channel Lockout

Channel Lockout lets you skip channels during scanning. There are two ways to lock out a channel:

Manual Mode

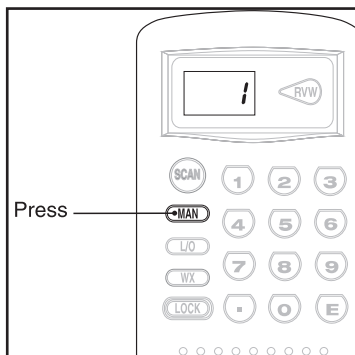

Use Manual mode to select the channel you want to lock out.

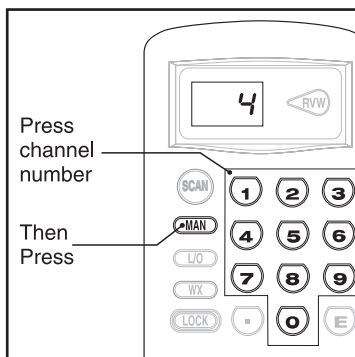

Note: For channel 10, press ①, ⑩.

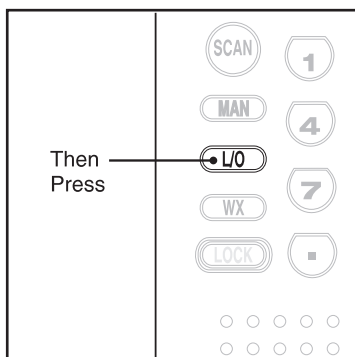

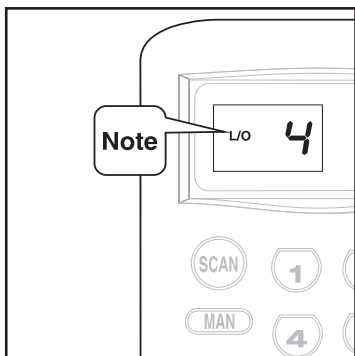

Scanning Mode

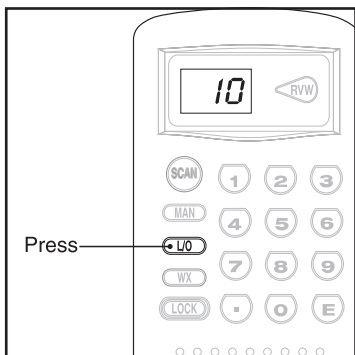

When the scanner stops on a channel during scanning, you can lock out that channel by pressing (L/O).

Because the locked out channel is no longer scanned, scanning resumes immediately after pressing (L/O).

To unlock a channel:

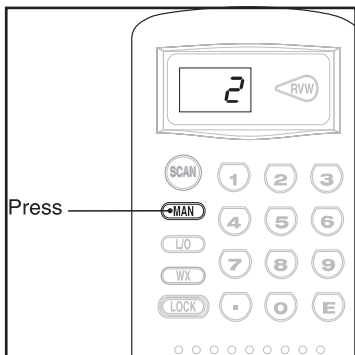

Use Manual mode to select the desired channel.

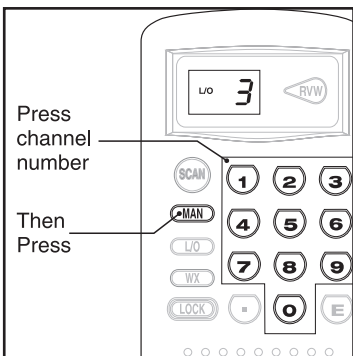

Note: For channel 10, press ①, ⑩.

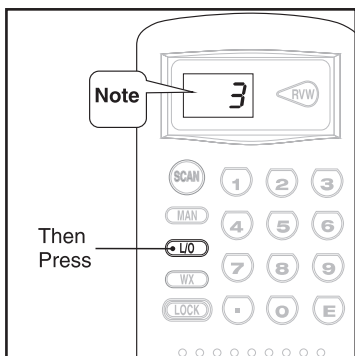

The **L/O** indicator disappears from the display after pressing ①⑩.

Scanning Weather Channels

To scan weather channels:

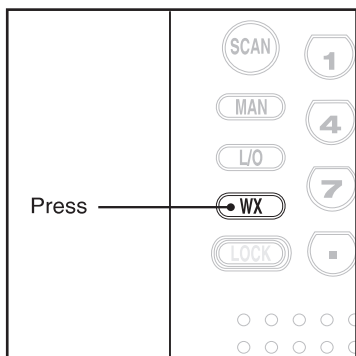

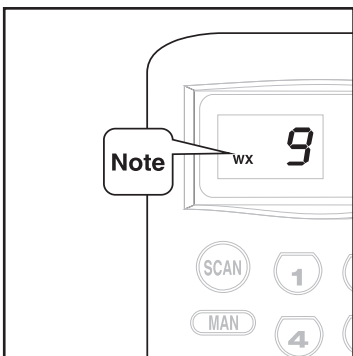

The **BC60XLT** finds the active weather channel in your area from seven preprogrammed NOAA frequencies.

Note: The channel number does not indicate the NOAA weather frequency you hear.

To review the weather frequency:

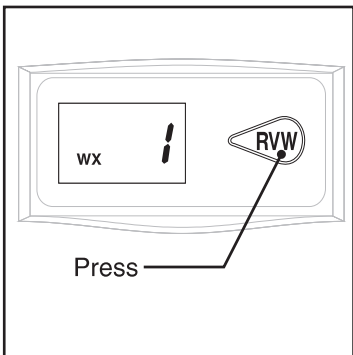

The frequency displays one digit at a time, in sequence.

To resume normal scanning:

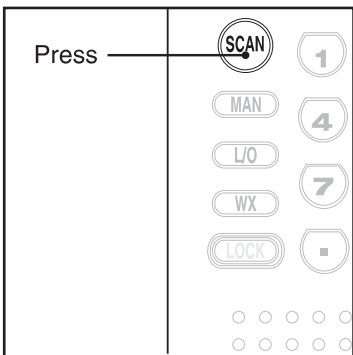

Care and Maintenance

Low Battery Warning

When the Batteries become weak, you will hear an audible warning. Be sure to replace Alkaline Batteries as soon as possible, or you can recharge Nickel-Cadmium Batteries while they are installed in the scanner.

Replacing the Batteries

See page six.

Location

- If strong interference or electrical noise is received, relocate the scanner or its antenna away from the source of the noise. A higher elevation, if possible, may provide better reception.
- **Do not** use the scanner in high-moisture environments such as the kitchen or bathroom.
- Avoid placing the unit in direct sunlight or near heating elements or vents.

Cleaning

- Disconnect the power to the unit before cleaning.
- Clean the outside of the scanner with a mild detergent.
- To prevent scratches, **do not** use abrasive cleaners or solvents. Be careful not to rub the LCD window.
- **Do not** use excessive amounts of water.

Repairs

Do not attempt any repair. The scanner contains no user serviceable parts. Contact the Uniden Customer Service Center or take it to a qualified repair technician.

Proper Care of Your Scanner

- Use only the AC Adapter/Charger that came with your scanner.
- Avoid placing the scanner in direct sunlight or near heating elements or vents.
- Do not subject the scanner to extremes in temperature. If the scanner is exposed to temperatures below 14°F or above 140°F, the liquid crystal display may temporarily cease to function properly, or can become permanently damaged.

Optional Accessories and Replacement Parts

The following optional accessories and replacement parts for your **BC60XLT** are available from your local Uniden Dealer or through the Uniden Customer Service Center by calling: (800) 297-1023, 8:00 a.m. to 5:00 p.m. Central, Monday through Friday.

Ear Phone (64 Ω)
(EP009)

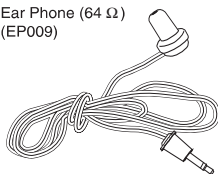

Cigarette Lighter Adapter
(PS001)

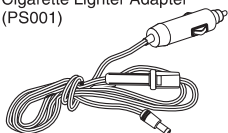

(For 12V negative ground systems only)

Rubber Antenna
(AT218)



AC Adapter/Charger
(AD100U)

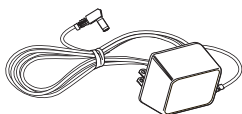

Belt Clip with
Screws
(BCK150)



BC60XLT
Operating Guide
(OMBC60XKT)

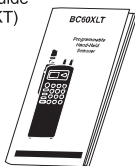

Betty Bearcat
Starter Frequency
Guide
(BBSTARTUP)

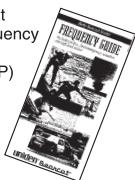

Operating Tips

If your **BC60XLT** is not performing properly, try the steps listed below.

CONDITION	SUGGESTION
Scanner doesn't turn on.	<p>Rotate the Volume control to the right.</p> <p>Check the Batteries for correct installation.</p> <p>Check the power level of the Batteries. Replace or recharge Batteries as necessary.</p> <p>Check the AC Adapter/Charger or the (optional) Cigarette Lighter Adapter for a good electrical contact at the scanner.</p> <p>Make sure there is power at the AC outlet (or the vehicle's cigarette lighter).</p> <p>Check the in-line fuse on the (optional) Cigarette Lighter Adapter cord. If blown, replace it with the same type of fuse.</p>
Poor reception.	<p>Check the antenna connection.</p> <p>Make sure the antenna is in a vertical position.</p> <p>If you're inside a building, move the scanner to a window, an outside wall, or outdoors.</p> <p>Check for sources of interference such as computers, microwave ovens, or other electrical devices. Move the scanner as necessary.</p> <p>You may be too far away from the stations using the frequencies you have programmed. Try another location, or program frequencies for stations closer to your area.</p>
Scanner doesn't receive weather channels.	<p>Adjust the Squelch setting. It may be too high.</p> <p>In some parts of the country, you may not be able to monitor weather broadcasts, such as in low lying areas. Move the scanner to a higher location.</p> <p>Reception may be poor. See above for suggestions.</p>

CONDITION	SUGGESTION
Scan doesn't stop.	<p>Adjust the Squelch setting. It may be too high.</p> <p>Check the antenna connection. Make sure the antenna is in a vertical position.</p> <p>Reception may be poor. See above for suggestions.</p> <p>It is possible that none of the programmed frequencies are active at the time.</p>
Scan doesn't start.	<p>Make sure there are some programmed channels.</p> <p>The scanner may be in Manual mode. Press SCAN to begin scanning.</p> <p>The scanner may be stopped on a weather frequency. Press SCAN to begin scanning.</p> <p>Adjust the Squelch setting. It may be too low.</p> <p>All the channels may be locked out. Turn off Lockout for the channels you want to scan.</p>
Keypad won't work.	<p>Check the Keylock. Make sure Keylock is off before programming or locking out channels.</p>

If you still cannot get satisfactory results and want additional information, or to return the unit for service, please call or write the Uniden Parts and Service Division. The address and phone number are listed in the Warranty (at the end of this manual).

Technical Specifications

Channels:	10
WX:	7 Programmed Channels (All NOAA Weather Service)
Frequency Coverage:	29.00 to 29.70 MHz 29.70 to 50.00 MHz 50.00 to 54.00 MHz 137.00 to 144.00 MHz 144.00 to 148.00 MHz 148.00 to 174.00 MHz 406.00 to 420.00 MHz 420.00 to 450.00 MHz 450.00 to 470.00 MHz 470.00 to 512.00 MHz
Scan Rate:	10 channels per sec. Max.
Scan Delay:	2 seconds
Audio Output:	250 mW nominal into 8 Ω internal speaker
Antenna:	Rubber antenna included
Operating Temperature:	- 10°C (14°F) to + 60°C (+ 140°F)
Size:	2-1/2" (W) x 1-3/4" (D) x 12-3/4" (H) (with antenna attached)
Weight:	12.6 oz
Power Requirements:	6.0V DC — provided by 4 AA Alkaline Batteries 4.8V DC — provided by 4 AA rechargeable Nickel-Cadmium Batteries, or External 12V DC — provided by the included AC Adapter/Charger, or an optional Cigarette Lighter Adapter

Certified in accordance with FCC Rules and Regulations Part 15 Subpart C as of date of manufacture.

Features, specifications, and availability of optional accessories are all subject to change without notice.

One Year Limited Warranty

WARRANTOR: UNIDEN AMERICA CORPORATION (“Uniden”)

ELEMENTS OF WARRANTY: Uniden warrants, for one year, to the original retail owner, this Uniden Product to be free from defects in materials and craftsmanship with only the limitations or exclusions set out below.

WARRANTY DURATION: This warranty to the original user shall terminate and be of no further effect 12 months after the date of original retail sale. The warranty is invalid if the Product is (A) damaged or not maintained as reasonable or necessary, (B) modified, altered, or used as part of any conversion kits, sub- assemblies, or any configurations not sold by Uniden, (C) improperly installed, (D) serviced or repaired by someone other than an authorized Uniden service center for a defect or malfunction covered by this warranty, (E) used in any conjunction with equipment or parts or as part of any system not manufactured by Uniden, or (F) installed or programmed by anyone other than as detailed by the Operating Guide for this product.

STATEMENT OF REMEDY: In the event that the product does not conform to this warranty at any time while this warranty is in effect, warrantor will repair the defect and return it to you without charge for parts, service, or any other cost (except shipping and handling) incurred by warrantor or its representatives in connection with the performance of this warranty. THE LIMITED WARRANTY SET FORTH ABOVE IS THE SOLE AND ENTIRE WARRANTY PERTAINING TO THE PRODUCT AND IS IN LIEU OF AND EXCLUDES ALL OTHER WARRANTIES OF ANY NATURE WHATSOEVER, WHETHER EXPRESS, IMPLIED OR ARISING BY OPERATION OF LAW, INCLUDING, BUT NOT LIMITED TO ANY IMPLIED WARRANTIES OF MERCHANT ABILITY OR FITNESS FOR A PARTICULAR PURPOSE. THIS WARRANTY DOES NOT COVER OR PROVIDE FOR THE REIMBURSEMENT OR PAYMENT OF INCIDENTAL OR CONSEQUENTIAL DAMAGES. Some states do not allow this exclusion or limitation of incidental or consequential damages so the above limitation or exclusion may not apply to you.

LEGAL REMEDIES: This warranty gives you specific legal rights, and you may also have other rights which vary from state to state. This warranty is void outside the United States of America.

PROCEDURE FOR OBTAINING PERFORMANCE OF WARRANTY: If, after following the instructions in this Operating Guide you are certain that the Product is defective, pack the Product carefully (preferably in its original packaging). Include evidence of original purchase and a note describing the defect that has caused you to return it. The Product should be shipped freight prepaid by traceable means, or delivered, to warrantor at:

Uniden America Corporation
Parts and Service Division
4700 Amon Carter Blvd.
Ft. Worth, TX 76155

(800) 297-1023, 8 a.m. to 5 p.m. Central, Monday through Friday

Download from www.Somanuals.com. All Manuals Search And Download.

COVERED UNDER ONE OR MORE OF THE
FOLLOWING U.S. PATENTS

RE 31,523	4,027,251	4,057,760	4,092,594	4,100,497
4,114,103	4,123,715	4,156,193	4,157,505	4,179,662
4,219,821	4,270,217	4,398,304	4,409,688	4,455,679
4,461,036	4,521,915	4,627,100	4,888,815	4,932,074
4,947,456	5,014,348	5,199,109		

uniden®

Beancat®

Free Manuals Download Website

<http://myh66.com>

<http://usermanuals.us>

<http://www.somanuals.com>

<http://www.4manuals.cc>

<http://www.manual-lib.com>

<http://www.404manual.com>

<http://www.luxmanual.com>

<http://aubethermostatmanual.com>

Golf course search by state

<http://golfingnear.com>

Email search by domain

<http://emailbydomain.com>

Auto manuals search

<http://auto.somanuals.com>

TV manuals search

<http://tv.somanuals.com>