

# UH-042XR

## Operating Guide



# Uniden

## WARNING!

- Do not operate the transmitter of any radio equipment unless all the Radio Frequency (RF) connectors are secured and any open connectors are properly terminated.
- Do not operate the transmitter of any radio equipment near electrical blasting caps or in an explosive atmosphere.
- Do not let children operate any transmitter-equipped radio equipment unless supervised.
- Have your radio equipment serviced by a qualified Uniden technician.
- Do not operate the transmitter of any radio equipment with the antenna touching or close to the eyes, face, or exposed body parts.



*The exclamation point within an equilateral triangle is intended to alert the user to the presence of important operating and maintenance (servicing) instructions in the literature accompanying the appliance.*

# CONTENTS

## Introduction

Features	1
Technical Support & Service	2
Included in your UH-042XR Package	3

## Getting Started

Battery Installation	4
Low Battery Alert	5
Belt Clip	5

## Operation

Power on/off	6
Volume	6
Selecting a Channel	7
To Transmit and Receive	7
To Operate in Duplex Mode	8
Scanning	8
Open Scan	8
Group Scan	9
Priority Channel	10
Programming Scan Channels	10
Continuous Tone Coded Squelch System (CTCSS)	11
Built-in Voice Activated Circuit (VOX)	13
Drop-Out Delay	14
Power Save	14
Busy Channel Lock-out	15
Sending Call Tones	15
Backlight	16
Keypad Lock	16
Monitor	16
Battery Level Display	17
Charging Batteries	18

<b>UHF Channels and Frequencies</b>	19
-------------------------------------	----

<b>CTCSS Codes and Frequencies</b>	20
------------------------------------	----

<b>Optional Accessories</b>	20
-----------------------------	----

<b>Technical Specifications</b>	20
---------------------------------	----

<b>Warranty</b>	22
-----------------	----

<b>Controls &amp; Indicators</b>	24
----------------------------------	----

# INTRODUCTION

The **UH-042XR** is a portable two-way UHF-CB radio. It is compact, rugged and fits easily in your hand. This hand held UHF radio will give you consistent, outstanding performance in virtually all conditions and situations. To ensure that you get the most from the **UH-042XR**'s features, please read this operating guide carefully before using the unit.

## FEATURES

- 40 Channels
- 500mW Output Power
- Up to 3 km range\*
- LCD Display
- Group Scan
- Open Scan
- Duplex Capability
- 38 Built-in Continuous Tone Coded Squelch System (CTCSS)
- Monitor
- Busy Channel Lock-out
- LCD Back Light (Auto On for 5 Sec)
- Built-in Voice Activated Function (VOX)
- Auto Power Save
- Battery Level Indicator
- Built in Keypad Lock
- 2 Different Ring Tones
- Auto Squelch Control

*\* Range varies depending on the environment. 3km range is noted in a flat open environment.*

## TECHNICAL SUPPORT AND SERVICE

Should you find it desirable or necessary to service your **UH-042XR**, we suggest you contact the Uniden dealer where you purchased your radio. Your dealer will be able to assist you with the complete service information.

If you require service that is within the terms of your warranty, you should present a copy of your receipt to your dealer to authenticate your claim.

If you find it inconvenient to obtain service assistance from a dealer, please pack your radio in suitable packaging that will provide adequate protection to your radio. Enclose a note describing the problem, a copy of your receipt, and send it prepaid to:

### AUSTRALIA:

Uniden Australia Pty Ltd  
Customer Service Division  
345 Princes Highway  
Rockdale NSW 2216  
Ph. (02) 9599-3355  
Fax. (02) 9599-3278  
Toll Free 1300 366 895

### NEW ZEALAND:

Uniden New Zealand Ltd  
Customer Service Division  
150 Harris Road  
East Tamaki, Auckland  
Ph. (9) 273 8383  
Fax. (9) 274 4253  
Toll Free 0800 4 UNIDEN  
4 864336

**Caution:** *Changes or modifications to this product not expressly approved by Uniden; or operation of this product in any way other than as detailed by this Operating Guide, can void your warranty and authority to operate this product.*

## INCLUDED IN YOUR UH-042XR PACKAGE



Wrist Strap



Belt Clip



Operating Guide

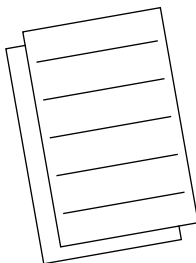

Product Registration Card  
and other printed materials

*Note: If any of these items are missing from the box, contact your Uniden Dealer.*

# GETTING STARTED

## BATTERY INSTALLATION

Your UH042XR radio uses 3 AA ALKALINE batteries for power.  
Please refer to page 18 should you wish to use rechargeable batteries.

To install the batteries:



*Do not mix old and new batteries to avoid damage to the unit.*

1. Make sure your radio is off.
2. Release the battery cover clip, then remove the battery cover.

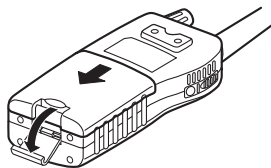

3. Insert 3 AA ALKALINE batteries according to the polarity symbols inside the battery compartment.

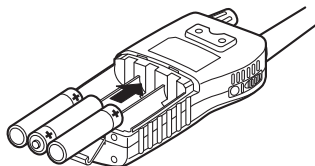

4. Align the battery cover tabs with the UH042XR tab holes then replace the cover.

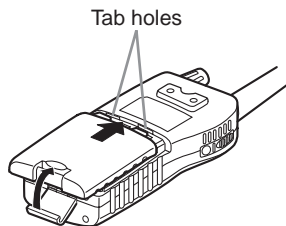

*Note: Batteries are not supplied*

## LOW BATTERY ALERT

The LCD on your radio shows a battery meter in the lower right corner.

■■■■■ icon indicates a fully powered unit. As the batteries lose power,

⚡ will flash.

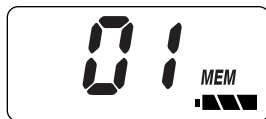

When the batteries in the unit are low, the unit will go into a Battery Low/Sleep Mode. The Scan Mode, Transmit, Transmit Call Tone Mode are disabled. Replace the batteries immediately to continue using the radio.

## BELT CLIP

As you will usually use your radio when you are out and about, the unit comes equipped with a belt clip to securely fasten the unit to your belt, pocket or purse.

To remove the belt clip, turn the screw counterclockwise.

To attach the belt clip:

1. Insert the belt clip screw into the slot on the belt clip.
2. Align the screw with the hole on the back of the radio and turn it clockwise, using a Phillips screwdriver to secure the belt clip. Do not over-tighten.

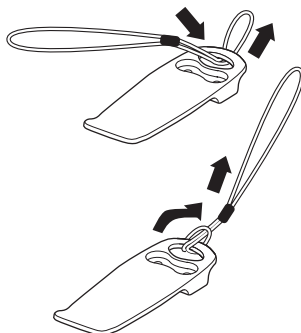
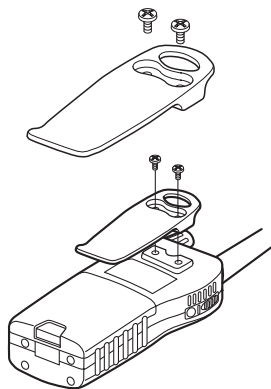

## WRIST STRAP

1. Insert the short end of the strap through the belt clip hole.
2. Slip the long end through the loop to enclose the clip in the strap and pull tightly.



## OPERATION

- When you press any key (except PTT), a short tone sounds.
- See the Controls and Indicators page at the back of this operating guide for button and key operations.

### POWER ON/OFF

To turn the unit **ON**, rotate the [ON/OFF VOL] clockwise until a “click” is heard. A channel number and battery level should appear on the display.



To turn the unit **OFF**, rotate the [ON/OFF VOL] knob counter-clockwise until a “click” is heard. The display will disappear.



### VOLUME

1. Press the [MON] button to hear background noise. The “BUSY” icon (📶) will appear on the display.
2. Turn the [ON/OFF VOL] control clockwise to increase the volume, counterclockwise to decrease the volume.

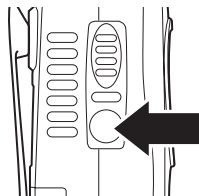

## SELECTING A CHANNEL

Press [▲] or [▼] to select the desired channel.

*Note: If you press and hold the [▲] or [▼], channel numbers will scroll rapidly.*

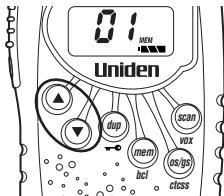

## TO TRANSMIT AND RECEIVE

The **UH-042XR** uses the 40 UHF-CB Channels. For your reference a list of the available channels and corresponding frequencies is printed at the end of this manual.

1. The maximum RF transmit power of **UH-042XR** is 500 mWatts.
2. Before you transmit, listen for activity on the selected channel.
3. When the channel is clear, press and hold the [PTT] to transmit.  
 appears on the LCD.

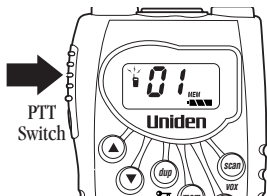

*Hold the radio with microphone approximately two inches in front of your mouth with the antenna at approximately 45° angle away from your head. Speak in a clear, normal conversational voice.*

4. When you have finished speaking, release the [PTT] and listen for a response. TX icon then disappears from the LCD.

The display shows  when a transmission is being received by your radio.

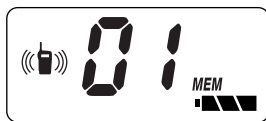

## TO OPERATE IN DUPLEX MODE

Eg. CH01 is being used in your area for repeater purpose.

Press **[DUP]** momentarily. The **DUP** icon appears.

Press **[DUP]** again to deactivate the duplex operation. **UH-042XR** will return to simplex operation.

**DUP** icon disappears.

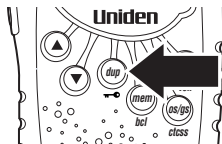

## SCANNING

The **UH-042XR** has two types of scanning; Open Scanning (OS) and Group Scanning (GS), giving you flexibility and allowing you to use the radio more effectively.

Scanning allows you to search for active channels programmed in the OS or GS memory.

To initiate scanning,

1. Assuming the unit is on CH01 when switched on.
2. Press **[SCAN]** and scanning starts. Scan icon flashes during scanning.

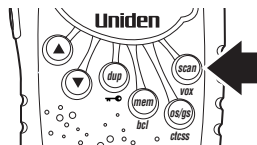

### 1. Open Scan (OS) Mode

(the absence of GS icon indicates that the unit is on OS mode)

Allows continuous scanning of channels stored in the Open Scan (OS) memory. If an active channel is found, scanning will stop on that channel.

*Note: The factory has preprogrammed all the 40 UHF channels into the Open Scan channel memory. However, you can change or customise the channels by following the steps on programming Scan Channels on pages 10.*

### **Example: CH40 becomes active**

If the received signal ceases, the unit will wait for at least 3 seconds for the signal to return, otherwise scanning resumes.



To skip the active channel, press **[MEM]** momentarily. Scanning resumes.

To deactivate SCAN, press the **[SCAN]** or **[PTT]**.

*Note:*

1. If **SCAN** is deactivated while in an active channel, the UH-042XR will stay on that active channel. If no other channels are active, the UH-042XR will reinstate the starting channel.
2. Pressing **[OS/GS]** will switch to Group Scanning.

## **2. Group Scan (GS) Mode**

To use GS Mode Scanning, press the **[OS/GS]** key. **GS** icon appears on the display.

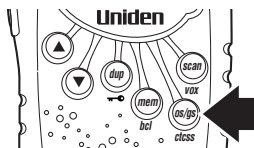

1. When **[SCAN]** is pressed during Group Scan Mode, **SCAN** icon will flash and Group Scan Scanning begins.



2. To deactivate GS scan, press **[SCAN]** or **[PTT]**.

*Note:*

1. If **SCAN** is deactivated while it is tuned to an active channel, the UH-042XR will stay on that active channel. If none of the channels are active, the UH-042XR will reinstate the Priority channel.
2. If GS Scanning is initiated when there are no channels programmed in GS memory, an error tone will be heard and scanning will not start.
3. Pressing **[OS/GS]** will switch to Open Scanning.



## PRIORITY CHANNEL

The *Priority Channel* feature allows user to monitor one of 40 channels in the **UH-042XR**, monitoring it every 1.5secs during *Group Scanning*.

### Choosing a *Priority Channel*

The starting channel, when *Group Scanning* is initiated, is always the *Priority Channel*. To change the priority channel setting while scanning, (eg. PRI Channel is CH17 (476.825 MHz))

- a. press [▲], to select a higher channel  
(scanning pauses)
- or
- b. press [▼], to select a lower channel



## Programming Scan Channels

1. Select which Scanning Mode you wish to use on the channel  
OS or GS Mode

*Note: OS is indicated by the absence of the GS icon*

2. Select the channel you want to store by pressing [▲] or [▼]
3. Pressing [MEM] momentarily to store. **MEM** icon appears and beep sounds are heard.
4. To remove the channel from Memory, press [MEM] momentarily. **MEM** icon disappears and beep sounds are heard.

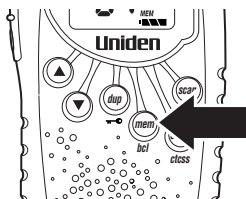
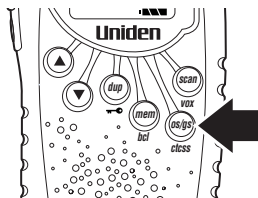

## CONTINUOUS TONE CODED SQUELCH SYSTEM (CTCSS)

CTCSS is a feature that allows a group to talk to each other without hearing other users on the same channel.

*NOTE : Uniden discourages the use of CTCSS feature until the Australian Communications Authority (ACA) grants the use of CTCSS on CB frequencies.*

### Programming CTCSS Code

1. Select a desired channel to be used with **CTCSS**.
2. Press and hold [**CTCSS**] for 1.5 secs. CTCSS code indicator blinks.
3. Press [**▲**] or [**▼**] to select the desired CTCSS code.
4. Press [**CTCSS**] to save the selected code.  
**CTCSS** icon stops blinking.



*NOTE: There are 38 available CTCSS tone per channel. Channel 5 and 11 should not be programmed CTCSS. These channels shall be used for emergency purposes only and must be 'OPEN' at all times.*

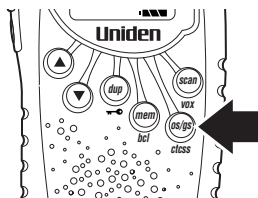

## CTCSS Scan Operation

1. Press **[SCAN]** to start scanning (GS or OS) mode.
2. During scanning if a signal is sensed on a CTCSS CH, the **UH-042XR** stops for about 400msecs (decode time) to decode the CTCSS code. If there is no code or the receive code does not match the one programmed on the unit, the unit resumes scanning.

On the example below only radio 1 and 9 can communicate or hear each other because they are using the same or common CTCSS code.

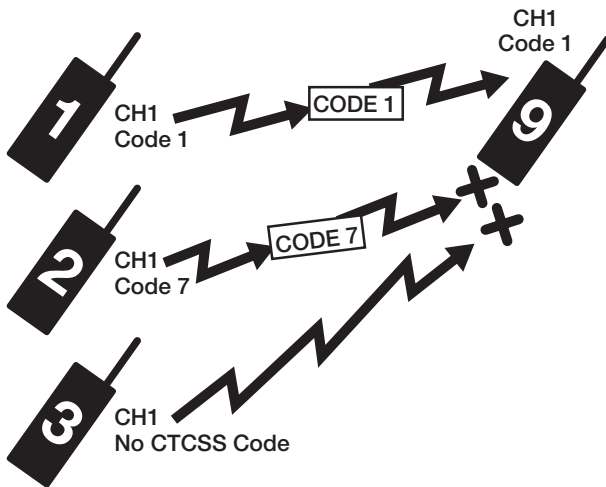

## BUILT-IN VOICE ACTIVATED CIRCUIT (VOX)

VOX feature enables user to transmit automatically by speaking on the microphone of the VOX headset (not supplied) without pressing the PTT switch.

*NOTE: VOX feature will not work without the Headset Microphone.*

*Built in [PTT] of UH-042XR is temporarily disabled, however accidental pressing of [PTT] will cause the unit to transmit briefly.*

### To activate VOX

1. Turn the UH-042XR OFF.
2. Press and hold **[VOX]** while turning the radio ON. “**VOX**” appears on the bottom left of the display.
3. To set sensitivity. Press and hold **[VOX]**, “**VOX**” icon starts blinking.
4. Press either **[▲]** or **[▼]** within 10 secs. to select the desired VOX level number (9 with the lowest sensitivity to 1 with the highest sensitivity).
5. Press **[VOX]** to save the selected level. “**VOX**” icon stops blinking.
6. Install VOX Headset (not supplied) to **UH-042XR**

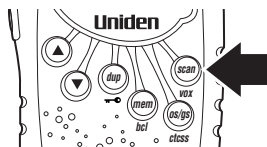

### Installing VOX Headset

1. Remove SPEAKER MIC COVER.
2. Attach VOX headset mic by pushing jack down through to the speaker mic port of **UH-042XR** until it sits firmly on the radio.

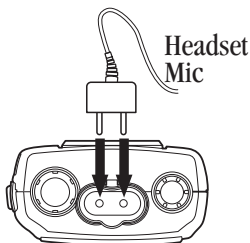
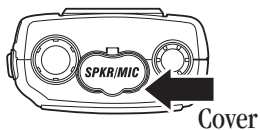



## To De-activate VOX

1. Turn OFF **UH-042XR**.
2. Remove VOX Headset from **UH-042XR**.
3. Press and hold **[VOX]** while turning the radio ON. “VOX” icon disappears.
4. **UH-042XR** returns to PTT operation.



*Note: Turning ON the radio without removing the VOX headset will cause the unit to transmit continuously.*

## DROP-OUT DELAY

While scanning, the **UH-042XR** stops at a busy channel and receives a transmission. When the received signal is over, the unit will wait for 3 seconds for the return of the signal, otherwise, the radio resumes scanning.

## POWER SAVE

Battery Save feature extends the battery life by switching the receiver circuit power ON and OFF. This feature automatically activates during stand by mode (RX mode without signal). It turns OFF automatically when a signal is present, and activates again after channel inactivity.

## BUSY CHANNEL LOCK-OUT(BCL)

This feature prevents accidental transmission on a busy channel.

This is recommended on channels where CTCSS is being used. If the channel is “active” and the signal is coming from a non or different CTCSS code user the BCL feature will prevent you from transmitting.

### To activate BCL

Press and hold [BCL] for 1.5 secs until “BCL” appears on display.

### To De-activate BCL

Press and hold [BCL] for 1.5 secs. until “BCL” disappears from the display.

## SENDING CALL TONES

The *UH-042XR* is equipped with two types of tones that user can use to alert other users or identify yourself prior to transmission. You can also apply the signal at the end of the transmission.

### To use the Call Tones,

Press [▲] (for call tone A) or [▼] (for call tone B) while pressing the [PTT] switch. Call tone will be transmitted for 3 seconds. (You will also hear this tone from your radio as well).

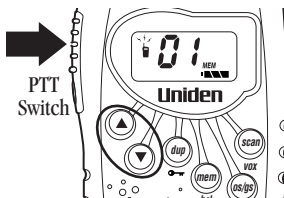
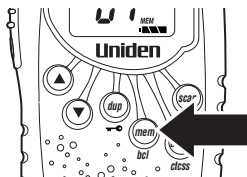

## BACK LIGHT

The Liquid Crystal Display (LCD) is backlit for easy viewing at night or in low light situations. The back lighting automatically switches ON every time a key (except PTT) is pressed. It turns OFF 5secs after the last key is pressed.

## KEYPAD LOCK

To prevent accidental entries, you can lock the keypad.

Press and hold the **[LOCK]** button for 1.5 secs. until it beeps to activate Key Lock.

🔑 icon appears.

To unlock the keypad, press and hold the **[LOCK]** button again for 1.5 secs. 🔑 icon disappears.

Note: When the Key Lock is active, a warning beep will be heard if you attempt to press the keys.



## MONITOR

This feature enables users to listen in for weak signals on the current channel at the press of a button.



### To use monitor,

- For brief listening, press **[MON]**
- For continuous listening. Press and hold **[MON]** for 2 secs. A two tone beep will be heard and the receiver circuit will stay open, letting in both the noise & weak signals.
- Display shows ((📶)) icons.
- To return to normal receive mode press **[MON]**, **[SCAN]**, **[PTT]** **[▲]** or **[▼]**.

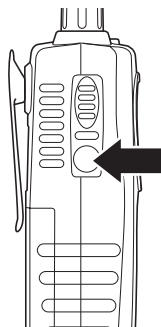

## BATTERY LEVEL DISPLAY

The  icon in the bottom right hand corner of the screen indicates the **UH-042XR** current battery voltage level at all times. The battery level is displayed in 3 levels:

**LEVEL 3**  
Battery 100% full

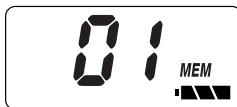

**LEVEL 2**  
Battery approx  
70% capacity

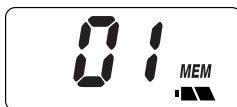

**LEVEL 1**  
Battery approx  
30% capacity



**Almost Empty**



**Note:**  
When [PTT] SW is pressed at  
Level Empty, battery icon and  
channel number will flash



## CHARGING BATTERIES

**Warning Notice!** Use only the AAD042S optional power adaptor if rechargeable batteries will be used in the UH042XR.

- Turn the UH042XR **[ON/OFF VOL]** knob off and connect the AC adaptor plug to the mic jack.
- Battery charging times vary. A longer time is required to charge higher capacity batteries.

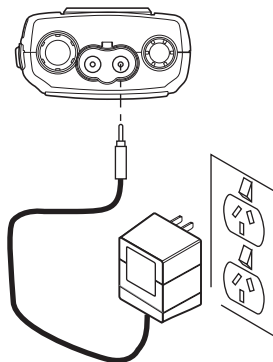

Rechargeable Batteries	Charging Time
600mAH Ni-Cad	14-16 hrs
1000mAH Ni-Cad	24-27 hrs
1300mAH Ni-MH	31-35 hrs

- Disconnect the AC adaptor from the unit when charging is completed.

## UHF CHANNELS & FREQUENCIES

Ch.	Freq.	Usage	Ch.	Freq.	Usage
01	476.425	Simplex/Duplex	21	476.925	Simplex
02	476.450	Simplex/Duplex	22	476.950	Simplex
03	476.475	Simplex/Duplex	23	476.975	Simplex
04	476.500	Simplex/Duplex	24	477.000	Simplex
05	*476.525	Simplex/Duplex	25	477.025	Simplex
06	476.550	Simplex/Duplex	26	477.050	Simplex
07	476.575	Simplex/Duplex	27	477.075	Simplex
08	476.600	Simplex/Duplex	28	477.100	Simplex
09	476.625	Repeater	29	477.125	Simplex
10	476.650	Repeater	30	477.150	Simplex
11	#476.675	Back-up Emergency Channel	31	477.175	Simplex
12	476.700	Repeater	32	477.200	Simplex
13	476.725	Repeater	33	477.225	Simplex
14	476.750	Repeater	34	477.250	Simplex
15	476.775	Repeater	35	477.275	Simplex
16	476.800	Repeater	36	477.300	Simplex
17	476.825	Repeater	37	477.325	Simplex
18	476.850	Repeater	38	477.350	Simplex
19	476.875	Repeater	39	477.375	Simplex
20	476.900	Repeater	40	477.400	Simplex

\* Emergency calling for both simplex and duplex operation  
*Please do not use this channel in non-emergency cases.*

# Back-up Emergency Channel

## CTCSS CODES & FREQUENCIES

Code No.	Freq. (Hz)	Code No.	Freq. (Hz)	Code No.	Freq. (Hz)
00('oF')	OFF	13	103.5	26	162.2
01	67.0	14	107.2	27	167.9
02	71.9	15	110.9	28	173.8
03	74.4	16	114.8	29	179.9
04	77.0	17	118.8	30	186.2
05	79.7	18	123.0	31	192.8
06	82.5	19	127.3	32	203.5
07	85.4	20	131.8	33	210.7
08	88.5	21	136.5	34	218.1
09	91.5	22	141.3	35	225.7
10	94.8	23	146.2	36	233.6
11	97.4	24	151.4	37	241.8
12	100.0	25	156.7	38	250.3

## OPTIONAL ACCESSORIES

- Speaker Microphone (SM-050)
- AC Adaptor (AAD-042S)
- VOX Headset (VM-052)
- Standard Headset (HM-050)

## TECHNICAL SPECIFICATIONS

### General

Channels	Transmit 40 (with Duplex Channel Support) Receive 40
Oper. Temp.	0°C - +55°C
Antenna	Fixed
Microphone	Built-in Electret type

Display	Liquid Crystal Display
Speaker	36mm Round, 8Ω
Power Source	AA Size Battery x 3pcs
Size	(with antenna) 180(H) x 62(W) x 32(D)mm
Weight	150g (with Antenna & without Battery)
Operating Time at	17 hrs (1.2V, 600mAH Ni-Cd Batteries)
Duty Cycle	25 hrs (1.2V, 1000mAH Ni-Cd Batteries)
5 Secs. Tx, 5 Secs. Rx,	32 hrs (1.25V, 1300mAH Ni-MH Batteries)
90 Secs. Standby	38 hrs (1.5V, 1500mAH Alkaline Batteries)

### **Transmitter**

Frequency Control	Phase Locked Loop
Frequency Range	476.425 to 477.4 MHz
Frequency Stability	±3 ppm
Power Output	0.5W
Spurious Emissions	-40 dBm
Current Drain	320mA

### **Receiver**

Receiver Type	Dual Conversion Super Heterodyne Phase Locked Loop System for Local Oscillator
Frequency Range	476.425 to 477.4 MHz
Sensitivity @ 12 dB SINAD	0.22 μV
Squelch Sensitivity	0.19 μV (Threshold)
Audio Frequency Response	500Hz, 5dB (ref: 1KHz, ± 3KHz Dev.) 2000Hz, -6dB
Selectivity	50dB
Hum & Noise Ratio	37dB
Audio Output Drain	0.15W (10% THD)
Current Drain	150 mA 50mW output

*Specifications shown are typical and subject to change without notice.*



# WARRANTY

## UNIDEN UH-042XR UHF CB RADIO

### Limited One Year Warranty

*Note: Please keep your sales docket as it provides evidence of warranty.*

**Warrantor:** Uniden Australia Pty Limited ACN 001 865 498  
Uniden New Zealand Limited

**Elements of Warranty:** Uniden warrants to the original retail owner for the duration of this warranty, its UH-042XR UHF CB Transceiver Radio (hereinafter referred to as the Product) to be free from defects in materials and craftsmanship with only the limitations or exclusions set out below.

**Warranty Duration:** This warranty to the original retail owner only, shall terminate and be of no further effect ONE (1) Year after the date of original retail sale. This warranty will be deemed invalid if the product is; (A) Damaged or not maintained as reasonable and necessary, (B) Modified, altered or used as part of any conversion kits, subassemblies, or any configurations not sold by Uniden, (C) Improperly installed, (D) Repaired by someone other than an authorised Uniden Repair Agent for a defect or malfunction covered by this warranty, (E) Used in conjunction with any equipment or parts or as part of a system not manufactured by Uniden, (F) Installed, programmed or serviced by anyone other than an authorised Uniden Repair Agent, or (G) Where the Serial Number label of the product has been removed or damaged beyond recognition.

**Parts Covered:** This warranty covers for 1 year, the UHF CB Transceiver Unit only. Accessories: Belt Clip and Wrist Strap are covered for 90 days.

**Statement of Remedy:** In the event that the product does not conform to this warranty at any time while this warranty is in effect, the warrantor at its discretion, will repair the defect or replace the product and return it to you without charge for parts and service. This warranty does not cover provide for the reimbursement or payment of incidental or consequential damages.

**Warranty card:** If a warranty card has been included with this product, please fill it in and return it to us within 14 days of purchase. Your name and serial number of the product will then be registered in our database and this will help us process your claim with greater speed and efficiency should you require warranty service.

**Procedure for obtaining performance or warranty:** In the event that the Product does not conform to this warranty, the Product should be shipped or delivered, freight prepaid, with evidence of original purchase, (eg. a copy of the sales docket), to the warrantor at:

UNIDEN AUSTRALIA PTY LIMITED

Service Division

345 Princes Highway, Rockdale, NSW 2216

Ph (02) 9599 3577 Fax (02) 9599 3278 Toll Free 1300 366 895

UNIDEN NEW ZEALAND LTD

Service Division

150 Harris Road, East Tamaki, Auckland

Ph (9) 273 8383 Fax (9) 274 4253 Toll Free 0800 4UNIDEN  
4864336

Customers in other states should ship or deliver the Product freight pre-paid to the nearest Uniden Authorised Repair Centre. (Contact Uniden for the Warranty Agent nearest you.)

# CONTROLS & INDICATORS

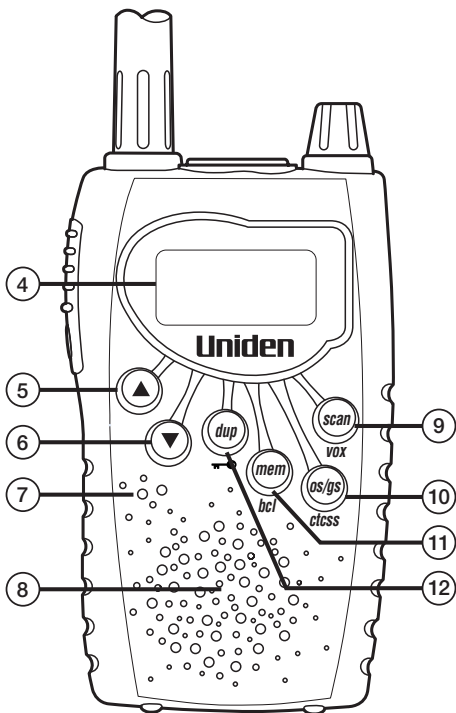
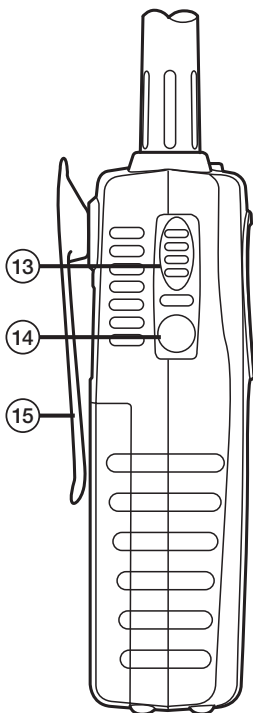
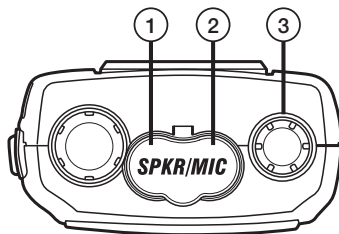

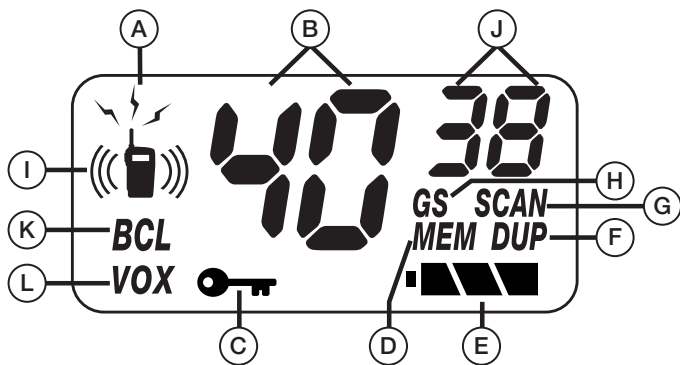

- |                            |                              |
|----------------------------|------------------------------|
| A. Transmit                | G. Scanning                  |
| B. Channel Numbers         | H. Group Scanning            |
| C. Key Lock                | I. Receiving                 |
| D. Memory                  | J. CTCSS Tone and VOX Levels |
| E. Battery Level Indicator | K. Busy Channel Lock         |
| F. Duplex Transmit         | L. VOX                       |

- |                        |                                       |
|------------------------|---------------------------------------|
| 1. Speaker Jack        | 10. Open/Group Scan and CTCSS Button  |
| 2. Microphone Jack     | 11. Memory/BCL Button                 |
| 3. On/Off Volume       | 12. Duplex and Key Lock On/Off Button |
| 4. LCD Display         | 13. PTT (Push-to-talk) Button         |
| 5. Up Button           | 14. Monitor Switch                    |
| 6. Down Button         | 15. Belt Clip                         |
| 7. Microphone          |                                       |
| 8. Speaker             |                                       |
| 9. Scan and VOX Button |                                       |

# Uniden

© 2000 Uniden Australia Pty Limited/Uniden New Zealand Limited  
UTZZ01877ZZ

## Free Manuals Download Website

<http://myh66.com>

<http://usermanuals.us>

<http://www.somanuals.com>

<http://www.4manuals.cc>

<http://www.manual-lib.com>

<http://www.404manual.com>

<http://www.luxmanual.com>

<http://aubethermostatmanual.com>

Golf course search by state

<http://golfingnear.com>

Email search by domain

<http://emailbydomain.com>

Auto manuals search

<http://auto.somanuals.com>

TV manuals search

<http://tv.somanuals.com>