

uniden®

UHF CB TRANSCEIVER

OWNER'S MANUAL

SUNDOWNER UH-088 SCANNING

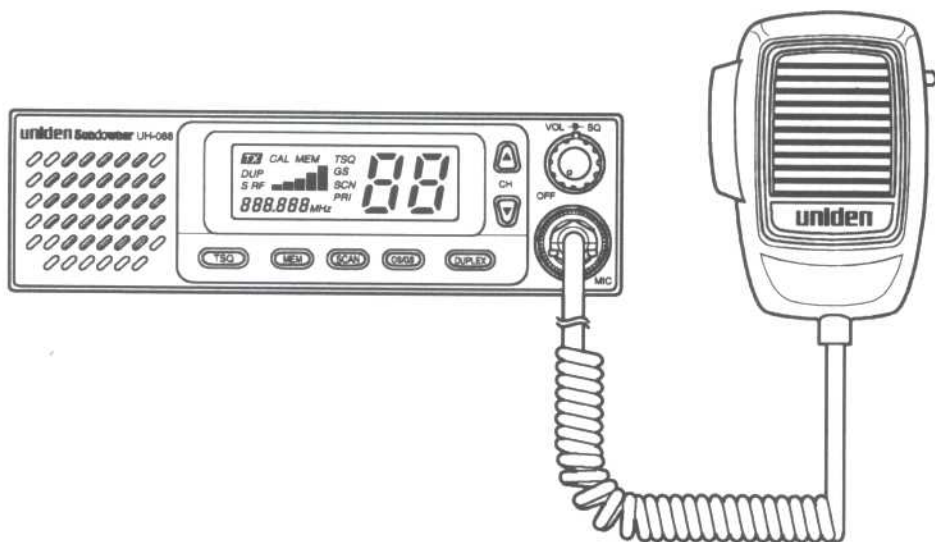

Table of Contents

Controls / Indicators / Connectors	3
Controls	3
Indicators	4
Connectors	5
Introduction	6
Included with your UH-088	7
Operation	8
Setting the Squelch	8
Selecting a Channel	9
Channel Auto Step	9
Transmitting	10
Using Repeater Channels	10
Scanning	13
Choosing a Priority Channel	15
Drop-Out Delay	15
Programming Scan Channels	16
Channel Seeking Operation	17
Selective Calling	18
Tone Squelch (Receiver Quieting)	19
Activating the Tone Squelch (Receiver Quieting)	20
Receiving Calls when in Quiet Mode	20
Tone Squelch Scanning	21
SELCALL Programming	22
Service	23
Care and Maintenance	24
Notice	24
Preventive Maintenance	24
Troubleshooting	24
Memory Backup	24

UHF CB Channel Information	25
SIMPLEX Operating Mode	25
DUPLEX Operating Mode	26
Specifications	27
General	27
Measurement Conditions	28
Transmitter Section	28
Receiver Section	28
SELCALL	29
Warranty	30

Controls / Indicators / Connectors

Controls

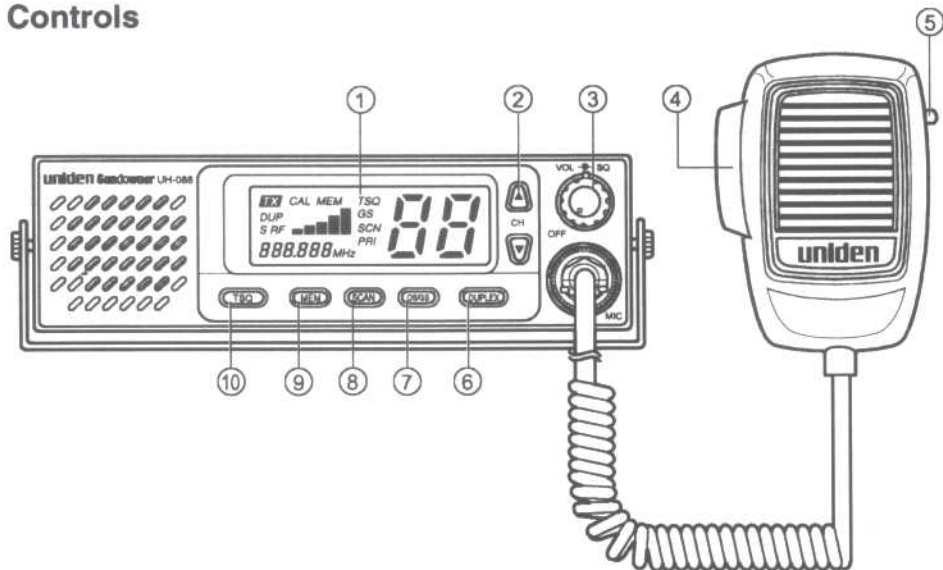

1. **LIQUID CRYSTAL DISPLAY (LCD) PANEL** - Indicators for TX, CAL, MEM, TSQ, GS (OS), SCN, PRI, Channel Number, Frequency, Signal Strength Level (S), Transmit Power Level (RF) and DUP.
2. **UP/DOWN CHANNEL SELECTOR** - These controls are used to select the desired communication channel.
3. **ON/OFF, VOLUME & SQUELCH CONTROLS**
ON/OFF & Volume Control (Centre Knob)
Turns the UH-088 power ON or OFF and adjusts the volume.
Squelch Control (Outer Ring)
Eliminates background noise in the absence of an incoming signal.
4. **PUSH-TO-TALK (PTT) SWITCH** - Press to transmit and release to receive.
5. **TONE CALL CONTROL BUTTON** - Press to transmit SELCALL codes, it functions on condition that SELCALL option is installed.
6. **DUPLEX Control**
Press this button momentarily to choose semi-duplex operation for Channels 1 through 8.
7. **OPEN SCAN/GROUP SCAN CONTROL (OS/GS)** - Switches operation between OPEN SCAN and GROUP SCAN Mode.
8. **SCAN CONTROL (SCAN)** - Press to activate Normal OS/GS scanning or press and hold to enable Seek Mode OS/GS Scanning.

9. **MEMORY CONTROL (MEM)** - Places channel numbers into the memory scan list (OS or GS).
10. **TONE SQUELCH CONTROL (TSQ)** - Controls Tone Squelched operation (quiet Mode) on condition that SELCALL option is installed.

Indicators

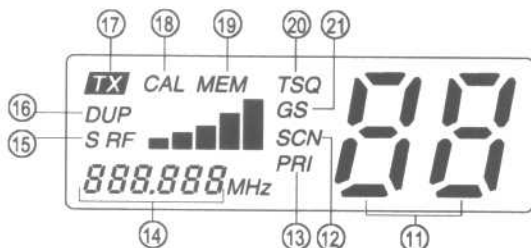

11. **Channel Indicator** - Indicates the channel number currently selected. On TX SELCALL usage the Channel Indicator becomes a Memory location indicator.
12. **Scan Indicator (SCN)** - SCN icon appears when Normal Scan mode is activated. When Seek Mode Scanning is selected the SCN icon blinks.
13. **Priority Indicator (PRI)** - Indicates that Priority channel is active when continuously lit or Flashes when it is regularly being checked for activity while GS scanning.
14. **Frequency Indicator** - Shows the frequency of the current selected channel.
15. **RECEIVE SIGNAL / RF LEVEL Indicator (S / RF)** - Indicates the relative signal strength level when receiving (S) or the relative transmit power (RF) when transmitting.
16. **DUPLEX Indicator (DUP)** - The DUP icon appears when duplex operation is selected.
17. **TRANSMIT Indicator (TX)** - TX appears when the PTT button on the microphone is pressed and the radio is transmitting. The RF icon also appears at this time.
18. **CALL Indicator (CAL)** - The CAL icon appears when the UH-088 radio is called using SELCALL. It also appears when SELCALL codes are being transmitted.
19. **MEMORY Indicator (MEM)** - MEM appears when the displayed channel is programmed either in GS or OS Memory.
20. **TONE SQUELCH Indicator (TSQ)** - The TSQ icon will appear when the selected channel is set to operate in Quiet Mode, or flashes when the radio is called using SELCALL.
21. **GROUP SCAN Indicator (GS)** - The GS icon appears when Group Scan Mode is activated. Open Scan is indicated by the absence of the GS icon.

Connectors

Front Panel

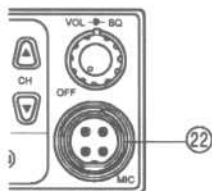

22. MICROPHONE SOCKET

The microphone plug is inserted into this socket.

Back Panel

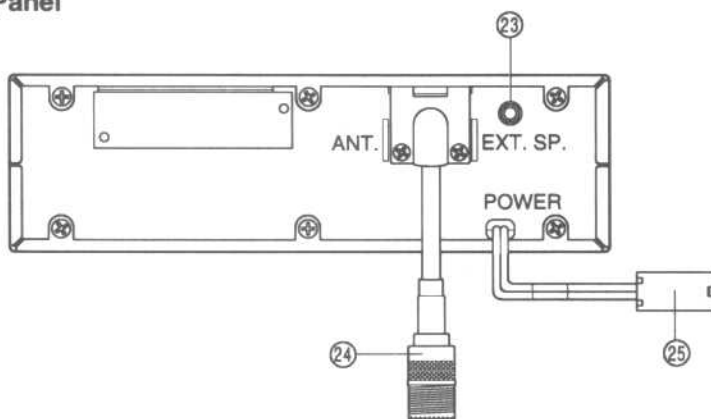

23. EXTERNAL SPEAKER JACK - Used for remote receiver monitoring. When the external speaker is connected, the internal speaker is automatically disconnected. The connecting wire must use a 3.5mm miniature plug only.

24. ANTENNA CONNECTOR - Connect the Antenna here using a PL259 type connector.

25. DC POWER CORD - DC power is connected to the transceiver through this jack. A power cord is supplied with the transceiver.

Introduction

The Uniden UH-088 UHF two way radio is designed to provide you with years of trouble free service. Its rugged components and materials are capable of withstanding harsh environments. The unit may be mounted in several convenient locations using the universal mounting bracket.

You can be confident in your choice of radio equipment because the UH-088 offers, Wide Liquid Crystal Display, Back-lit Control buttons, complete coverage of the UHF CB Frequency Band, and much more.

We are certain that you will enjoy your UH-088. Please read this operating guide carefully to ensure you gain the optimum performance of the unit.

General Features

- Full Coverage of the UHF CB Band
- 5 Watt Max. Transmitter
- External Speaker Jack
- Full Frequency Display
- Wide Liquid Crystal Display
- Back-lit Control Buttons
- Duplex Capability
- Open Scanning
- Group Scanning / Priority Channel Monitoring
- Channel Seek Mode
- Push Button Channel Control
- Front Fire Speaker
- SELCALL (Optional)

Specifications, features, and availability of optional Accessories are all subject to change without prior notice.

Included with your UH-088



UH-088 Owner's Manual

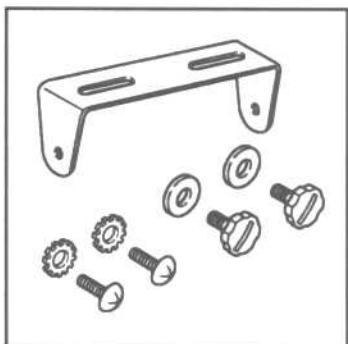

Mounting Bracket, Knobs,
Rubber Washer, Washer Stars
and Screws



Warranty Registration Sheet

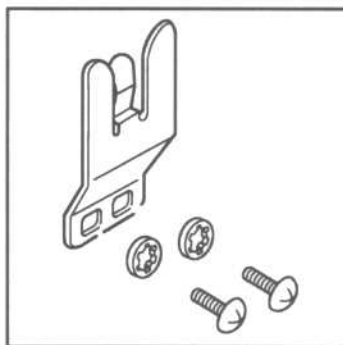

Microphone Hanger, Screws
and Washers

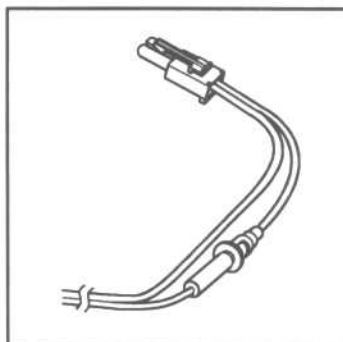

DC Power Cord with Fuse

Operation

Setting the Squelch

1. To turn the unit **ON**, rotate **VOLUME** clockwise.
Adjust volume to a comfortable level.

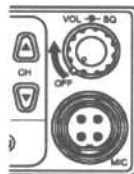

Note: You must select a channel which is not in use before setting the SQUELCH control on your radio.

2. Think of the Squelch control as a gate. If you turn SQUELCH fully clockwise it raises the "Squelch Gate" so high that no signals get through.

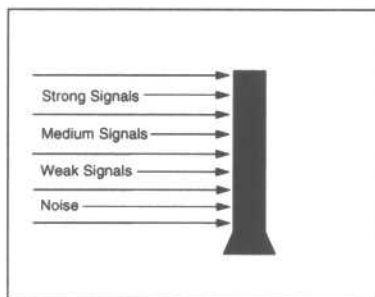
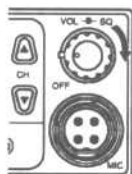

3. If you turn the SQUELCH fully counterclockwise it lowers the "Squelch Gate" so that everything gets through - noise, weak signals, and strong signals.

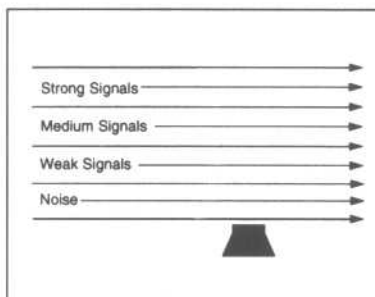
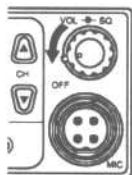

- To set the "Squelch Gate" to the desired level, turn SQUELCH counterclockwise until you hear noise. Then turn the SQUELCH clockwise just until the noise stops. Now only strong signals get through.

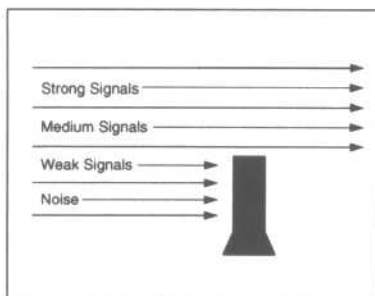
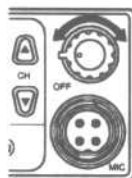

Selecting a Channel

- When you turn on the UH-088, the last channel used will appear on the LCD display.
eg. CH01

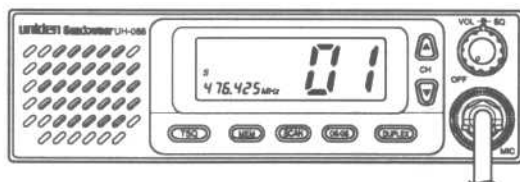

- Press ▲ to select a higher channel.

- or -

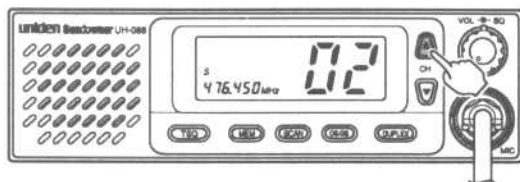

- Press ▼ to select a lower channel.

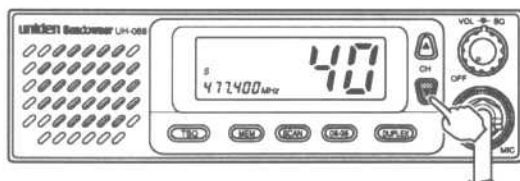

Channel Auto Step

To quickly change channels, press and hold ▼ or ▲ .

Note: A short tone sounds when you press either ▼ or ▲ and the channel changes. Another tone sounds when Channel Auto step begins.

Transmitting

The UH-088 transmits on 40 UHF CB channels. For your reference, a listing of all the available channels is printed on the back cover.

1. Select the desired channel.

eg. CH01



2. To transmit, press the **PTT** switch to activate the transmitter.

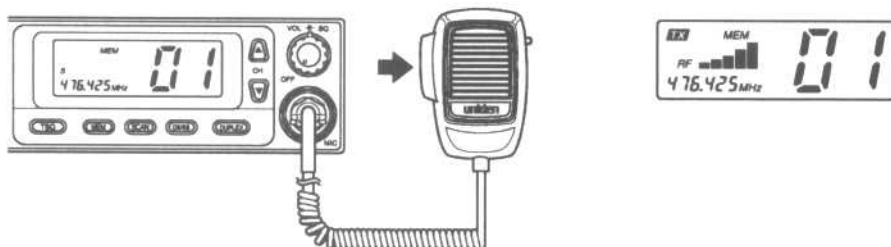

Note: Hold the microphone 5-10 cm from your mouth and slightly to one side so that your voice does not project directly into the microphone. Speak at a normal voice level. Never raise your voice or shout into the microphone.

3. Release the **PTT** Switch, to end the transmission and listen for the reply.



Using Repeater Channels

UHF CB Repeaters are used to retransmit or relay your signal. Repeaters will extend the range of your radio and overcome the shielding effect caused by solid obstructions.

In normal Simplex operation, your radio transmits on one particular frequency and receives on that same frequency. If there is a barrier (i.e. valley) that partially blocks your transmitted signal, the probability of another radio receiving the signal is very slim. Valleys, tall buildings, metallic structures, ... etc. tend to act as a screen between radios.

Standard Operation without the aid of a repeater Station

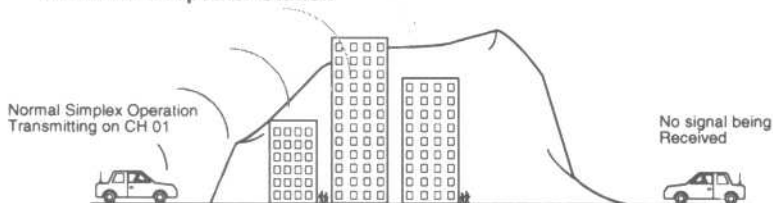

Operation with the aid of a repeater

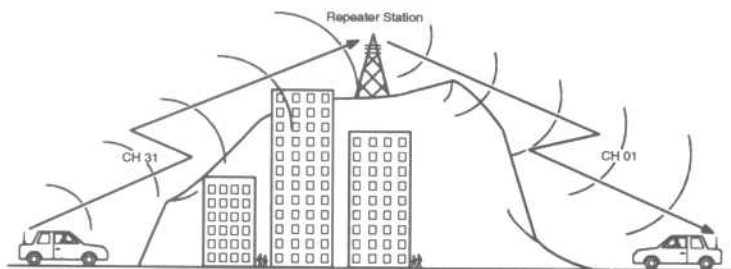

The Signal coming from your radio is received by the Repeater Station and then re-transmitted at the same time on another channel. This operation is called "Duplexing". Your UH-088 is designed with the capability to access and use repeater stations.

Channels 01 through 08 have the option to operate in Duplex Mode. When any of these channels are set to operate in duplex mode during transmission, the UH-088 automatically sends the signal at a frequency 30 channels above the original. After transmitting, the radio reverts back to its original operating frequency.

For example,

- CH01 on Duplex Mode will Receive on CH 01 but Transmit on CH31
- CH02 on Duplex Mode will Receive on CH 02 but Transmit on CH32 etc....

If you transmit on CH01 Duplex mode, you are actually transmitting on CH31, the repeater station down-converts your signal and retransmits on CH01.

To operate UH-088 in Duplex Mode,

eg. CH01 is being used in your area for repeater use.

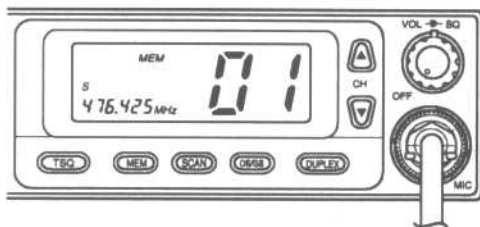

Press **DUPLEX** momentarily.
The **DUP** icon appears.

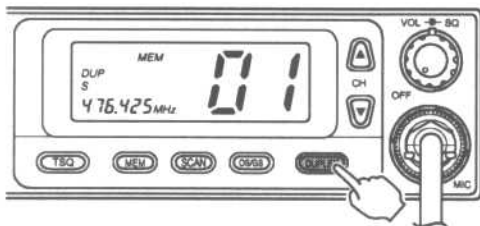

Whenever you press the **PTT** Switch the UH-088 frequency display changes to CH31 frequency.

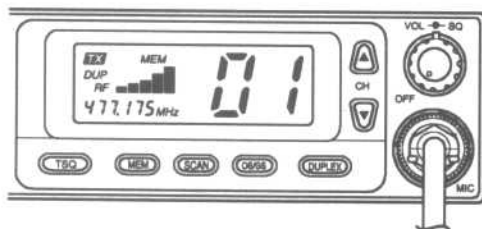

Press **DUPLEX** again to deactivate the Duplex Operation. UH-088 will return to Simplex operation.

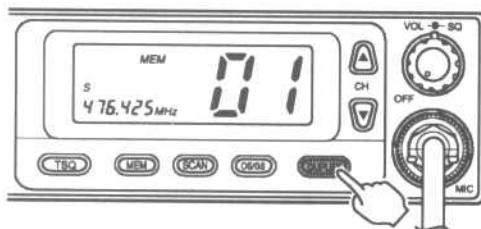

Scanning

The UH-088 has a scanning feature that allows you to search for active channels automatically.

Furthermore, the UH-088 is designed to have two types of scanning; Open Scanning (OS) and Group Scanning (GS), to give you flexibility and allow you to use the radio more effectively.

To initiate scanning.

1. Assuming the unit is on CH17 when switched on.

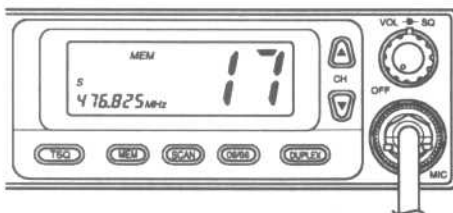

2. Press **SCAN** and Scanning starts.

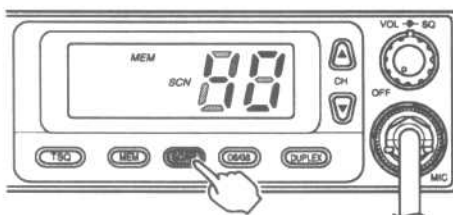

1. Open Scan (OS) Mode

Allows continuous scanning of channels stored in the Open Scan memory. If an active channel is found, scanning will stop on that channel.

Example. CH40 becomes active.

If the received signal ceases, the unit will wait for at least 3 seconds for the signal to return, otherwise scanning resumes.

To skip the active channel, press **MEM** momentarily. Scanning resumes.

To deactivate SCAN, press the **SCAN** switch or the **PTT** Button.

Note: If SCAN is deactivated while in an active channel, the UH-088 will stay on that active channel. If no other channels are active, the UH-088 will reinstate the starting channel.

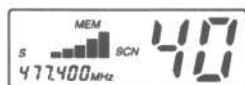

2. Group Scan (GS) Mode

Allows you to monitor a Priority Channel while scanning.

To use GS Mode Scanning, press the **OS / GS** key.

GS icon appears on the display. OS Mode is indicated by the absence of the **GS** icon.

GS Scanning checks the Priority channel activity regularly.

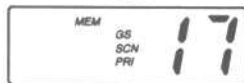

If the Priority channel becomes active the radio will stay on that channel for as long as the signal is present. If the received signal ceases, Priority scanning continues after 3 seconds.

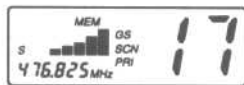

If scanning stops on a channel which is not a Priority Channel, UH-088 will continue monitoring the Priority Channel for activity while listening to the active one.

eg. CH40 becomes active.

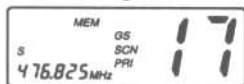
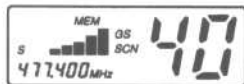

To deactivate SCAN, press the **SCAN** key or the **PTT** Switch.

Note: If SCAN is deactivated while it is tuned at an active channel, the UH-088 will stay on that active channel. If none of the channels are active, the UH-088 will reinstate the Priority channel.

If GS Scanning is initiated when there are no channels programmed in GS memory, an error tone will be heard and scanning will not start.

Choosing a Priority Channel

The starting channel, when Group Scanning is initiated, is always the Priority Channel.
Changing the PRI channel setting while scanning,
eg. PRI Channel is CH17 (476.825 MHz)

- a. press ▲ , to select a higher channel (scanning pauses)



- b. press ▼ , to select a lower channel

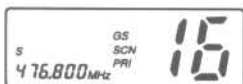

Drop-Out Delay

While scanning, the UH-088 stops at a busy channel and receives a transmission. When the received signal is over, the unit will wait for three seconds for the return of the signal, otherwise, the radio resumes scanning.

Programming Scan Channels

1. Select which Scanning Mode you wish to use on the channel.

OS or GS Mode

Note: *OS* is indicated by the absence of the **GS** icon.

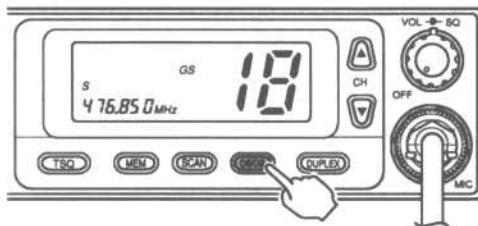

2. Select the channel you want to store.

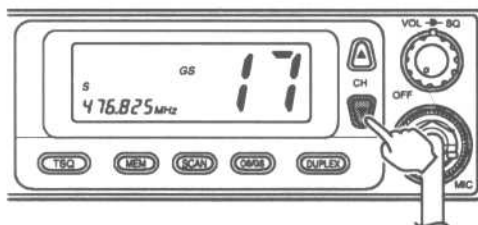

3. Press and hold **MEM** for 1.5 sec. to store. **MEM** icon appears and a short tone beep is heard.

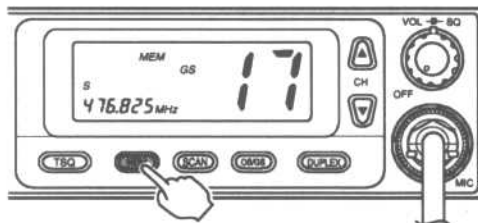

4. To remove the channel from Memory, press and hold **MEM** for 1.5 sec. once more. Two successive beeps are heard and the **MEM** icon disappears.

Channel Seeking Operation

Unlike normal scanning, CHANNEL SEEK is used more often when checking for active channels.

If a signal is detected, while seeking, the UH-088 will tune to that signal for 4 seconds only and then resumes Seeking Operation.

Changing from SCAN to SEEK Mode operation.

1. Firstly, activate SCAN mode.



2. Press and hold **SCAN** until a "beep" is heard. The **SCN** icon starts to flash.



3. If an active channel is detected the UH-088 will stop on that channel for 4 seconds. (eg. CH17)

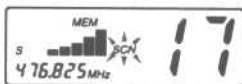

4. After 4 seconds, the UH-088 will start seeking again for active channels.



5. If you find the channel interesting, simply press either the **PTT** switch or the **SCAN** key to stop the operation before the 4 second timer elapses.



When **SCAN** is pressed again SEEK is still the mode of operation.

To change back to SCAN, while SEEKING, press and hold **SCAN** until a beep is heard. The **SCN** icon stops flashing.



Note: *SEEK checks the same channel stored in SCAN memory. Thus, you can Seek either in OS or GS Mode.*

Selective Calling

When you listen to UHF CB, you will hear all the conversations going on, which can become annoying at times. Ideally you need a system that alerts you when the signal is from someone you wish to communicate with.

You want your radio to be SELECTIVE about the people you talk to!

SELECTIVE CALLING is a special Squelch System which quiets your receiver unit until it receives an encoded signal from another set which matches the one installed in your set.

This means your set will remain quiet until the station you want to hear calls.

- Note:**
- *SELCALL is not initially installed in your set (each has to be individually programmed), but may be purchased as an option.*
 - *When you install SELCALL option, you should cut the Jumper wire (W1) inside the UH-O88.*

Tone squelch (Receiver Quieting)

Receiver Quieting, or Tone Squelch (TSQ), is actually SELCALL in action. When activated, the UH-088 receiver is muted and you cannot hear any signals until the mute is disengaged by reception of your Selcall code.

Refer to page 8 for explanation of how the squelch system works.

The Squelch discussed previously "screens" the received signal level, however in tone squelch mode, the squelch monitors the signal for your ID.

1. The Tone Squelch Control acts as an electronic lock. Activating the Tone squelch closes this lock.

Regardless of how strong the received signal is, if it does not have the required "electronic key" the gate will remain closed.

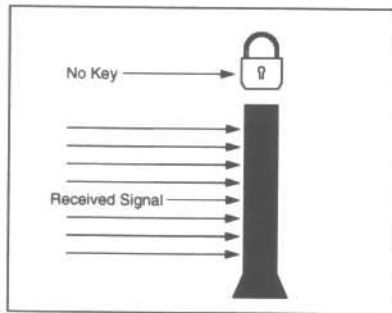

2. If the received signal contains the required key (which is your Radio ID), this electronic lock will open.

The muting circuit is then deactivated on your radio and advises you that a call has been received.

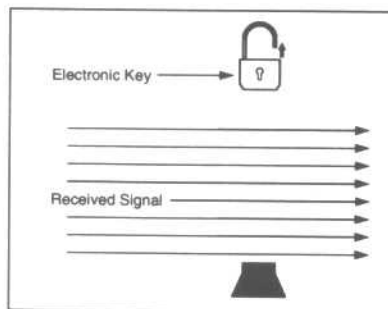

Activating the Tone Squelch (Receiver Quieting)

1. Press the **TSQ** button. One beep is heard and the **TSQ** indicator appears on the display. UH-088 is now programmed to operate in Quiet Mode.



In this mode, the microphone PTT is disabled until a signal with your Selcall ID is received.

2. To deactivate quiet mode, press the **TSQ** button again. Two beeps are heard and the **TSQ** indicator disappears from the display.

Pressing the SELCALL button will also deactivate Quiet Mode.

Receiving Calls when in Quiet Mode

The UH-088 will respond in the same way in Quiet Mode as when it is called while in normal mode.

Tone Squelch Scanning

To activate this feature, you can either initiate **SCAN** first then press **TSQ** or vice versa.

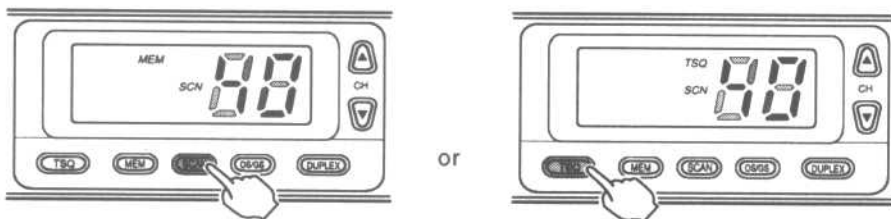

When a valid call is received, the unit cancels Tone Squelch scanning and an audible alarm is emitted.

To deactivate Tone Squelch scanning, simply press **SCAN** and/or **TSQ** key.

Note: In order to increase the chance of being reached via SELCALL while Tone Squelch scanning, it is advisable to minimize the number of channels in the scan memory.

SELCALL Programming

Please refer to the installation/programming procedure of the Optional Selcall Board.

Service

Should you find it desirable or necessary to service your UH-088, we suggest you contact the Uniden Dealer where your purchase was made. Your dealer will be able to assist you with complete service information.

If you require service that is within the terms of your warranty, you should present a copy of your receipt to your dealer to authenticate your claim.

If you find it inconvenient to obtain service assistance from a dealer, please pack your radio in a suitable container that will provide adequate protection. Enclose a note describing the problem and a copy of your receipt, and send the radio transportation prepaid to:

Uniden Australia Pty Limited
Customer Service Division
345 Princes Highway
Rockdale NSW 2216
Ph. (02) 9599-3100
Fax (02) 9599-3278

Care and Maintenance

Notice

If the UH-088 has been subjected to extreme high temperature (above 60°C) for a prolonged period of time, blackening of the Liquid Crystal Display (LCD) may occur. This is not a fault. Normal LCD operation resumes when the temperature stabilizes back to standard operating conditions (0 to 55°C).

Preventive Maintenance

The following system checks should be made every six to twelve months:

1. Check the Standing Wave Ratio (SWR).
2. Inspect the tightness of all electrical connections.
3. Inspect the antenna coaxial cable for wear or breaks on the shielding.
4. Inspect the tightness of all screws and other mounting hardware.

Troubleshooting

Should the unit malfunction or perform poorly, follow the procedures indicated below:

1. If the transceiver is completely inoperative...
 - * Check the power cord and fuse.
2. If there is trouble with receiving...
 - * Check the VOLUME control setting.
 - * Be sure the SQUELCH is adjusted properly. Possibly the radio is over-squelched.
 - * Check that the radio is in an operational mode.
3. If there is trouble with transmitting...
 - * Check that the transmission line (coaxial cable) is securely connected to the **ANTENNA** connector.
 - * Check that the antenna is fully extended for proper operation.
 - * Check that all transmission line (coaxial cable) connections are secure and free of corrosion.

Memory Backup

A built-in capacitor protects the channels stored in the SUNDOWNER UH-088 memory for up to 2 weeks after the DC power cable is disconnected.

UHF CB Channel Information

This radio has been designed to provide a high level of performance in the Citizens Band Radio Service, which is comprised of the following frequency assignments:

SIMPLEX Operating Mode

Channel	Channel Frequency in MHz
1	476.425
2	476.450
3	476.475
4	476.500
5	476.525
6	476.550
7	476.575
8	476.600
9	476.625
10	476.650
11	476.675
12	476.700
13	476.725
14	476.750
15	476.775
16	476.800
17	476.825
18	476.850
19	476.875
20	476.900
21	476.925
22	476.950
23	476.975
24	477.000
25	477.025
26	477.050
27	477.075
28	477.100
29	477.125
30	477.150
31	477.175
32	477.200
33	477.225
34	477.250
35	477.275
36	477.300
37	477.325
38	477.350
39	477.375
40	477.400

DUPLEX Operating Mode

Channel Assignment	Receive Frequency (MHz)	Transmit Frequency (MHz)
CH1	476.425	477.175 (CH31)
CH2	476.450	477.200 (CH32)
CH3	476.475	477.225 (CH33)
CH4	476.500	477.250 (CH34)
CH5	476.525	477.275 (CH35)
CH6	476.550	477.300 (CH36)
CH7	476.575	477.325 (CH37)
CH8	476.600	477.350 (CH38)

Specifications

General

Channels	: 40
Frequency Range	: 476.425MHz to 477.40MHz
Crystal Oscillator	: 4
Microphone	: 600 ohm, Dynamic Type
Speaker	: 8 ohm, 3.5W
Antenna Connector	: M-Type
Jacks & Connectors	: Mic 4P Metal EXT SP 3.5φ DC Power 2P Type
Controls	: PRESS-TO-TALK Button (Microphone) TONE CALL Button (Microphone) SCAN/SEEK Button OS/GS Button OFF/VOLUME Control SQUELCH Control MEMORY Button DUPLEX Button TONE SQUELCH Button CHANNEL UP/DOWN Button
Indicators	: DUPLEX Indicator TX Indicator CALL indicator TSQ Indicator GROUP SCAN Indicator MEMORY Indicator CHANNEL Indicator PRI Indicator S/RF Level Indicator SCAN Indicator TX/RX FREQUENCY, Indicator
Cabinet Size	: W : 172 mm H : 52 mm D : 145 mm
Weight	: 1.0 kg
Operating Temperature	: 0° to +55°C
Power Requirements	: 13.8 VDC Nominal
SMA Approval	: Type accepted under AS/NZS 4365
Accessories	: DC power cable with built-in-fuse, microphone, microphone hanger, mounting bracket screw (2), washer (2) for microphone hanger, microphone hanger screw (2), washer star (2) for mounting bracket, rubber washer (2) for mounting bracket, knob (2) for mounting bracket

Measurement Conditions

Power Source	: 13.8V (DC)
Antenna Impedance	: 50 ohm
Test Temperature	: 25°C
Modulation Frequency	: 1 kHz (RX/TX)
Mean Signal Input Level	: 1000 μ V
Reference Audio Output Power	: 500mW
Reference Modulation Deviation	: \pm 3 kHz deviation
Audio Output Load	: 8 ohms resistive

Transmitter Section

Frequency Tolerance at 25°C (5 minutes after turning on)	: \pm 0.5 kHz
Carrier Power	: 5W (max)
Spurious Emission	: -40 dBm
Current Drain	: 1500mA
Modulation Frequency Response (1 kHz, 0 dB reference, at 1 kHz deviation)	
Lower at 500 Hz	: -6 dB
Upper at 2.0 kHz	: +5 dB
Microphone Sensitivity for 3 kHz Deviation	: 1.5mV
Maximum Deviation	
at 1 kHz	: \pm 4.5 kHz
at 6 kHz	: \pm 1.5 kHz (max)

Receiver Section

Sensitivity at 12dB SINAD	: 0.23 μ V or better
Overall Audio Fidelity (1 kHz, 0 dB reference)	:
Lower at 500 Hz	: +4 dB
Upper at 2 kHz	: -6 dB
Adjacent Channel Selectivity (\pm 25 kHz)	: 70 dB
Maximum Audio Output Power	: 3W
Audio Output Power at 10% THD	: 2W
Hum & Noise Ratio at Input 1mV	: 45 dB
Squelch Sensitivity at Threshold	: 0.1 μ V
Squelch Sensitivity at Tight	: 1 μ V
Image Rejection Ratio	: 55 dB
IF Rejection Ratio	: 100 dB
Oscillator Dropout Voltage	: 9V

Current Drain at No
Signal : 350mA
Current Drain at
Maximum Output : 550mA

SELCALL OPTION

S1506 sigtec IC by Signalling Technology Pty. Ltd.

Warranty

Uniden Sundowner UH-088 UHF CB Radio
Australian One Year Warranty

Note: Please keep your sales docket as it provides evidence of warranty.

WARRANTOR: UNIDEN Australia Pty. Limited ACN 001 865 498

ELEMENTS OF WARRANTY: UNIDEN warrants to the original retail owner for the duration of this warranty, its Sundowner UH-088 UHF CB Transceiver Radio (hereinafter referred to as the Product) to be free from defects in materials and craftsmanship with only the limitations or exclusions set out below.

WARRANTY DURATION: This warranty to the original retail owner only, shall terminate and be of no further effect ONE(1) Year after the date of original retail sale. This warranty will be deemed invalid if the product is; (A) Damaged or not maintained as reasonable and necessary, (B) Modified, altered or used as part of any conversion kits, subassemblies, or any configurations not sold by Uniden, (C) Improperly installed, (D) Repaired by someone other than an authorized Uniden Repair Agent for a defect or malfunction covered by this warranty, (E) Used in conjunction with any equipment or parts or as part of a system not manufactured by Uniden, (F) Installed, programmed or serviced by anyone other than an authorized Uniden Repair Agent, or (G) Where the Serial Number label of the product has been removed or damaged beyond recognition.

PARTS COVERED: This warranty covers for 1 year, the Sundowner UH-088 UHF CB Transceiver Unit only. All accessories, mounting bracket, DC cable, fuse, and microphone are covered for 90 days.

STATEMENT OF REMEDY: In the event that the product does not conform to this warranty at any time while this warranty is in effect, the warrantor at its discretion, will repair the defect or replace the product and return it to you without charge for parts and service. THIS WARRANTY DOES NOT COVER OR PROVIDE FOR THE REIMBURSEMENT OR PAYMENT OF INCIDENTAL OR CONSEQUENTIAL DAMAGES.

WARRANTY CARD: If a warranty card has been included with this product, please fill it in and return it to us within 14 days of purchase. Your name and serial number of the product will then be registered in our database and this will help us process your claim with greater speed and efficiency should you require warranty service.

PROCEDURE FOR OBTAINING PERFORMANCE OR WARRANTY: In the event that the Product does not conform to this warranty, the Product should be shipped or delivered, freight prepaid, with evidence of original purchase, (eg/ a copy of the sales docket, to the warrantor at:

UNIDEN AUSTRALIA PTY, LIMITED
SERVICE DIVISION
345 Princes Highway, Rockdale, NSW 2216
Ph (02) 9599 3100 FAX (02) 9599 3278

Customers in other states should ship or deliver the Product freight pre-paid to the nearest Uniden Authorized Repair Centre.
(Contact Uniden for the Warranty Agent nearest you.)

uniden®

Australia Pty. Ltd.

345 Princes Highway, Rockdale, N.S.W.2216

Phone:(02) 9599 3100

Fax:(02) 9599 3278

Uniden® is a registered trademark of *Uniden Corporation*.
Features, specifications, and availability of optional accessories are all
subject to change without notice.

Free Manuals Download Website

<http://myh66.com>

<http://usermanuals.us>

<http://www.somanuals.com>

<http://www.4manuals.cc>

<http://www.manual-lib.com>

<http://www.404manual.com>

<http://www.luxmanual.com>

<http://aubethermostatmanual.com>

Golf course search by state

<http://golfingnear.com>

Email search by domain

<http://emailbydomain.com>

Auto manuals search

<http://auto.somanuals.com>

TV manuals search

<http://tv.somanuals.com>