

Uniden®

OWNER'S MANUAL



**UNIDEN Model UH-089
FRS CB Radio**

Contents

Introduction	
Features	2
Preventive Maintenance	2
Troubleshooting	2
Memory Backup	3
Controls / Connectors.....	3
Indicators.....	4
Included with Your UH-089.....	5
Operation	
Setting the FM Squelch	6
Monitor	6
Selecting a Channel.....	7
Transmitting	7
Call Function.....	7
Using Repeater Channels.....	7
Operating the UH-089 in Duplex Mode	8
Scanning	8
Open Scan (OS) Mode.....	8
Group Scan (GS) Mode	9
Programming Scan Channels.....	9
Selecting the Call Ring tone.....	10
Roger Beep(VOX Only).....	10
Busy Channel Lockout	10
VOX Operation (optional VOX headset required)	11
Programming the Instant Priority Channel	11
Recalling the Instant Channel	11
CTCSS.....	11
Frequency & CTCSS Tone Lists	12
Specifications	13
Technical Support and Service	13
Warranty.....	14

Introduction

The Uniden UH-089 is designed to provide you with years of trouble free service. Its rugged components and materials are capable of withstanding harsh environments.

We are certain that you will enjoy your UH-089. Please read this Operating Manual carefully to ensure you gain the optimum performance of the unit.

Features

- Transmit & Receive FM 40CH (UHF-CB, TX Power 5w)
- LCD Display with Backlight
- Signal Strength Meter
- RF Power Meter
- Speaker Audio Volume Level Meter
- Instant Channel
- One touch Instant Channel recalling
- Duplex Capability (from CH01 - CH08 per channel)
- Group Scan and Priority Channel Watch
- Open Scan
- Scan Channel Memory On/Off separately with Open Scan, Group Scan.
- Open Scan and Group Scan
- Rotary Channel Select
- Busy Channel Lock-out Function
- Roger Beep Function On/Off (VOX Mode Only)
- 2 Different Ring Tones
- 38 Built-in CTCSS (Continuous Tone Coded Squelch System) codes that are user selectable
- Variable Squelch Level adjust
- Volume Control with Power On/Off Switch
- VOX (Voice Activated Function)
- 10 Steps VOX Mic sensitivity adjustment

Preventive Maintenance: The following system checks should be made every six to twelve months:

- Check the Standing Wave Ratio (SWR).
- Inspect the tightness of all electrical connections.
- Inspect the antenna coaxial cable for wear or breaks on the shielding.
- Inspect the tightness of all screws and other mounting hardware.

Troubleshooting: Should the unit malfunction or perform poorly, follow these procedures:

If the transceiver is completely inoperative...

- Check the power cord and fuse.

If there is trouble with receiving...

- Check the VOLUME control setting. Be sure the SQUELCH is adjusted properly. Possibly the radio is over-squelched.

If there is trouble with transmitting...

- Check that the transmission line (coaxial cable) is securely connected to the ANTENNA connector.
- Check that the antenna is fully extended for proper operation.
- Check that all transmission line (coaxial cable) connections are secure and free of corrosion.

NOTE

Blackening may occur on the Liquid Crystal Display. If the UH-089 has been subjected to extreme high temperature (above 60°C). This is not a fault. Normal LCD operation resumes when the temperature stabilizes back to standard operating conditions (0 to 55°C).

Memory Backup: A built-in capacitor protects the channels stored in the UH-089 memory for up to 2 weeks after the DC power cable is disconnected.

Controls / Connectors

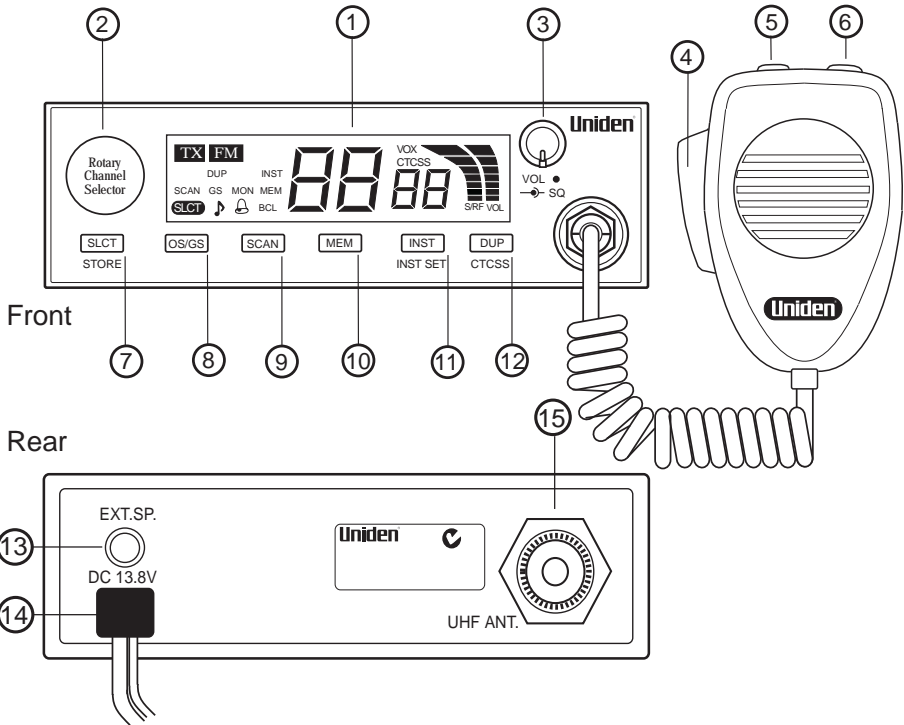

Controls and Connections

Ref.	Item	Page	Ref.	Item	Page
①	Liquid Crystal Display (LCD)	4	⑨	SCAN - Scan On/Off	8, 9
②	Rotary Channel Selector	7	⑩	MEM - Memory Scan Channels	8, 9
③	On/Off Volume & Squelch	6	⑪	INST - Instant Channel Recall and Instant Channel Programming	11
④	Push to Talk (PTT) Switch	7	⑫	DUP - CTCSS Tone and Duplex On/Off	11
⑤	Call Button	7	⑬	Extension Speaker Jack	-
⑥	Monitor Button	6	⑭	Power Input (13.8V DC)	-
⑦	SLCT/STORE - Select Button	10	⑮	UHF Antenna Connection	-
⑧	OS/GS - Open or Group Scan	9			

Indicators

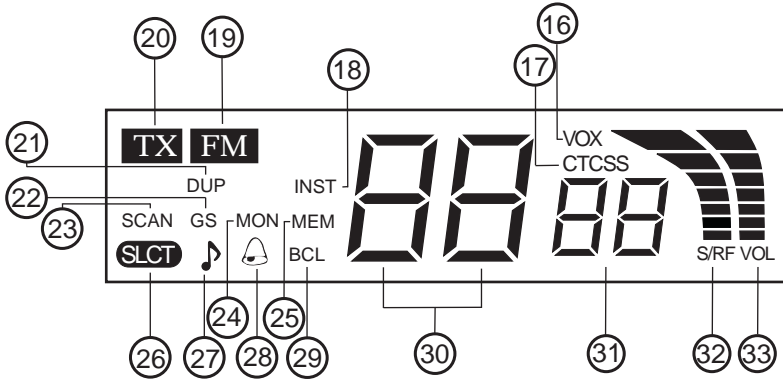

Indicators

Ref.	Item	Page	Ref.	Item	Page
16	VOX - Voice Operated Microphone	10	25	MEM - Memory	9
17	CTCSS - Continuous Tone Coded Squelch System	11	26	SLCT - Select	10
18	INST - Instant Channel	11	27	♪ - Ring tone	10
19	FM - FM Mode	6 - 13	28	🔔 - Roger Beep	10
20	TX - Transmit	7	29	BCL - Busy Channel Lockout	10
21	DUP - Duplex	8	30	88 - Channel number	7
22	GS - Group Scan	9	31	88 - CTCSS Code Number	9
23	SCAN - Scan mode	8	32	S/R/F - Receive Signal or Transmit RF Power Level Meter	-
24	MON - Monitor	6	33	VOL - Receive Audio Volume Level Meter	-

Included with your UH-089



UH-089 Owners Manual

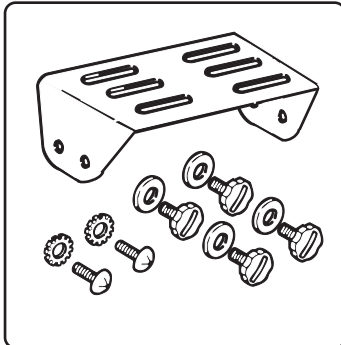

Mounting Bracket, Knobs, Rubber Washer, Washer Stars and Screws

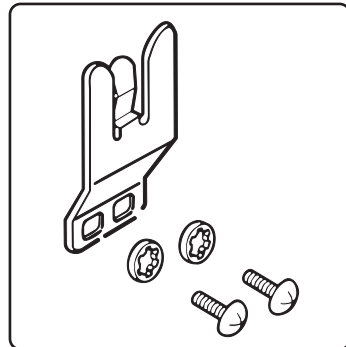

Microphone Hanger, Screws and Washers

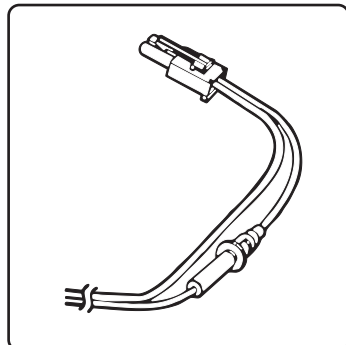

DC Power Cord with Fuse

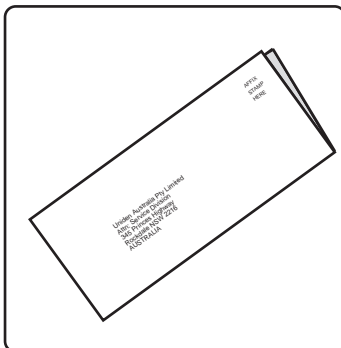

Warranty Registration Sheet

Operation

Setting the FM Squelch

Turn the Unit ON by rotating the volume control clockwise. Turn the outer ring of the control to adjust the Squelch.



You must select a channel which is not in use before setting the SQUELCH control (see p.7)

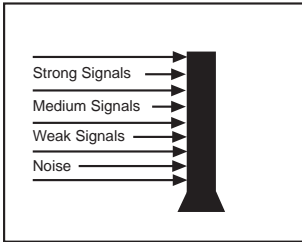
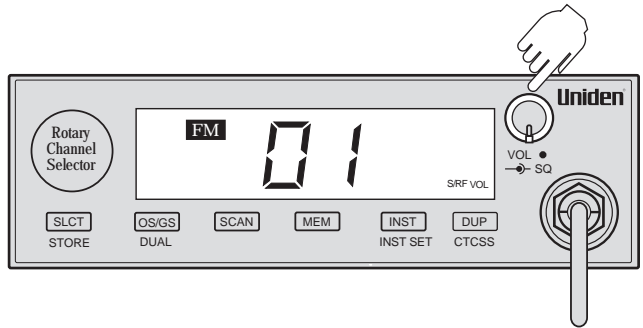

Think of the squelch control as a gate. If you turn Squelch fully clockwise it raises the 'Squelch Gate' so high that no signals get through.

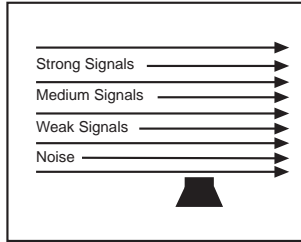

If you turn Squelch fully counterclockwise it lowers the 'Squelch Gate' to the extent that all signals get through - weak, medium and strong signals and noise.

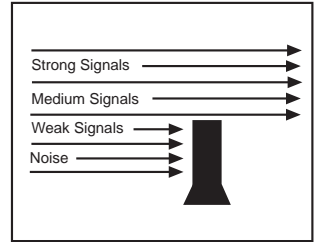

To set the 'Squelch Gate' to the desired level, turn the squelch knob counterclockwise until you hear noise. Then carefully turn the Squelch knob clockwise until the noise fades. Now only strong signals get through.

Monitor

Press the MONI button on the microphone to open the squelch and receive all weak signals. Press and hold the MONI button for 3 seconds to hold the squelch open. Press MONI again momentarily to cancel.

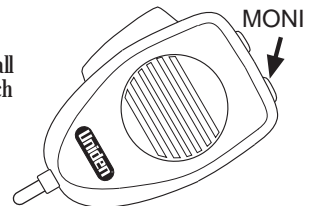

Operation

Selecting a Channel

Turn the Rotary Channel Selector to select the desired channel.

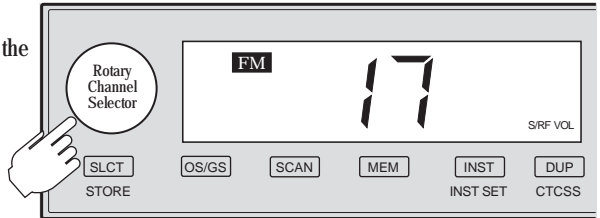

Transmitting

Select the desired channel. Press the Microphone's PTT button and speak normally into the microphone. Hold it approx. 7cm from your mouth. Release the PTT button to end the transmission and listen for a reply.

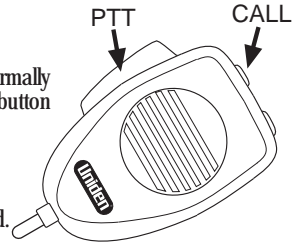

Call Function

Press the microphone Call Button. A two second ringing tone will be transmitted. You may select from 2 types of ring tones (see p.10).

Using Repeater Channels

UHF CB Repeaters are used to retransmit or relay your signal. Repeaters will extend the range of your radio and overcome the shielding effect caused by solid obstructions. In normal Simplex operation, your radio transmits on one particular frequency and receives on that same frequency. If there is a barrier that partially blocks your transmitted signal, the probability of another radio receiving the signal is very slim. Hills, tall buildings, metallic structures, ... etc. tend to act as a screen between radios.

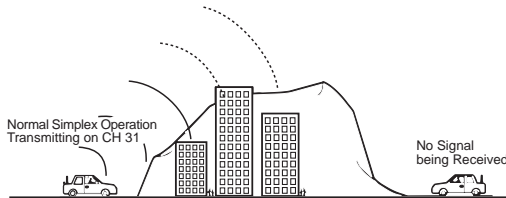

Normal Simplex Operation
Transmitting on CH 31

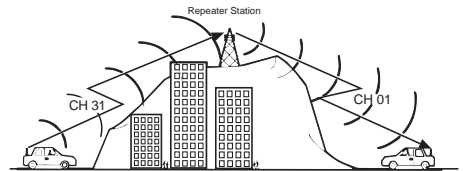

Operation with the aid of
Repeater Station (Duplex)

The Signal coming from your radio is received by the Repeater Station and then retransmitted at the same time on another channel. This operation is called "Duplexing".

For example,

CH01 on Duplex Mode will Receive on CH 01 but Transmit on CH31

CH02 on Duplex Mode will Receive on CH 02 but Transmit on CH32 etc

If you transmit on CH01 Duplex mode, you are actually transmitting on CH31, the repeater station down-converts your signal and retransmits on CH01.

Operation

Operating the UH-089 in Duplex Mode

For this example we are adopting CH01 as the channel being used in your area for repeater use.

Press **[DUP]** to switch Duplex On. The DUP icon appears.

If Duplex is not required - press **[DUP]** again to switch Duplex off.

Only channels 01 - 08 are available for Duplex

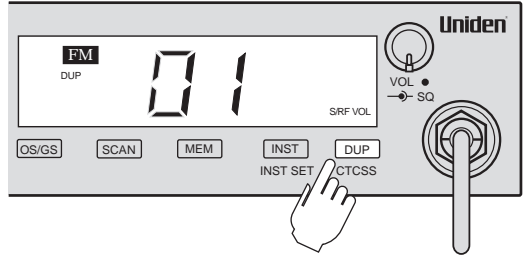

NOTE

Check with your local Retailer to determine if there is a Repeater in your area.

Scanning

The UH-089 has a scanning feature that allows you to search for active channels automatically.

Furthermore, the UH-089 is designed to have two types of scanning; Open Scanning (OS) and Group Scanning (GS), to give you flexibility and allow you to use the radio more effectively.

Press **[SCAN]** and Scanning starts. The SCAN icon appears.

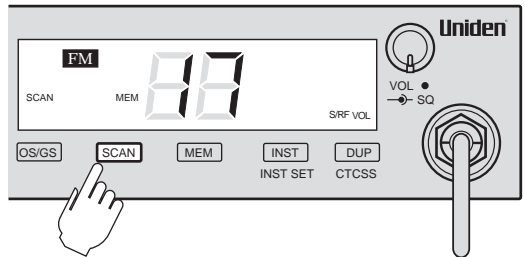

Open Scan (OS) Mode

Allows continuous scanning of channels stored in the Open Scan memory. If an active channel is found, scanning will stop on that channel.

This example shows CH40 active.

If the received signal ceases, the unit will wait 3 seconds for the signal to return, otherwise scanning resumes.

To skip the active channel, press **[MEM]** momentarily. Scanning resumes. To deactivate SCAN, press **[SCAN]** or the PTT button on the microphone.



NOTE

If SCAN is deactivated while on an active channel, the UH-089 will stay on that active channel. If no channels are active, the UH-089 will reinstate the starting channel.

NOTE

OS Mode is indicated by the absence of the GS icon.

Operation

Group Scan (GS) Mode

Allows you to monitor a Priority (Instant) Channel while scanning (Instant Priority channel see p. 11)

To use GS Mode Scanning, press **[OS/GS]**. GS icon appears on the display.



GS Scanning checks the Instant Priority Channel for activity regularly.

If the Priority Channel becomes active the radio will stay on that channel for as long as the signal is present. If the received signal ceases, Priority Scanning continues after 3 seconds.

If scanning stops on a channel which is not a Priority Channel, UH-089 will continue monitoring the Priority Channel for activity while listening to the active one.

To deactivate SCAN, press the **[SCAN]** button or the PTT button

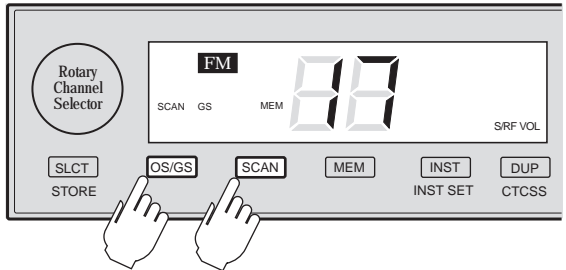

NOTE

If SCAN is deactivated while it is tuned to an active channel, the UH-089 will stay on that active channel. If none of the channels are active, the UH-089 will reinstate the Priority Channel.

NOTE

If GS Scanning is initiated when there are no channels programmed in GS memory, an error tone will be heard and scanning will not start (see Programming Scan Channels - below).

Programming Scan Channels

Select which Scanning Mode you wish to use - OS or GS.

Select the channel you want to store.

Press **[MEM]** to store. MEM icon appears and a short tone beep is heard.

To remove the channel from Memory, press **[MEM]** once more. The MEM icon disappears.

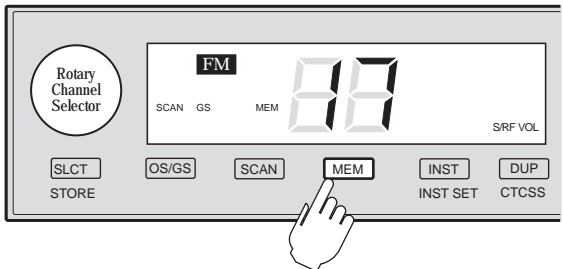

NOTE

OS is indicated by the absence of the GS icon.

Operation

Selecting the Call Ring tone

Press (SLCT) once. Turn the Rotary Channel Selector to either **A** or **B**. Press and hold (SLCT) for 3 seconds to store the new setting.

NOTE If a button is not pressed within 10 seconds the UH-089 will automatically exit Select Mode.

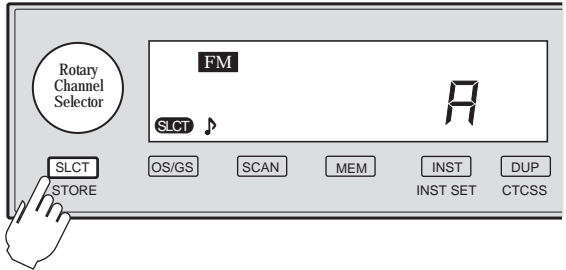

Roger Beep (VOX Only)

A Roger Beep may be added to the end of a VOX transmission. Press (SLCT) twice.

Turn the Channel Selector to display **ON**. Press and hold (SLCT) for 3 seconds to store the new setting.

NOTE If a button is not pressed within 10 seconds the UH-089 will automatically exit Select Mode.

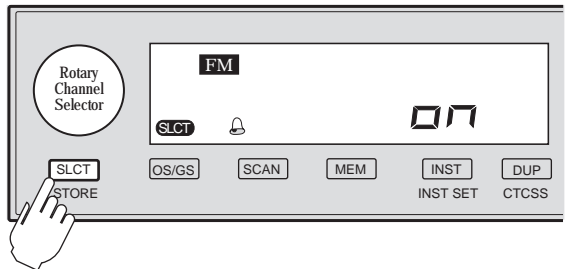

Busy Channel Lockout

If the channel is already in use, you can prevent the UH-089 from transmitting. This is particularly important when using CTCSS.

Press (SLCT) 3 times. Turn the Rotary Channel Selector to display **ON**. Press and hold (SLCT) for 3 seconds to store the new setting.

NOTE If a button is not pressed within 10 seconds the UH-089 will automatically exit Select Mode.

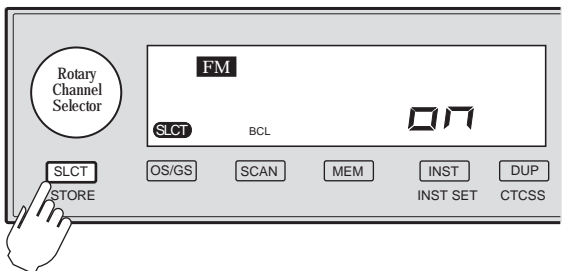

Operation

VOX Operation (optional VOX headset required)

Press **[SLCT]** 4 times. Turn the Rotary Channel Selector to select the desired VOX sensitivity (1 - 9).

Press and hold **[SLCT]** for 3 seconds to store the new setting. Connect the VOX headset.

NOTE

If a button is not pressed within 10 seconds the UH-089 will automatically exit Select Mode.

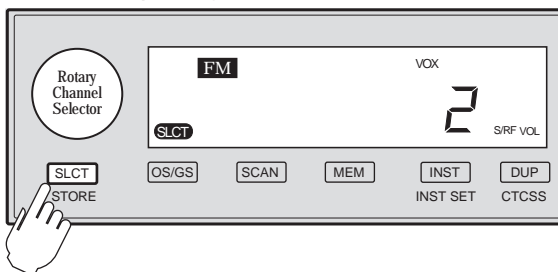

Programming the Instant Priority Channel

Turn the Rotary Channel Selector to select the Priority Channel you prefer.

Press and hold **[INST]** for 3 seconds to store the new setting. INST icon appears.

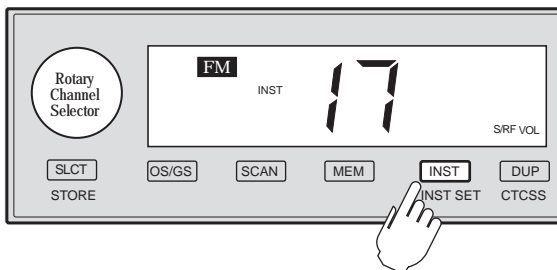

Recalling the Instant Channel

Momentarily press the **[INST]** key at any time to return to the Instant Channel.

CTCSS

Turn the Rotary Channel Selector to the desired channel to use CTCSS. Press and hold **[DUP]** for 3 seconds. CTCSS icon appears.

Turn the Rotary Channel Selector to select the desired CTCSS code 01 - 38. Press **[DUP]** once to store the new setting.

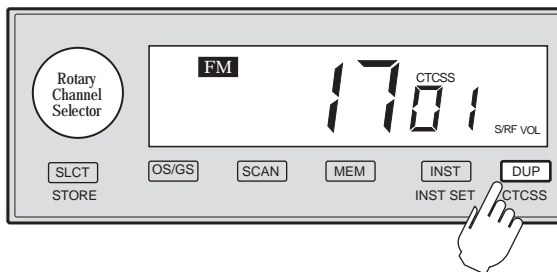

NOTE

Channels 05 and 11 are Emergency Channels. CTCSS cannot be selected on these channels.

Frequency & CTCSS Tone Lists

FM UHF - CB Frequency List

Australia & New Zealand				
CH No.	(MHz)	DUP (MHz)	CH No.	(MHz)
01	476.425	477.175 CH31	21	476.925
02	476.450	477.200 CH32	22	476.950
03	476.475	477.225 CH33	23	476.975
04	476.500	477.250 CH34	24	477.000
05	476.525	477.275 CH35	25	477.025
06	476.550	477.300 CH36	26	477.050
07	476.575	477.325 CH37	27	477.075
08	476.600	477.350 CH38	28	477.100
09	476.625		29	477.125
10	476.650		30	477.150
11	476.675		31	477.175
12	476.700		32	477.200
13	476.725		33	477.225
14	476.750		34	477.250
15	476.775		35	477.275
16	476.800		36	477.300
17	476.825		37	477.325
18	476.850		38	477.350
19	476.875		39	477.375
20	476.900		40	477.400

NOTE: Channel 05 and 11 are Emergency Channels

CTCSS TONE List

Tone No.	Tone Frequency (Hz)	Tone No.	Tone Frequency (Hz)	Tone No.	Tone Frequency (Hz)
00 ('oF')	OFF	13	103.5	26	162.2
01	67.0	14	107.2	27	167.9
02	71.9	15	110.9	28	173.8
03	74.4	16	114.8	29	179.9
04	77.0	17	118.8	30	186.2
05	79.7	18	123.0	31	192.8
06	82.5	19	127.3	32	203.5
07	85.4	20	131.8	33	210.7
08	88.5	21	136.5	34	218.1
09	91.5	22	141.3	35	225.7
10	94.8	23	146.2	36	233.6
11	97.4	24	151.4	37	241.8
12	100.0	25	156.7	38	250.3

NOTE: Channel 05 and 11 are Emergency Channels thus not CTCSS programmable.

Specifications

General		Receiver	
Channels	: 40	Sensitivity at 12dB SINAD	: 0.23uV or better
Microphone	: 600 ohm, Dynamic Type	Overall Audio Fidelity (1 Khz, 0 dB reference)	
Speaker	: 8 ohm, 3w	Lower at 500 Hz	: +5dB
Antenna Connector	: M-Type	Upper at 2 kHz	: -7 dB
Jacks & Connectors	: EXT SP 3.5mm	Adjacent Channel Selectivity (+/-25 kHz)	: 64dB
Operating Temperature	: 0° to + 55° C	Max. Audio Output Power	: 3W
Power Requirements	: 13.8 VDC Nominal	Audio Output Power at 10% HD	: 3W
Antenna Impedence	: 50 ohms	Hum and Noise Ratio at Input 1 mV	: 45 dB
Transmitter (FM)		Squelch Sensitivity at Threshold	: 0.1 uV
Frequency Tolerance at 25°C (5 minutes after tuning on)	: +/- .5 kHz	Squelch Sensitivity at Tight	: 1 uV
carrier Power	: 5W (max)	Image Rejection Ratio	: 60 dB
Spurious Emission	: -40 dBm	IF Rejection Ratio	: 100dB
Current Drain	: 1.35 Amps	Oscillator Dropout Voltage	: 9V
Modulation Frequency Response (1 kHz, 0 dB reference at 1 kHz deviation)		Current Drain at NO Signal	: 350mA
Lower at 500 Hz	: -6dB	Current Drain at Max. Output	: 730 mA
Upper at 2.0 kHz	: +5 dB		
Microphone Sensitivity for 3 kHz Deviation	: 5mV		
Maximum Deviation			
at 1 kHz	: +/- 4.5 kHz		
at 6 kHz	: +/-1.5 kHz (max)		

Technical Support and Service

Should you find it desirable or necessary to service your UH-089, we suggest you contact the Uniden Dealer where your purchase was made. Your dealer will be able to assist you with complete service information.

If you require service that is within the terms of your warranty you should present a copy of your receipt to your dealer to authenticate your claim.

If you find it inconvenient to obtain service assistance from a dealer, please pack your radio in a suitable container that will provide adequate protection. Enclose a note describing the problem and a copy of your receipt, and send the radio transportation prepaid to:

Uniden Australia Pty Limited
Customer Service Division
345 Princes Highway
Rockdale NSW 2216
AUSTRALIA

Ph. (02) 9599-3100
Fax (02) 9599-3278
Toll Free 1300 366 895

www.uniden.com.au

Uniden New Zealand Limited
Customer Service Division
150 Harris Road
East Tamaki
Auckland
NEW ZEALAND

Ph. (09) 273 8383
Fax (09) 274 0009
Toll Free 0800 486 4336

www.uniden.co.nz

Warranty

ONE YEAR LIMITED WARRANTY

IMPORTANT: Evidence of the original purchase is required for warranty service.

WARRANTOR: Uniden New Zealand Limited. Uniden Australia Pty Ltd. ACN 001 865 498

ELEMENTS OF WARRANTY: Uniden warrants to the original retail owner for the duration of this warranty its UH-089 hereinafter referred to as the Product), to be free from defects in materials and craftsmanship with only the limitations or exclusions set out below.

WARRANTY DURATION: This warranty to the original retail owner only is only valid in the original country of purchase and shall be of no further effect 12 months after the date of original retail sale. This warranty will be deemed invalid if the Product is: (A) Damaged or not maintained as reasonable and necessary, (B) Modified, altered or used as part of any conversion kits, subassemblies, or any configurations not sold by Uniden, (C) Improperly installed, (D) repaired by someone other than an authorised Uniden Repair Agent for a defect or malfunction covered by this warranty, (E) Used in conjunction with any equipment or parts or as a part of a system not manufactured by Uniden. (F) Where the Serial No. label of the product has been removed or damaged beyond recognition.

PARTS COVERED: This warranty covers for one (1) year, the UH-089 tranceiver only. All accessories (Mounting bracket, Microphone etc.) are covered for 90 days only.

STATEMENT OF REMEDY: In the event that the Product does not conform to this warranty at any time while this warranty is in effect, the warrantor, at its discretion, will repair the defect or replace the Product and return it to you without charge for parts and service. **THIS WARRANTY DOES NOT COVER OR PROVIDE FOR THE REIMBURSEMENT OR PAYMENT OF INCIDENTAL OR CONSEQUENTIAL DAMAGES. THIS GUARANTEE IS IN ADDITION TO AND DOES NOT IN ANY WAY AFFECT YOUR RIGHTS UNDER THE CONSUMER ACT.**

WARRANTY CARD: If a Warranty Card has been included with this Product, please complete and return to us within 14 days of purchase. Your name and the serial number of the Product will then be registered in our database and this will help us process your claim with greater speed and efficiency should you require warranty service.

PROCEDURE FOR OBTAINING PERFORMANCE OF WARRANTY: in the event that the Product does not conform to this warranty, the Product should be shipped or delivered, freight prepaid, with evidence of original purchase (e.g. a copy of the sales docket) to the warrantor at:

UNIDEN AUSTRALIA PTY LIMITED

SERVICE DIVISION

345 Princes Highway,
Rockdale, NSW 2216,

AUSTRALIA

Ph: (02) 9599-3100

Fax: (02) 9599-3278

Toll Free: 1300 36 895

www.uniden.com.au

UNIDEN NEW ZEALAND LIMITED

SERVICE DIVISION

150 Harris Road,
East Tamaki,
Auckland,

NEW ZEALAND

Ph: (09) 273 8383

Fax: 274 0009

Toll Free: 0800 486 4336

www.uniden.co.nz

Uniden[®]

©2001 Uniden Australia Pty Limited / Uniden New Zealand Limited
Printed in the Philippines
PPC: UTZZ01879ZZ

Free Manuals Download Website

<http://myh66.com>

<http://usermanuals.us>

<http://www.somanuals.com>

<http://www.4manuals.cc>

<http://www.manual-lib.com>

<http://www.404manual.com>

<http://www.luxmanual.com>

<http://aubethermostatmanual.com>

Golf course search by state

<http://golfingnear.com>

Email search by domain

<http://emailbydomain.com>

Auto manuals search

<http://auto.somanuals.com>

TV manuals search

<http://tv.somanuals.com>