

# Uniden®

**XDECT R055**

# OWNER'S MANUAL



# XDECT R055 Series Owner's Manual

## What's in the box?

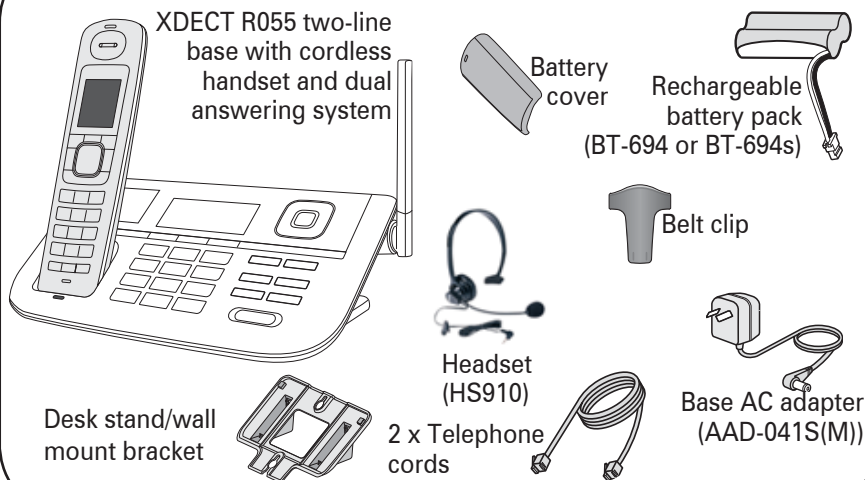

XDECT R005 accessory handset and repeater with charger



## You might also find:

Rechargeable battery pack (BT-694 or BT-694s)

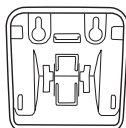
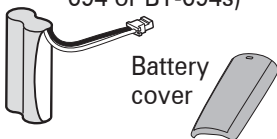

Desk stand/wall mount bracket

If you purchased model number:	You should have:
XDECT R055	None
XDECT R055+1	1 of each
XDECT R055+2	2 of each
XDECT R055+3	3 of each
XDECT R055+4	4 of each
XDECT R055+5	5 of each

Charger AC adapter (AAD-041S(M))

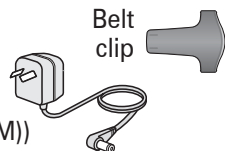

If any items are missing or damaged, contact your place of purchase. Never use damaged products!

Need Help? Get answers at our website: [www.uniden.com.au](http://www.uniden.com.au) for Australian model or [www.uniden.co.nz](http://www.uniden.co.nz) for New Zealand model.

Download from [Www.Somanuals.com](http://Www.Somanuals.com). All Manuals Search And Download.

## What's in the manual?

Installing Your Phone.....	1	Chain Dialing.....	32
Setup the Base .....	1	<b>Using Multi-station Features .....</b>	<b>33</b>
Setup the Repeater/Charger(s) (if included) .....	4	Expanding Your Phone .....	33
Setup the Handset(s).....	5	Using Multi-Station Conference Calling ..	33
Using the Belt Clip .....	6	Using Privacy Mode .....	34
Test the Connection.....	7	Using Call Transfer .....	34
Using the Repeater.....	8	Using the Intercom.....	35
<b>Getting to Know Your Phone.....</b>	<b>11</b>	<b>Using Special Features .....</b>	<b>36</b>
Parts of the Base .....	11	Using Do Not Disturb .....	36
Parts of the Handset .....	13	Using Call Block.....	36
Reading the Displays .....	15	Using the Alarm Feature .....	38
Using the Soft Keys .....	17	Using Voice Message Notification .....	39
Entering Text on Your Phone.....	19	<b>Using the Answering System .....</b>	<b>40</b>
<b>Using the Menus.....</b>	<b>20</b>	Setting Up Your Answering System.....	40
The <i>Handset and Base Setup</i> Menu	21	Getting Your Messages .....	42
The <i>Clock Setup</i> Menu.....	22	Screening Your Calls .....	43
The <i>Global Setup</i> Menu .....	22	Using the System While You're Away from Home.....	44
Special Feature Menus .....	23	<b>Solving Problems .....</b>	<b>45</b>
<b>Using Your Phone .....</b>	<b>24</b>	Weak or Hard To Hear Audio .....	47
Working with Two Lines .....	24	Noise or Static On The Line.....	47
Changing the Volume .....	26	Resetting and Registering Handsets .....	49
Using the Caller ID and Redial Lists .....	26	Registering Repeaters .....	50
Using Call Waiting.....	28	Handling Liquid Damage.....	51
Finding a Lost Handset.....	28	<b>Important Information .....</b>	<b>52</b>
Using the Headset .....	29	Battery Information.....	53
<b>Using the Phonebook.....</b>	<b>30</b>	<b>Index .....</b>	<b>54</b>
Setting Up Your Phonebook .....	30	<b>One-year Limited Warranty.....</b>	<b>55</b>
Phonebook Menu Options .....	32		

## Important Safety Instructions!

When using your telephone equipment, basic safety precautions should always be followed to reduce the risk of fire, electric shock and injury to persons, including the following:

- ♦ **This unit is NOT waterproof.** DO NOT expose this unit to rain or moisture.
- ♦ Do not use this product near water, for example, near a bath tub, wash bowl, kitchen sink or laundry tub, in a wet basement or near a swimming pool.
- ♦ Avoid using a telephone (other than a cordless type) during an electrical storm. There may be a remote risk of electric shock from lightning.
- ♦ Do not use the telephone to report a gas leak in the vicinity of the leak.
- ♦ Use only the power cord and batteries indicated in this manual. Do not dispose of batteries in a fire. They may explode. Check with local codes for possible special disposal instructions.
- ♦ Do not place the handset in any charging cradle without the battery installed and the battery cover securely in place.

# Installing Your Phone

## Setup the Base

### *Attach the stand*

Before you attach the stand, you have to decide if you want the phone to rest on a desk or hang on a wall.

1. For desktop use, turn the stand so the locking tabs that say **DESK** are facing the base with the arrows pointing up.

OR

For wall mount use, turn the stand so the locking tabs that say **WALL** are facing the base with the arrows pointing down.

2. Align the stand with the notches on the base.
3. Slide the stand onto the notches until it clicks into place.

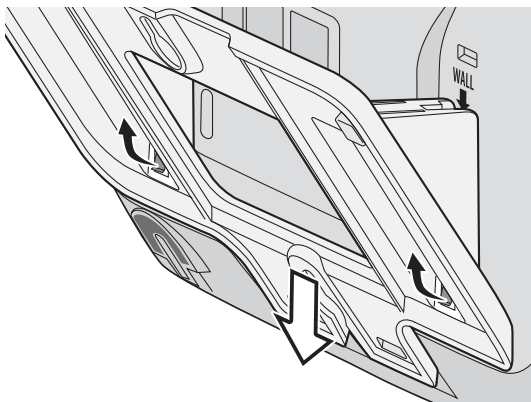
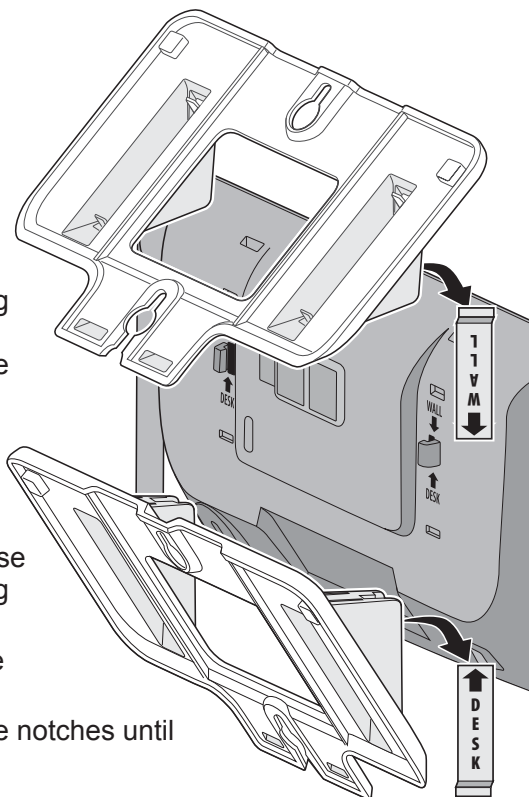

To remove the stand  
Pull the locking tabs up and back (see the black arrows in the illustration to the right). Then, slide the stand straight off the same direction you put it on.

## Connect the power and telephone cord(s)

1. Connect the base AC adapter to the **DC IN 9V** jack and route the cord as shown:

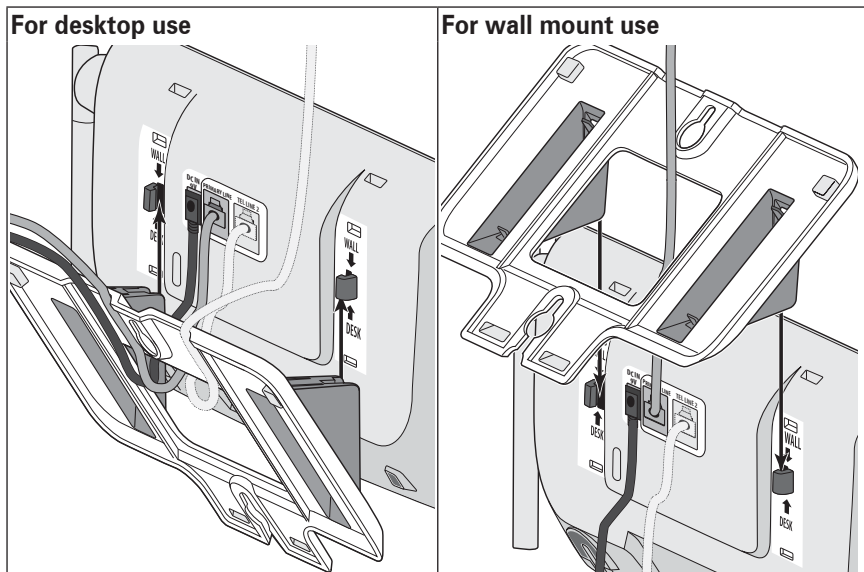

2. Connect one of the included telephone cords to the **PRIMARY LINE** jack.



If you wish to connect a second telephone line then remove the label cover to access the TEL LINE 2 jack. Connect the second telephone cord to the TEL LINE 2 jack. Route the cords as shown above.

3. Connect the cord from **PRIMARY LINE** to the phone jack for line 1; then, if you have a second telephone line, connect the cord from **TEL LINE 2** to the phone jack for line 2.
4. Plug the AC adapter into a standard 240V AC power outlet.

### ***Place the main base on the wall***

Place the mounting slots (hole spacing is 100mm vertical) over the pins on the wall plate, and slide the base down to lock it into place.

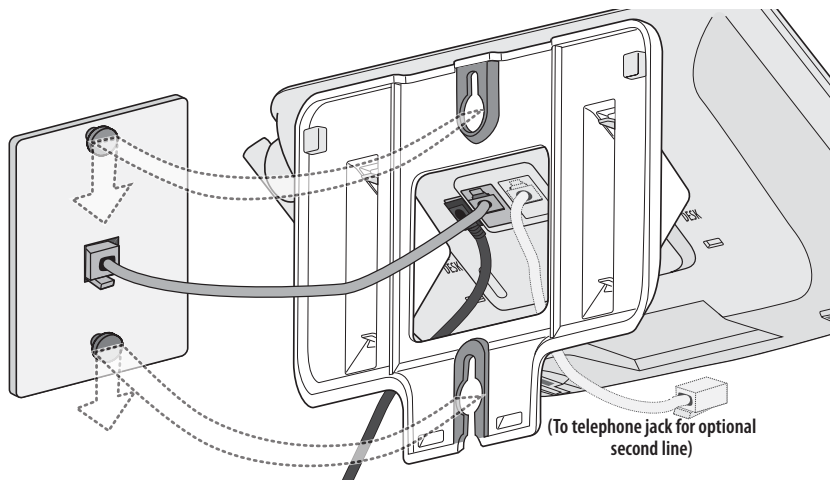

## Setup the Repeater/Charger(s) (if included)

### **Connect the repeater/charger power cord**

1. If your phone came with any accessory handsets and chargers, connect a charger AC adapter to each charger's **DC IN 9V** jack and set the plug into the notch as shown. (These adapters might already be connected.)
2. Plug the other end of the adapter into a standard 240V AC power outlet.

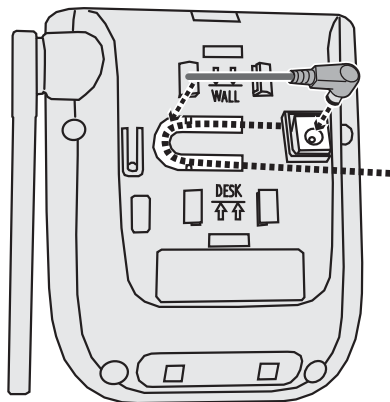

### **Attach the stand**

3. To attach the stand, you have to decide if you want the repeater to rest on a desk or hang on a wall.  
For desktop use, turn the stand so the locking tabs that say **DESK** are facing the base with the arrows pointing up.  
OR  
For wall mount use, turn the stand so the locking tabs that say **WALL** are facing the base with the arrows pointing down.
4. Align the stand with the notches on the repeater.
5. Slide the stand onto the notches until it clicks into place. (To remove the stand, pull the locking tabs up and back. Then, slide the stand straight off the same direction you put it on.)

### **Place the repeater/charger on the wall**

6. For wall mount use, place the mounting slots (hole spacing is 30mm horizontal) over the pins on the wall, and slide the base down to lock it into place.



## Setup the Handset(s)

### *Install the battery*

1. Unpack all handsets, battery packs, and battery covers. If any handset has the battery cover already attached, press in on the notch and slide the cover down and off.
2. Line up the battery pack connector with the jack inside the handset. (The battery connector will only fit one way.)
3. Push the battery pack connector in until it clicks into place. Tug gently on the wires to make sure the battery pack is securely connected.

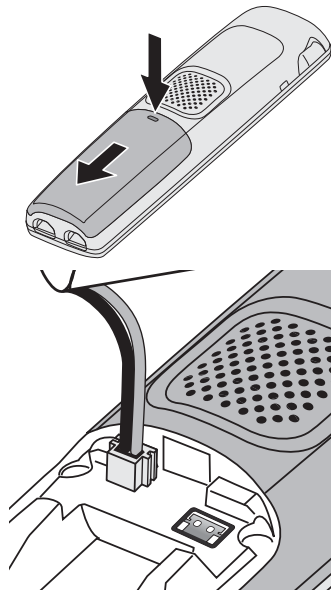
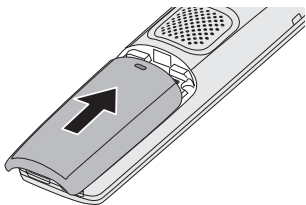

4. Place the cover over the battery compartment and slide it up into place.

### *Charge the battery*

Place one handset in the base and any other handsets in a charger with the displays facing forward. (It doesn't matter which handset you place in the base.) The **CHARGE** lights on the base and all chargers should turn on.

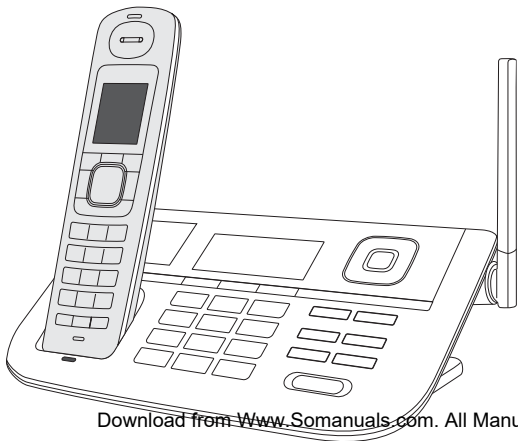

If...	Try...
a <b>CHARGE</b> light doesn't turn on	<ul style="list-style-type: none"><li>- reseating the handset.</li><li>- checking the AC adapter connection.</li></ul>

**Charge all handsets completely (about 15 hours) before using them. When fully charged the battery will provide up to 8hrs talk time and 7 days standby time.**

## **Using the Belt Clip**

### ***To attach the belt clip***

Line up the holes on each side of the handset. Insert the belt clip into the holes on each side of the handset. Press down until it clicks.

### ***To remove the belt clip***

Pull either side of the belt clip to release the tabs from the holes.

## Test the Connection

Pick up the handset from the base and press **TALK/FLASH**. The phone should pick up line 1 automatically and change the display to show *Talk* **L1**, and you should hear a dial tone.

When you get a dial tone, make a test call; press **END** to hang up.

If...	Try...
the base display says <b>L1</b> <i>Check</i> or you don't hear a dial tone	checking the connection between the base and the phone jack: make sure the cord is connected to <b>PRIMARY LINE</b> .
there's a lot of noise or static	see page 47 for tips on avoiding interference.
the handset display says <i>Unavailable</i>	resetting the handset (see page 49). If you have accessory handsets, try using a different handset for the test call.

## Test Line 2 (Optional)

If a second line is connected, make a test call on the second line. Pick up the handset and press the unmarked key under **LINE2**. You should hear a dial tone and the display should show *Talk* **L2**.



If...	Try...
the display says <b>L2</b> <i>Check</i> or you don't hear a dial tone	checking the connection between the base and the phone jack: if you have a separate jack for each line, make sure the cord is connected to <b>TEL LINE 2</b> .

Test any accessory handsets the same way. If you can't get a dial tone or the handset display says *Unavailable*, try moving the handset closer to the base or resetting it (see page 49).

# Using the Repeater

## How it works

An XDECT R005 repeater can extend the range of your base in all directions, including up and down. The XDECT R005 repeater unit is also a charger for the accessory handset.

Each handset will automatically connect to the repeater or the base, depending on which signal is stronger, and the handset operates exactly the same way whether it's connected to the base or to the repeater.

- ◆ The repeaters must be registered to the base before you can use them. Any repeaters that come packaged with the base are already registered to that base. For instructions on registering repeaters to the base, see page 50.

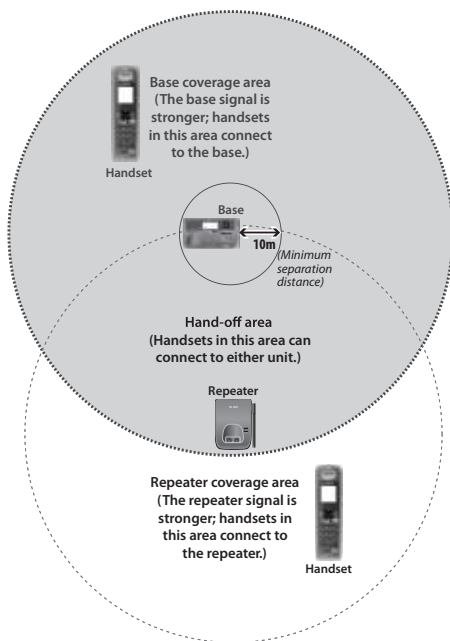

Note: Base range (grey area) and repeater range (dotted outline around repeater) is represented here as circular. Actual coverage area will vary depending on environment.

- ◆ Your base supports a total of six XDECT R005 repeaters, including any that were supplied with your phone.

- ◆ Repeaters can be up to 3 chain-links (maximum) from the base

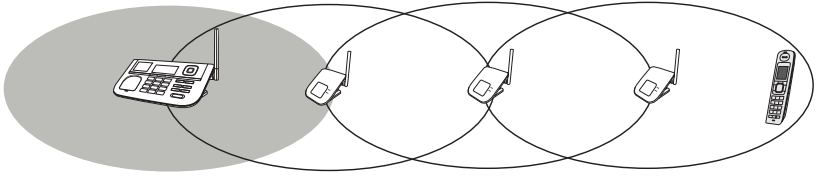

- ◆ Example of coverage area with 6 repeaters (maximum total)

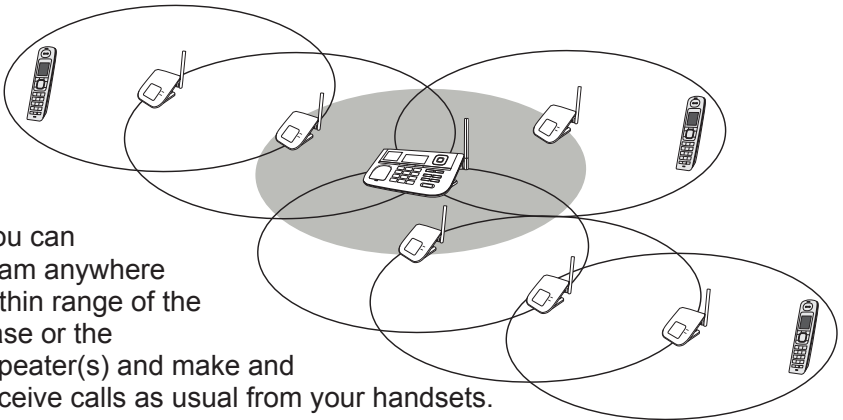

You can roam anywhere within range of the base or the repeater(s) and make and receive calls as usual from your handsets.

- ◆ If you want to use the repeater with a new base, simply register the repeater to the new base (see page 50). The repeater overwrites its own link to the base.

### ***Placing repeaters***

Here are a few tips for placing your repeater so that you get the clearest signal and the maximum range:

- ◆ Make sure you have good reception from the base
- ◆ For best performance put the repeater at least 10m away from the base or any other repeater. (If you install the repeater on a different floor from the base, don't forget to allow 10m vertically, also).
- ◆ If possible, mount the repeater on the wall.

## ***Picking the best spot***

The best spot for the repeater is as far from the base as possible while still maintaining a good signal, or near the edge of the base's coverage area. To find the edge of the coverage area:

1. Stand near the base and make a call on the handset.
2. While on the call, carry the handset away from the base towards the general area where you want to put the repeater.
3. Watch the signal strength icon on the handset. Make a note where the icon drops from 4 bars to 3 bars.
4. Continue walking away from the base.

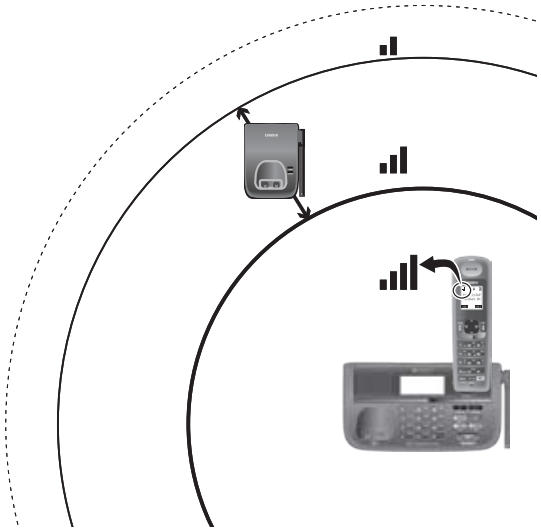

4. Continue walking away from the base. Make a note where the signal strength icon drops from 3 bars to 2 or if you start to hear noise on the line (which indicates the signal is getting weaker).
5. Place the repeater anywhere inside the range where the signal strength icon showed 3 bars and the handset had a clear signal with no noise.

## ***Testing the location***

Connect the repeater's AC adapter and make sure the **LINK** light comes on and steady. If the light flashes, the repeater is not getting a good signal. The repeater may be too far away from the base, there may be interference from electronic devices, or the signal might be blocked by thick walls or metal objects. Try moving the repeater to another location.

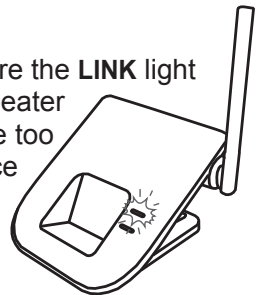

# Getting to Know Your Phone

## Parts of the Base

If the key name is spelled out on the key itself, it's not labeled in the drawing below.

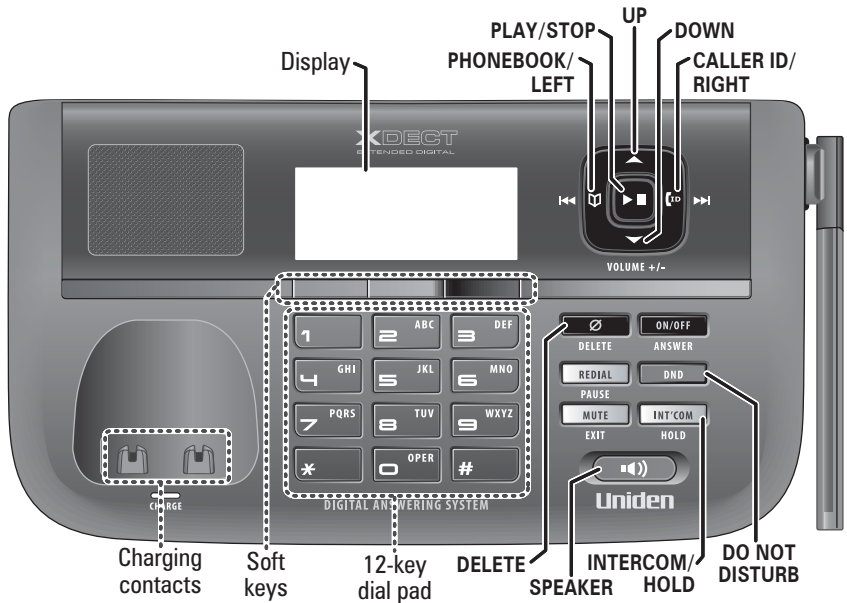

## Base keys and how they work

Key name (and icon)	What it does
PHONEBOOK/ LEFT (📖/⏪)	<ul style="list-style-type: none"> <li>- In standby or during a call: open the phonebook.</li> <li>- During text entry: move the cursor to the left.</li> <li>- In the first 2 seconds of a message: go to the previous message.</li> <li>- Anytime after that: go to the beginning of this message.</li> </ul>
PLAY/STOP (▶/■)	<ul style="list-style-type: none"> <li>- In standby: start playing messages.</li> <li>- While a message is playing: stop playing messages.</li> </ul>

Key name (and icon)	What it does
UP (▲)	<ul style="list-style-type: none"> <li>- In standby: increase the ringer volume for line 1 or line 2.</li> <li>- During a speakerphone call or while a message is playing: increase the speaker volume.</li> <li>- In the menu or any list: move the cursor up one line.</li> </ul>
CALLER ID/ RIGHT ([ID/▶▶])	<ul style="list-style-type: none"> <li>- In standby or during a call: open the Caller ID list.</li> <li>- During text entry: move the cursor to the right.</li> <li>- While a message is playing: skip to the next message.</li> </ul>
DOWN (▼)	<ul style="list-style-type: none"> <li>- In standby: decrease the ringer volume for line 1 or line 2.</li> <li>- During a speakerphone call or while a message is playing: decrease the speaker volume.</li> <li>- In the menu or any list: move the cursor down one line.</li> </ul>
ON/OFF	<ul style="list-style-type: none"> <li>- In standby: turn the answering system on or off.</li> </ul>
DO NOT DISTURB (X)	<ul style="list-style-type: none"> <li>- In standby: turn the Do Not Disturb feature on or off (see page 36).</li> </ul>
INTERCOM/ HOLD	<ul style="list-style-type: none"> <li>- In standby: page a handset using the intercom.</li> <li>- During a call: put the call on hold and start a call transfer.</li> </ul>
SPEAKER (☞))	<ul style="list-style-type: none"> <li>- In standby: start a speakerphone call (get a dial tone).</li> <li>- During a speakerphone call: hang up.</li> </ul>
MUTE/EXIT	<ul style="list-style-type: none"> <li>- While this station is ringing: mute the ringer for this call only.</li> <li>- During a call: mute the microphone.</li> <li>- In the menu or any list: exit the menu completely.</li> </ul>
REDIAL/ PAUSE	<ul style="list-style-type: none"> <li>- In standby: open the redial list.</li> <li>- While entering a phone number: insert a 2-second pause.</li> </ul>
DELETE (Ø)	<ul style="list-style-type: none"> <li>- While a message is playing: delete this message.</li> <li>- In standby: delete all messages.</li> <li>- While entering text: delete one character, or press and hold to delete all the characters.</li> </ul>
<b>SOFT KEYS</b>	<ul style="list-style-type: none"> <li>- The soft keys automatically change their function based on what you are doing. See "Using the Soft Keys" on page 17.</li> </ul>



## Parts of the Handset

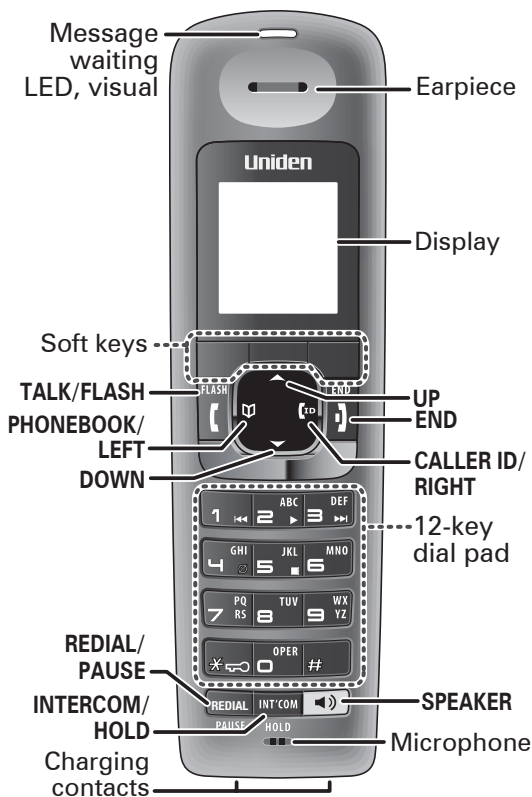

### Handset keys and how they work

Key name (and icon)	What it does
UP (▲)	<ul style="list-style-type: none"> <li>- In standby: increase the ringer volume for line 1 or line 2.</li> <li>- During a call: increase the call volume.</li> <li>- In the menu or any list: move the cursor up one line.</li> </ul>
END	<ul style="list-style-type: none"> <li>- During a call: hang up.</li> <li>- In the menu or any list: exit and go to standby.</li> </ul>

Key name (and icon)	What it does
CALLER ID/ RIGHT (☎️)	<ul style="list-style-type: none"> <li>- In standby or during a call: open the Caller ID list.</li> <li>- During text entry: move the cursor to the right.</li> </ul>
SPEAKER (🔊)	<ul style="list-style-type: none"> <li>- Switch a normal call to the speakerphone (and back).</li> </ul>
INTERCOM/ HOLD	<ul style="list-style-type: none"> <li>- In standby: page another station using the intercom.</li> <li>- During a call: put the call on hold and start a call transfer.</li> </ul>
REDIAL/ PAUSE	<ul style="list-style-type: none"> <li>- In standby: open the redial list.</li> <li>- While entering a phone number: insert a 2-second pause.</li> </ul>
*/ LOCK (🔒)	<ul style="list-style-type: none"> <li>- In standby: press and hold to lock or unlock the keypad.</li> </ul>
DOWN (▼)	<ul style="list-style-type: none"> <li>- In standby: decrease the ringer volume for line 1 or line 2.</li> <li>- During a call: decrease the call volume.</li> <li>- In the menu or any list: move the cursor down one line.</li> </ul>
PHONEBOOK/ LEFT (📖)	<ul style="list-style-type: none"> <li>- In standby or during a call: open the phonebook.</li> <li>- During text entry: move the cursor to the left.</li> </ul>
TALK/FLASH	<ul style="list-style-type: none"> <li>- In standby: start a telephone call (get a dial tone).</li> <li>- During a call: switch to a waiting call.</li> </ul>
<b>SOFT KEYS</b>	<ul style="list-style-type: none"> <li>- The soft keys automatically change their function based on what you are doing. See "Using the Soft Keys" on page 17.</li> </ul>

# Reading the Displays



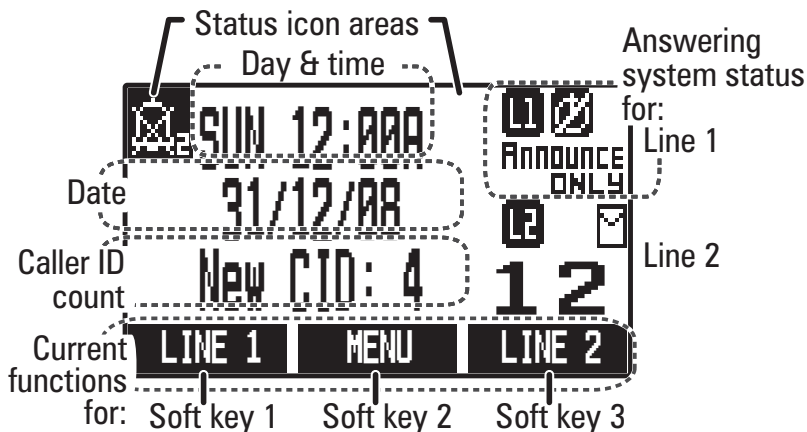

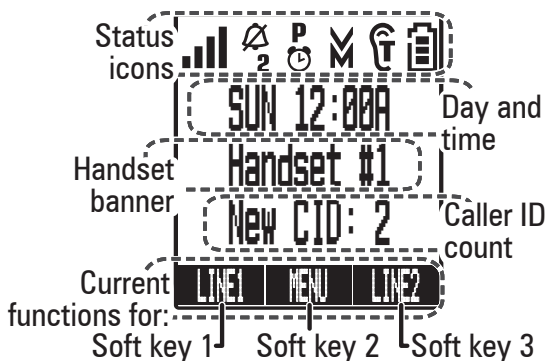

## On the base

















## On the handset



The table below shows the possible icons and what they mean. Since the icons appear based on what you're doing with the phone, you won't ever see all of these icons at the same time.

Base Icon	Handset Icon	What it means
 or 		The accompanying information (in use, on hold, etc.) applies to line 1.
 or 		The accompanying information (in use, on hold, etc.) applies to line 2.

Base Icon	Handset Icon	What it means
		The ringer is turned off for 1) line 1 only, 2) line 2 only, or 3) both. This station will not ring when a call comes in on the indicated lines.
		You have a voice message waiting (see "Using Voice Message Notification" on page 39).
		Privacy Mode is on: no other station can join your call.
		The speakerphone is on.
		The microphone is muted, and the caller can't hear you.
NA		The alarm is set. (See "Using the Alarm Feature" on page 38.)
NA		T-coil mode is on. (See "Do you use a T-coil hearing aid?" on page 48.)
NA		The battery is 1) fully charged, 2) half charged, 3) getting low, or 4) empty.
NA		The signal from the base is 1) very weak, 2) low, 3) strong, or 4) very strong.

### Answering system status icons

The icons on the right hand side of the base display indicate the status of the answering system. Each icon will appear separately for line 1 (at the top) and line 2 (at the bottom). See *Using Your Answering System* on page 40 for more information.

Icon	What it means
	The answering system is off: it will not answer the phone.
<b>ANNOUNCE ONLY</b>	The answering system is set to announce only: it will answer the phone but will not record any messages.
<b>FULL</b>	The answering system memory is full: you must delete some saved messages.
1 through 59	This number indicates the number of new messages for each line.

## Using the Soft Keys

Soft keys are controlled by the software: they will automatically change their function depending on what you're currently doing:

### Soft keys with the phone in standby

On the base

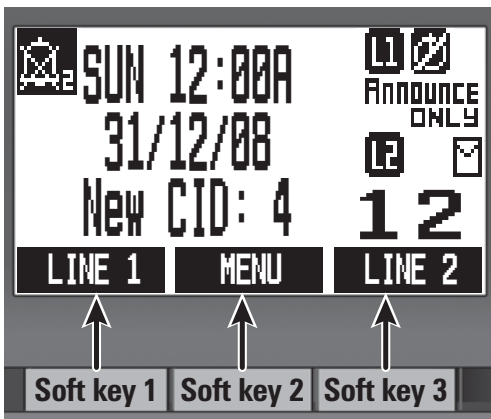

On the handset

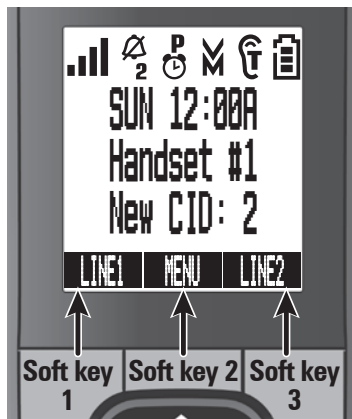

### Soft keys in the main menu

On the base

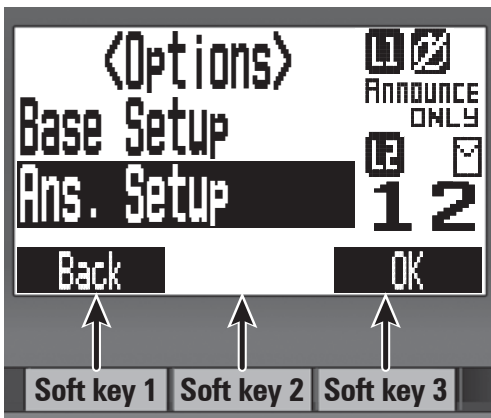

On the handset

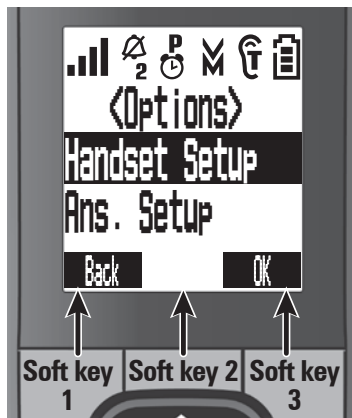

- ◆ The description of the soft key's current function appears in the bottom of the display directly above the corresponding key.

- ◆ If the description for a soft key is blank, that key doesn't currently have a function.
- ◆ Sometimes, the current function of a soft key can duplicate the function of a regular key. If this happens, you can press either key.
- ◆ When this manual refers to a soft key, it uses the soft key's description printed on a black background.

### ***Common soft key descriptions***

The table below lists some soft key descriptions that the phone uses across several menus or operations. These are not all the soft key descriptions, but these are probably the ones you'll see most often.

<b>Soft key description:</b>	<b>What it does:</b>
<b>BACK</b>	Go back to the previous screen. Any unsaved changes on the current screen will be canceled.
<b>CANCEL</b>	Cancel the current operation without saving any changes.
<b>DELETE</b>	Erase the highlighted item.
<b>LINE1</b>	Use line 1 for the current operation.
<b>LINE2</b>	Use line 2 for the current operation.
<b>MENU</b>	Open the main menu screen.
<b>MUTE</b>	Turn off the ringer, speaker, or microphone.
<b>OK</b>	Select the highlighted option or confirm the current operation.
<b>OPTIONS</b>	Show available choices for the current operation or for the highlighted item.
<b>SELECT</b>	Choose the highlighted option.

## Entering Text on Your Phone

When you want to enter text into your phone (for example, a name in the phonebook), use the twelve-key dial pad to enter the letters printed on the number keys. Here's how it works:

- ◆ The phone enters the letters in the order they appear on the key. For example, if you press the number key 2 once, the phone enters the letter *A*. Press 2 twice for *B*, and three times for *C*.
- ◆ If you press the key again after the last letter, the phone starts the same letter sequence with small letters. If you press 2 four times in a row, the phone enters *a* (small letter). Press 2 five times for *b*, and six times for *c*.
- ◆ If you see the icon *[Aa]* in the display, the phone enters capital letters first (*A B C*), then small letters (*a b c*), then the number on the key (*2*). The icon *[aA]* means the phone starts at the small letters, so it enters small letters first, then the number on the key, then capital letters.
- ◆ The phone automatically uses a capital letter for the first letter and any letter right after a space; all other times, it uses small letters.
- ◆ If two letters in a row use the same number key, enter the first letter, then use **CALLER ID/RIGHT** to move the cursor to the next position to enter the second letter.

Switch between capital and small letters	Press <b>*</b> .
Move the cursor	Press <b>PHONEBOOK/LEFT</b> to move the cursor to the left or <b>CALLER ID/RIGHT</b> to move the cursor to the right.
Leave a blank space	Press <b># (POUND)</b> .
Erase one letter	Move the cursor to the letter you want to erase and press the <b>DELETE</b> soft key. (On the base, you can also press <b>DELETE</b> .)
Erase the entire entry	Press and hold <b>DELETE</b> .
Enter punctuation or a symbol	Press <b>0</b> to rotate through the available symbols.

## Using the Menus

The menus are designed to be as easy as possible. Some users don't even need the manual once they know how to perform these actions:

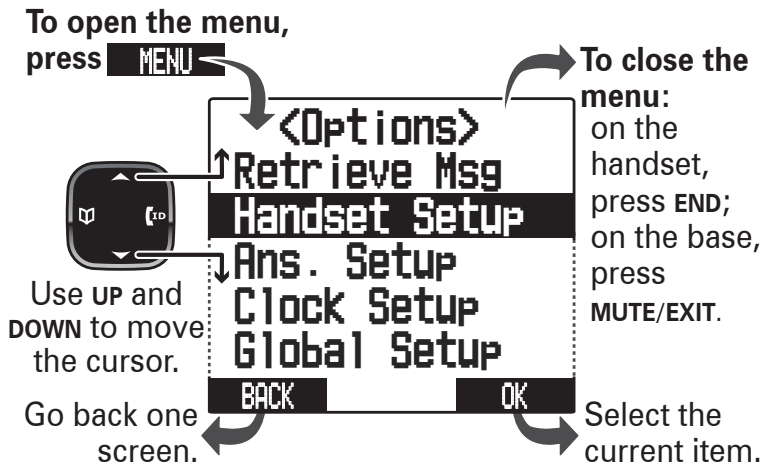

If you don't press any keys for thirty seconds, the phone times out and exits the menu. (When setting the day and time, the time-out period is extended to two minutes.)

Open the menu	Press <b>MENU</b> .
Move the cursor	<p>The cursor (the black bar with the white text) shows which menu item is currently highlighted; when you're entering characters, the cursor shows where you are in the line.</p> <ul style="list-style-type: none"> <li>- Use <b>UP</b> to move the cursor up one line.</li> <li>- Use <b>DOWN</b> to move it down one line.</li> <li>- Use <b>PHONEBOOK/LEFT</b> to move it one space to the left.</li> <li>- Use <b>CALLER ID/RIGHT</b> to move it one space to the right.</li> </ul>
Select an option	Move the cursor to highlight the option, then press <b>OK</b> .
Return to the previous screen	Press <b>BACK</b> . If you press <b>BACK</b> on the first screen, the phone exits the menu.



Close the menu	On the handset, press <b>END</b> ; on the base, press <b>MUTE/EXIT</b> . (If you open the menu during a call, press <b>BACK</b> to back out of the menu without hanging up.)
----------------	---

The next several pages list all the available menu options and how to use them. Most of the menus are the same for the base and cordless handsets; any option that is available only for the base or handset is noted in the description.

## The Handset and Base Setup Menu

When you open the menu on a handset, this menu is called *Handset Setup*. On the base, this menu is called *Base Setup*. Each of these options can be set separately for each station. (A station can be any cordless handset or the base.)

Menu option:	Use it to:
<i>T-coil</i>	(Handset only) Turn on T-coil mode to reduce noise on some hearing aids (see "Do you use a T-coil hearing aid?" on page 48).
<i>Alarm Setting</i>	(Handset only) Set alarms on your handset (see "Using the Alarm Feature" on page 38).
<i>Primary Line</i>	Select the line you want this station to use as the default line when you make a call (see "Assigning a primary line" on page 20). Do not change this setting if you are using only one line.
<i>Ringer Tones</i>	(Handset only) See the ring tones the handset is using as the main ring tone for each line. To change the tone, select the line, then choose a ring tone from the list. (As you highlight each ring tone, the phone plays a sample of the tone. When you hear the tone you want, press <b>OK</b> .)
<i>Personal Ring</i>	(Handset only) Turn on the personal ring feature. If you have Caller ID, this feature lets you assign special ring tones to anyone in your phonebook: this handset will use the special ring tone when that person calls.

<b>Menu option:</b>	<b>Use it to:</b>
<i>Autotalk</i>	(Handset only) Turn on Auto Talk so you can answer the phone just by picking up the handset from the cradle (without having to press any buttons).
<i>Any Key Answer</i>	(Handset only) Turn on Any Key Answer so you can answer the phone by pressing a key on the twelve-key dial pad.
<i>Banner</i>	(Handset only) Change the name used on the handset's display. Enter any name up to 10 characters.
<i>LCD Contrast</i>	Change the contrast of the display.
<i>Key Touch Tone</i>	Have the keypad sound a tone when you press a key.

## The Clock Setup Menu

You must set the date and time if you want to use the handset's alarm feature; setting the clock will also ensure the answering system stamps your messages with the correct time and day. You can set the clock from the base or any cordless handset.

1. Open the menu and select *Clock Setup*.
2. Use the numbers on the twelve-key dial pad to enter the date.
3. Move the cursor to the next line, then use the dial pad to enter the time.
4. Press \* to switch between *AM* and *PM*; when you're finished, press **SAVE**.

## The Global Setup Menu

The settings on this menu are separate for each line: changing the settings for line 1 will not affect line 2, and vice versa. However, the settings for each line apply to all stations whenever they use that line.

Before changing these settings, make sure the phone is in standby and all handsets are within range of the base. (Only one station at a time can change these settings.)

When you select the *Global Setup* menu, the phone prompts you to select *Line 1* or *Line 2*. Then, you can choose one of the following options to change the global settings for that line:

<b>Menu option:</b>	<b>Use it to:</b>
<i>Set Line Mode</i>	Do not change this setting unless instructed to by customer service.
<i>VMWI Reset (Base only)</i>	Reset the voice message waiting indicator to bring it back into sync with your voice mail service (see "Using Voice Message Notification" on page 34).
<i>Insert 0</i>	This feature adds "0" or "00" at the beginning of the number received from Caller ID. The default setting for New Zealand is ON. The default setting for Australia is OFF.

## Special Feature Menus

The following menus control specific features of your phone. These menus are explained under the section that describes the feature in detail:

<b>Menu:</b>	<b>Use it to:</b>	<b>For details, see:</b>
<i>Retrieve Msg</i> (handset only)	Access your answering system from a cordless handset	"Getting Your Messages" on page 42
<i>Ans. Setup</i>	Change the settings for the answering system on each line.	" <i>Ans. Setup</i> menu options" on page 41
<i>Call Blocking</i>	View and edit the Call block list	"Using Call Block" on page 36
<i>Register Handset</i> (base only)	Add new handsets or reset a handset that isn't working properly.	"Resetting and registering handsets" on page 49

# Using Your Phone

## Working with Two Lines

When performing common tasks, you can let the station use the primary line, or you can manually choose a particular line for each task. Using the primary line makes common tasks much simpler, but you will need to assign a primary line to each station (see below).

If you want to...	From a handset	From a handset speakerphone	From the base speakerphone
<b>make a call:</b> Dial the number, then			
- with the primary line	Press <b>TALK/FLASH</b> .	Press <b>SPEAKER</b> .	
- by choosing a line	Press <b>LINE1</b> or <b>LINE2</b> .*		
<b>answer a call</b>			
When a call comes in, the soft keys blink to tell you which line is ringing.			
- with the primary line	Press <b>TALK/FLASH</b> .	Press <b>SPEAKER</b> .	
- by choosing a line	Press the soft key for the line you want to answer.*		
<b>hang up</b>	Press <b>END</b> or return the handset to the cradle.		Press <b>SPEAKER</b> .
<b>switch between the speaker and earpiece</b>	Press <b>SPEAKER</b> .		Not available
<b>put a call on hold</b>	Press <b>INTERCOM/HOLD</b> ; the soft key blinks to remind you the line is on hold. To return to the call, press the soft key ( <b>LINE1</b> or <b>LINE2</b> ) for the holding line.		
<b>switch lines during a call (automatic hold)</b>	Press the soft key for the other line; the current call is automatically put on hold (see above). To return to the call, press the soft key for the holding line.		
<b>mute the microphone during a call</b>	Press <b>MUTE</b> . Press again to turn the microphone back on.		Press <b>MUTE/EXIT</b> .
<b>mute the ringer for this call only</b>	While the phone is ringing, press <b>END</b> .		press <b>MUTE/EXIT</b> .

\* On the handset, press **SPEAKER** to switch to the speakerphone.

## Assigning a primary line (Two Line Only)

You can assign a primary line to each station; the station connects to its primary line whenever it goes off hook (that is, when you press **TALK/FLASH** or **SPEAKER**). Whenever you want, you can bypass the

primary line assignment by manually choosing line for your current task.

To assign a primary line, open the menu and select *Handset Setup* or *Base Setup*. Select *Primary Line*, then choose the line you want this station to connect to when it goes off hook:

<i>Line 1</i>	Always connect to line 1, regardless of either line's status.
<i>Line 2</i>	Always connect to line 2, regardless of either line's status.
<i>Auto</i> (default setting)	Connect to line 1 <b>except</b> under the following circumstances: - there is an incoming call on line 2 - there is a holding call on line 2 - the answering system has picked up line 2 - line 1 is being used for an active call or for screening a call If any one of these conditions is true, the station connects to line 2.

### ***Conferencing two lines together***

When you have active calls on both lines, you can join the two lines together in a conference call.

1. Place the first call on hold.
  2. Switch to the other line and start the second call.
  3. Press **MENU**, then select *Conference*.
- ◆ During a conference call, you can speak with both outside callers at the same time, and the callers can speak with each other.
  - ◆ To separate the conference call back into two independent calls, press the soft key for either line. The other line is automatically put on hold, and you can switch between calls normally.
  - ◆ To disconnect both callers at the same time, just hang up normally.
  - ◆ To disconnect one caller at a time, select the line you want to disconnect, then hang up. Press the soft key to return to the other caller (on hold).

Other stations can also join in the conference call. See ***Using Multi-station Features*** on page 33 for more information.

## Changing the Volume

You can set the volume of the ringer and speaker separately for the base and each handset; you can also set the earpiece volume on each handset. The available volume levels and how to change them are listed below; for each item, press **UP** to make it louder or **DOWN** to make it softer.

Change the	When	On the base	On a handset
ringer volume	the phone is in standby	Press <b>UP</b> or <b>DOWN</b> , select line 1 (single line), then select <i>Off, Low, Medium, or High</i>	
earpiece volume	you are on a normal call	Not available	choose one of 6 volume levels for the active line
speaker volume	you use the speaker-phone for a call or getting messages	choose one of 10 volume levels for the active line	choose one of 6 volume levels for the active line

## Using the Caller ID and Redial Lists

You have to subscribe to Caller ID to use Caller ID features: contact your telephone provider for more information.

Caller ID list information	Redial list information
<ul style="list-style-type: none"><li>- When a call comes in, the phone displays the caller's number and name (if available) along with which line is receiving the call.</li><li>- The phone saves the information for the last 50 calls received on either line to the CID list. The phone records which line the call came in on.</li><li>- When it's in standby, each station displays the total number of calls received on both lines since the last time you checked the CID list.</li><li>- You can edit the list separately on each station.</li></ul>	<ul style="list-style-type: none"><li>- Each station has its own redial list.</li><li>- The redial list contains the last 10 phone numbers dialed from that station.</li><li>- The redial list does not record which line was used to dial the number.</li></ul>

## Using the lists

Open the CID list	Press <b>CALLER ID/RIGHT</b> .
Open the redial list	Press <b>REDIAL/PAUSE</b> .
Scroll through the CID or redial list	Press <b>DOWN</b> to scroll through the list from newest to oldest. Press <b>UP</b> to scroll from oldest to newest.
Close the CID or redial list	Press <b>END</b> on a handset or <b>MUTE/EXIT</b> on the base. (If you open the CID list during a call, press <b>BACK</b> to back out of the list without hanging up.)

## Dialing from the CID or redial list

1. Find the entry you want to dial.
2. To dial the entry with the primary line for this station, press **TALK/FLASH** or **SPEAKER**; to manually choose a line, press **LINE1/LINE2** to dial the entry.

You can also go off hook before you open the list. Press **TALK/FLASH** or **SPEAKER** (for the primary line) or press **LINE1/LINE2**. Find the entry you want, then press **DIAL**.

## Caller ID and redial menu options

Open the CID or the redial list. Find the entry you want and press **OPTIONS**. Choose one of the following:

<i>Store into PB</i>	Add the selected CID/redial list entry to this station's phonebook. The phone creates a new phonebook entry, then prompts you to edit the name and phone number; cordless handsets also prompt you to choose a personal ring (see page 30).
<i>Store &amp; Edit</i>	Append the selected phone number to an existing phonebook entry. The phone prompts you to select the phonebook entry you want to add the number to, then opens that entry for editing (see page 31).
<i>Delete Entry</i>	Erase this entry from the CID or redial list.

<i>Delete All</i>	Erase all entries from this station's CID or redial list. (This doesn't affect the CID or redial lists on any other stations.)
<i>Add Call Block</i>	(CID list only) Add the number to the call block list (see page 36).

## Using Call Waiting

- ◆ A Call Waiting call refers to a call received on a line while that line is already in use.
- ◆ Call Waiting and Caller ID on Call Waiting are services provided by your telephone company. You must subscribe to these services to use these features.
- ◆ Call Waiting is independent for each line: Call Waiting calls do not roll over to the second line.
- ◆ When you get a Call Waiting call, the phone sounds a tone and displays any CID information received for the waiting call.

For Australian Model:

- ◆ Press **TALK/FLASH** on the handset (or **FLASH** on the base) and then press **2** to accept the waiting call. The first caller is put on hold, and you will hear the new caller after a short pause. To return to the original caller, press **TALK/FLASH** (**FLASH** on the base) and then **2** again.

For New Zealand Model:

- ◆ Press **TALK/FLASH** on the handset (or **FLASH** on the base) to accept the waiting call. The first caller is put on hold, and you will hear the new caller after a short pause. To return to the original caller, press **TALK/FLASH** (**FLASH** on the base) again.

## Finding a Lost Handset

With the phone in standby, press **INTERCOM/HOLD** on the base. Select the handset you want to find, or select *All* to page all handsets at the same time. The paged handset(s) will beep for 1 minute or until you



press **INTERCOM/HOLD** again or press **TALK/FLASH** followed by **END** on the handset.

## Using the Headset

You can use a standard 2.5 mm telephone headset with your cordless handsets. To purchase additional headsets (HS910), visit our website; [www.uniden.com.au](http://www.uniden.com.au) for Australian model or [www.uniden.co.nz](http://www.uniden.co.nz) for New Zealand model.

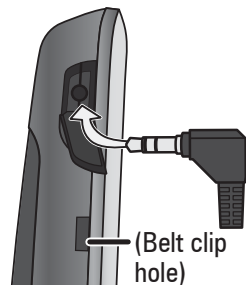

- ◆ To install a headset, remove the headset jack cover and insert the headset plug into the jack.
- ◆ Just make and receive calls as usual, and use your headset to talk to the caller after the call connects.
- ◆ When you connect a headset, the handset automatically mutes the earpiece and speaker. To re-activate the earpiece or speaker, just unplug the headset.

# Using the Phonebook

Each station can store up to 100 entries in its phonebook, and each entry can have two different phone numbers.

Open the phonebook	Press <b>PHONEBOOK/LEFT</b> .
Scroll through the entries	Press <b>DOWN</b> to scroll through the phonebook from A to Z or <b>UP</b> to scroll from Z to A.
Jump to entries that start with a certain letter	Press the number key corresponding to the letter you want to jump to.
Quick dial the primary number for an entry	<ol style="list-style-type: none"><li>1. Find the entry you want to dial.</li><li>2. Press <b>TALK/FLASH</b> or <b>SPEAKER</b>. The phone dials with the primary line for this station.</li></ol>
Dial either number for an entry	<ol style="list-style-type: none"><li>1. Find the entry you want to dial and press <b>SELECT</b>.</li><li>2. Select one of the two phone numbers for that entry.</li><li>3. To dial the number with the primary line for this station, press <b>TALK/FLASH</b> or <b>SPEAKER</b>; to manually choose a line, press <b>LINE1/LINE2</b>.</li></ol>
Use a speed dial number to open a phonebook entry	On the dial pad, press and hold the number assigned to the phonebook entry you want. The phone opens the phonebook and goes directly to that entry. Follow the instructions for dialing an entry above.
Close the phonebook	On the handset, press <b>END</b> ; on the base, press <b>MUTE/EXIT</b> . (If you open the phonebook during a call, press <b>BACK</b> to back out without hanging up.)

## Setting Up Your Phonebook

### *Creating a new entry*

Open the phonebook with the phone in standby, and press **NEW**. The phone walks you through the phonebook entry items in the order listed below. On each screen, press **OK** when you're finished editing the item or if you want to skip the item:

<i>Edit Name</i>	Enter the name (up to 16 characters) you want to use for this entry.
------------------	--

<i>Edit Number1</i>	<p>Enter the primary number (up to 32 digits) for this entry exactly the way you would dial it.</p> <ul style="list-style-type: none"> <li>- If you need the phone to wait before sending the next set of digits, press <b>REDIAL/PAUSE</b> to enter a two-second pause.</li> <li>- If two seconds isn't long enough, you can enter as many pauses as you want.</li> <li>- Each pause counts as one digit (you'll see a P in the number).</li> </ul>
<i>Edit Number2</i>	Enter the secondary number for this entry just like you did the primary number.
<i>Personal Ring selection</i>	(Handset only) Choose the ring tone you want the handset to use when this person calls. As you highlight each ring tone, the handset sounds a sample of that tone.
<i>Speed Dial</i>	<p>Select the speed dial number (<i>SPD0</i> through <i>SPD9</i>) you want to assign to this entry.</p> <ul style="list-style-type: none"> <li>- The speed dial numbers correspond to the numbers (0 through 9) on the twelve key dial pad.</li> <li>- Each speed dial number can be assigned to only one entry.</li> <li>- If the speed dial number is already assigned, the phone shows the name of the entry assigned to the number. If you want to change it, select the number, and the phone overwrites the existing assignment.</li> </ul>

### ***Editing an existing entry***

1. With the station in standby, open the phonebook and find the entry you want.

2. Press **OPTIONS**, then choose *Edit*.

3. Highlight the individual item you want to change and press **SELECT**. The phone goes to the edit screen for that item.

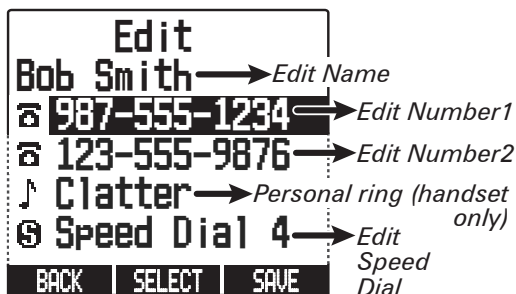

4. Edit the item as described under "Creating a new entry" (above), and press **OK**. OR press **BACK** to cancel editing and return to the main entry.

5. Highlight the next item you want to edit and press **SELECT**. If you're finished editing this entry, press **SAVE**.

## Phonebook Menu Options

Open the phonebook with the phone in standby, and press **OPTIONS** to open the phonebook menu. From the main phonebook screen, you have three options:

<i>Create New</i>	Add an entry to your phonebook. (See "Creating a new entry" on page 30.)
<i>Copy All</i>	Copy the whole phonebook to another station. (You must have at least one cordless handset to use this multi-station feature.)
<i>Delete All</i>	Erase all the entries in this station's phonebook. (This does not affect the entries saved on any other stations.)

If you select an individual entry and then press **OPTIONS**, you have these additional options:

<i>Copy</i>	Copy this entry to another station. (You must have at least one cordless handset to use this multi-station feature.)
<i>Edit</i>	Edit this entry. (See "Editing an existing entry" on page 31.)
<i>Delete</i>	Erase this entry.

## Chain Dialing

- ◆ If you often have to enter a series of digits or a code number during a call, you can save that code number to a phonebook entry and use the phonebook to send the code number.
- ◆ Enter the code number (up to 32 digits) into the phonebook just like a regular phonebook entry. Be sure to enter the code number into the phonebook exactly as you would enter it during a call.

During your call, when you hear the prompt to enter the code number:

1. Open the phonebook and find the entry that contains your code number.
2. Press **SELECT** and select the number (phone number 1 or 2) you want.
3. Press **DIAL** to transmit the code. The phone transmits the code number exactly as you entered it in the phonebook.  
OR if you change your mind, use **BACK** to close the phonebook.

# Using Multi-station Features

The expandable base works together with the accessory handsets to give you some useful multi-station features. (A station can be any cordless handset or the base.) You must have at least one accessory handset to use the features in this section.

## Expanding Your Phone

- ◆ Your base supports a total of six XDECT R005 accessory handsets, including any that were supplied with your phone.
- ◆ Your base might be compatible with other Uniden accessory handsets: please visit our website for a list of compatible handsets.
- ◆ Accessory handsets must be registered to the base before you can use them. Handsets that aren't registered display a *Handset not registered* message. For instructions on registering handsets to this base, see page 49 or refer to the manual that came with the accessory handset.
- ◆ Any accessory handsets that came packaged with the base are already registered to that base for you.
- ◆ If a handset was previously registered to a base, you have to reset it so you can register it to a new base (see page 49 for XDECT R005 handsets).

## Using Multi-Station Conference Calling

- ◆ When an outside call comes in on either line, the base and four cordless handsets can join in a six-way conference call with the outside caller.
- ◆ To join a call in progress, just connect to the active line (press **LINE1** or **LINE2**).



- ◆ To leave a conference call, hang up normally; all other stations remains connected to the call.
- ◆ If you conference line 1 and line 2 together (see page 23), the base and four cordless handsets can hold a seven-way call with both outside callers at the same time.
- ◆ You can also use the speakerphone for a conference call, just like you can with a normal call.

## Using Privacy Mode

You can prevent other stations from joining a call. Start your call as usual, then press **MENU** and select *Call Privacy*. When you hang up, privacy mode turns off automatically.

As long you have privacy mode on, no other stations can interrupt your call (you'll see a **P** in the handset display and a **P** in the base display). To allow another station to join the call, just turn privacy mode off by repeating the process above (press **MENU** and select *Call Privacy*).

## Using Call Transfer

To...	From the base	From a handset
transfer a call	1. Press <b>INTERCOM/HOLD</b> to put the call on hold. 2. Select the station you want to transfer the call to, or select <i>All</i> to page all the stations at the same time. When the other station accepts the call, you'll be disconnected, but you can join the call again.	
cancel a transfer	Press <b>SPEAKER</b> to return to the call.	Press <b>TALK/FLASH</b> to return to the call.
accept a transferred call	1. To answer the page and speak to the transferring station, press <b>INTERCOM/HOLD</b> . 2. To accept the call, press the soft key ( <b>LINE1</b> or <b>LINE2</b> ) for the holding line.	

## Using the Intercom

Here are some things you need to know about using the intercom:

- ◆ Whenever the phone is in standby, you can make an intercom call between stations without using the phone line.
- ◆ You can make an intercom call from any station, but only two stations can be in an intercom call at any time.
- ◆ If an outside call comes in during an intercom call, the phone shows the CID information. If the other station hasn't answered the page, the phone cancels the page so you can answer the incoming call.

To...	From the base	From a handset
make an intercom page	1. Press <b>INTERCOM/HOLD</b> . 2. Select the station you want to talk with, or select <i>A//</i> to page all the stations at the same time.	
cancel a page	Press <b>INTERCOM/HOLD</b> .	Press <b>END</b> .
answer an intercom page	Press <b>INTERCOM/HOLD</b> .	Press <b>INTERCOM/HOLD</b> or <b>TALK/FLASH</b> .
leave an intercom call	Press <b>INTERCOM/HOLD</b> .	Press <b>END</b> .
answer an outside call during an intercom call	Press the soft key ( <b>LINE1</b> or <b>LINE2</b> ) for the line you want to answer. The phone automatically disconnects the intercom call and connects you to the outside line.	

---

# Using Special Features

## Using Do Not Disturb

- ◆ The *Do Not Disturb* or *DND* feature turns off the ringers of the base and all handsets at the same time.
- ◆ With the phone in standby, press and hold **DO NOT DISTURB** on the base. The phone automatically turns on the answering system and shows *Do Not Disturb* in the display on all stations.
- ◆ To cancel, press **DO NOT DISTURB** again.

If you turn the answering system off while DND is on, the phone turns off DND along with the answering system.

## Using Call Block

If you subscribe to Caller ID, you can block incoming calls by adding numbers to the call block list.

- ◆ When either line receives a call, the phone compares the received phone number to the numbers on the call block list. If the phone number is on the list, the phone replaces the caller's name with *Call Blocked* and disconnects the call. (The caller hears a reject message.)
- ◆ The call block list holds 20 entries; this list applies to all stations and both lines.
- ◆ You can add a number to the call block list through the CID list options (select *Add Call Block*), or through the *Call Blocking* menu (select *New Entry*).
- ◆ Only one station can edit the call block list at a time.



### **Call Blocking menu options**

With the phone in standby, open the menu and select *Call Blocking*. Choose one of these options:

<i>View Number</i>	See the numbers on your call block list.
<i>Create New</i>	Add an entry to your call block list. The phone will prompt you to enter a name (optional) and phone number.
<i>Private Number</i>	Block all calls from numbers reported by CID as "Private." (This does not count as one of the 20 entries.)
<i>Unknown Number</i>	Block all calls from numbers reported by CID as "Unknown". (This does not count as one of the 20 entries.)

### **Add Caller ID number to Call block list**

With the phone in standby, open the Caller ID list and find the entry you want. Press [OPTIONS] to open the individual entry menu. Choose Add Call Block to copy the number into the Call block list.

### **Call block entry options**

With the phone in standby, open the call block list and find the entry you want. Press **OPTIONS** to open the individual entry menu. Choose one of these options:

<i>Edit</i>	Edit this entry. The phone will prompt you to edit the name and phone number.
<i>Delete Entry</i>	Erase this entry from the list and allow calls from this number.

## Using the Alarm Feature

You can set 3 different alarms on each cordless handset so your phone can remind you of important events. When an alarm is set, the alarm icon (🔔) appears on the top of the screen.

### Setting an alarm

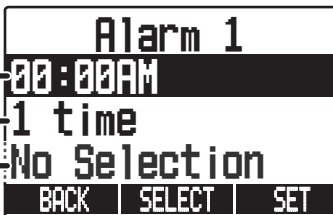
1. Open the menu and select *Handset Setup*.
2. Select *Alarm Setting*, then select the alarm (*Alarm1*, *Alarm2*, or *Alarm3*) you want to set.
3. To turn on the alarm, select *On*. The phone goes to the alarm edit screen.

Time setting — 00:00AM  
Repeat setting — 1 time  
Ringer setting — No Selection
4. Highlight the time setting and press **SELECT**.
5. Use the number keys to set the time you want the alarm to ring; press **OK** when you're finished.
6. Highlight the repeat setting and press **SELECT**. Select how often you want the alarm to ring—once only (*1 time*), every day (*Daily*), or on a weekly basis (*Select Days*)—then press **OK**.
7. If you choose *Select Days*, the handset prompts you to choose which days of the week the alarm should ring. To choose a day, highlight it and press **SELECT**; a check mark appears beside that to show that it is selected. Select as many days as you want, then press **OK**. The alarm will ring on each day with a check mark beside it.

Select Days  
 Monday  
 Tuesday
8. Highlight the ringer setting and press **SELECT**.
9. Select the ring tone you want the alarm to use, then press **OK**.
10. When you are finished setting all the alarm options, press **SET** to activate the alarm. The time and repeat setting will show on the main *Alarm Setting* screen. (If you selected specific days, the repeat setting displays as *Weekly*.)

Alarm Setting  
08:00AM Weekly  
Alarm2

## When an alarm rings

When the day and time on the phone matches the day and time of an alarm setting, the handset sounds the selected tone and displays the alarm screen.



- ◆ The alarm will ring for three minutes. To turn off the alarm, press **END**. When the phone prompts you to confirm, press **YES**.
- ◆ To temporarily turn off the alarm, press **SNOOZE** (or just let the alarm ring for the three minutes). The alarm will ring again in five minutes.
- ◆ To cancel snooze, press **END** the next time the alarm rings. When the phone prompts you to confirm, press **YES**.

## Using Voice Message Notification

This feature supports Frequency-Shift Keying (FSK) message notification. Contact your voice mail provider for more details.

If you subscribe to a voice mail service, your phone can notify you when you have a new message waiting on either line. When you have new messages, the voice message icon (M) appears in the display, and the new message light (at the top of the handset) blinks.

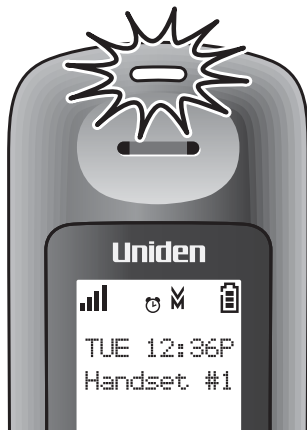

### Resetting the voice message indicator

If the voice message icon remains after you check your messages, you can reset it from the base:

1. Open the menu and select *Global Setup*.
2. When the phone prompts you to select a line, select **Line 1** or **Line 2**,
3. Select *VMWI Reset*, then select *Yes* to reset the indicator.

---

# Using the Answering System

Each line has a separate answering system. Whenever you access the answering system, the phone prompts you to choose a line. After that, any settings or operations will affect only the answering system for that line. For example, deleting all the messages from the answering system from line 1 does not affect any messages on the answering system for line 2.

## Setting Up Your Answering System

### ***Recording your outgoing message***

Your personal outgoing message or greeting can be between 2 seconds and 30 seconds long. If you don't want to record an outgoing message, the system will use its pre-recorded greeting:

*Hello, no one is available to take your call. Please leave a message after the tone.*

To record your greeting:

1. Open the menu and select *Ans. Setup*.
2. Select *Line 1* or *Line 2*, then select *Record Greeting*.
3. Press **START**. Wait for the system to say "Record greeting" and then begin your recording.
4. When you're finished, press **STOP**. The system plays back your new greeting.
5. To keep this greeting, press **OK** again. To delete it and try again, press **DELETE**.

### ***Switch between the pre-recorded greeting and your greeting***

1. Open the menu and select *Ans. Setup*.
2. Select *Line 1* or *Line 2*, then select *Greeting Options*.
3. The system plays back the current greeting (personal or pre-recorded) for this line. Press **CHANGE** to switch greetings or **OK** to keep the current greeting.

## Delete your greeting

1. Open the menu and select *Ans. Setup*.
2. Select *Line 1* or *Line 2*, then select *Greeting Options*.
3. While the system plays back the current greeting, press **DELETE** to erase the personal greeting for this line. (You can't erase the pre-recorded greeting.)

## Ans. Setup menu options

You can change the answering system options separately for each line. When you select the *Ans. Setup* menu, the phone prompts you to select *Line 1* or *Line 2*. Then, you can choose one of the following options to change the answering system settings for that line:





<i>Security Code</i>	Enter a 2-digit PIN so you can access your answering system from any touch-tone phone (see page 44).
<i>Ring Time</i>	Set the number of rings (6, 9, or 12) before the answering system answers the phone. Choose <i>Toll Saver</i> to have the system pick up after 2 rings if you have new messages or after 4 rings if you don't.
<i>Record Time</i>	Set the amount of time callers have to leave a message, either 1 minute or 4 minutes. Choose <i>Announce Only</i> if you don't want the system to let callers to leave a message.
<i>Message Alert</i>	Have the system beep every 15 seconds when you have a new message; the beeping stops when you listen to all your new messages. (To mute the alert without listening to your messages, press any key on the base.)
<i>Call Screen</i>	Turn on the call screen feature so you can hear callers as they leave messages on the base speaker (see page 43).
<i>Ans. On/Off</i>	Turn your answering system on or off. (To turn your system on or off from the base, just press <b>ON/OFF</b> .)
<i>Record Greeting</i>	Record a personal greeting (see page 40).
<i>Greeting Options</i>	Switch between your personal greeting and the pre-recorded greeting or delete your personal greeting (see page 40).

## Getting Your Messages

### *Accessing your system from a handset (remote operation)*

You can access your system from a handset whenever the phone is in standby. Only one handset at a time can access the system through remote operation, and you can't use remote operation if the base is using the answering system.

- ◆ To start remote operation, open the menu and select *Retrieve Msg.* When the phone prompts you to select a line, press **LINE1** or **LINE2**.
- ◆ During remote operation, the handset beeps to let you know it's waiting for your next command. If you don't press any keys for 30 seconds, the phone returns to standby.
- ◆ The icons on the handset's number keys and display show you which number key activates each answering system command; these commands correspond to the answering system keys on the base:

Icon	Command Name	Handset key	Base key
	Play	<b>2</b>	<b>PLAY/STOP</b>
	Stop	<b>5</b>	<b>PLAY/STOP</b>
	Repeat	<b>1</b>	<b>PHONEBOOK/LEFT</b>
	Skip	<b>3</b>	<b>CALLER ID/RIGHT</b>
	Delete	<b>4</b>	<b>DELETE</b>

### *How to operate your answering system*

To...	From the base	From a handset (during remote operation)
play new messages	Press <b>PLAY/STOP</b> then select a line. The system announces the number of new and old messages, then plays the first new message followed by the day and time it was received. Then the system plays the new messages in the order they were received.	Press <b>2</b> .
restart the current message	Press <b>PHONEBOOK/LEFT</b> .	Press <b>1</b> .

To...	From the base	From a handset (during remote operation)
replay previous messages	Press <b>PHONEBOOK/LEFT</b> repeatedly until you hear the message you want to replay.	Press <b>1</b> repeatedly until you hear the message you want to replay.
skip a message	Press <b>CALLER ID/RIGHT</b> .	Press <b>3</b> .
delete a message	While the message is playing, press <b>DELETE</b> .	While the message is playing, press <b>4</b> .
delete all of your messages	With the phone in standby, press <b>DELETE</b> . When the system prompts you to select a line, press <b>LINE1</b> or <b>LINE2</b> .	Not available.
play old messages	After the system plays the new messages, press <b>PLAY/STOP</b> again. When the system prompts you to select a line, press <b>LINE1</b> or <b>LINE2</b> .	press <b>2</b> .
exit the system	Press <b>PLAY/STOP</b> .	Press <b>END</b> .

## Screening Your Calls

Another feature your answering system gives you is *call screening*. While the system is taking a message, you can hear the caller on the base speaker (if you turn on *Call Screen*) or from a handset.

To...	From the base	From a handset
hear the caller leaving a message	Just listen to the caller over the speaker.	Press <b>SCREEN</b> .
answer the call	Press <b>SPEAKER</b> .	Press <b>TALK/FLASH</b> .
mute the call screen without answering	Press <b>MUTE/EXIT</b> .	Press <b>MUTE</b>

- ◆ If you mute the call screen, the system continues taking the message: it just stops playing through the speaker.
- ◆ Up to four handsets at a time can screen calls. If a fifth handset tries to screen the call, the handset sounds an error tone and displays a *System Busy* message.

## Using the System While You're Away from Home

You can also operate your answering system from any touch-tone phone. Before you can use this feature, you have to program a security code.

### **Programming a security code**

1. With the phone in standby, open the menu and select *Ans. Setup*.
2. When the phone prompts you to select a line, select **Line 1** or **Line 2**, then select *Security Code*.
3. Use the number keypad to enter a two-digit security code (00 to 99). Press **OK** when you're finished.

Remember to make a note of your new security code!

### **Dialing in to your system**

1. Call your telephone number and wait for the system to answer. (If your answering system is off, it will answer after about fifteen rings and sound a series of beeps instead of your greeting.)
2. During the greeting (or beeps), press # and immediately enter your security code. (You have 3 tries to enter you security code: if you enter it wrong 3 times, the system hangs up and returns to standby.)
3. The system announces the current time, the number of messages stored in memory, and a help prompt. Then it starts beeping intermittently to let you know it's waiting for your command.
4. When you hear the intermittent beeping, enter a command from the chart to the right.

If you don't press any keys for 15 seconds, the phone will hang up and return to standby.

#-1	Repeat message
#-2	Play message
#-3	Skip message
#-4	Delete message
#-5	Stop playback
#-6	Turn the system on
#-9	Turn the system off
#-0	Hear help prompts



# Solving Problems

If you have any trouble with your phone, try these simple steps first. If you still have a question, call our Customer Care Line listed on the front cover.

If...	Try...
No stations can make or receive calls.	<ul style="list-style-type: none"><li>- Checking the telephone cord connection.</li><li>- Disconnecting the base AC adapter. Wait a few minutes, then reconnect it.</li></ul>
One cordless handset can't make or receive calls.	<ul style="list-style-type: none"><li>- Moving the handset closer to the base.</li><li>- Resetting the handset.</li></ul>
A station can make calls, but it won't ring.	<ul style="list-style-type: none"><li>- Making sure the ringer is turned on.</li><li>- Making sure Do Not Disturb is turned off (see page 36).</li></ul>
I can't make or receive calls on line 2.	<ul style="list-style-type: none"><li>- Making sure line 2 is properly connected (see page 2).</li><li>- Seeing if another station has activated Privacy Mode on line 2.</li><li>- Making sure you have subscribed to 2 separate lines from your phone company.</li></ul>
I can't conference line 1 and line 2 together.	<ul style="list-style-type: none"><li>- Seeing if another station has activated Privacy Mode on one of the lines (see page 34).</li></ul>
A cordless handset's display won't turn on.	<ul style="list-style-type: none"><li>- Charging the battery for 15-20 hours.</li><li>- Checking the battery pack connection.</li></ul>
A cordless handset is not working.	<ul style="list-style-type: none"><li>- Charging the battery for 15-20 hours.</li><li>- Checking the battery pack connection.</li><li>- Resetting the handset.</li></ul>
A cordless handset says <i>Unavailable</i> .	<ul style="list-style-type: none"><li>- Moving the handset closer to the base.</li><li>- Seeing if another station has Privacy Mode on (see page 34).</li><li>- Making sure the base is plugged in.</li></ul>

<b>If...</b>	<b>Try...</b>
No stations will display any Caller ID information.	<ul style="list-style-type: none"> <li>- Letting calls ring at least twice before answering.</li> <li>- Seeing if the call was placed through a switchboard.</li> <li>- Checking with your telephone service provider to make sure your Caller ID service is active.</li> </ul>
Caller ID displays briefly and then clears.	<ul style="list-style-type: none"> <li>- You may have to change the line mode. Contact customer service for more information.</li> </ul>
I can't transfer calls.	<ul style="list-style-type: none"> <li>- Resetting all the handsets (see page 49).</li> </ul>
I can't get two cordless handsets to talk to the caller.	<ul style="list-style-type: none"> <li>- Making sure both handsets are registered to this base.</li> <li>- Making sure no station is in Privacy Mode (see page 30).</li> </ul>
The phone keeps ringing if I answer on an extension.	<ul style="list-style-type: none"> <li>- You may have to change the line mode. Contact customer service for more information.</li> </ul>
I can't save a number to an existing phonebook entry.	<ul style="list-style-type: none"> <li>- Seeing if the number is already in the phonebook.</li> <li>- Seeing if that entry already has two phone numbers.</li> </ul>
The answering system does not work.	<ul style="list-style-type: none"> <li>- Making sure the answering system is turned on.</li> <li>- Making sure the base AC adapter is not plugged into an that's controlled by a wall switch.</li> </ul>
The answering system won't record messages.	<ul style="list-style-type: none"> <li>- Making sure the Record Time is not set to Announce Only (see page 41).</li> <li>- Deleting messages (the memory may be full).</li> </ul>
A handset can't access the answering system.	<ul style="list-style-type: none"> <li>- Making sure no other handset is using the system.</li> <li>- Making sure the phone is in standby.</li> </ul>
My outgoing message is gone.	<ul style="list-style-type: none"> <li>- Seeing if there was a power failure. You may have to re-record your personal outgoing message.</li> </ul>
I can't hear the base speaker.	<ul style="list-style-type: none"> <li>- Making sure call screening is turned on (see page 41).</li> <li>- Changing the base speaker volume.</li> </ul>

If...	Try...
Messages are incomplete.	<ul style="list-style-type: none"> <li>- The incoming messages may be too long. Remind callers to leave a brief message.</li> <li>- Deleting messages (the memory may be full).</li> </ul>
The system keeps recording if I answer on an extension.	<ul style="list-style-type: none"> <li>- You may have to change the line mode. Contact customer service for more information.</li> </ul>
I can't register a handset.	<ul style="list-style-type: none"> <li>- Seeing if there are 10 handsets registered to this base.</li> <li>- Resetting the handset.</li> </ul>
My alarm rings at the wrong time.	<ul style="list-style-type: none"> <li>- Making sure the time is set correctly (see page 22).</li> </ul>
My alarm won't ring on the right day(s).	<ul style="list-style-type: none"> <li>- Making sure the days are selected (see page 38).</li> <li>- Making sure the date is set correctly (see page 22).</li> </ul>

## Weak or Hard To Hear Audio

If a caller's voice sounds weak or soft, the signal might be blocked by large metal objects or walls; you might also be too far from the base, or the handset's battery may be weak.

- ◆ Try moving around while you're on a call or moving closer to the base to see if the sound gets louder.
- ◆ Make sure the handset's battery is fully charged.
- ◆ Try adjusting the earpiece volume.

## Noise or Static On The Line

Interference is the most common cause of noise or static on a cordless phone. Here are some common sources of interference:

- ◆ electrical appliances, especially microwave ovens
- ◆ computer equipment, especially wireless LAN equipment and DSL modems

- ◆ radio-based wireless devices, such as room monitors, wireless controllers, or wireless headphones or speakers
- ◆ large fluorescent light fixtures (especially if they give off a buzzing noise)
- ◆ other services that use your phone line, like alarm systems, intercom systems, or broadband Internet service

### Do you use a T-Coil hearing aid?

If you have a hearing aid equipped with a telecoil (T-coil) feature, the interaction between the hearing aid and digital cordless phones can cause noise in the handset. If you have a T-coil hearing aid and you have problems with noise on the line, try turning on *T-coil* mode. Open the menu; select *Handset Setup*, then select *T-coil*.

**Using T-coil mode can shorten the handset's talk time; make sure to watch the battery status and keep the battery charged.**

### Here are some hints for when the static is...

on 1 handset or in 1 location:	on all handsets or in all locations:
<ul style="list-style-type: none"> <li>- Check nearby for one of the common interference sources.</li> <li>- Try moving the handset away from a suspected source, or try moving the suspected source so it's not between the handset and the base.</li> <li>- Try moving closer to the base. There is always more noise at the edges of the base's range. If the handset displays an Out of Range message, you need to move closer to the base.</li> </ul>	<ul style="list-style-type: none"> <li>- Check near the base for the source of interference.</li> <li>- Try moving the base away from a suspected source, or turn off the source if possible.</li> <li>- If the base has an adjustable antenna, try raising the antenna so it stands straight up.</li> <li>- If you have any service that uses the phone line, you might need a filter (see below).</li> </ul>

### Installing a line filter or DSL filter

Sometimes, broadband Internet services that use the telephone line can interfere with phones. One of these services -DSL- often causes static on telephones. A DSL filter or telephone line filter usually solves this problem. The technician who installed your DSL service might have left some filters for you; if not, call your DSL provider or look in any electronics store.

Plug the DSL filter into the telephone wall jack and plug your phone's base into the filter. Make a test call to make sure the noise is gone.

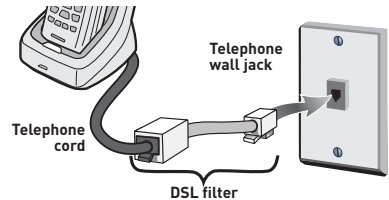

Plug the DSL filter into the telephone wall jack and plug your phone's base into the filter. Make a test call to make sure the noise is gone.

## Resetting and Registering Handsets

If you are having trouble with a cordless handset or if you want to replace one, you need to clear the registration information from the base and the handset:

Do you have the base the handset is registered to?	
Yes	No
<ol style="list-style-type: none"><li>1. Press and hold <b>END</b> and <b>#</b> until the <i>System Reset</i> menu appears (about 5 seconds).</li><li>2. Select <i>Deregister HS</i>. The display lists all registered handsets.</li><li>3. Select the handset you want to reset.</li><li>4. When the handset asks you to confirm, select <i>Yes</i>. (It may ask you twice, just to be sure.) The handset clears its information from the base and deletes its own link to the base.</li></ol>	<ol style="list-style-type: none"><li>1. Press and hold <b>END</b> and <b>#</b> until the <i>System Reset</i> menu appears (about 5 seconds).</li><li>2. Select <i>Base Unavailable</i>.</li><li>3. When the handset asks you to confirm, select <i>Yes</i>. (It may ask you twice, just to be sure.) The handset deletes its own link without contacting the base.</li></ol>

When you reset a handset (or if you buy a new one), that handset displays a *Handset Not Registered* message. If you see this message on a handset, you need to register it to a base before you can use it.

### Registering a handset

Does the handset fit in the base cradle?	
Yes	No
Place the handset in the base. The display should say <i>Handset Registering</i> .	<ol style="list-style-type: none"><li>1. On the base, open the menu and select <i>Register Handset</i>.</li><li>2. On the handset you want to register, press and hold <b>#</b> until the display says <i>Handset Registering</i> (about 2 seconds).</li></ol>

In about 30 seconds, the handset display should say *Registration Complete*. Press **TALK/FLASH** and make sure you get a dial tone.

If...	Try...
<ul style="list-style-type: none"><li>- you don't hear a dial tone</li><li>- the display says Registration Failed</li></ul>	Making sure the handset is fully charged, then start over at step 1.

To register a handset to a different base, see the section "Expanding Your Phone" in the owner's manual for the other base.

## Registering Repeaters

If you are having trouble with a repeater or if you want to replace one, you need to register the repeater to the base.

TIP: Connect the repeater close to the base for easy access to the necessary buttons and indicators. Locate the repeater in the desired position after registration is complete.

1. On the base, open the menu and select *Register Handset*.

2. On the bottom of the repeater you want to register, press and hold the registration button until the **LINK** light blinks rapidly.

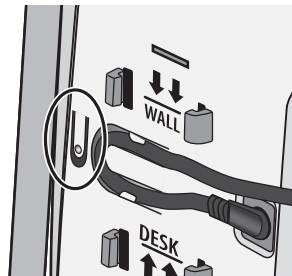

3. In about 90 seconds, the **LINK** light on the repeater will turn on. The repeater has been registered to the base.



If the **LINK** light doesn't turn on, try these steps again.

**- Only register one repeater at a time. If more than one repeater is in registration mode at the same time then they can interfere with each other.**

**- Only register a repeater to one base at a time. If more than one base is in registration mode at the same time then you can't control which base the repeater registers to.**

## Handling Liquid Damage

Moisture and liquid can damage your cordless phone.

- ◆ If the handset or base is exposed to moisture or liquid, but only the exterior plastic housing is affected, wipe off the liquid, and use as normal.
- ◆ If moisture or liquid has entered the plastic housing (i.e. liquid can be heard in the phone or liquid has entered the handset battery compartment or vent openings on the base), follow these steps:

Handset	Base
<ol style="list-style-type: none"><li>1. Remove the battery cover and disconnect the battery.</li><li>2. Let dry for at least 3 days with the battery disconnected and the cover off for ventilation.</li><li>3. After the handset dries, reconnect the battery pack and replace the cover. Recharge the battery fully (15-20 hours) before using.</li></ol>	<ol style="list-style-type: none"><li>1. Disconnect the AC adapter to cut off the power.</li><li>2. Disconnect the telephone cord.</li><li>3. Let dry for at least 3 days before reconnecting.</li></ol>

IMPORTANT: You must unplug the telephone line while recharging the battery pack to avoid charge interruption.

---

***CAUTION! DO NOT use a microwave oven to speed up the drying process. This will cause permanent damage to the handset, base and the microwave oven.***

---

# Important Information

## Terms Used In This Manual

Accessory Handset	An extra handset that can register to and be used with an expandable phone base. All accessory handsets must be registered to a base.
Base	The main part of the phone. It connects to your phone line and lets you make and receive calls. Most bases also have a cradle to store a handset.
CIDCW	(CID on Call Waiting.) A service that shows CID for calls that come in during another call.
Call Waiting	A service that lets you receive calls while you are on another call.
Caller ID	(Also called CID.) A service that shows the name and number of incoming callers.
Charger	A cradle that stores and charges a handset but doesn't connect to the phone line.
Cradle	The part of the phone that stores a handset. While in a cradle, a handset is always in standby, and any keys are locked.
During a call	The station is currently on a call or has activated a dial tone.
Handset	A cordless handset that you use to dial the phone and talk to callers.
In standby	The phone is inactive: there is no dial tone, no station is on a call or listening to messages.
Line 1 and Line 2	Line 1 is connected to <b>PRIMARY LINE</b> , and line 2 is connected to <b>TEL LINE 2</b> . You can switch Line 1 and Line 2 just by swapping the connectors.
Off hook	The phone is connected to an outside line: there is a dial tone or an ongoing call.
Soft key	A software-controlled button that can change its function to fit the current operation.
Station	Any handset or the base.

## Specifications

		Base	Repeater/Charger
AC adapter	Part number	AAD-041S(M)	AAD-041S(M)
	Input voltage	240V AC, 50Hz	240V AC, 50Hz
	Output voltage	9V DC@ 350mA	9V DC@ 350mA
Battery pack	Part number	BT-694 or BT-694s	
	Capacity	650mAh (BT-694) or 500mAh (BT-694s)	

- Use only the supplied AC adapters.
- Be sure to use the proper adapter for the base and any chargers.
- Do not place the power cord where it creates a trip hazard or where it could become chafed and create a fire or electrical hazard.
- Do not place the base in direct sunlight or subject it to high temperatures.



## Battery Information

- ♦ Fully charged, the battery should provide about 8 hours of talk time and about 7 days of standby time. For best results, return the handset to the cradle after each call to keep it fully charged.
- ♦ Keep an eye on the battery status icon. When the battery gets too low, the handset shows a low battery alert. If you hear a strange beep during a call, check the display: if you see the low battery alert, finish your conversation as quickly as possible and return the handset to the cradle. If the handset is in standby, none of the keys will operate.
- ♦ With normal use, the battery should last about one year. Replace the battery when the talk time becomes short even when the battery is charged. To buy a replacement battery, visit the website; [www.uniden.com.au](http://www.uniden.com.au) for Australian model or [www.uniden.co.nz](http://www.uniden.co.nz) for New Zealand model.

### ***Rechargeable Nickel-Metal-Hydride Battery Warning***

---

***CAUTION! Risk of explosion if battery is replaced by an incorrect type! Dispose of used batteries according to the instructions. Do not open or mutilate the battery. Disconnect the battery before shipping this product.***

---

- ♦ This equipment contains a rechargeable Nickel-Metal-Hydride battery.
- ♦ The rechargeable batteries contained in this equipment may explode if disposed of in a fire.
- ♦ Do not short-circuit the battery.
- ♦ Do not charge the rechargeable battery pack used in this equipment with in any charger other than the one designed to charge this battery pack as specified in the owner's manual. Using another charger may damage the battery pack or cause the battery pack to explode.

### **Rechargeable Batteries Must Be Recycled or Disposed of Properly.**

**Uniden works to reduce lead content in PVC coated cords in our products & accessories.**

# Index

## A

Alarm Feature .....	38
Answering a Call .....	24
Answering System .....	40
Any Key Answer .....	22
AutoTalk.....	22

## B

Base Unavailable .....	49
Battery Install .....	5
Battery Specifications .....	52
Battery Information .....	53

## C

Caller ID .....	26
Call Block .....	36
Call Waiting.....	28
Conferencing .....	25, 33
Controls Parts of the Phone.....	11, 13

## D

Date and Time .....	22
Deleting a Redial Record.....	27
Deleting Caller ID Numbers .....	27
Deleting Phonebook Entries .....	32
Deregistration.....	49
Do Not Disturb .....	36

## E

Earpiece Volume.....	26
Entering Text from the Phone.....	19

## F

Finding a handset .....	28
-------------------------	----

## H

Handset Banner.....	22
Hanging up.....	24
Headset.....	29

## I

Important Safety Instructions .....	4
Installing the Phone .....	1
Intercom .....	35

## K

Key Touch Tone.....	22
Keypad Lock .....	14

## L

LCD contrast .....	22
--------------------	----

Liquid Damage.....	51
Low Battery Alert.....	53

## M

Making a call .....	24
Making a call from a Caller ID Record .....	27
Making a call with Speed Dial.....	30
Message Alert .....	41
Muting the Microphone .....	24
Muting the Ringer .....	24

## O

Out of Range.....	48
-------------------	----

## P

Personal Ring .....	21, 31
Phonebook .....	30
Placing a Call on Hold .....	24
Privacy Mode .....	34

## R

Redialing a Number .....	27
Register Handset .....	49
Register Repeater.....	50
Repeaters .....	8
Resetting the Handset .....	49
Ringer Tones .....	21
Ringer Volume .....	26

## S

Screening calls.....	41, 43
Second Telephone Line .....	7, 24
Security Code .....	41, 44
Speaker Volume .....	26
Speed Dial .....	30

## T

T-coil .....	21, 48
Talk and Standby Times .....	6, 53
Transferring a Call .....	34
Troubleshooting .....	45

## V

Voice Mail .....	23, 39
Voice Message Waiting Indicator Reset .....	39

## W

Wall Mount the Base.....	3
Wall Mount the Repeater/Charger .....	4

---

# One-year Limited Warranty

## UNIDEN XDECT R055

**IMPORTANT** Evidence of the original purchase is required for warranty service.

**Warrantor:** Uniden Australia Pty Limited ABN 58 001 865 498  
Uniden New Zealand Limited

**Elements of Warranty:** Uniden warrants to the original retail owner for the duration of this warranty its **XDECT R055** (hereinafter referred to as the Product), to be free from defects in materials and craftsmanship with only the limitations or exclusions set out below.

**Warranty Duration:** This warranty to the original retail owner only is only valid in the original country of purchase and shall be of no further effect 1 year after the date of original retail sale. This warranty will be deemed invalid if the Product is: (A) Damaged or not maintained as reasonable and necessary, (B) Modified, altered or used as part of any conversion kits, subassemblies, or any configurations not sold by Uniden, (C) Improperly installed, (D) Repaired by someone other than an authorized Uniden Repair Agent for a defect or malfunction covered by this warranty, (E) Used in conjunction with any equipment or parts or as a part of a system not manufactured by Uniden. (F) Only available in the original country of sale.

**Parts Covered:** This warranty covers for one (1) year, the Product and included accessories.

**Statement of Remedy:** In the event that the Product does not conform to this warranty at any time while this warranty is in effect, the warrantor, at its discretion, will repair the defect or replace the Product and return it to you without charge for parts and service. This warranty does not provide for reimbursement or payment of incidental or consequential damages. This EXPRESS WARRANTY is in addition to and does not in any way affect your rights under the TRADE PRACTICES ACT 1974 (Cth) (Australia) or the CONSUMER GUARANTEES ACT (New Zealand).

**Procedure for obtaining performance or warranty:** in the event that the Product does not conform to this warranty, the Product should be shipped or delivered, freight prepaid, with evidence of original purchase (e.g. a copy of the sales docket) to the warrantor at:

### UNIDEN AUSTRALIA PTY LTD    UNIDEN NEW ZEALAND LTD

Service Division  
345 Princes Highway,  
Rockdale, NSW 2216  
Fax (02) 9599 3278  
www.uniden.com.au

Service Division  
150 Harris Road, East Tamaki,  
Manukau 2013  
Fax (09) 274 4253  
www.uniden.co.nz

# Uniden®

© 2009 Uniden Australia Pty Ltd/Uniden New Zealand Limited  
Download from [www.uniden.com.au](http://www.uniden.com.au) (NZ70100655(0))

## Free Manuals Download Website

<http://myh66.com>

<http://usermanuals.us>

<http://www.somanuals.com>

<http://www.4manuals.cc>

<http://www.manual-lib.com>

<http://www.404manual.com>

<http://www.luxmanual.com>

<http://aubethermostatmanual.com>

Golf course search by state

<http://golfingnear.com>

Email search by domain

<http://emailbydomain.com>

Auto manuals search

<http://auto.somanuals.com>

TV manuals search

<http://tv.somanuals.com>