



USE AND MAINTENANCE MANUAL

MISTBLOWERS

MOUNTED MISTBLOWERS
serie EOLO - SIRIO - DEVIL - EXPO - AP APC



Read this manual carefully
before use.



Color code

01/2007

the **green** world partner

Summary

1	USING AND KEEPING THE USE AND MAINTENANCE MANUAL	4
1.1	COMPOSITION OF THE MANUAL	4
1.2	GUARANTEE	4
1.3	PRODUCT RESPONSIBILITY	4
1.4	WARNING SIGNS IN THE MANUAL AND ON THE MACHINE	4
2	SAFETY REGULATIONS AND RESIDUAL RISKS	5
2.1	INTENDED USE	6
2.2	PROHIBITED USE	6
2.3	USING CHEMICAL PRODUCTS	6
2.3.1	REGULATIONS FOR THE USE OF CHEMICAL PRODUCTS	6
2.4	RECOMMENDATIONS	6
2.4.1	TAKING PRECAUTIONS AGAINST FIRE HAZARDS	7
2.5	WEATHER CONDITIONS	7
2.6	MACHINES DESIGNED TO BE USED ONLY WITH CLEAN WATER	7
2.7	DRIVING ON THE ROAD	7
3	CHARACTERISTICS AND SPECIFICATIONS	7
3.1	TABLES OF FITTINGS ALLOWED	7
3.2	NOISE LEVEL OF THE MACHINE	8
3.3	STANDARDS OF REFERENCE:	8
4	USER'S INSTRUCTIONS	8
4.1	DESCRIPTION OF THE MACHINE	8
4.1.1	HAND WASHING TANKS	8
4.2	PRELIMINARY CHECKS	8
4.3	TRANSPORTING AND MOVING THE MACHINE	9
4.3.1	TOWED ATOMISERS	9
4.4	TRACTOR COUPLING	10
4.4.1	THREE-POINT COUPLING	10
4.4.2	HYDRAULIC CONNECTION TO THE DISTRIBUTORS	10
4.5	CARDAN SHAFT	11
4.6	PUMP	11
4.7	SUCTION FILTER	11
4.8	PRESSURE REGULATOR	12
4.8.1	COMPONENTS OF THE PRESSURE REGULATOR	12
4.8.2	GENERAL INSTRUCTIONS	12
4.9	DELIVERY FILTERS (ONLY EQUIPPED MODELS)	13
4.10	FILLING THE TANK	14
4.11	TEST WITH CLEAN WATER	14
4.12	MIXING	14
4.12.1	MANUAL PREMIXING	15
4.12.2	PREMIXER ON COVER (OPTIONAL):	15
4.13	WASHING THE ATOMISER	15
4.13.1	CIRCUIT WASHER AND TANK WASHER	15
5	BLOWER GROUP	16
5.1	AXIAL BLOWER GROUP WITH PULLEY	16
5.2	AXIAL BLOWER GROUP WITH MULTIPLIER	16
5.3	BLOWER GROUP WITH FRONT SUCTION	17
5.3.1	SINGLE-SIDE BLOWER GROUP	17
5.4	AXIAL ROTOR	17
5.5	CLUTCH	18
5.6	OPTIONAL DEFLECTORS AND ACCESSORIES	18
5.7	CANNON BLOWER GROUP	18
5.7.1	MANUALLY INCLINABLE HEAD	18
5.7.2	HYDRAULIC DRIVEN HEADS	18
5.7.3	HYDRAULIC DRIVES	18
5.7.4	OIL FEED FROM TRACTOR	18
6	SPRAYING	19
6.1	DESCRIPTION OF TYPE OF JETS	19
6.2	DESCRIPTION OF TYPE OF NOZZLES	19
6.2.1	NORMAL VOLUME CONICAL NOZZLES (OVER 500L/HA)	19
6.2.2	LOW VOLUME CONICAL NOZZLES (150-500L/HA)	19

6.2.3	ANTI-DRIFT NOZZLES	19
6.3	CALIBRATING AXIAL FAN ATOMISERS	20
6.4	CALIBRATING CANNON ATOMISERS	20
6.4.1	TREATMENTS ON TALL PLANTS	20
6.4.2	TREATMENTS ON HERBACEOUS CULTIVATIONS	21
7	HAND LANCES	21
8	MAINTENANCE	22
8.1	PROGRAMMED MAINTENANCE	22
8.2	ROUTINE MAINTENANCE	22
8.2.1	CLEANING THE NOZZLES	22
8.2.2	LUBRICATION	22
8.2.3	MULTIPLIER LUBRICATION	22
8.3	EXTRAORDINARY MAINTENANCE	22
8.4	REPAIRS	22
8.5	STORAGE IN A WAREHOUSE AND TRANSPORTATION	23
8.6	PUTTING BACK INTO SERVICE AFTER WINTER LAYUP	23
8.7	DEMOLITION AND DISPOSAL	23
8.7.1	MATERIALS FOR DEMOLITION	23
8.7.2	INDICATIONS FOR A SUITABLE TREATMENT OF WASTE	23
8.7.3	ELECTRICAL AND ELECTRONIC APPARATUS WASTE (EEAW)	23
	TABLES FOR CALIBRATING ATOMISERS Ø500-600	25
	TABLES FOR CALIBRATING ATOMISERS Ø600-650	26
	TABLES FOR CALIBRATING ATOMISERS Ø700-750	27
	TABLES FOR CALIBRATING ATOMISERS Ø800	28
	TABLES FOR CALIBRATING ATOMISERS Ø900	29
	TABLES FOR CALIBRATING ATOMISERS Ø650 TGZ	30
	TABLES FOR CALIBRATING ATOMISERS Ø800 TGZ	30
	TABLES FOR CALIBRATING CANNONS Ø450	31
	TABLES FOR CALIBRATING CANNONS Ø400-455	32
	TABLES FOR CALIBRATING CANNONS Ø400-455 TILTING HEAD	33
	TABLE 1-3 TABLES OF DELIVERY OF NOZZLES FOR ATOMISERS	34
	TABLE 4-5 TABLES OF DELIVERY OF NOZZLES FOR HAND LANCES	35
	TABLE 8 PROBLEMS, CAUSES AND SOLUTIONS	36
	TABLE 7 TABLE OF PROGRAMMED MAINTENANCE	36
	TAB.14A ALLOWED FITTINGS	37
	TAB.15A ALLOWED FITTINGS	38
	TAB.16A ALLOWED FITTINGS	39

Thank you for having chosen UNIGREEN.

The product you purchased has been designed and built with the greatest attention to the safety of the operator and the environment, nevertheless there are still some residual risks due to the nature of the product used.

For this reason we recommend reading all of this manual to avoid making mistakes in the first period of use and to get the most out of the working life of the atomiser in time, doing the programmed maintenance at regular intervals.



1 USING AND KEEPING THE USE AND MAINTENANCE MANUAL

The manual is an integral part of the machine and should be kept in a safe place where it can be reached easily for consultation.

1.1 COMPOSITION OF THE MANUAL

This manual consists of various parts to make it easier to consult by subject and to avoid repetitions; the following are part of the manual:

- a) pump handbook
 - b) pressure regulator handbook (manual or electric)
 - c) spraying computer handbook (if fitted)
 - d) optional accessories handbooks (marker, premix, cardan shaft, etc.)
- UNIGREEN reserves the right to make changes to the manual without prior warning and the normal printing cycles may vary slightly.

1.2 GUARANTEE

The enclosed card indicates the conditions of the UNIGREEN guarantee. The UNIGREEN guarantee covers the repair or replacement of parts considered manufacturing flaws, according to the unquestionable judgement of UNIGREEN, only after the authorised agent for that zone has verified the fault.

Ambit of the guarantee

The guarantee doesn't cover cases of normal wear, negligent use, poor maintenance and/or improper use.

The following materials subject to normal wear are not covered by the guarantee: gaskets and seals, diaphragms, seal rings, tubes and pipes, nozzles, pressure gauges, oil, tyres, friction material of the clutches.

Evident cases of negligence include:

work speed over that indicated in the spraying tables in the handbook (or too high for the conditions of the terrain), power-takeoff speed over 540 rpm and anything else indicated in the Use and Maintenance Manual.

Maintenance:

The guarantee is void if the maintenance indicated in the tables in this manual isn't respected, regarding the period and deadline of the interventions, washing the machine and the circuit at the end of the treatment.

Improper use:

The use the UNIGREEN machines are designed for is indicated in this manual, any other use is forbidden and makes the guarantee void.

1.3 PRODUCT RESPONSIBILITY

UNIGREEN spa is not responsible if:

- a) During the working life of the machine the normal maintenance operations aren't performed and documented as indicated in this handbook, in the enclosed handbooks of the pumps-motors-regulators-etc. and in any case as is customary for the normal maintenance of mechanical machinery.
- b) The machine is equipped with non original accessories or components or parts that aren't acknowledged by UNIGREEN as their own.
- c) The machine is equipped with original accessories or components that are unsuitable in the measurements, weight or version for the same. Please consult the page of available and recommended fittings.
- d) Not following the instructions in the manual whether totally or partially.
- e) Modifications made to the machine that haven't been authorised by UNIGREEN.

1.4 WARNING SIGNS IN THE MANUAL AND ON THE MACHINE

Below you will find all of the pictograms on the machine (see FIG.1 for their position), in order to illustrate the warnings, the prohibitions and the correct method of use.

The operations that require particular attention are shown in the images beside the text.



Composite handbook, consult the specific files on the various components



Key to the symbols

- 1- Read the Use and Maintenance manual
- 2- Stop the machine and read the manual before every intervention
- 3- Don't lubricate while running
- 4- Don't drink
- 5- Don't dispose of residue liquids in the environment
- 6- No smoking
- 7- Danger, risk or injury, don't get near the machine until the moving machine members have stopped
- 8- Danger of crushing, don't get your hands near the moving mechanical machine members
- 9- Danger, risk or injury caused by fluids under pressure
- 10- Don't climb on the machine during work or transfers
- 11- Don't climb on the tank
- 12- Don't enter in the tank
- 13- Wearing earmuffs is obligatory
- 14- Wearing a face mask is obligatory
- 15- Wearing safety footwear is obligatory
- 16- Wearing protective gloves is obligatory
- 17- Wearing protective overalls is obligatory
- 18- Use a working pressure under that indicated in red on the manometer.
- 19- Don't get your hands near the moving cardan shaft
- 20- Make sure power-takeoff of the tractor turns in the right direction and runs at the right speed.
- 21- Don't remove the protecting device with fan moving.
- 22- Material shooting off the machine, stand at a safe distance.

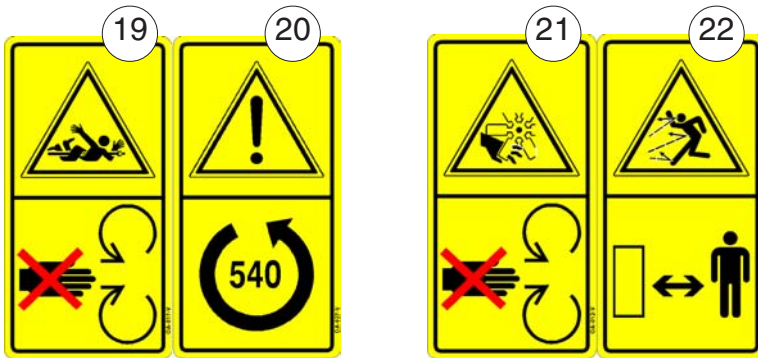

2 SAFETY REGULATIONS AND RESIDUAL RISKS

In relation to safety, the following terms will be used:

Dangerous zones: any zone inside and/or near the machine where the presence of a person exposed constitutes a risk for the safety and health of the same person.

Person exposed: any person who has their body or any part of their body in a dangerous zone.

Before starting the machine, the operator must check for any visible faults in the safety devices and the machine itself.

Never start the machine until you have told anyone in the range of action of the machine to move away and they have done so.

The protective devices must not be removed or disabled when the machine is running.

It is obligatory to keep all the plates with danger and safety signs in perfect conditions. If they get damaged or deteriorate, replace them in good time.

Replace parts believed to be faulty with others indicated by UNIGREEN. NEVER try makeshift or hazardous solutions.

Don't wear clothes, jewellery, accessories, or anything else that can get caught in the moving machine members.

Pay the greatest attention to all the warning and danger signs on the machine.

Don't use the machine for any other purpose other than that indicated in the manual.

The machine has been designed and built with the appropriate devices to guarantee the safety of the user.

In any case there are some residual risks associated with the improper use of the machine by the operator; for this purpose danger signs and symbols and prohibitions are applied near some parts of the machine (see previous pictograms).

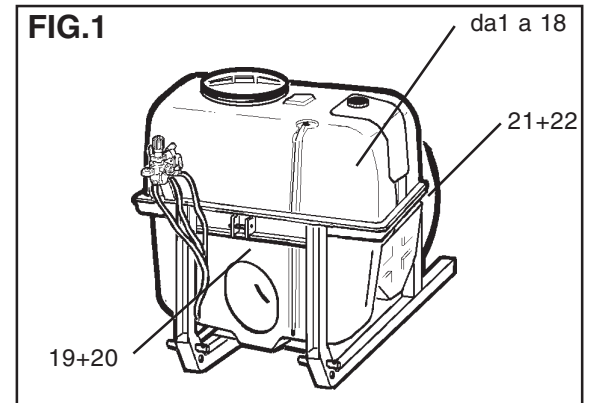

INDICATIVE POSITION OF THE WARNING SIGNS ON THE ATOMISER
NB: the position may vary on the basis of the characteristics of the model.



2.1 INTENDED USE

The sprayer in this series is built for agricultural use. The materials used are resistant to normal chemical products used in agricultural spraying (or herbicides) at the time of construction.

Any other use is not allowed and the manufacturer is not responsible for any damage caused by aggressive, dense or sticky chemicals.

THE USE OF THE MACHINE BY PERSONS UNDER 18 YEARS OF AGE IS STRICTLY FORBIDDEN

The use of liquid fertilizers in suspension is not allowed, while the use of the same in a solution is possible if requested when the machine is ordered from Unigreen and in any case changing some of the parts described in the handbooks of the regulator, such as the manometer (stainless steel), the nozzles (large diameter ceramic) and eliminating the fine mesh filters to prevent blockages.

2.2 PROHIBITED USE

Using the machine with the following products is strictly forbidden:

- = Paints of any kind and type
- = Solvents or thinners for paints of any kind and type
- = Combustibles or lubricants of any kind and type
- = LPG or gas of any kind and type
- = Flammable liquids of any kind and type
- = Liquid foodstuffs, whether for animals or humans
- = Liquids containing granules or consistent solids
- = Mixtures of various incompatible chemical products
- = Liquid fertilizer or manure in suspension with lumps and/or that is particularly dense
- = Liquids with a temperature of over 40°C
- = Any products that aren't suitable for the specific use of the machine.

2.3 USING CHEMICAL PRODUCTS

All pesticides or herbicides can be dangerous to humans and the environment if used erroneously or inadvertently.

Therefore we recommend that only suitably trained persons should use these products (license) and in any case only after having carefully read the instructions on the container.



2.3.1 REGULATIONS FOR THE USE OF CHEMICAL PRODUCTS

Some recommendations for avoiding damage and accidents:

- = Keep the machine in a suitable, protected place with no access for children or strangers
- = Handle the products with care, wearing rubber acid-proof gloves, goggles-face masks or filtering helmets, overalls made of water-repellent fabrics or TIVEK and boots made of rubber or similar materials.
- = If chemical products or mixtures of product come into contact with the eyes or are swallowed consult a doctor immediately, taking the label of the product with you.
- = Wash all clothes that come into contact with the chemical, whether diluted or undiluted, thoroughly before using them again.
- = Don't smoke, drink or eat when preparing or spraying the mix or near or in the fields treated.
- = **DON'T ENTER THE TANK:** the residues of a chemical product can cause poisoning and suffocation.
- = When spraying, respect safe distances from residential areas, water courses, roads, sports centres and public parks or paths.
- = Thoroughly wash the containers of plant protection products using the relevant accessories, rinsing several times with clean water. The liquids used for washing can be used for treatment.
- = Collect the washed containers and send them to the relevant collection centres. Never dispose of them in the environment and don't use them again for any other purpose. It is good practice to knock a hole in the bottom of the tins so they can't be used again.
- = When you have finished spraying, wash the sprayer thoroughly, diluting the residues with a quantity of water at least 10 times that of the residues, spraying the resulting mix over the treated field.



2.4 RECOMMENDATIONS

- a) Follow the instructions in this manual for the use and maintenance of the frame, tank, multiplier, blower groups and cannon.

Refer to the enclosed handbooks for the use and maintenance of the pump and pressure regulator and any accessories or motors.

b) Please contact the agent in your zone, the nearest authorised workshop or UNIGREEN S.p.A. directly for any repairs the user feels they aren't capable of performing alone. (see point 10.4)

c) Due to the complexity of the equipment and the variety of technologies used (mechanical, hydraulic, oil-pressure and electrotechnical) operators must not dismantle or modify the equipment. All of the relevant operations must be performed by specialised personnel, authorised by UNIGREEN S.p.A.

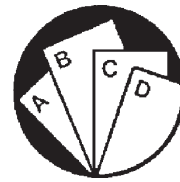

2.4.1 TAKING PRECAUTIONS AGAINST FIRE HAZARDS

Don't use naked flames or heat sources near the machines.

The atomisers are made with many materials that derive from petroleum: tanks, tubes, pipes and hoses, wheels and plastic parts; furthermore the presence of oils of various nature and residues of chemical products make them potentially flammable.

2.5 WEATHER CONDITIONS

We recommend spraying in the early hours of the morning or late in the afternoon, avoiding the hottest time of day.

Never do any spraying if it's raining or rain is forecast.

Don't spray in strong wind or in any case, in winds above 3/5 m/second.

If you have to spray in windy conditions, use relatively low pressures to obtain quite large drops that are less sensitive to drifting (being heavier the wind has less effect). There are also special anti-drift nozzles available from UNIGREEN S.p.A.; for information, please contact our offices.

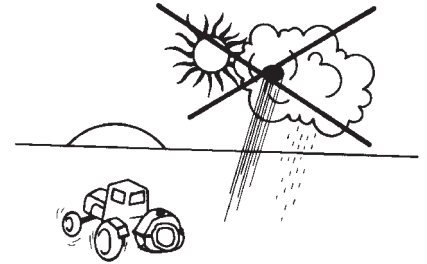

2.6 MACHINES DESIGNED TO BE USED ONLY WITH CLEAN WATER

There are versions of the machines designed only to be used with a hose reel for washing with cold clean water.

These machines cannot be used with chemical products as they don't have some of the devices or accessories that are needed to use these products safely.

These machines are identified by the word "washing" on the CE plate.

2.7 DRIVING ON THE ROAD

The towed atomisers are not specifically designed for road use. Nevertheless, many models are also available in the version homologated for road traffic with the tank empty.

You should check with your local reseller on the correct couplings to use and use tractors that meet the regulations in force.

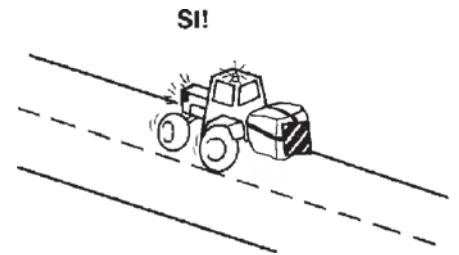

3 CHARACTERISTICS AND SPECIFICATIONS

This handbook is valid for mounted atomisers with axial fans for phytosanitary treatment in orchards and vineyards, in any case for arboreal cultivation in rows of varying nature and type.

It is also valid for cannon atomisers for the phytosanitary treatment of tall plants and forest trees such as poplars or similar.

The axial atomisers produce a mixed spray, breaking the drops with the pressure and the speed of the air produced by the fan.

These atomisers produced by UNIGREEN SPA are identified by the CE plate (FIG. 2) bearing one of the marks indicated in the tables of the allowed fittings (see the following paragraph).

3.1 TABLES OF FITTINGS ALLOWED

Tables N° 14A-15A-16A let you identify the version of your machine indicating the basic equipment and all the possible fittings available (optional).

You can also find the other fittings allowed or other versions to meet your requirements in the future.

THE EQUIPMENT DEFINED IN THE TABLES OF THIS HANDBOOK (TAB: 14A-15A-16A, pages 37, 38, 39) SHOULD BE CONSIDERED BINDING FOR THE VALIDITY OF THE DECLARATION OF CONFORMITY.

Other fittings or setups of basic components and/or optionals should be considered unsafe and therefore are not covered by the guarantee and aren't UNIGREEN's responsibility.

The same goes for fittings realised with components or accessories that aren't original UNIGREEN parts.

UNIGREEN accessories can easily be identified by the label with the yellow background "ORIGINAL UNIGREEN ACCESSORY"

TYPE :	
code:	N°
massa a vuoto:	max press. :
net mass	Kg. bar
massa totale ammessa:	Kg.
total mass	ANNO YEAR
unigreen S.p.A.	20
SPRAYING EQUIPMENT	made in Italy
via Rinaldi, 105 - Reggio Emilia ITALIA	

FIG. 2



3.2 NOISE LEVEL OF THE MACHINE

Use earmuffs to protect your ears when using the machine, below you will find the data on the maximum noise levels during work.

Atomisers with axial fan rotor

ACOUSTIC POWER LEVEL emitted by the machine with axial fan rotor: **113.5** and **118.5 dBA** respectively in 1st and 2nd gear

ACOUSTIC POWER LEVEL AT THE OPERATOR'S POSITION emitted by the machine with axial fan rotor: **89.0** and **89.5 dBA** respectively in 1st and 2nd gear

Atomisers with centrifugal fan rotor (cannon)

ACOUSTIC POWER LEVEL emitted by the machine with axial fan rotor: **111.5** and **117.0 dBA** respectively in 1st and 2nd gear

ACOUSTIC POWER LEVEL AT THE OPERATOR'S POSITION emitted by the machine with axial fan rotor: **94.0** and **97.0 dBA** respectively in 1st and 2nd gear

Readings taken in accordance with the following standards:

Machines Directive 98/37/CE (89/392 CE Dir. re-codified).

Legislative Decree D.Lgs. n°292 of the 4th of September 2002 concerning the environmental acoustic emission of machines and equipment for use outdoors.

Legislative Decree D.Lgs. 277/91 on the subject of the protection of workers against the risks deriving from exposure to chemical, physical and biological agents.

3.3 STANDARDS OF REFERENCE:

- MACHINES DIRECTIVE 98/37/CEE (89/392 CE Dir. re-codified).
- Directive 86/188/CEE: risks deriving from exposure to noise (implemented in Italy by Legislative Decree D.L 277/1991)
- DPR 547/1955: Regulations for the prevention of accidents and hygiene at work.
- Legislative Decree D.Lgs. n°292 of the 4th of September 2002 concerning the environmental acoustic emission of machines and equipment for use outdoors.
- UNI EN ISO 12100-1/Apr.2005 : Machinery safety - Fundamental concepts, general design principles - Part 1: basic terminology, methodology
- UNI EN ISO 12100-2/Apr.2005 : Machinery safety - Fundamental concepts, general design principles - Part 2: Technical principles
- UNI EN 294/July 1993: Machinery safety, safe distances to avoid reaching hazardous areas with upper limbs.
- UNI EN 349/June 1994: Machinery safety, minimum spaces to prevent crushing of body parts
- UNI EN 907/Nov.1998: Agricultural and forestry machinery - Sprayers and spreaders of liquid fertilizers - Safety.
- UNI EN 954-1/Dec. 1998 : Machinery safety - Fundamental concepts, general design principles
- UNI EN 982/July 1997: Machinery safety. Safety requisites relevant to systems and their components for hydraulic and pneumatic transmissions. Hydraulics.
- UNI EN ISO 4254-1/June 2006: Agricultural machines - Safety - Part 1: General requisites
- ISO 11684/1995: Pictograms - general principles.

4 USER'S INSTRUCTIONS

4.1 DESCRIPTION OF THE MACHINE

The atomisers consist of a structural steel frame and a polyester tank reinforced with fibreglass or high-density polyethylene. The frame is hot-galvanised. The tank is easy to empty and this makes it possible to use the machine even on hillsides.

The pumps are generally diaphragm pumps but in some cases they are fitted with pistons.

The accessories for completing the fitting, non-drip jets and ceramic nozzles make the UNIGREEN atomiser a highly qualified and efficient piece of equipment.

4.1.1 HAND WASHING TANKS

The atomisers are supplied with an auxiliary hand-washing tank with clean water and a hand tap.

This tank must always be supplied with water and the inside must be clean so you can wash any parts of the body that come into contact with the chemical product used.

Never drink the liquid inside.

4.2 PRELIMINARY CHECKS



This symbol identifies the clean water tank on the machine used to wash your hands

When you receive the machine, check that it is complete and no parts are missing.

If there are any damaged parts, inform your local reseller or UNIGREEN directly in good time.

When the machine is delivered, make sure you ask:

a) that the machine is delivered with all of its parts fitted and that the fitting meets the requisites in table N° 14b-15b-16b (pages 37, 38, 39). This procedure is necessary because for reasons of space during transportation the machine is often delivered partially dismantled.

b) that it is tested in your presence in particular checking:
= that the suction filter and the inside of the tank are clean and free of work residues.
= that the connections are made correctly following the basic layout (FIG. N° 16, page 15).
= that the hose clips and all the unions and connections are tightened properly.
= that all of the protective covers are fitted solidly to the machine, in particular the protective cover of the power-takeoff of the pump.
= that the multiplier is sufficiently supplied with lubricant oil.
= that the zone where the fan turns hasn't been bent by knocks during transportation.

4.3 TRANSPORTING AND MOVING THE MACHINE

Every time you have to lift the machine, before starting the operation, always make sure the lifting gear and the relevant tools and equipment (cables, hooks, etc..) are suitable for lifting the load and check the stability of the same.

It is forbidden to unhook and move the machine with the tank full.

The dry weight of the machine at the maximum level of fitting and with all the accessories allowed is stamped on the nameplate; use slings and lifting gear with a adequate load-bearing capacity (FIG.3).

Never lift or move the atomisers by hand if there is liquid in the tank. The machine will weigh more and the movement of the liquid can change the centre of gravity causing uncontrolled movements.

We recommend using slings as shown in the figure, the lifting points to use on the machine are indicated with the relevant symbol.

Don't lift the machine with the forks of a forklift truck because the machine can tip over due to the overhanging weight of the blower group.

Don't pass or stand under the machine when it is being lifted.

4.3.1 TOWED ATOMISERS

PARKING

Don't stand the atomiser on unstable ground or steep slopes, the machine is designed to be parked safely on compact ground with a slope of up to 8.5°

MOVING

To lift the machine, follow the instructions above.



This symbol identifies the coupling points of the machine

FIG.3

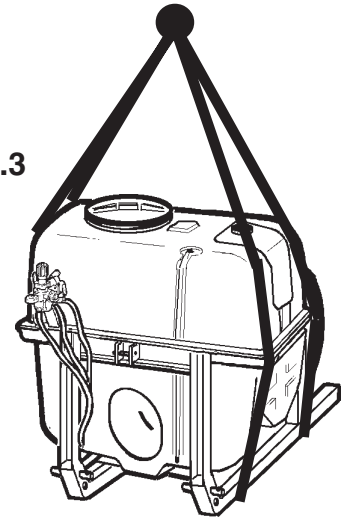

Only move and lift the machine with the tank empty

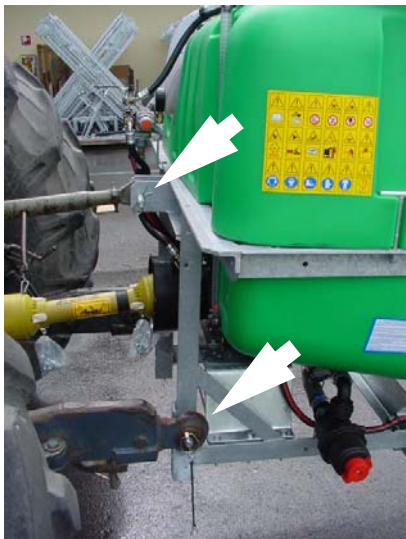

FIG. 4

Tractor coupling

4.4 TRACTOR COUPLING

The tractor must have 1 3/8 ASAE DIN 9611/A power-takeoff that runs at 550 rpm. It must have a 3-point elevator suitable for safely supporting the weight of the atomiser.

Check this by consulting the table of allowed fittings N° 14A-15A-16A (pages 37, 38, 39).

WARNING: make sure there are no persons or things near the atomiser before starting the machine and while you are using it.

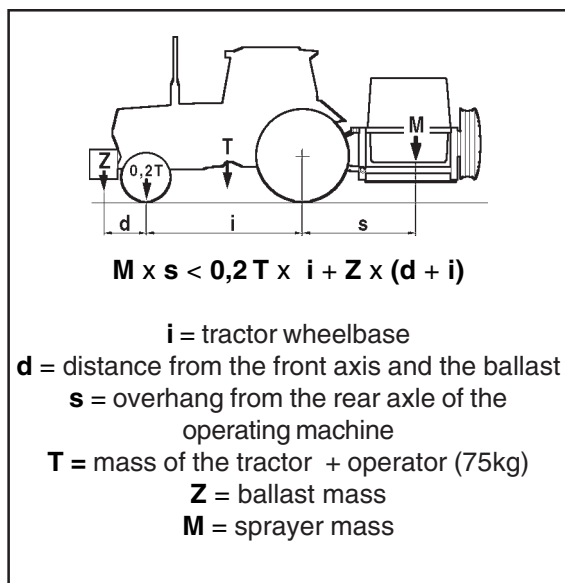

4.4.1 THREE-POINT COUPLING

a) We recommend carefully checking that the tractor is suitable for supporting the weight of the fully loaded sprayer safely.

The total weight of the sprayer with all of its accessories and fittings is indicated on the nameplate in FIG. 2 and also (in the version with the maximum fittings allowed) in tables N° 14A-15A-16A (pages 37, 38, 39).

For verification use the formula shown here.

Non-observance can result in a very dangerous situation as the tractor will lose steering sensitivity and can tip over when driving uphill or over bumps.

b) Check the diameter of the elevator coupling pins. If necessary position the double diameter pins correctly; there are also appropriate adapter bushes available.

c) Adjust the length of the third point tie-rod correctly so the sprayer is perfectly vertical in normal working position.

d) Check for the presence of the safety pins that stop the arms of the tractor jumping off the connecting pins.



FIG. 5

4.4.2 HYDRAULIC CONNECTION TO THE DISTRIBUTORS

Machines that need a hydraulic connection to drive the movements of the cannon are equipped with 1/2", "Push-Pull", quick-fit male couplings. You can connect the pipes by simply pushing them in, making sure you:

- do so only with the engine turned off;
- lower any tools connected to the elevator of the tractor;
- carefully clean the two parts that will be coupled

Warning: the hydraulic cylinders used are the "Double Effect" type. Consult the use and maintenance manual of the tractor.

4.5 CARDAN SHAFT

In some models this is supplied on request.

The cardan shaft must bear the CE mark.

It must always have its own instructions that must be followed scrupulously and it should come with a cover bearing the mark, integrated in every part.

You should have previously checked the length to avoid:

- = if it is too long, DANGEROUS THRUST ON THE PUMP SHAFT
- = if too short, the POSSIBILITY OF DANGEROUS BREAKAGES

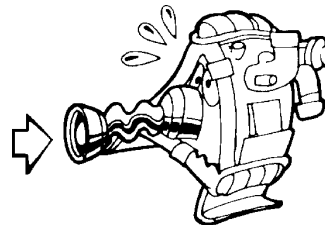

FIG. 6

THE MINIMUM OVERLAP OF THE TWO TELESCOPIC TUBES MUST NEVER BE LESS THAN 1/3 OF THE LENGTH OF THE TUBES.

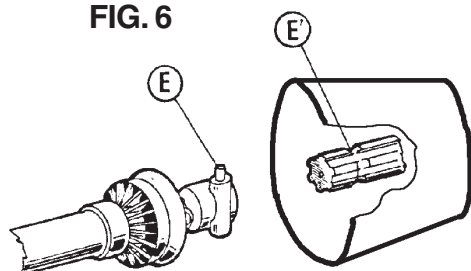
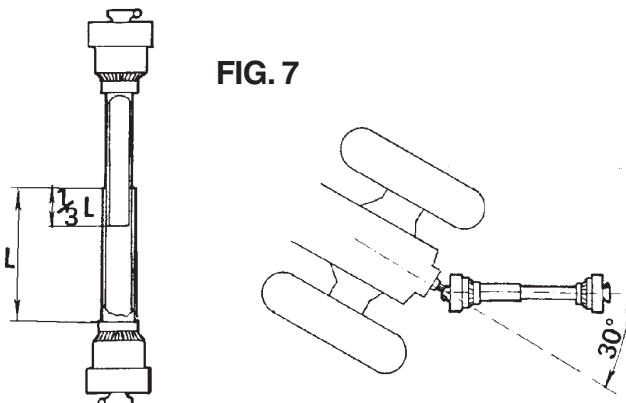

FIG. 7



The power that can be transmitted by the cardan shaft must be at least equal to that required to run the atomiser.

These power ratings are indicated in tables N° 14A-15A-16A (pages 37-38-39).

- a) Hook any safety chains to solid anchor points
- b) Check that the button or ringnut "E" (FIG. 6) is correctly engaged and blocked both on the pump side and on the tractor side.
- c) Don't exceed an inclination of 30° in any direction for any reason
- d) With the machine stopped, periodically grease the spiders and the pipes, keeping the connecting zone particularly clean.
- e) Avoid letting the end of the cardan shaft come into contact with the ground with the machine stopped; use the relevant support on some versions for this, if your machine has no support, hook the external safety chain to a part of the frame of the machine (ex. control unit support).



NEVER USE THE CARDAN TRANSMISSION IF THE FOLLOWING PROTECTIVE COVERS ARE MISSING:

- TRACTOR POWER-TAKEOFF PROTECTIVE COVER
- CARDAN SHAFT PROTECTIVE COVER
- FIXED PROTECTIVE COVER ON THE PUMP SHAFT

4.6 PUMP

When using the pump scrupulously observe the instructions in the enclosed handbook supplied by the manufacturer.

The pump can be identified by the ratings plate on the same; the main data on the pressure and delivery are easy to find on this plate.

Normally the pumps mustn't exceed 550 RPM; a higher speed won't improve performance but there is a risk of compromising the life and safety of the pump.

There is a safety valve on the pump, calibrated to prevent overpressure. Don't tamper with this valve for any reason and don't block or obstruct the pipes connected to it in any way.

Don't use the sprayer without having consulted the enclosed handbook.



4.7 SUCTION FILTER

The sprayer is fitted with a suction filter with filter cartridges that have roughly a 50-gauge mesh, which is equivalent to a hole of 0.4 at 0.35 mm.

An efficient filter lets the sprayer work properly.

You should periodically check that the filter cartridge is clean, this check should be done more often if there are impurities in the liquid.

To inspect the filter cartridge wear rubber acid-proof gloves as the liquid in the filter can come into contact with your hands when you open the filter.

Don't perform this operation with the pump running as the depression produced blocks the cover preventing the removal.

Before removing the cover of the filter, make sure that the same is isolated from the tubing by unscrewing the relevant rear valve (FIG. N°8).

After washing the cartridge, reassemble the cover making sure you connect the same to the circuit again, using the valves described above in the opposite order.

WARNING!: Don't disperse the washing residues in the environment!!

FIG. 8

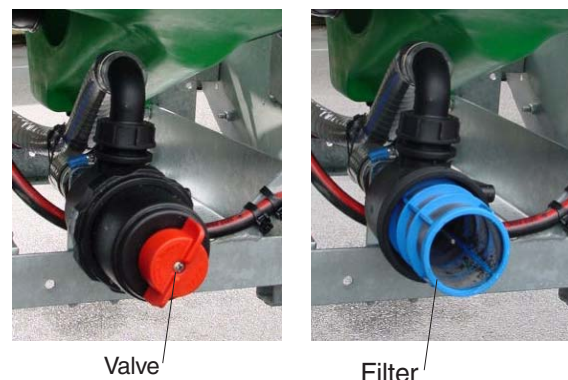

Valve

Filter

Don't use the sprayer without having consulted the enclosed handbook.



4.8 PRESSURE REGULATOR

To use the pressure regulator, follow the instructions in the enclosed handbook scrupulously. The pressure regulator controls all of the most important spraying functions, the thorough knowledge of its functions makes work easier and more precise.

The working pressure and the maximum pressure of the sprayer are determined by the pressure regulator which also protects the circuit from overpressure in any work conditions. (In serious but very rare cases, if the connecting pipes get blocked the pressure relief valve lets the pressure off)

In some setups there may be a pump that can reach a pressure of 50 bar controlled by a regulator designed for 20 bar. In this case the maximum pressure that can be reached is 20 bar.

The regulators can be manual, mounted on the sprayer or at a distance to make the controls easier to use; or electrical with a control panel in the cabin.

There are also regulator versions with mechanical remote controls with a cable. If the tractor has a waterproof cabin the use of electrical controls is obligatory.

4.8.1 COMPONENTS OF THE PRESSURE REGULATOR

Below you will find the indications for the main models fitted on Unigreen products.

A main ON-OFF command: "open" lets the fluid flow into the circuit in use; "closed" empties the tank.

B maximum pressure valve: adjusted by hand with the relevant knob (drains the excess liquid when the set pressure is reached).

C jets section tap: opens the corresponding jet boom or drains to the compensation regulator (G).

D auxiliary tap: can be used for various accessories (it is always manual).

E volumetric pressure valve (proportional):

(when present) it regulates the spraying pressure. The valve automatically compensates variations in speed (within the scope of the same gear ratio), keeping the quantity of liquid supplied per surface unit (litres/hectare) unchanged.

F self-cleaning filter: filters the delivery liquid.

G compensation regulators: suitably regulated, these make it possible to keep the pressure constant when one or more sections of jets is closed, they don't influence treatments with the boom fully open.

H manometer: indicates the working pressure.

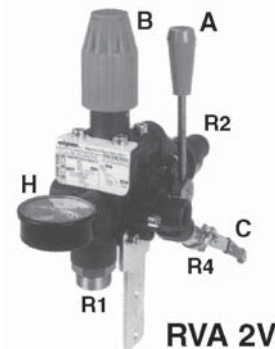
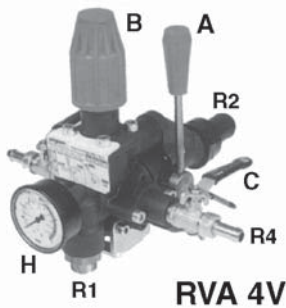

Connections:

R1 supply union

R2 drain union

R3 volumetric drain union

R4 jets section delivery union

R5 auxiliary delivery union

Control box for GCP ELETTRICO electrical regulators

I1 main control valve switch

I2 volumetric pressure valve switch (proportional)

I3 jets section valves switches

4.8.2 GENERAL INSTRUCTIONS

When using the pressure regulator, scrupulously observe the instructions in the enclosed handbook, below you will find generic indications for the major models fitted by Unigreen.

All the regulation and adjustment tests must be carried out with clean water.

Pressure regulators without a volumetric valve (GCP3-way - GRH-RVA)

Adjusting the maximum pressure valve

= put main control **A** in the drain position ("OFF").

= loosen the hand wheel of maximum pressure valve **B** completely (anticlockwise).

= start the pump by activating the power-takeoff of the tractor at 540rpm

= open main control **A** (position "ON"), the manometer will be activated

= open all of the section valves **C** (position "ON")

= adjust maximum pressure valve **B** to the working value (in any case less than the safe maximum pressure the system can reach).

Pressure regulators with a volumetric valve (GCP ELETTRICO)

Adjusting the maximum pressure valve

- = put main control **A** in the drain position ("OFF").
- = loosen the hand wheel of maximum pressure valve **B** completely (anticlockwise).
- = open volumetric valve **E** completely.
- = start the pump by activating the power-takeoff of the tractor at 540rpm
- = open main control **A** (position "ON"), the manometer will be activated
- = open the drain tap on filter **F** slightly (only **GCP ELETTRICO**).
- = close volumetric valve **E** completely. If the pressure rises over the maximum limit of the system, make sure maximum pressure valve **B** is open (see previous indications)
- = open all of the section valves **C** (position "ON")
- = adjust maximum pressure valve **B** to a value over that of the working pressure (generally 10-14 bar) and in any case lower than the safe maximum pressure that the system can reach.

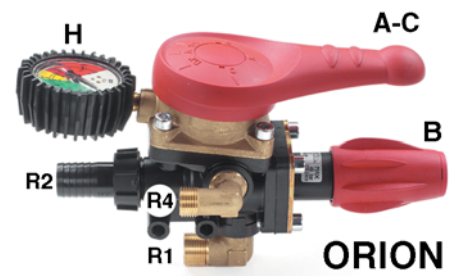

Adjusting the volumetric pressure.

- = with the volumetric pressure valve **E** adjust the pressure to the value the treatment will be done at (the pressure is indicated on the nozzles tables on the basis of the tractor speed and litres/hectare to spray)

Warning! The working pressure must be adjusted with the volumetric valve and not with the maximum pressure valve. In the case the working pressure is too near to the calibrated pressure of the maximum pressure valve, the proportional valve may not be able to compensate the speed variations correctly.

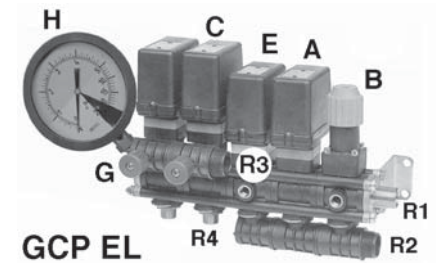

Adjusting the compensated returns

- = close only one tap of section **C** (position "OFF").
- = adjust the corresponding compensator **G** until you return to the pressure set previously (displayed on the manometer).
- = open and close the tap of section **C** and check that the pressure remains constant.
- = repeat the above operations for all the section taps.

If the types of nozzles aren't changed the regulations carried out will guarantee a constant spraying of the liquid also per treatments that are done at different working pressures.

NB: if the type of nozzle is changed then the calibrating will have to be done again.

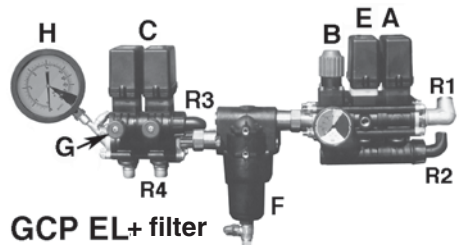

4.9 DELIVERY FILTERS (ONLY EQUIPPED MODELS)

This is particularly useful when using small nozzles (low volume), they are normally mounted on the jet booms and have a filter cartridge with a 40-gauge mesh (the equivalent of a 0.4 mm hole).

In the RV version, the standard cartridge has a 86-gauge mesh (the equivalent of a 0.25mm hole) and another manometer is mounted after the cartridge to make fault-finding easier.

At the end of each treatment cycle you should clean the cartridge: turn the jets to the closed position, put the command under pressure and open the tap under the filter to drain the tank for a few minutes.

You should clean the cartridge by hand periodically, on the basis of the product used. Stop the pump to clean. Wear rubber gloves and the other personal protective equipment when cleaning.

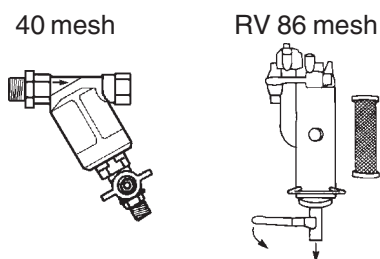
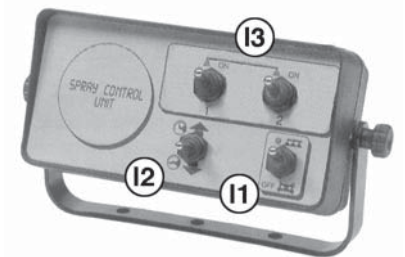

FIG. 9



FIG. 10

4.10 FILLING THE TANK

The machines for defensive crop treatments, in consideration of the safety of persons, animals and the protection of the environment, must only be filled indirectly from open water courses and only by free-falling water from the waterworks.

The pipe used for filling must never come into contact with the liquid inside the tank and therefore the water must always fall over the upper edge of the filling inlet and through the filter installed on it.

The tank is fitted with a transparent graduated band that shows the exact quantity of liquid inside. This reading is precise if the tank is on flat ground; the actual total capacity coincides with the highest number. All the filling systems fitted by Unigreen on their production machines or on request are antipollution and stop the liquid overflowing out of the tank.

a) FILLING WITH THE SUCTION FILTER (Fig. 10 - Fig. 11).

If the 3-way deviator isn't fitted you can fill the tank using the coupling on the cover of the suction filter. Unscrew the rear wing nut of the filter and using a G1"1/2 threaded union, connect pipe T with the floating filter to the coupling. Also in this case the filling speed in litres/minute is equal to the delivery of the pump.

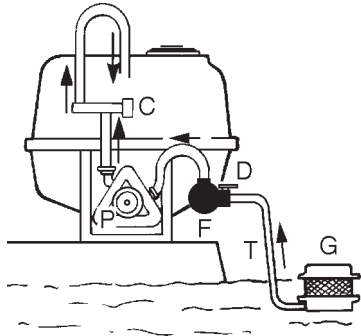

FIG. 11

b) FILLING WITH THE ANTIPOLLUTION EJECTOR (Fig. 12)

If you are filling with an antipollution hydroejector (mounted as standard on some models) then you should proceed as follows:

- = put roughly 20-30 L of water in the tank and start the pump.
- = remove the cap of ejector E and insert filling pipe T.
- = place the other end of the hose, on which you fitted filter G, in the watering point.
- = open the tap that supplies the ejector (on pump P or pressure regulator C).
- = increase the pressure until it reaches a value which is sufficient to suck up the liquid.
- = visually check the level of the liquid inside the tank and after filling disconnect pipe T from the ejector, close the tap and replace the cap.

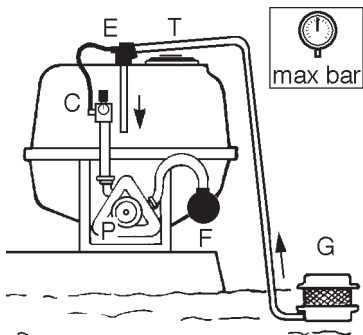

FIG. 12

WARNING: using the taps on the pump or in any case on the front of the machine puts the operator near the cardan shaft. Despite the presence of CE standard protective covers you should take great care.

4.11 TEST WITH CLEAN WATER

It is good practice to do a test with clean water (without chemical product in the tank) before the first treatment to make sure the atomiser is working properly and to get to know the controls. For instructions on how to proceed with the treatment see the chapter SPRAYING.

4.12 MIXING

The active principle can be mixed using the relevant stirrers before and during the treatment. Correct mixing and stirring is the basis of the correct distribution on the crops. We recommend some useful accessories such as the premixer for powders and liquids (see the following paragraph).

To mix the product in the tank proceed as follows:

a) high-pressure machines from 30 to 60 bar (FIG. N° 13): run the stirrer (or ejector) for roughly 10-15 minutes at the maximum pressure available

b) low pressure machines, max 20 bar

= with a drilled pipe on the drain, run the pump at roughly 540 RPM with the pressure regulator on drain for at least 10-15 minutes. (FIG. N° 14)

= with the stirrer on a delivery, run the pump supplying the stirrer (or ejector) at the maximum pressure available for at least 10-15 minutes. (FIG. N° 13)

Some models with very small tanks aren't equipped with mixers, you should use the drain of the pressure regulator: run the pump at roughly 540 RPM with the pressure regulator in the drain position for at least 10-15 minutes. (FIG. N° 15)

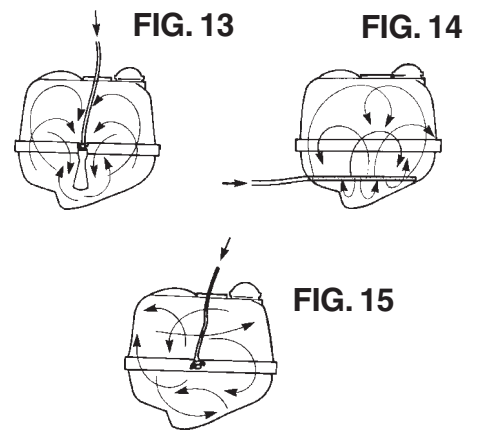

4.12.1 MANUAL PREMIXING

Dilute the active principle by hand before introducing it into the tank, (you must wear suitable protective clothing such as rubber gloves, a mask or goggles, overalls, etc.).

4.12.2 PREMIXER ON COVER (OPTIONAL):

Open the cover and pour all of the chemical powder into the filter, close the cover and open the supply tap until all of the powder has dissolved.



4.13 WASHING THE ATOMISER

After every treatment, thoroughly clean the equipment, washing it with water inside and out. Dirty equipment is very dangerous for people and in particular for children.

Discharging the residues of washing in the environment without taking precautions is forbidden as this pollutes water courses. Distribute the residues on the field or the crops where they won't cause any damage.

4.13.1 CIRCUIT WASHER AND TANK WASHER

Some machine models are fitted with a circuit washer tank (FIG.16). This tank must be filled with clean water and used to rinse the entire circuit including the suction, delivery, pump, pressure regulator, jets and nozzles. Thanks to the practical rotary nozzle it also rinses the inside surfaces of the tank.

NB: To completely clean the tank and the pipes of any residues of the various active principles, we recommend adding 2kg of soda to the washing liquid for every 100 L of water.

At the end of the treatment, wash the circuit and the tank.

- Stop the diaphragm pump disengaging the power-takeoff.
- Check you have filled the circuit washer tank (C).
- Make sure the main control of the pressure regulator is OFF and that all the boom sectors are closed.
- Turn suction deviator A to the circuit washer position (H₂O).
- Start the diaphragm pump by engaging the power-takeoff.
- Increase the engine speed until all of the liquid in circuit washer tank C has been sucked up.
- Turn the diaphragm pump off and turn deviator A to the work position (TANK).
- Turn the main control to ON, so there is pressure in the circuit.
- Start the diaphragm pump again and use the tank washing tap on the regulator (or on pump P) that supplies jet B.
- After a few minutes you can close the tank washing tap
- Distribute the washing residues over a portion of the field where it won't cause damage.
- After you have finished washing, stop the diaphragm pump.

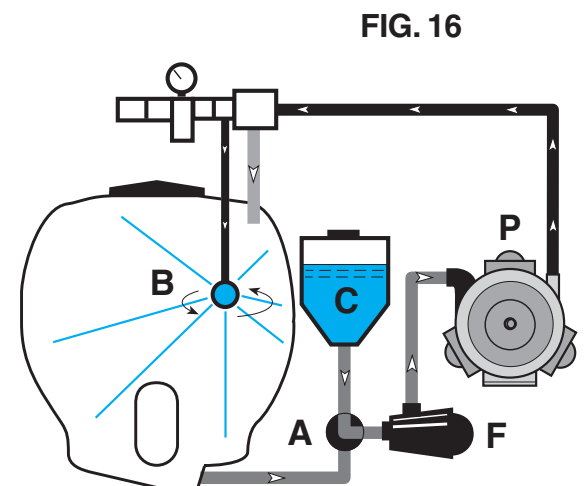

WARNING: using the taps on the pump or in any case on the front of the machine puts the operator near the cardan shaft. Despite the presence of CE standard protective covers you should take great care.



This symbol identifies the clean water tank on the machine used to wash the circuit

NB: at the end of the washing cycle, if there is the risk of frost, pour roughly 500 grams of normal antifreeze for auto vehicles into the tank.



Belt tensioning system

FIG. 17

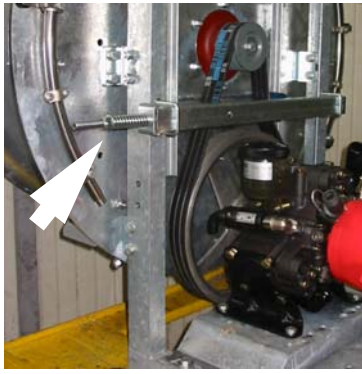

Belt tensioning system

FIG. 18



FIG. 19A



FIG. 19B



Speed change lever

5 BLOWER GROUP

All the atomisers have a high speed fan rotor. You must take great care and beware of the effects that this can provoke: such as the aspiration and projection of foreign bodies which, although of a small size, can be very dangerous especially for the eyes and face.

5.1 AXIAL BLOWER GROUP WITH PULLEY

The atomisers that have a drive transmission between the pump and fan with pulleys are equipped with a neutral gear; the multiplied ratio is 1:4.26, the rotation speed of the fan is 2,300 RPM.

You should periodically check the tension of the belts; if they become too slack you should tension them again.

To do this for the models equipped with a specific system belt tensioning system, use the screw indicated to the side (FIG. 17).

For all the other models use an adjustable wrench on the nut indicated in the figure to the side to move the base and tension the belts (FIG. 18)

5.2 AXIAL BLOWER GROUP WITH MULTIPLIER

The transmission of the drive from the pump to the fan is done through a multiplier with one or two neutral gears.

Normally the rotation speed of the fan is 1950 RPM in first gear and 2500 RPM in second in the multiplier with 2 gear ratios (multiplied ratios 1:3.6 - 1:4.6) and 2,500 RPM in the multiplier with one gear ratio (1:4.6)with the power-takeoff running at 540 RPM.

You can change from one gear to the next with the lever on the multiplier, made accessible through the opening on the side in the rear left part of the machine or at a distance on the right side. The lever has 2 or 3 positions depending on the number of gears and the central position is neutral (to use only the pump without the fan).

There are two models of blower groups with rear suction:

- **Axial blower (FIG19A)**: used for treatments similar to traditional multiplier blower groups, with delivery of the air in a circular crown.

- **Tangential blower**: for use in small and medium espalier rows of vines. There are pulley drive versions or multiplier versions, adjustable jets can be mounted to spray the vegetation at various heights.

WARNING: the gear change lever must only be used with the power-takeoff disengaged and the fan stopped. If it is difficult to engage, turn the cardan shaft slightly by hand to find the right position of the lever (make sure the tractor is turned off).

There are two deflectors (one on the right and one on the left) in the bottom part of the delivery outlet of the fan groups which define the direction of the airflow; lower if the deflector is lowered and higher if the deflector is raised. For the system to work properly it should be set up as follows: the left deflector (looking at the atomiser from behind) raised and the right one lowered in machines with a multiplier, vice versa in those with a pulley (as the fan turns in the opposite direction).

For the maintenance of the multiplier (see point 8.2.3 Multiplier Lubrication).

WORK TEMPERATURE

Heat is generated by the friction between the various moving components and on the basis of the power transmitted. The temperature of the multiplier or disengaging box depends on the capacity to dissipate heat to the surrounding environment and therefore the surfaces involved in the heat exchange and the environmental conditions.

The specifications refer to environmental conditions with a temperature between -10° $+50^{\circ}\text{C}$ (14°C -122°F).

The working temperature limit of the box is 90°C (200°F) established to prevent the ageing of the seals and guarantee a sufficient viscosity of the oil. The heat makes the air in the box expand and therefore increases the pressure inside. The correct use of the oil seals is guaranteed up to an internal pressure of 0.5 bar. Boxes designed to be used for particularly heavy duty work are equipped with a breather cap that can be fitted on any cast iron box on request.

5.3 BLOWER GROUP WITH FRONT SUCTION

These models have front suction with delivery of the air obliquely to the rear of the machine. This characteristic guarantees greater penetration into the vegetation (see fig. 20A-20B)

There are two models of blower groups with front suction:

- **Axial fan:** used for treatments similar to traditional multiplier blower groups, with delivery of the air in a circular crown (fig. 20A-B).

- **Tangential fan:** for use in small and medium espalier rows of vines. There are pulley drive versions or multiplier versions, adjustable jets can be mounted to spray the vegetation at various heights.

The vanes of these blowers have an inclination that can be adjusted by 5° , with positions from 20° to 40° (as standard this is set at 35°); to adjust the inclination you have to order the appropriate adjustment discs. This operation must only be performed by qualified personnel respecting the position of the single vanes so as not to vary the dynamic balance of the fan; unbalanced blowers can cause rapid wear of the multiplier and the fan rotor itself making the machine unsafe.

5.3.1 SINGLE-SIDE BLOWER GROUP

The sprayer can be equipped with a single-side blower group like the one shown in figure 21. The operating principle is similar to that of the blower group with front suction, the only difference being that the treatment is only on one side.

5.4 AXIAL ROTOR

Generally the new models of rotors are fitted with 7 vanes made of aluminium or nylon + fibreglass and the vanes have a variable inclination from 20° to 40° with step adjustment by 5° (in some cases there are drilled reference discs) FIG. 22.

The angular movement of all of the vanes, if done correctly, doesn't change the dynamic balance of the blower group.

To change the inclination of the vanes (as standard this is set at 35°) proceed as follows:

a) Remove the protective grill.
b) Unscrew screws **A** that hold the spinner (central cover), each vane has two blocking screws **B** at the side, one on the right and one on the left. Unscrew the two screws enough to turn the vane the degrees necessary (replace the drilled discs when fitted). To make the adjustment easier, there are reference notches on blocking element **C**.

c) After you have positioned the vane, perform the same operation on the next one and screw the screws of the first in enough to block it in place.

d) Repeat the operation on all the vanes and after you've checked that all have the same angle, reassemble the spinner and the protective grill.

The fan is balanced dynamically; the different numbers of washers under the screws blocking the vanes are for balancing.

You shouldn't change the position of the washers or add or remove any. Only tighten down the screws with moderate force as they have an aluminium thread.

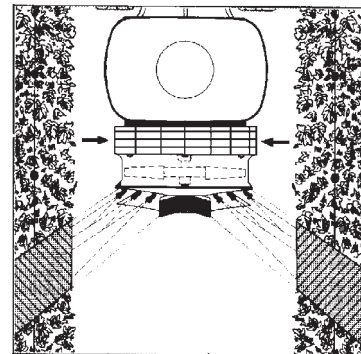

FIG. 20A



FIG. 20B



FIG. 21

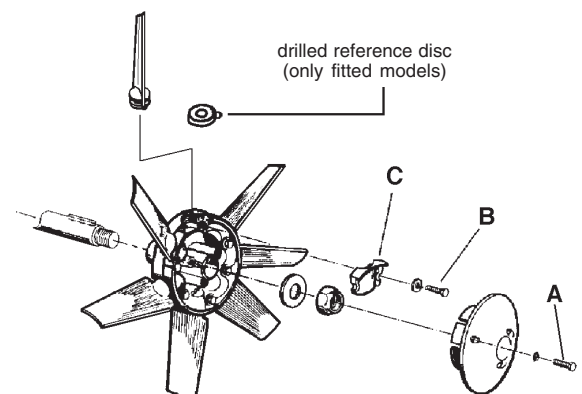

FIG. 22

FIG. 23



5.5 CLUTCH

Big aluminium and nylon blowers have a centrifugal type clutch that makes it possible to engage the fan rotor gradually. This prevents jerky starts, due to the inertia of the fan rotor, which can have a negative effect on the transmission. For the centrifugal clutch to work properly the speed of the power-takeoff mustn't be less than 450 rpm, especially if you are using the first gear of the multiplier. Generally clutches with shoes/plates made of sintered material with a high coefficient of friction are fitted, on some low power models rubber clutches may be fitted.

FIG. 24

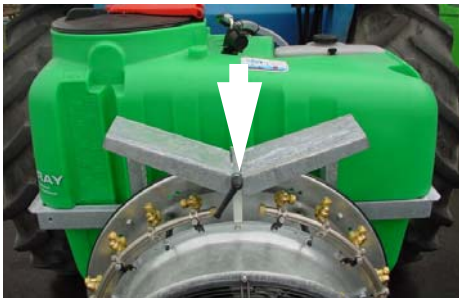

5.6 OPTIONAL DEFLECTORS AND ACCESSORIES

The atomisers are fitted with deflectors underneath for the optimal regulation of the airflow towards the zone to be treated. To adjust these, simply pull or push the deflector, positioning it in the desired way (FIG.23).

Top deflectors can also be supplied on request to improve the regulation of the airflow towards the lateral zones without dispersing the product upwards. To adjust these, simply loosen the black lever (shown in figure 24), position the deflectors and lock the lever again.

5.7 CANNON BLOWER GROUP

The cannon blower group is equipped with a multiplier similar to the normal axial blower groups and all of its operating characteristics are the same. The main difference with respect to the axial blower groups is that the centrifugal fan rotor is made of galvanised steel, the fan rotors in this type are fixed and can't be adjusted, for the clutch see the previous paragraph. This fan rotor can usually produce a delivery which is much higher with a very high speed airflow (Fig. 25).

The cannon fan is mounted on a thrust block that can be adjusted by hand by unscrewing the relevant locking screw. This adjustment must be done with the fan rotor stopped because the high speed of the air make the movement of the fan dangerous.



FIG. 25

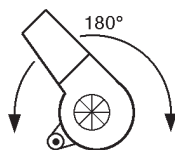
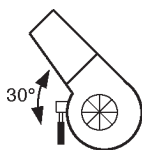
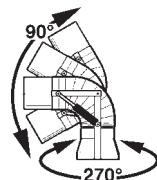
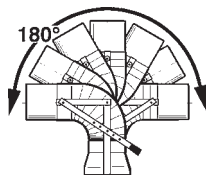

5.7.1 MANUALLY INCLINABLE HEAD

The cannon blower group can be equipped with a pivoting head (max inclination 180°) adjustable by hand.

5.7.2 HYDRAULIC DRIVEN HEADS

On request hydraulic pivoting (inclination 90° roughly) and rotating (max rotation 270°) heads are available.

5.7.3 HYDRAULIC DRIVES

The cannon fans can be equipped with hydraulic drives: with the cylinder fitted directly (30° inclination roughly) or a motor with a pinion and chain (180° inclination roughly).

5.7.4 OIL FEED FROM TRACTOR

(for hydraulic systems)

Connect the delivery and discharge quick-fit coupling to the respective connections, respecting the direction of flow.

The distributor inlet pipe is connected to the aluminium flow separator valve next to the distributor.

The flow separator must be adjusted correctly so it sends less than 4-5 L/1° to the distributor.

To prevent the cylinders moving at a dangerous speed, adjust the relevant chokes near the cylinders. If the registration ringnuts aren't visible then fixed chokes are fitted. The chokes are fitted on the discharge line of the movement to slow.

Any impurities in the oil could block the chokes and as a consequence block the cylinder; remove the dirt if necessary. The maximum pressure valves of the distributors are regulated to a pressure of around 150 bar.



To prevent the excessive heating of the oil we recommend supplying the distributor of the sprayer only when the cylinders are being used.
 We recommend having qualified personnel do any adjustments.
 Pay attention to the integrity and efficiency of the hydraulic components and in particular to the pipes to prevent the risk of bursting.
 Do a full check on the pipes and components at least once a year, we recommend replacing hydraulic pipes every 3-4 years.

6 SPRAYING

6.1 DESCRIPTION OF TYPE OF JETS

Various types of jets are fitted; with a single or double head.
 Generally they have a non-drip diaphragm and are made out of brass, suitable for pressures up to 40 bar, some models are nickel plated.
 The jets can be equipped with different types of nozzles, changing the locking ringnuts. The jets used normally have high volume, Ø18, ceramic plates and low volume conical nozzles (Albuz ATR or Teejet TXB). The jets for cannons have a jet holder with adjustable delivery and spray that has high volume, ceramic plates, Ø15 instead of 18.

All the jets normally used have three positions (FIG. 26):

- a) spray - if the nozzle is pointing outwards, away from the blower group, parallel with the non-drip valve
- b) closed - if the nozzle is at 90° with respect to the non-drip valve or, for the single jet if it is facing inwards towards the blower group
- c) nozzle second spray - when these are pointing towards the outside of the blower group parallel with the non-drip valve.

6.2 DESCRIPTION OF TYPE OF NOZZLES

The nozzles are extremely important to obtain a correct distribution on the vegetation to be treated. Poor quality or worn nozzles have a tendency to create unevenly treated strips.

The nozzles are produced in various sizes, to work with a precise pressure range, to create certain types of larger or smaller drops; using nozzles for a purpose they are not envisaged for prejudices the precision and duration of the nozzles.

6.2.1 NORMAL VOLUME CONICAL NOZZLES (OVER 500L/HA)

Generally made of ceramics, these nozzles consist of various parts; the actual nozzle, the stainless steel slinger and a series of seals. They are particularly resistant to wear and are designed to work also at high-pressure (25-45 bar) producing drops of an average size with strong turbulence. This turbulence makes them suitable for penetrating luxuriant vegetation and so they are suitable for fungicides and insecticides. There are various sizes and the capacities are indicated in table N° 1, page 33.

6.2.2 LOW VOLUME CONICAL NOZZLES (150-500L/HA)

Made of two ceramic pieces with colour-coded plastic inserts, they are available in various sizes identified by the colour (see tables 2 and 3 page 33).

They have been specifically designed to obtain a large number of small drops with strong turbulence even at low pressures (2-3 bar). This turbulence makes them suitable for penetrating luxuriant vegetation and so they are suitable for fungicides and insecticides. The nozzles of the TR Lechler and TXA Teejet series are in this category.

6.2.3 ANTI-DRIFT NOZZLES

Specific anti-drift nozzles are available from Unigreen. The main characteristic of these nozzles is that they eliminate the fog effect caused by the presence of drops that are too small and are particularly sensitive to drifting. For further information please contact Unigreen for the relevant instruction handbook.

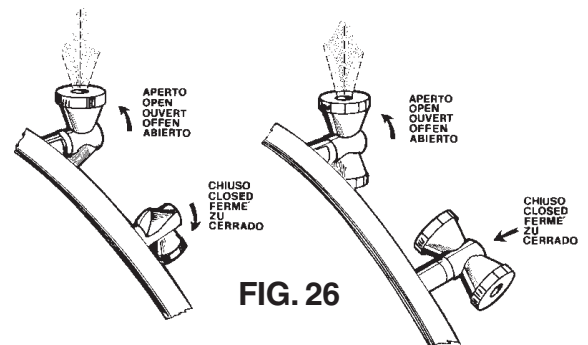

6.3 CALIBRATING AXIAL FAN ATOMISERS

(Tables on pages 25 - 30)

The tables on pages 25-30 let you easily calculate the distribution in litres/ hectare of the atomisers with the standard fittings, proceeding as indicated below:

- Choose the table relevant to the blower group of the atomiser in question (the main reference is the number of jets)
- Find the distance between the rows of the vegetation and the diameter of the nozzles used (ceramic plates, TR or TXA).
- In the horizontal strip, choose the working speed and the distribution in litres/ hectare and on the vertical scale find the pressure to use.
- Adjust the pressure to obtain the treatment required.

If the distance between the rows is different from that in the table you can easily calculate the distribution in proportion: for example with a distance between the rows of 8 m, divide the figure for the litres/hectare of the distance between the 4 m rows by half, with a distance between the rows of 2.5 m double the figure for the distance between the 5 m rows.

The last line of the table indicates the overall delivery of the fan.

If the atomiser is fitted with non-standard nozzles, the spraying tables of the single nozzles per atomiser are on page 34.

To calculate the distribution in litres/hectare, use the following formula:

$$Vd = \frac{600 \times Q}{I \times V}$$

where:

Vd = volume to distribute (L/ha)

Q = sum of the nozzles delivery (L/min)

I = distance between the rows (m)

V = tractor speed (Km/h)

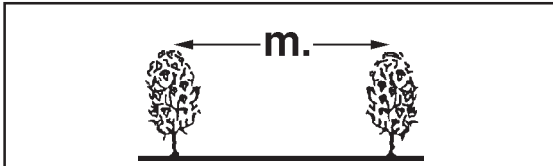

NB: for calculating a different space between rows simply multiply the litres/hectare value by the corresponding width indicated in the table and divide it by the new width.

EXAMPLE:

in the table: 907 Lt/ha with a space between the rows of 3m

$\frac{907 \times 3}{2,8} = 971$ Lt/ha with a space between the rows of 2.8m

EXAMPLE:

Distance between the rows: **5 m**

Speed: **6 Km. / h**

Working air pressure 30 bar

Fan \varnothing 800 with 14 standard, high volume nozzles (\varnothing 1.0)

Q total delivery of the nozzles (Tab. 1 page 34) $2.96 \times 14 = 41.44$ L/min

$$Vd = \frac{600 \times 41.44}{5 \times 6} = 829 \text{ L/ha}$$

N.B. : Depending on the season the vegetation may be more or less luxuriant; bear this in mind before starting the treatment. If the plants don't have much foliage you should diminish the quantity of litres per hectare using lower pressures or closing one or more jets of the fan.

6.4 CALIBRATING CANNON ATOMISERS

(Tables on pages 31-33)

Atomisers with a cannon blower group are mainly intended for treating forest trees or other tall plants that it is impossible to drive into with the sprayer (for example tobacco or similar cultivations). They are also frequently used in cultivation under mobile greenhouses.

When shooting the atomised chemical mix at distances, that can even be over 40 m, it isn't possible to verify with the exact distribution on the area treated. Due to the effect of the wind, the presence of turbulence and the obstacle of the same plants being treated, we don't recommend using cannons with chemical products that need to be distributed with great precision. Don't use herbicides or similar products.

6.4.1 TREATMENTS ON TALL PLANTS

a) Use the tables of pages 31-33 choosing the one relevant to the type of cannon to use and the number of jets.

b) On the last line choose the delivery in L/minute that goes with the chosen working pressure.

c) Then spray the litres desired on the plant defining the necessary treatment time. When treating a poplar grove or in similar situation there are photocells for the automatic management of the opening of the jet in the presence of the plant to treat, available on request.

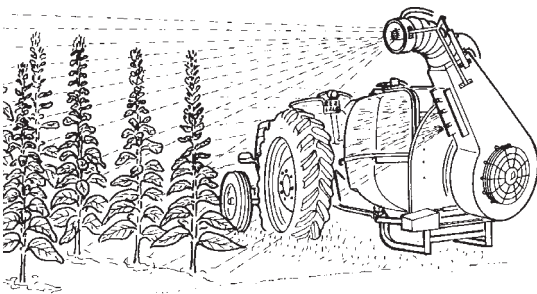

6.4.2 TREATMENTS ON HERBACEOUS CULTIVATIONS

- a) Use the tables of pages 31-33 choosing the one relevant to the type of cannon to use and the number of jets.
- b) Find the range and the diameter of the nozzles used (ceramic plate or TR nozzles).
- c) In the horizontal strip, choose the working speed and the distribution in litres/hectare and on the vertical scale find the pressure to use.
- d) Adjust the pressure to obtain the treatment required.

Note: the minimum range indicated in the table can vary significantly according to the adjustment of the single jets (screwed in more or less). To verify the exact delivery of the fan do tests with clean water.

7 HAND LANCES

When using hand lances bear in mind the following notes:

= Don't direct the jet of liquid towards electric power lines or zones where there is electrical current, houses or where people might pass.

= Don't point the jet at people or animals.

The jet can cause serious injuries simply due to the mechanical force of the liquid under pressure.

= Never block the spraying lever of the lance in an open position because if the lance falls it will be uncontrollable.

= At the end of work after you have stopped the pump, make sure that any residual pressure in the pipes under pressure has been drained to avoid unexpected jets when putting the lance away.

There are various types of lances; with a lever, mitra spray gun and pistol grip. For further information please refer to the handbook in the package.

The lever lance is controlled by opening lever A which, depending on how much it's pressed, produces a conical spray or direct jet. The standard nozzle is Ø 1.5

The mitra spray gun can produce a direct jet or a conical spray and the type of spray is selected by pushing lever B forwards or backwards. Use lever C to open the jet. The standard nozzle is Ø 2.5

Replacement nozzles are available for all of the lances and the capacities are indicated in the tables TAB.4 and TAB.5 (page 34).

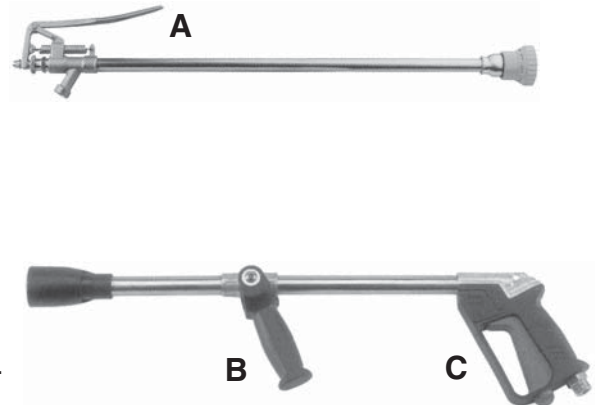



8 MAINTENANCE

All of the maintenance operations and repairs must be carried out with the machine and cardan shaft stopped and the tank and circuit clean of any residues of chemical products.

The maintenance of the atomiser is essential for maintaining a high level of safety. Also consult the single handbooks of the main components of the atomiser.

8.1 PROGRAMMED MAINTENANCE

(TAB. N° 7, page 36)

We recommend using a table of programmed maintenance to follow in time to keep the atomiser in an efficient working condition.

For major and important maintenance jobs we recommend using the normal UNIGREEN assistance service available from your reseller, (if necessary) replacing parts using original spare parts only.

8.2 ROUTINE MAINTENANCE

= After every treatment wash the inside of the tank and the entire circuit as indicated in paragraph 4.13

= Periodically check that the suction and delivery filters are clean

= Check the oil level in the volumetric compensator of the pump

= The use of chemical products that are particularly damaging for a nitrile rubber mix can cause the diaphragm to break before time.

In these conditions check the state of the components more often. There are diaphragms made of special materials (viton and desmopan) that are available on request.

= When doing treatments with copper hydroxide you should take great care to thoroughly clean the system, washing it after each treatment because hydroxides attack parts that aren't painted or protected by hot galvanising. To prevent chemical attacks we recommend spraying transparent paint on the parts that are most exposed to the product and equipping the atomiser with stainless steel pressure gauges.

8.2.1 CLEANING THE NOZZLES

Check the state of wear of the nozzles and replace them when the delivery is over 30-35% of the theoretical level.

If you notice even a partial blockage of a nozzle proceed as follows:

- drain the pressure and stop the machine
- dismantle the screw or bayonet ringnuts holding the nozzles
- clean with a small brush or compressed air, **don't use nails, punches or bradawls**
- reassemble the nozzles and the ringnuts, replacing the filters and seals.

8.2.2 LUBRICATION

The moving mechanical components must be lubricated to prevent wear and overheating. This lubrication can be done with grease or oil: oil allows significantly higher speeds, in general grease is used to lubricate bearings with a vertical or inclined axis as it stays in the zone for longer.

8.2.3 MULTIPLIER LUBRICATION

The multiplier and disengaging boxes are normally lubricated in an "oil bath", in special cases NLGI n.0 grease is used. The viscosity is an essential characteristic of a lubricant oil and this is indicated by the SAE (SOCIETY OF AUTO-MOTIVE ENGINEERS) classification of the oils for gearboxes and differentials. Special additives improve the capacity of the oil to maintain a lubricant film also at high pressures and temperatures. We recommended using SAE 90 oil for the multiplier and disengaging boxes. The quantity of oil is established by the level cap. A greater quantity of oil doesn't improve the conditions of lubrication and can cause overheating in the box. Changing the oil protects the parts from the dangers associated with wear and the presence of metallic particles that can be present, especially in the first period of use. We recommend replacing the oil after the first 50 working hours and then subsequently every 500 hours.

The quantity of oil needed is indicated on the sticker near the multiplier (FIG. 23)

WARNING: the oil used mustn't be dispersed in the environment and must be collected the relevant containers.

8.3 EXTRAORDINARY MAINTENANCE

At the end of a season of intense use, or every two years of normal use, it is a good idea to have a specialised service technician perform a general check on the machine.

8.4 REPAIRS



FIG. 29



We recommend having the normal UNIGREEN assistance service available from our reseller perform any repairs or contact a specialised workshop. During all of the repairs, in particular when welding, the machine and the circuit must be clean of any residues of chemical product. If the machine has to be lifted (for example to change a wheel) follow the instructions in point 4.3 of the present handbook.

Also make sure the machine is stopped, connected to the tractor, and use the relevant chocks to block the wheel still on the ground.

If you use a jack (manual or hydraulic) make sure you use a jack that is suitable for the frame so it can't slip and put it in the right position. The jack must be placed under the main frame of the machine near the wheel to change. Make sure the ground is compact: if necessary use wooden beams or other sufficiently resistant material to broaden the supporting base of the jack.



8.5 STORAGE IN A WAREHOUSE AND TRANSPORTATION

The sprayer must be kept in a closed place away from excessive humidity and protected from frost. Especially if electrical pressure regulators, electrical motors, a spraying computer or similar components are fitted.

Before storing the machine, after you have washed it, apply a light coat of oil.

If the temperature might drop to below zero, drain any residual liquid or add roughly 0.5 L of normal antifreeze for auto vehicles.

To transport the machine follow the instructions in point 4.3 of the present handbook.

8.6 PUTTING BACK INTO SERVICE AFTER WINTER LAYUP

Before using the machine again after a long period of inactivity you should perform some general checks, following the instructions in point 4.2 and drain any antifreeze.

Never start the shaft of the pump if you think there may be ice inside. To check this, make sure you can turn the shaft by hand without connecting it to the tractor.

After you have connected the machine to the tractor (see point 4.4) following the instructions in the present user's handbook and in the enclosures of the pump, pressure regulator and accessories.

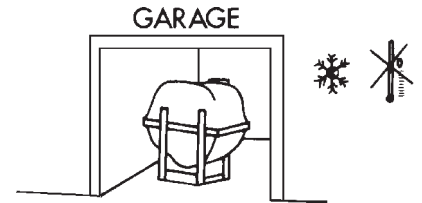

8.7 DEMOLITION AND DISPOSAL

When the sprayer will be put out of service you should wash it with great care to remove any residues of chemical product, follow the instructions in point 4.13 of the present handbook.

ATTENTION: It is necessary to adopt appropriate Individual Protection Devices in manipulating waste.

The disposal of waste deriving from the demolition of the machine must be carried out respecting the environment, avoiding soil, air and water pollution.

Local legislation in force in the matter must be respected in any case.

Remember that waste is understood as any substance or object that enters into the categories shown in attachment A in part IV of Legislative Decree 152/2006, that the holder has destroyed, has decided or is obliged to destroy.

Waste deriving from the demolition of the machine is classifiable as special waste.



8.7.1 MATERIALS FOR DEMOLITION

Non-dangerous special waste is that which can be recovered, according to the February 1998 Ministerial Decree:

- Iron, aluminium, stainless steel and copper materials
- Plastic materials
- Electronic cards
- Hydraulic oil
- Electrical plant



8.7.2 INDICATIONS FOR A SUITABLE TREATMENT OF WASTE

The Correct management of special waste envisages:

- stocking in suitable places, avoiding mixing dangerous waste with the non-dangerous.
- ensuring that authorised carriers and receivers carry out its transport and disposal/recovery.

Transport of one's waste to authorised collection centres is allowed exclusively if you are enrolled in the Environmental Management Register.



8.7.3 ELECTRICAL AND ELECTRONIC APPARATUS WASTE (EEAW)

The Italian government has adopted the European Parliament directives in the matter of the disposal of electrical and electronic waste (EEAW) (2002/95/CE and 2003/108/CE Directives) with Legislative Decree n° 151, July 25 2005).

The measures: in particular, the decree established measures and procedures aimed at:

- a) forestalling the production of EEAW;
- b) promoting the re-use, recycling and other forms of EEAW recovery, in order to reduce the quantity to send for disposal;
- c) improving, in terms of the environment, the actions of the subjects who participate in the life-cycle of these apparatuses (producers, distributors, consumers and operators directly involved in the treatment of EEAW);

d) reducing the use of dangerous substances in electrical and electronic apparatus.











The decree imposes the limitation and elimination of several substances present in EAW: lead, mercury, cadmium, chrome, hexavalent chrome, polybrominated biphenyl, polybrominated diphenyl and polybrominated diphenyl ethers.

The machine has been designed and created in conformity with this directive. Follow the indications shown below.

The symbol to the side, showing a barred garbage can on wheels, indicates the separate collection of the electrical and electronic apparatuses of the machine.

The user of the present machine can contact the collection centres instituted by the Local Authorities or the UNIGREEN Company directly, or request withdrawal by the dealer, in order to carry out correct disposal of the waste.

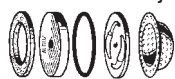
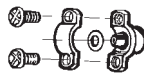
Commonly used spare parts

part	description			code
	single Ø18 non-drip jet for atomiser with diaphragm (1/4" mount) without nozzles			1224/0194F
	double Ø18 non-drip jet for atomiser with diaphragm (1/4" mount) without nozzles			1224/0195F
	double 15 + Ø18 non-drip jet Ø for cannon with diaphragm (1/4" mount) without nozzles			1224/0199F
	ceramic conical nozzle high volume for Ø18 atomiser jet	Ø0,8 Ø1,0 Ø1,2 Ø1,5 Ø1,8 Ø2,0		3400/0394F 3400/0395F 3400/0396F 3400/0397F 3400/0398F 3400/0399F
	diffuser Ø18 mm. for atomiser jet	closed Ø1,0 Ø1,2 Ø1,5 Ø1,8		B1606.0011 B1606.0012 B1606.0013 B1606.0014 B1606.0015
	filter for Ø18 jet	holes Ø 0,8		1002/0110F
Ceramic, conical nozzle kit, filter diffuser and seal for Ø18 mm jet 	Nozzle Ø0,8 Nozzle Ø1,0 Nozzle Ø1,2 Nozzle Ø1,5 Nozzle Ø1,8 Nozzle Ø2,0	Dif. Ø1,0 Dif. Ø1,0 Dif. Ø1,2 Dif. Ø1,5 Dif. Ø1,8 Dif. Ø1,8	Filter Ø0,8 Filter Ø0,8 Filter Ø1,0 Filter Ø1,0 Filter Ø1,0 Filter Ø1,0	3400/0400F 3400/0401F 3400/0402F 3400/0403F 3400/0404F 3400/0405F
	Clamp kit for fixing G1/4" jets on Ø1/2" booms			1805/0034F
	Clamp kit for fixing G1/4" jets on Ø1/2" booms+ M8 F thread			1805/0050F
Teejet 	ISO nozzle ceramic conical with slinger + OR	TXA80-005 TXA80-067 TXA80-01 TXA80-015 TXA80-02 TXA80-03 TXA80-04 TXA80-05	Lilac Olive Orange Green Yellow Blue Red Brown	3400/0611F 3400/0612F 3400/0613F 3400/0614F 3400/0615F 3400/0616F 3400/0617F /

TABLES FOR CALIBRATING ATOMISERS

TABLES FOR CALIBRATING ATOMISERS Ø500-600

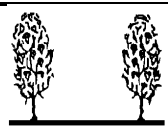
unigreen spa		Tabella erogazione in Litri/ettaro Gr.Ventola Ø500-Ø600 8 getti													Larghezza di lavoro working width		
Lt./ha spreading rate table for Blower Ø500-Ø600 8 NOZZLES																	
		Piastrina ceramica Ø1,0							Piastrina ceramica Ø1,2								
PRESSIONE bar		10	15	20	25	30	40	50	10	15	20	25	30	40	50		
Velocità Km/h speed	3,5	857	983	1120	1246	1354	1543	1691	1154	1417	1623	1806	1989	2286	2514	Litri/ha	 3 m.
	4	750	860	980	1090	1185	1350	1480	1010	1240	1420	1580	1740	2000	2200		
	5	600	688	784	872	948	1080	1184	808	992	1136	1264	1392	1600	1760		
	6	500	573	653	727	790	900	987	673	827	947	1053	1160	1333	1467		
	7	429	491	560	623	677	771	846	577	709	811	903	994	1143	1257		
Velocità Km/h speed	3,5	643	737	840	934	1016	1157	1269	866	1063	1217	1354	1491	1714	1886	Litri/ha	 4 m.
	4	563	645	735	818	889	1013	1110	758	930	1065	1185	1305	1500	1650		
	5	450	516	588	654	711	810	888	606	744	852	948	1044	1200	1320		
	6	375	430	490	545	593	675	740	505	620	710	790	870	1000	1100		
	7	321	369	420	467	508	579	634	433	531	609	677	746	857	943		
Velocità Km/h speed	3,5	514	590	672	747	813	926	1015	693	850	974	1083	1193	1371	1509	Litri/ha	 5 m.
	4	450	516	588	654	711	810	888	606	744	852	948	1044	1200	1320		
	5	360	413	470	523	569	648	710	485	595	682	758	835	960	1056		
	6	300	344	392	436	474	540	592	404	496	568	632	696	800	880		
	7	257	295	336	374	406	463	507	346	425	487	542	597	686	754		

Litri/min.	15,0	17,2	19,6	21,8	23,7	27,0	29,6	20,2	24,8	28,4	31,6	34,8	40,0	44,0
ug. sing.	1,88	2,15	2,45	2,72	2,96	3,37	3,70	2,53	3,10	3,55	3,95	4,35	5,00	5,50

Tab. 3215/0000F

N.B. to calculate the different ranges it is sufficient to multiply the value lt/hectare by the corresponding width indicated in the table and divide it by the new width (see chapter 6.3, page 20).

unigreen spa		Tabella erogazione in Litri/ettaro Gr.Ventola Ø500-Ø600 8 getti													Larghezza di lavoro working width		
Lt./ha spreading rate table for Blower Ø500-Ø600 8 NOZZLES																	
		TR80-01 ARANCIO							TR80-015 VERDE								
PRESSIONE bar		5	7	10	12	15	18	20	5	7	10	12	15	18	20		
Velocità Km/h speed	3,5	234	274	331	354	400	440	463	34	411	491	537	600	657	697	Litri/ha	 3 m.
	4	205	240	290	310	350	385	405	30	360	430	470	525	575	610		
	5	164	192	232	248	280	308	324	24	288	344	376	420	460	488		
	6	137	160	193	207	233	257	270	20	240	287	313	350	383	407		
	7	117	137	166	177	200	220	231	17	206	246	269	300	329	349		
Velocità Km/h speed	3,5	176	206	249	266	300	330	347	26	309	369	403	450	493	523	Litri/ha	 4 m.
	4	154	180	218	233	263	289	304	23	270	323	353	394	431	458		
	5	123	144	174	186	210	231	243	18	216	258	282	315	345	366		
	6	103	120	145	155	175	193	203	15	180	215	235	263	288	305		
	7	88	103	124	133	150	165	174	13	154	184	201	225	246	261		
Velocità Km/h speed	3,5	141	165	199	213	240	264	278	21	247	295	322	360	394	418	Litri/ha	 5 m.
	4	123	144	174	186	210	231	243	18	216	258	282	315	345	366		
	5	98	115	139	149	168	185	194	14	173	206	226	252	276	293		
	6	82	96	116	124	140	154	162	12	144	172	188	210	230	244		
	7	70	82	99	106	120	132	139	10	123	147	161	180	197	209		

Litri/min.	4,1	4,8	5,8	6,2	7,0	7,7	8,1	0,6	7,2	8,6	9,4	10,5	11,5	12,2
ug. sing.	0,51	0,60	0,72	0,78	0,88	0,96	1,01	0,08	0,90	1,07	1,18	1,31	1,44	1,52

Tab. 3215/0000F

TABLES FOR CALIBRATING ATOMISERS



TABLES FOR CALIBRATING ATOMISERS Ø600-650

unigreen spa		Tabella erogazione in Litri/ettaro Gr.Ventola Ø600-Ø650 10 getti													Larghezza di lavoro working width		
		Piastrina ceramica Ø1,0							Piastrina ceramica Ø1,2								
PRESSIONE bar		10	15	20	25	30	40	50	10	15	20	25	30	40	50		
Velocità Km/h speed	3,5	1074	1229	1400	1554	1691	1926	2114	1446	1771	2029	2257	2486	2857	3143	Litri/ha	
	4	940	1075	1225	1360	1480	1685	1850	1265	1550	1775	1975	2175	2500	2750		
	5	752	860	980	1088	1184	1348	1480	1012	1240	1420	1580	1740	2000	2200		
	6	627	717	817	907	987	1123	1233	843	1033	1183	1317	1450	1667	1833		
	7	537	614	700	777	846	963	1057	723	886	1014	1129	1243	1429	1571		
Velocità Km/h speed	3,5	806	921	1050	1166	1269	1444	1586	1084	1329	1521	1693	1864	2143	2357	Litri/ha	
	4	705	806	919	1020	1110	1264	1388	949	1163	1331	1481	1631	1875	2063		
	5	564	645	735	816	888	1011	1110	759	930	1065	1185	1305	1500	1650		
	6	470	538	613	680	740	843	925	633	775	888	988	1088	1250	1375		
	7	403	461	525	583	634	722	793	542	664	761	846	932	1071	1179		
Velocità Km/h speed	3,5	645	737	840	933	1015	1155	1269	867	1063	1217	1354	1491	1714	1886	Litri/ha	
	4	564	645	735	816	888	1011	1110	759	930	1065	1185	1305	1500	1650		
	5	451	516	588	653	710	809	888	607	744	852	948	1044	1200	1320		
	6	376	430	490	544	592	674	740	506	620	710	790	870	1000	1100		
	7	322	369	420	466	507	578	634	434	531	609	677	746	857	943		

Litri/min.	18,8	21,5	24,5	27,2	29,6	33,7	37,0	25,3	31,0	35,5	39,5	43,5	50,0	55,0
ug. sing.	1,88	2,15	2,45	2,72	2,96	3,37	3,70	2,53	3,10	3,55	3,95	4,35	5,00	5,50

Tab. 3215/0000F

N.B. to calculate the different ranges it is sufficient to multiply the value lt/hectare by the corresponding width indicated in the table and divide it by the new width (see chapter 6.3, page 20).



unigreen spa		Tabella erogazione in Litri/ettaro Gr.Ventola Ø600-Ø650 10 getti													Larghezza di lavoro working width		
		TR80-01 ARANCIO							TR80-015 VERDE								
PRESSIONE bar		5	7	10	12	15	18	20	5	7	10	12	15	18	20		
Velocità Km/h speed	3,5	291	343	411	446	503	549	577	46	514	611	674	749	823	869	Litri/ha	
	4	255	300	360	390	440	480	505	40	450	535	590	655	720	760		
	5	204	240	288	312	352	384	404	32	360	428	472	524	576	608		
	6	170	200	240	260	293	320	337	27	300	357	393	437	480	507		
	7	146	171	206	223	251	274	289	23	257	306	337	374	411	434		
Velocità Km/h speed	3,5	219	257	309	334	377	411	433	34	386	459	506	561	617	651	Litri/ha	
	4	191	225	270	293	330	360	379	30	338	401	443	491	540	570		
	5	153	180	216	234	264	288	303	24	270	321	354	393	432	456		
	6	128	150	180	195	220	240	253	20	225	268	295	328	360	380		
	7	109	129	154	167	189	206	216	17	193	229	253	281	309	326		
Velocità Km/h speed	3,5	175	206	247	267	302	329	346	27	309	367	405	449	494	521	Litri/ha	
	4	153	180	216	234	264	288	303	24	270	321	354	393	432	456		
	5	122	144	173	187	211	230	242	19	216	257	283	314	346	365		
	6	102	120	144	156	176	192	202	16	180	214	236	262	288	304		
	7	87	103	123	134	151	165	173	14	154	183	202	225	247	261		

Litri/min.	5,1	6,0	7,2	7,8	8,8	9,6	10,1	0,8	9,0	10,7	11,8	13,1	14,4	15,2
ug. sing.	0,51	0,60	0,72	0,78	0,88	0,96	1,01	0,08	0,90	1,07	1,18	1,31	1,44	1,52

Tab. 3215/0000F

TABLES FOR CALIBRATING ATOMISERS

TABLES FOR CALIBRATING ATOMISERS Ø700-750

unigreen spa		Tabella erogazione in Litri/ettaro Gr.Ventola Ø700-Ø750 12 getti															
		Lt./ha spreading rate table for Blower Ø700-Ø750 12 NOZZLES															
		Piastrina ceramica Ø1,0							Piastrina ceramica Ø1,2							Larghezza di lavoro working width	
PRESSIONE bar		10	15	20	25	30	40	50	10	15	20	25	30	40	50		
Velocità Km/h speed	3,5	1291	1474	1680	1863	2029	2309	2537	1737	2126	2434	2709	2983	3429	3771	Litri/ha  	3 m.
	4	1130	1290	1470	1630	1775	2020	2220	1520	1860	2130	2370	2610	3000	3300		
	5	904	1032	1176	1304	1420	1616	1776	1216	1488	1704	1896	2088	2400	2640		
	6	753	860	980	1087	1183	1347	1480	1013	1240	1420	1580	1740	2000	2200		
	7	646	737	840	931	1014	1154	1269	869	1063	1217	1354	1491	1714	1886		
Velocità Km/h speed	3,5	969	1106	1260	1397	1521	1731	1903	1303	1594	1826	2031	2237	2571	2829	Litri/ha  	4 m.
	4	848	968	1103	1223	1331	1515	1665	1140	1395	1598	1778	1958	2250	2475		
	5	678	774	882	978	1065	1212	1332	912	1116	1278	1422	1566	1800	1980		
	6	565	645	735	815	888	1010	1110	760	930	1065	1185	1305	1500	1650		
	7	484	553	630	699	761	866	951	651	797	913	1016	1119	1286	1414		
Velocità Km/h speed	3,5	775	885	1008	1118	1217	1385	1522	1042	1275	1461	1625	1790	2057	2263	Litri/ha  	5 m.
	4	678	774	882	978	1065	1212	1332	912	1116	1278	1422	1566	1800	1980		
	5	542	619	706	782	852	970	1066	730	893	1022	1138	1253	1440	1584		
	6	452	516	588	652	710	808	888	608	744	852	948	1044	1200	1320		
	7	387	442	504	559	609	693	761	521	638	730	813	895	1029	1131		

Litri/min.	22,6	25,8	29,4	32,6	35,5	40,4	44,4	30,4	37,2	42,6	47,4	52,2	60,0	66,0
ug. sing.	1,88	2,15	2,45	2,72	2,96	3,37	3,70	2,53	3,10	3,55	3,95	4,35	5,00	5,50

Tab. 3215/0000F

N.B. to calculate the different ranges it is sufficient to multiply the value lt/hectare by the corresponding width indicated in the table and divide it by the new width (see chapter 6.3, page 20).

unigreen spa		Tabella erogazione in Litri/ettaro Gr.Ventola Ø700-Ø750 12 getti														 	
		TR80-01 ARANCIO							TR80-015 VERDE							Larghezza di lavoro working width	
PRESSIONE bar		5	7	10	12	15	18	20	5	7	10	12	15	18	20		
Velocità Km/h speed	3,5	349	411	491	537	606	657	691	51	617	731	811	897	989	1040	Litri/ha  	3 m.
	4	305	360	430	470	530	575	605	45	540	640	710	785	865	910		
	5	244	288	344	376	424	460	484	36	432	512	568	628	692	728		
	6	203	240	287	313	353	383	403	30	360	427	473	523	577	607		
	7	174	206	246	269	303	329	346	26	309	366	406	449	494	520		
Velocità Km/h speed	3,5	261	309	369	403	454	493	519	39	463	549	609	673	741	780	Litri/ha  	4 m.
	4	229	270	323	353	398	431	454	34	405	480	533	589	649	683		
	5	183	216	258	282	318	345	363	27	324	384	426	471	519	546		
	6	153	180	215	235	265	288	303	23	270	320	355	393	433	455		
	7	131	154	184	201	227	246	259	19	231	274	304	336	371	390		
Velocità Km/h speed	3,5	209	247	295	322	363	394	415	31	370	439	487	538	593	624	Litri/ha  	5 m.
	4	183	216	258	282	318	345	363	27	324	384	426	471	519	546		
	5	146	173	206	226	254	276	290	22	259	307	341	377	415	437		
	6	122	144	172	188	212	230	242	18	216	256	284	314	346	364		
	7	105	123	147	161	182	197	207	15	185	219	243	269	297	312		

Litri/min.	6,1	7,2	8,6	9,4	10,6	11,5	12,1	0,9	10,8	12,8	14,2	15,7	17,3	18,2
ug. sing.	0,51	0,60	0,72	0,78	0,88	0,96	1,01	0,08	0,90	1,07	1,18	1,31	1,44	1,52

Tab. 3215/0000F

TABLES FOR CALIBRATING ATOMISERS

TABLES FOR CALIBRATING ATOMISERS Ø800

unigreen spa		Tabella erogazione in Litri/ettaro Gr.Ventola Ø800 14 getti															
		<i>Lt./ha spreading rate table for Blower Ø800 14 NOZZLES</i>															
		Piastrina ceramica Ø1,0							Piastrina ceramica Ø1,2							Larghezza di lavoro <i>working width</i>	
PRESSIONE bar		10	15	20	25	30	40	50	10	15	20	25	30	40	50		
Velocità Km/h <i>speed</i>	3,5	1127	1290	1470	1633	1774	2023	2220	1517	1860	2130	2370	2610	3000	3300	Litri/ha	 4
	4	986	1129	1286	1429	1553	1770	1943	1328	1628	1864	2074	2284	2625	2888		
	5	789	903	1029	1143	1242	1416	1554	1062	1302	1491	1659	1827	2100	2310		
	6	658	753	858	953	1035	1180	1295	885	1085	1243	1383	1523	1750	1925		
	7	564	645	735	816	887	1011	1110	759	930	1065	1185	1305	1500	1650		
Velocità Km/h <i>speed</i>	3,5	902	1032	1176	1306	1419	1618	1776	1214	1488	1704	1896	2088	2400	2640	Litri/ha	 5 m.
	4	789	903	1029	1143	1242	1416	1554	1062	1302	1491	1659	1827	2100	2310		
	5	631	722	823	914	994	1133	1243	850	1042	1193	1327	1462	1680	1848		
	6	526	602	686	762	828	944	1036	708	868	994	1106	1218	1400	1540		
	7	451	516	588	653	710	809	888	607	744	852	948	1044	1200	1320		
Velocità Km/h <i>speed</i>	3,5	751	860	980	1089	1183	1349	1480	1011	1240	1420	1580	1740	2000	2200	Litri/ha	 6 m.
	4	658	753	858	953	1035	1180	1295	885	1085	1243	1383	1523	1750	1925		
	5	526	602	686	762	828	944	1036	708	868	994	1106	1218	1400	1540		
	6	438	502	572	635	690	787	863	590	723	828	922	1015	1167	1283		
	7	376	430	490	544	591	674	740	506	620	710	790	870	1000	1100		

Litri/min.	26,3	30,1	34,3	38,1	41,4	47,2	51,8	35,4	43,4	49,7	55,3	60,9	70,0	77,0
ug. sing.	1,88	2,15	2,45	2,72	2,96	3,37	3,70	2,53	3,10	3,55	3,95	4,35	5,00	5,50

Tab. 3215/0000F

N.B. to calculate the different ranges it is sufficient to multiply the value lt/hectare by the corresponding width indicated in the table and divide it by the new width (see chapter 6.3, page 20).



unigreen spa		Tabella erogazione in Litri/ettaro Gr.Ventola Ø800 14 getti															
		<i>Lt./ha spreading rate table for Blower Ø800 14NOZZLES</i>															
		TR80-01 ARANCIO							TR80-015 VERDE							Larghezza di lavoro <i>working width</i>	
PRESSIONE bar		5	7	10	12	15	18	20	5	7	10	12	15	18	20		
Velocità Km/h <i>speed</i>	3,5	304	360	433	467	527	574	604	47	540	643	707	784	866	913	Litri/ha	 4 m.
	4	266	315	379	409	461	503	529	41	473	563	619	686	758	799		
	5	213	252	303	327	369	402	423	33	378	450	495	549	606	639		
	6	178	210	253	273	308	335	353	28	315	375	413	458	505	533		
	7	152	180	216	234	264	287	302	24	270	321	354	392	433	456		
Velocità Km/h <i>speed</i>	3,5	243	288	346	374	422	459	483	38	432	514	566	627	693	730	Litri/ha	 5 m.
	4	213	252	303	327	369	402	423	33	378	450	495	549	606	639		
	5	170	202	242	262	295	322	338	26	302	360	396	439	485	511		
	6	142	168	202	218	246	268	282	22	252	300	330	366	404	426		
	7	122	144	173	187	211	230	242	19	216	257	283	314	346	365		
Velocità Km/h <i>speed</i>	3,5	203	240	289	311	351	383	403	31	360	429	471	523	577	609	Litri/ha	 6 m.
	4	178	210	253	273	308	335	353	28	315	375	413	458	505	533		
	5	142	168	202	218	246	268	282	22	252	300	330	366	404	426		
	6	118	140	168	182	205	223	235	18	210	250	275	305	337	355		
	7	101	120	144	156	176	191	201	16	180	214	236	261	289	304		

Litri/min.	7,1	8,4	10,1	10,9	12,3	13,4	14,1	1,1	12,6	15,0	16,5	18,3	20,2	21,3
ug. sing.	0,51	0,60	0,72	0,78	0,88	0,96	1,01	0,08	0,90	1,07	1,18	1,31	1,44	1,52

Tab. 3215/0000F

TABLES FOR CALIBRATING ATOMISERS

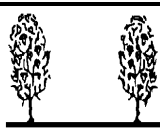
TABLES FOR CALIBRATING ATOMISERS Ø900

unigreen spa		Tabella erogazione in Litri/ettaro Gr.Ventola Ø900 16 getti														Larghezza di lavoro working width	
		Piastrina ceramica Ø1,0							Piastrina ceramica Ø1,2								
PRESSIONE bar		10	15	20	25	30	40	50	10	15	20	25	30	40	50		
Velocità Km/h speed	3,5	1290	1474	1680	1864	2031	2310	2537	1736	2126	2434	2709	2983	3429	3771	Litri/ha	
	4	1129	1290	1470	1631	1778	2021	2220	1519	1860	2130	2370	2610	3000	3300		
	5	903	1032	1176	1305	1422	1617	1776	1215	1488	1704	1896	2088	2400	2640		
	6	753	860	980	1088	1185	1348	1480	1013	1240	1420	1580	1740	2000	2200		
	7	645	737	840	932	1016	1155	1269	868	1063	1217	1354	1491	1714	1886		
Velocità Km/h speed	3,5	1032	1179	1344	1491	1625	1848	2030	1389	1701	1947	2167	2386	2743	3017	Litri/ha	
	4	903	1032	1176	1305	1422	1617	1776	1215	1488	1704	1896	2088	2400	2640		
	5	722	826	941	1044	1138	1294	1421	972	1190	1363	1517	1670	1920	2112		
	6	602	688	784	870	948	1078	1184	810	992	1136	1264	1392	1600	1760		
	7	516	590	672	746	813	924	1015	694	850	974	1083	1193	1371	1509		
Velocità Km/h speed	3,5	860	983	1120	1243	1354	1540	1691	1157	1417	1623	1806	1989	2286	2514	Litri/ha	
	4	753	860	980	1088	1185	1348	1480	1013	1240	1420	1580	1740	2000	2200		
	5	602	688	784	870	948	1078	1184	810	992	1136	1264	1392	1600	1760		
	6	502	573	653	725	790	898	987	675	827	947	1053	1160	1333	1467		
	7	430	491	560	621	677	770	846	579	709	811	903	994	1143	1257		

Litri/min.	30,1	34,4	39,2	43,5	47,4	53,9	59,2	40,5	49,6	56,8	63,2	69,6	80,0	88,0
ug. sing.	1,88	2,15	2,45	2,72	2,96	3,37	3,70	2,53	3,10	3,55	3,95	4,35	5,00	5,50

Tab. 3215/0000F

N.B. to calculate the different ranges it is sufficient to multiply the value lt/hectare by the corresponding width indicated in the table and divide it by the new width (see chapter 6.3, page 20).

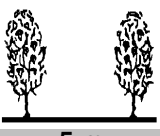
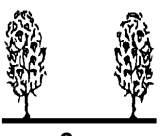
unigreen spa		Tabella erogazione in Litri/ettaro Gr.Ventola Ø900 16 getti														Larghezza di lavoro working width	
		TR80-01 ARANCIO							TR80-015 VERDE								
PRESSIONE bar		5	7	10	12	15	18	20	5	7	10	12	15	18	20		
Velocità Km/h speed	3,5	351	411	493	536	604	660	694	51	617	733	810	900	986	1041	Litri/ha	
	4	308	360	431	469	529	578	608	45	540	641	709	788	863	911		
	5	246	288	345	375	423	462	486	36	432	513	567	630	690	729		
	6	205	240	288	313	353	385	405	30	360	428	473	525	575	608		
	7	176	206	246	268	302	330	347	26	309	366	405	450	493	521		
Velocità Km/h speed	3,5	281	329	394	429	483	528	555	41	494	586	648	720	789	833	Litri/ha	
	4	246	288	345	375	423	462	486	36	432	513	567	630	690	729		
	5	197	230	276	300	338	370	389	29	346	410	454	504	552	583		
	6	164	192	230	250	282	308	324	24	288	342	378	420	460	486		
	7	141	165	197	214	242	264	278	21	247	293	324	360	394	417		
Velocità Km/h speed	3,5	234	274	329	357	403	440	463	34	411	489	540	600	657	694	Litri/ha	
	4	205	240	288	313	353	385	405	30	360	428	473	525	575	608		
	5	164	192	230	250	282	308	324	24	288	342	378	420	460	486		
	6	137	160	192	208	235	257	270	20	240	285	315	350	383	405		
	7	117	137	164	179	201	220	231	17	206	244	270	300	329	347		

Litri/min.	8,2	9,6	11,5	12,5	14,1	15,4	16,2	1,2	14,4	17,1	18,9	21,0	23,0	24,3
ug. sing.	0,51	0,60	0,72	0,78	0,88	0,96	1,01	0,08	0,90	1,07	1,18	1,31	1,44	1,52

Tab. 3215/0000F

TABLES FOR CALIBRATING ATOMISERS

TABLES FOR CALIBRATING ATOMISERS Ø650TGZ

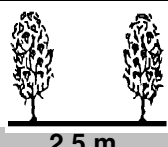
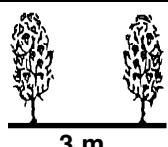
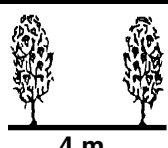
unigreen spa		Tabella erogazione in Litri/ettaro Gr.Ventola Ø650 14 getti													14 GETTI	ISO	
		TR 80-01 ISO VERDE						TR 80-03 ISO BLU						Larghezza di lavoro working width			
PRESSIONE bar		5	7	10	12	15	18	20	5	7	10	12	15	18	20		
Velocità Km/h speed	3,5	727	864	1029	1131	1255	1385	1461	1467	1735	2085	2283	2551	2791	2949	Litri/ha	 2,5 m.
	4	636	756	900	990	1098	1212	1278	1284	1518	1824	1998	2232	2442	2580		
	5	509	605	720	792	878	970	1022	1027	1214	1459	1598	1786	1954	2064		
	6	424	504	600	660	732	808	852	856	1012	1216	1332	1488	1628	1720		
	7	363	432	514	566	627	693	730	734	867	1042	1142	1275	1395	1474		
Velocità Km/h speed	3,5	606	720	857	943	1046	1154	1217	1223	1446	1737	1903	2126	2326	2457	Litri/ha	 3 m.
	4	530	630	750	825	915	1010	1065	1070	1265	1520	1665	1860	2035	2150		
	5	424	504	600	660	732	808	852	856	1012	1216	1332	1488	1628	1720		
	6	353	420	500	550	610	673	710	713	843	1013	1110	1240	1357	1433		
	7	303	360	429	471	523	577	609	611	723	869	951	1063	1163	1229		
Velocità Km/h speed	3,5	454	540	643	707	784	866	913	917	1084	1303	1427	1594	1744	1843	Litri/ha	 4 m.
	4	398	473	563	619	686	758	799	803	949	1140	1249	1395	1526	1613		
	5	318	378	450	495	549	606	639	642	759	912	999	1116	1221	1290		
	6	265	315	375	413	458	505	533	535	633	760	833	930	1018	1075		
	7	227	270	321	354	392	433	456	459	542	651	714	797	872	921		
Litri/min.		10,6	12,6	15,0	16,5	18,3	20,2	21,3	21,4	25,3	30,4	33,3	37,2	40,7	43,0	Tab. 3215/0000F	
ug. sing.		0,76	0,9	1,07	1,18	1,31	1,44	1,52	1,53	1,81	2,17	2,38	2,66	2,91	3,07		

N.B. to calculate the different ranges it is sufficient to multiply the value lt/hectare by the corresponding width indicated in the table and divide it by the new width (see chapter 6.3, page 20).

TABLES FOR CALIBRATING ATOMISERS Ø800TGZ

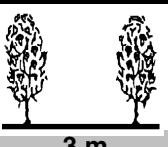
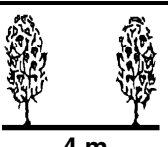
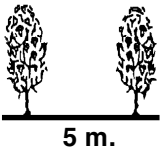
unigreen spa		Tabella erogazione in Litri/ettaro Gr.Ventola Ø800 16 getti													16 GETTI	ISO	
		TR 80-01 ISO VERDE						TR 80-03 ISO BLU						Larghezza di lavoro working width			
PRESSIONE bar		5	7	10	12	15	18	20	5	7	10	12	15	18	20		
Velocità Km/h speed	3,5	697	823	977	1080	1200	1314	1389	1400	1657	1983	2177	2434	2663	2806	Litri/ha	 3 m.
	4	610	720	855	945	1050	1150	1215	1225	1450	1735	1905	2130	2330	2455		
	5	488	576	684	756	840	920	972	980	1160	1388	1524	1704	1864	1964		
	6	407	480	570	630	700	767	810	817	967	1157	1270	1420	1553	1637		
	7	349	411	489	540	600	657	694	700	829	991	1089	1217	1331	1403		
Velocità Km/h speed	3,5	523	617	733	810	900	986	1041	1050	1243	1487	1633	1826	1997	2104	Litri/ha	 4 m.
	4	458	540	641	709	788	863	911	919	1088	1301	1429	1598	1748	1841		
	5	366	432	513	567	630	690	729	735	870	1041	1143	1278	1398	1473		
	6	305	360	428	473	525	575	608	613	725	868	953	1065	1165	1228		
	7	261	309	366	405	450	493	521	525	621	744	816	913	999	1052		
Velocità Km/h speed	3,5	418	494	586	648	720	789	833	840	994	1190	1306	1461	1598	1683	Litri/ha	 5 m.
	4	366	432	513	567	630	690	729	735	870	1041	1143	1278	1398	1473		
	5	293	346	410	454	504	552	583	588	696	833	914	1022	1118	1178		
	6	244	288	342	378	420	460	486	490	580	694	762	852	932	982		
	7	209	247	293	324	360	394	417	420	497	595	653	730	799	842		
Litri/min.		12,2	14,4	17,1	18,9	21,0	23,0	24,3	24,5	29,0	34,7	38,1	42,6	46,6	49,1	Tab. 3215/0000F	
ug. sing.		0,76	0,9	1,07	1,18	1,31	1,44	1,52	1,53	1,81	2,17	2,38	2,66	2,91	3,07		

TABLES FOR CALIBRATING CANNONS

TABLES FOR CALIBRATING CANNONS Ø450

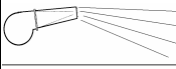
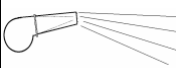
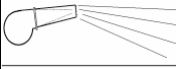
		Tabella erogazione in Litri/ettaro Cannone Ø450 2 getti														unigreen spa	
		Lt./ha spreading rate table for Cannone Blower Ø450 2 NOZZLES															
		Piastrina ceramica Ø1,5							Piastrina ceramica Ø1,8							Gittata spray distance	
PRESSIONE bar		10	15	20	25	30	40	50	10	15	20	25	30	40	50		
Velocità Km/h speed	3,5	528	651	747	831	915	1063	1203	883	1077	1248	1399	1522	1755	1975	Litri/ha	
	4	462	570	654	728	801	930	1053	773	942	1092	1224	1332	1536	1728		
	5	370	456	523	582	641	744	842	618	754	874	979	1066	1229	1382		
	6	308	380	436	485	534	620	702	515	628	728	816	888	1024	1152		
	7	264	326	374	416	458	531	602	441	538	624	699	761	878	987		
Velocità Km/h speed	3,5	352	434	498	554	610	709	802	589	718	832	933	1015	1170	1317	Litri/ha	
	4	308	380	436	485	534	620	702	515	628	728	816	888	1024	1152		
	5	246	304	349	388	427	496	562	412	502	582	653	710	819	922		
	6	205	253	291	323	356	413	468	343	419	485	544	592	683	768		
	7	176	217	249	277	305	354	401	294	359	416	466	507	585	658		
Velocità Km/h speed	3,5	293	362	415	462	509	590	669	490	598	693	777	846	975	1097	Litri/ha	
	4	257	317	363	404	445	517	585	429	523	607	680	740	853	960		
	5	205	253	291	323	356	413	468	343	419	485	544	592	683	768		
	6	171	211	242	269	297	344	390	286	349	404	453	493	569	640		
	7	147	181	208	231	254	295	334	245	299	347	389	423	488	549		
Litri/min.		31	38	44	49	53	62	70	52	63	73	82	89	102	115	Tab. 3215/0000F	
ug. sing.		3,85	4,75	5,45	6,06	6,67	7,75	8,78	6,44	7,85	9,10	10,20	11,10	12,80	14,40		

N.B. to obtain better agitation in the tank, verify that the total lt/min. spray delivery does not exceed 75% of the pump delivery. For example, with an APS 71 select a maximum setting of 50 lt/min.

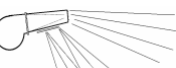
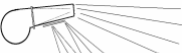
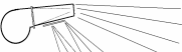

N.B. to calculate the different ranges extension it is sufficient to multiply the value lt/hectare by the corresponding width indicated in the table and divide it by the new width (see chapter 6.3, page 20).

		Tabella erogazione in Litri/ettaro Cannone Ø450 2 getti+2 laterali														unigreen spa	
		Lt./ha spreading rate table for Cannone Blower Ø450 2 NOZZLES+ 2 side nozzles															
		Piastrina ceramica Ø1,5							Piastrina ceramica Ø1,8							Gittata spray distance	
PRESSIONE bar		10	15	20	25	30	40	50	10	15	20	25	30	40	50		
Velocità Km/h speed	3,5	528	651	747	831	915	1063	1203	883	1077	1248	1399	1522	1755	1975	Litri/ha	
	4	462	570	654	728	801	930	1053	773	942	1092	1224	1332	1536	1728		
	5	370	456	523	582	641	744	842	618	754	874	979	1066	1229	1382		
	6	308	380	436	485	534	620	702	515	628	728	816	888	1024	1152		
	7	264	326	374	416	458	531	602	441	538	624	699	761	878	987		
Velocità Km/h speed	3,5	352	434	498	554	610	709	802	589	718	832	933	1015	1170	1317	Litri/ha	
	4	308	380	436	485	534	620	702	515	628	728	816	888	1024	1152		
	5	246	304	349	388	427	496	562	412	502	582	653	710	819	922		
	6	205	253	291	323	356	413	468	343	419	485	544	592	683	768		
	7	176	217	249	277	305	354	401	294	359	416	466	507	585	658		
Velocità Km/h speed	3,5	293	362	415	462	509	590	669	490	598	693	777	846	975	1097	Litri/ha	
	4	257	317	363	404	445	517	585	429	523	607	680	740	853	960		
	5	205	253	291	323	356	413	468	343	419	485	544	592	683	768		
	6	171	211	242	269	297	344	390	286	349	404	453	493	569	640		
	7	147	181	208	231	254	295	334	245	299	347	389	423	488	549		
Litri/min.		31	38	44	49	53	62	70	52	63	73	82	89	102	115	Tab. 3215/0000F	
ug. sing.		3,85	4,75	5,45	6,06	6,67	7,75	8,78	6,44	7,85	9,10	10,20	11,10	12,80	14,40		

N.B. to obtain better agitation in the tank, verify that the total lt/min. spray delivery does not exceed 75% of the pump delivery. For example, with an APS 71 select a maximum setting of 50 lt/min.

TABLES FOR CALIBRATING CANNONS

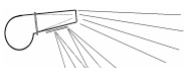
TABLES FOR CALIBRATING CANNONS Ø400-455

		Tabella erogazione in Litri/ettaro Cannone Ø400 6 getti + 2 laterali														unigreen spa
		Lt./ha spreading rate table for Cannone Blower Ø400 6 NOZZLES + 2 side nozzles														
		Piastrina ceramica Ø1,5							Piastrina ceramica Ø1,8							Gittata
PRESSIONE bar		10	15	20	25	30	40	50	10	15	20	25	30	40	50	spray distance
Velocità Km/h speed	3,5	352	434	498	554	610	709	802	589	718	832	933	1015	1170	1317	Litri/ha 
	4	308	380	436	485	534	620	702	515	628	728	816	888	1024	1152	
	5	246	304	349	388	427	496	562	412	502	582	653	710	819	922	
	6	205	253	291	323	356	413	468	343	419	485	544	592	683	768	
	7	176	217	249	277	305	354	401	294	359	416	466	507	585	658	
Velocità Km/h speed	3,5	293	362	415	462	509	590	669	490	598	693	777	846	975	1097	Litri/ha 
	4	257	317	363	404	445	517	585	429	523	607	680	740	853	960	
	5	205	253	291	323	356	413	468	343	419	485	544	592	683	768	
	6	171	211	242	269	297	344	390	286	349	404	453	493	569	640	
	7	147	181	208	231	254	295	334	245	299	347	389	423	488	549	
Velocità Km/h speed	3,5	230	283	325	361	398	462	523	384	468	543	608	662	763	859	Litri/ha 
	4	201	248	284	316	348	404	458	336	410	475	532	579	668	751	
	5	161	198	227	253	279	323	366	269	328	380	426	463	534	601	
	6	134	165	190	211	232	270	305	224	273	317	355	386	445	501	
	7	115	142	162	181	199	231	262	192	234	271	304	331	382	429	
Litri/min.		31	38	44	49	53	62	70	52	63	73	82	89	102	115	Tab. 3215/0000F
ug. sing.		3,85	4,75	5,45	6,06	6,67	7,75	8,78	6,44	7,85	9,10	10,20	11,10	12,80	14,40	

N.B. to obtain better agitation in the tank, verify that the total lt/min. spray delivery does not exceed 75% of the pump delivery. For example, with an APS 121 select a maximum setting of 86 lt/min.

N.B. to calculate the different ranges extension it is sufficient to multiply the value lt/hectare by the corresponding width indicated in the table and divide it by the new width (see chapter 6.3, page 20).

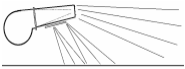
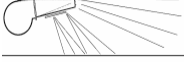
		Tabella erogazione in Litri/ettaro Cannone Ø455 6 getti + 2 laterali														unigreen spa
		Lt./ha spreading rate table for Cannone Blower Ø455 6 NOZZLES + 2 side nozzles														
		Piastrina ceramica Ø1,5							Piastrina ceramica Ø1,8							Gittata
PRESSIONE bar		10	15	20	25	30	40	50	10	15	20	25	30	40	50	spray distance
Velocità Km/h speed	2,5	246	304	349	388	427	496	562	412	502	582	653	710	819	922	Litri/ha 
	3	205	253	291	323	356	413	468	343	419	485	544	592	683	768	
	3,5	176	217	249	277	305	354	401	294	359	416	466	507	585	658	
	4	154	190	218	243	267	310	351	258	314	364	408	444	512	576	
	5	123	152	174	194	214	248	281	206	251	291	326	355	410	461	
Velocità Km/h speed	2,5	211	261	299	333	366	425	481	353	431	499	560	609	702	790	Litri/ha 
	3	176	217	249	277	305	354	401	294	359	416	466	507	585	658	
	3,5	151	186	214	238	262	304	344	252	308	357	400	435	502	564	
	4	132	163	187	208	229	266	301	221	269	312	350	381	439	494	
	5	106	130	149	166	183	213	241	177	215	250	280	304	351	395	
Velocità Km/h speed	2,5	185	228	262	291	320	372	421	309	377	437	490	533	614	691	Litri/ha 
	3	154	190	218	243	267	310	351	258	314	364	408	444	512	576	
	3,5	132	163	187	208	229	266	301	221	269	312	350	381	439	494	
	4	116	143	164	182	200	233	263	193	236	273	306	333	384	432	
	5	92	114	131	146	160	186	211	155	188	218	245	266	307	346	
Litri/min.		31	38	44	49	53	62	70	52	63	73	82	89	102	115	Tab. 3215/0000F
ug. sing.		3,85	4,75	5,45	6,06	6,67	7,75	8,78	6,44	7,85	9,10	10,20	11,10	12,80	14,40	

N.B. to obtain better agitation in the tank, verify that the total lt/min. spray delivery does not exceed 75% of the pump delivery. For example, with an APS 121 select a maximum setting of 86 lt/min.

TABLES FOR CALIBRATING CANNONS

TABLES FOR CALIBRATING CANNONS Ø400-455 TILTING HEAD

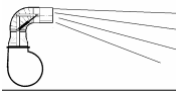
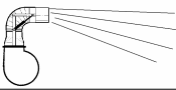
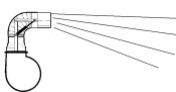
		Tabella erogazione in Litri/ettaro Cannone Ø400 6 getti Testa Snodata														unigreen spa
		Lt./ha spreading rate table for Cannone Blower Ø4005 6 NOZZLES Tilting Head														
		Piastrina ceramica Ø1,8							Piastrina ceramica Ø2							
PRESSIONE bar		10	15	20	25	30	40	50	10	15	20	25	30	40	50	Gittata spray distance
Velocità Km/h speed	3,5	441	538	624	699	761	878	987	480	590	679	761	830	960	1197	Litri/ha 
	4	386	471	546	612	666	768	864	420	516	594	666	726	840	1047	
	5	309	377	437	490	533	614	691	336	413	475	533	581	672	838	
	6	257	314	364	408	444	512	576	280	344	396	444	484	560	698	
	7	221	269	312	350	381	439	494	240	295	339	381	415	480	598	
Velocità Km/h speed	3,5	368	449	520	583	634	731	823	400	491	566	634	691	800	997	Litri/ha 
	4	322	393	455	510	555	640	720	350	430	495	555	605	700	873	
	5	257	314	364	408	444	512	576	280	344	396	444	484	560	698	
	6	214	262	303	340	370	427	480	233	287	330	370	403	467	582	
	7	184	224	260	291	317	366	411	200	246	283	317	346	400	499	
Velocità Km/h speed	3,5	288	351	407	456	496	572	644	313	385	443	496	541	626	780	Litri/ha 
	4	252	307	356	399	434	501	563	274	337	387	434	473	548	683	
	5	201	246	285	319	347	401	451	219	269	310	347	379	438	546	
	6	168	205	237	266	290	334	376	183	224	258	290	316	365	455	
	7	144	176	203	228	248	286	322	157	192	221	248	271	313	390	
Litri/min.		39	47	55	61	67	77	86	42	52	59	67	73	84	105	Tab. 3215/0000F
ug. sing.		6,44	7,85	9,10	10,20	11,10	12,80	14,40	7,00	8,60	9,90	11,10	12,10	14,00	17,45	

N.B. to obtain better agitation in the tank, verify that the total lt/min. spray delivery does not exceed 75% of the pump delivery. For example, with an APS 121 select a maximum setting of 86 lt/min.

N.B. to calculate the different ranges extension it is sufficient to multiply the value lt/hectare by the corresponding width indicated in the table and divide it by the new width (see chapter 6.3, page 20).

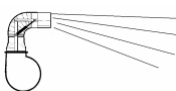
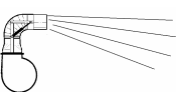
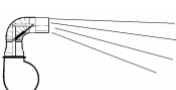
		Tabella erogazione in Litri/ettaro Cannone Ø455 6 getti Testa Snodata														unigreen spa
		Lt./ha spreading rate table for Cannone Blower Ø455 6 NOZZLES Tilting Head														
		Piastrina ceramica Ø1,8							Piastrina ceramica Ø2							
PRESSIONE bar		10	15	20	25	30	40	50	10	15	20	25	30	40	50	Gittata spray distance
Velocità Km/h speed	3,5	331	404	468	525	571	658	741	360	442	509	571	622	720	897	Litri/ha 
	4	290	353	410	459	500	576	648	315	387	446	500	545	630	785	
	5	232	283	328	367	400	461	518	252	310	356	400	436	504	628	
	6	193	236	273	306	333	384	432	210	258	297	333	363	420	524	
	7	165	202	234	262	285	329	370	180	221	255	285	311	360	449	
Velocità Km/h speed	3,5	221	269	312	350	381	439	494	240	295	339	381	415	480	598	Litri/ha 
	4	193	236	273	306	333	384	432	210	258	297	333	363	420	524	
	5	154	188	218	245	266	307	346	168	206	238	266	290	336	419	
	6	129	157	182	204	222	256	288	140	172	198	222	242	280	349	
	7	110	135	156	175	190	219	247	120	147	170	190	207	240	299	
Velocità Km/h speed	3,5	184	224	260	291	317	366	411	200	246	283	317	346	400	499	Litri/ha 
	4	161	196	228	255	278	320	360	175	215	248	278	303	350	436	
	5	129	157	182	204	222	256	288	140	172	198	222	242	280	349	
	6	107	131	152	170	185	213	240	117	143	165	185	202	233	291	
	7	92	112	130	146	159	183	206	100	123	141	159	173	200	249	
Litri/min.		39	47	55	61	67	77	86	42	52	59	67	73	84	105	Tab. 3215/0000F
ug. sing.		6,44	7,85	9,10	10,20	11,10	12,80	14,40	7,00	8,60	9,90	11,10	12,10	14,00	17,45	

N.B. to obtain better agitation in the tank, verify that the total lt/min. spray delivery does not exceed 75% of the pump delivery. For example, with an APS 121 select a maximum setting of 86 lt/min.

TABLE 1-3 TABLES OF DELIVERY OF NOZZLES FOR ATOMISERS

TABLE OF DELIVERY IN LITRES / MIN. MEDIUM AND HIGH VOLUME Ø18 CONICAL NOZZLES FOR ATOMISER							
Ø NOZZLE Ø SLINGER		0,8 1,0	1,0 1,0	1,2 1,2	1,5 1,5	1,8 1,8	2,0 1,8
PRESSURE	10 bar		1,88	2,53	3,85	6,44	7,00
	15 bar	1,14	2,15	3,10	4,75	7,85	8,60
	20 bar	1,31	2,45	3,55	5,45	9,10	9,90
	25 bar	1,43	2,72	3,95	6,06	10,20	11,10
	30 bar	1,55	2,96	4,35	6,67	11,10	12,10
	40 bar	1,74	3,37	5,00	7,75	12,80	14,00
	50 bar	1,93	3,70	5,50	8,78	14,40	17,45
TABLE. 1	Code:	3400/0400F	3400/0401F	3400/0402F	3400/0403F	3400/0404F	3400/0405F



TABLE OF DELIVERY IN LITRES / MIN. LOW VOLUME TXA CONICAL NOZZLES FOR ATOMISER									
NOZZLE TXA80 ISO		LILLAC 005	OLIVE 0067	ORANGE 01	GREEM 015	YELLOW 02	DARKBLUE 03	RED 04	BROWN 05
PRESSURE	5 bar	0,25	0,35	0,51	0,76	1,03	1,53	2,04	2,55
	7 bar	0,30	0,41	0,60	0,90	1,22	1,81	2,41	3,01
	10 bar	0,36	0,49	0,72	1,07	1,45	2,17	2,88	3,60
	12 bar	0,39	0,54	0,78	1,18	1,60	2,38	3,16	3,94
	15 bar	0,44	0,60	0,88	1,31	1,79	2,66	3,53	4,41
	18 bar	0,48	0,66	0,96	1,44	1,96	2,91	3,87	4,82
	20 bar	0,51	0,70	1,01	1,52	2,07	3,07	4,08	5,09
	Code :	3400/0611F	3400/0612F	3400/0613F	3400/0614F	3400/0615F	3400/0616F	3400/0617F	/

TABLE 4-5 TABLES OF DELIVERY OF NOZZLES FOR HAND LANCES

TABLE OF DELIVERY IN LITRES / MIN. OF THE CONICAL NOZZLES FOR LEVER LANCE									
note: standard Ø1,5 nozzle									
DIAMETER NOZZLE			Ø 1,0	Ø 1,2	Ø 1,5	Ø 1,75	Ø 2,0	Ø 2,2	Ø 2,5
PRESSURE (BAR)	JET	CAPACITY (Lt / min)							
	5	cone	1,16	1,40	1,90	2,25	2,65	2,90	3,50
		direct jet	1,40	1,70	2,50	3,95	4,7	6,00	7,70
	8	cone	1,40	1,80	2,60	2,80	3,40	3,65	4,45
		direct jet	1,70	2,20	3,40	4,85	6,00	7,60	9,80
	10	cone	1,50	1,96	2,90	3,10	3,90	4,10	5,00
		direct jet	1,90	2,40	3,75	5,40	6,95	8,55	11,0
	15	cone	1,88	2,40	3,40	3,80	4,50	5,00	6,10
		direct jet	2,30	3,00	4,50	6,65	8,30	10,4	13,4
	30	cone	2,60	3,40	4,80	5,40	6,30	7,10	8,70
		direct jet	3,20	4,20	6,40	9,40	11,7	14,7	19,1
TABLE. 4 50	cone	3,40	4,40	6,20	6,80	8,10	9,20	11,2	
	direct jet	4,10	5,40	8,30	11,8	15,1	19,1	24,6	

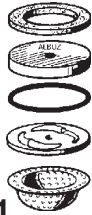
TABLE OF DELIVERY IN LITRES / MIN. OF THE CONICAL NOZZLES FOR MITRA SPRAY GUN										
note: standard Ø2,5 nozzle										
DIAMETER NOZZLE			Ø 1,0	Ø 1,2	Ø 1,5	Ø 1,8	Ø 2,0	Ø 2,3	Ø 2,5	Ø 3,0
PRESSURE (BAR)	JET	CAPACITY (Lt / min)								
	15	cone	2,45	3,60	4,60	5,90	6,90	8,10	9,20	11,5
		direct jet	2,50	3,80	5,10	7,30	8,80	10,8	13,0	18,4
	25	cone	3,00	4,25	5,70	7,20	8,10	10,2	11,4	14,4
		direct jet	3,10	4,60	6,50	9,30	11,7	14,1	16,4	24,1
	35	cone	3,40	4,70	6,60	8,50	10,2	12,9	14,0	18,0
		direct jet	3,50	5,40	7,40	10,8	13,4	16,8	19,1	28,2
	40	cone	3,55	5,20	6,90	9,20	10,9	13,7	14,5	18,8
		direct jet	3,65	5,90	7,80	11,7	14,3	17,9	21,0	30,1
	TABLE. 5 50	cone	4,00	5,60	7,70	10,5	12,5	14,9	16,4	20,9
		direct jet	4,10	6,30	8,60	12,7	15,8	19,7	23,0	33,0

TABLE 7 TABLE OF PROGRAMMED MAINTENANCE

OPERATION	8 h	50 h	300 h	END OF SEASON
Check the level and state of the oil	0			
Check the accumulator pressure		0		
Check the suction (hoses, pipes, unions)		0		
Check and clean the suction and delivery filters	0			
Check the pump fixing feet and screws in general		0		
Check the diaphragm and the oil and change if necessary			X (1)	X (2)
Check the suction/delivery valves			X	X
Check the pump screws and bolts are tight				X
Check and clean the nozzles and the non-drip diaphragm	0			
Check the wear of the nozzles			0	
Check the hydraulic oil level		0		
Check any failures or cracking of the welds, especially on herbicide booms				0
Grease the articulated joints and the wheel hubs		0		
Check the tyre pressure		0		

NOTE: 0 Operation to be carried out by the operator
X Operation to be carried out by a specialised technician or in an authorised workshop
(1) First oil change
(2) Change at the same time a changing the diaphragm

TABLE 8 PROBLEMS, CAUSES AND SOLUTIONS

PROBLEMS	CAUSES	SOLUTIONS
The pump won't charge	Air suction	Check the suction system
	Adjustment valve closed (Command group isn't at zero pressure)	Position the lever correctly
	Valves and/or valve seats suction and delivery worn or dirty	Replace or clean (*)
The pump doesn't reach the set pressure	Valve and/or valve seat adjustment worn	Replace (*)
	Valves and/or valve seats suction and delivery worn or dirty	Replace or clean (*)
	Insufficient rpm	Bring speed up to correct rpm always in the field of 350 ÷ 550 rpm.
	The nozzles used are worn or have holes that are too big	Replace
Irregular pressure (with impulses)	Suction blocked	Clean the cartridge of the filter or remove the blockage
	Valves and/or valve seats suction and delivery worn or dirty	Replace or clean (*)
Excessive vibrations at delivery	Air suction	Check the suction system
	Pressure accumulator discharged or incorrect air pressure	Bring the air pressure back up to the right value (see pump handbook) (*)
Noisiness and the level of the oil has dropped	Blocked suction	Check the suction system
Water in the oil	Breakage of one or more diaphragms	Replace (*) If the replacement isn't done immediately, drain the water out of the pump and introduce clean oil without water (also used) or diesel to stop rust attacking the internal parts
No liquid comes out of the nozzles	Delivery filter dirty Non-drip filters dirty Nozzles blocked	Clean

NOTE: (*) Only specialised technician

2007 TAB. 14 a FITTING		TYPE OF MACHINE	ATOMIZZATORI PORTATI													
			PLT													
			<i>Truck-mounted mistblowers</i>													
EXPO P			EXPO A			EXPO M										
201 301 402			300 400 600			300 410		400 400		600 600		800				
FUN GROUP	" " Ø500 NYLON	X	X	X												
	" " Ø600 NYLON	X	X	X				X	X	X						
	" " Ø650 NYLON				X	X										
	" " Ø700 NYLON										X	X				
	" " Ø750 NYLON						X									
	" " Ø800 NYLON												X	X		
	" " Ø800TV NYLON												X	X		
POMPE COMET	PUMP APS 41	X	X	X												
	" " APS 51				X	X	X	X	X							
	" " APS 71		X	X			X	X	X	X						
	" " APS 96 - IDS960										X	X				
	" " APS 101															
	" " APS 121												X	X		
PUMPS ANNOVI REVERBERI	PUMP AR 30															
	" " AR 503	X	X	X	X	X	X	X	X	X						
	" " AR 813 - 903		X	X			X			X	X	X	X	X		
	" " AR 1064-1053										X	X	X	X		
	" " AR 1265-1203															
PISTON PUMPS	PUMP T 55															
	" " T 77															
PRESSURE REGULATOR	GCP 3 WAY / Sirius	X	X	X	X	X	X	X	X	X	X					
	" RVA 2-4-5 WAY	X	X	X	X	X	X	X	X	X	X	X	X	X		
	" RM 40 S	X	X	X	X	X	X	X	X	X	X	X	X	X		
	GCP Electric						X					X	X	X		
JETS	SINGLE NON-DRIP	X	X	X	X	X	X	X	X	X	X	X	X	X		
	DOUBLE NON-DRIP	X	X	X	X	X	X	X	X	X	X	X	X	X		
NOZZLES	CERAM. CONICAL Ø 18	X	X	X	X	X	X	X	X	X	X	X	X	X		
	CERAM. CONICAL ISO	X	X	X	X	X	X	X	X	X	X	X	X	X		
	ALBUZ CERAM. ATR	X	X	X	X	X	X	X	X	X	X	X	X	X		
	TOP DEF.	X	X	X	X	X	X	X	X	X	X	X	X	X		
	HAND WASH	X	X	X	X	X	X	X	X	X	X	X	X	X		
	CIRCUIT WASHER				X	X	X	X	X	X	X	X	X	X		
	ROT. IDR. 30°															
	LEAF PROTECTION	X	X	X				X	X	X	X	X	X	X		
	SINGLE SIDE FOR OLIVES				X	X	X	X	X	X	X					
WEIGHT in Kg X10	EMPTY MAX FITINGS	160	190	190	190	210	270	200	270	230	230	260	260	420		
	FULL MAX FITINGS	390	540	630	570	680	970	550	750	730	730	990	990	1440		
P HP	POWER NECESSARY	22	22	22	35	35	45	30	30	30	37	37	53	53		

TAB.15A ALLOWED FITTINGS

2007		ATOMIZZATORI PORTATI con PULEGGIA <i>Truck-mounted mistblowers with BELT DRIVE</i>					ATOMIZZATORI PORTATI con MOLTIPLICATORE <i>Tractor-mounted mistblowers with GEARBOX</i>								
TAB. 15 a FITTING	TYPE OF MACHINE Nominal capacity	DEVIL - P AP-DP					DEVIL - TGZ AP - TGZ			SIRIO - EOLO AP - A					
		200	300	300	400	400	200	300	400	300	300	400	400	600	
		FAN GROUP	Swivel Ø600 NYLON TV	X	X		X								
	" " Ø650 NYLON								X			X			
	" " Ø700 NYLON TV			X											
	" " Ø750 NYLON TV													X	
	" " Ø650 NY TGZ						X	X	X		X		X		
PUMPS COMET	" " APS 51	X	X	X	X	X	X	X	X	X	X	X	X		
	" " APS 71	X	X	X	X	X	X	X	X	X	X	X	X	X	
	" " APS 96													X	
PUMPS ANNOVI REVERBERI	PUMP AR 503	X	X	X	X	X	X	X	X	X	X	X	X		
	" " AR 813 - 903	X	X	X	X	X	X	X	X	X	X	X	X	X	
	" " AR 1064 - 1053													X	
PRESSURE REGULATOR	GCP RVA	X	X	X	X	X	X	X	X	X	X	X	X	X	
	ORION Comet	X	X	X	X	X	X	X	X	X	X	X	X	X	
	GCP ELECTRIC	X	X	X	X	X	X	X	X	X	X	X	X	X	
JETS	SINGLE NON-DRIP	X	X	X	X	X	X	X	X	X	X	X	X	X	
	DOUBLE NON-DRIP														
	TRIPLE NON-DRIP	X	X	X	X	X	X	X	X	X	X	X	X	X	
NOZZLES	CERAM. CONICAL Ø 18	X	X	X	X	X	X	X	X	X	X	X	X	X	
	CERAM. CONICAL ISO	X	X	X	X	X	X	X	X	X	X	X	X	X	
	CERAM. CONICAL ATR	X	X	X	X	X	X	X	X	X	X	X	X	X	
	DEF. TOP	X	X	X	X	X				X	X	X	X	X	
	TOP DEF. + 2 JETS	X	X	X	X	X					X		X	X	
	HAND WASH	X	X	X	X	X	X	X	X	X	X	X	X	X	
	CIRCUIT WASHER	X	X	X	X	X	X	X	X	X	X	X	X	X	
	LEAF PROTECTION	X	X	X	X	X	X	X	X	X	X	X	X	X	
TOTAL MASS in Kg	EMPTY MAX FITINGS	170	200	200	210	210	200	230	240	190	190	210	210	270	
	FULL MAX FITINGS	430	580	580	690	690	460	610	700	560	560	680	680	970	
P HP	POWER NECESSARY	35	35	40	35	40	45	45	45	35	35	35	35	50	

TAB.16A ALLOWED FITTINGS

2007 TAB. 16 a FITTING		TYPE OF MACHINE	ATOMIZZATORI PORTATI A CANNONE <i>Tractor-mounted mistblowers "Cannon Type"</i>							
			EOLO C - SIRIO C APC				BORA - APC APC			
			Nominal capacity (lt.)		300	400	600	600	800	800
FAN GROUP	CENTRIFUGAL Ø450/27	X	X							
	" " Ø400 /38			X		X		X		
	" " Ø455 /75				X		X			X
PUMPS COMET	PUMP APS 51	X	X							
	" " APS 71					X		X		
	" " APS 96 - IDS960			X		X		X		
	" " APS121				X		X			X
	" " APS145 - IDS1401				X		X			X
PUMPS ANNOVI REVERBERI	PUMP AR 503	X	X							
	" " AR 813 - 903					X		X		
	" " AR 1064 - 1053					X		X		
	" " AR 1265 - 1203			X	X		X			X
	" " BHA 160				X		X			X
PRESSURE REGULATOR	RVA	X	X	X	X	X	X	X	X	X
	ORION Comet			X	X	X	X	X	X	X
	GCP ELECTRIC			X	X	X	X	X	X	X
JETS	P 39	X	X							
	SINGLE NON-DRIP	X	X	X	X	X	X	X	X	X
	DOUBLE NON-DRIP	X	X	X	X	X	X	X	X	X
	TYRE MFC	X	X							
NOZZLES	CERAM. CONICAL	X	X	X	X	X	X	X	X	X
	CERAM. CONICAL ISO	X	X	X	X	X	X	X	X	X
	CERAM. CONICAL ATR	X	X	X	X	X	X	X	X	X
	CIRCUIT WASHER	X	X	X	X	X	X	X	X	X
	HAND WASH	X	X	X	X	X	X	X	X	X
	HYD. ROTAT 30°	X	X	X	X	X	X	X	X	X
	HYD. ROTAT 70°	X	X	X	X	X	X	X	X	X
	HYD. ROTAT 180°			X	X	X	X	X	X	X
	SWIVEL HEAD			X	X	X	X	X	X	X
	HYD. HEAD			X	X	X	X	X	X	X
TOTAL MASS in Kg	EMPTY MAX FITINGS	240	250	340	340	420	460	420	460	
	FULL MAX FITINGS	620	720	810	1050	1380	1430	1580	1630	
P. HP	POWER NECESSARY	33	33	50	90	50	90	50	90	

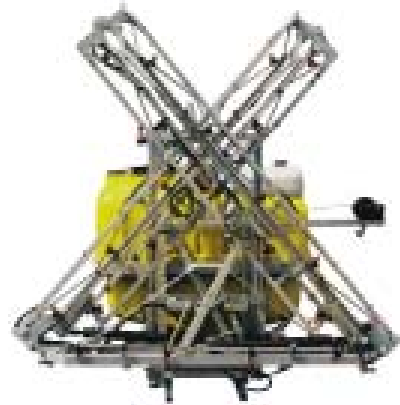

unigreen[®]
S.p.A.
C R O P P R O T E C T I O N

via Rinaldi, 105 - Loc. Cavazzoli (Reggio Emilia) - ITALY

Tel. +39 0522 369811

Fax. +39 0522 369898

e-mail: info@unigreen-spa.com

internet: www.unigreen-spa.com

member of the **YAMAHA** group



Descriptions, indicative illustrations, UNIGREEN S.P.A. reserves the right to make variations or modifications without prior warning.

Free Manuals Download Website

<http://myh66.com>

<http://usermanuals.us>

<http://www.somanuals.com>

<http://www.4manuals.cc>

<http://www.manual-lib.com>

<http://www.404manual.com>

<http://www.luxmanual.com>

<http://aubethermostatmanual.com>

Golf course search by state

<http://golfingnear.com>

Email search by domain

<http://emailbydomain.com>

Auto manuals search

<http://auto.somanuals.com>

TV manuals search

<http://tv.somanuals.com>